



US00D897346S

(12) **United States Design Patent**
Claudepierre et al.

(10) **Patent No.:** **US D897,346 S**
(45) **Date of Patent:** **** Sep. 29, 2020**

- (54) **STYLUS LOOP ASSEMBLY INCLUDING A STYLUS LOOP, STYLUS, AND COMPUTER**
- (71) Applicant: **Google LLC**, Mountain View, CA (US)
- (72) Inventors: **Vincent Claudepierre**, San Francisco, CA (US); **Christophe Koch**, Santa Cruz, CA (US); **Joseph Tsao**, Grandview, MO (US)
- (73) Assignee: **Google LLC**, Mountain View, CA (US)
- (**) Term: **15 Years**
- (21) Appl. No.: **29/649,425**
- (22) Filed: **May 30, 2018**
- (51) **LOC (12) Cl.** **14-02**
- (52) **U.S. Cl.**
USPC **D14/440**
- (58) **Field of Classification Search**
USPC D14/440, 447, 250, 432; 206/45.23, 320, 206/45.2; 361/679.55; 294/25; 224/218
CPC G06F 1/1628; G06F 1/1626; A47B 23/044
See application file for complete search history.

5,743,414	A *	4/1998	Baudino	B43K 23/001
					211/69.1
D410,951	S *	6/1999	Schwarzwaelder	D19/135
6,016,248	A *	1/2000	Anzai	G06F 1/1626
					361/679.59
D479,477	S *	9/2003	Perezon	D10/74
D508,954	S *	8/2005	Cetera	D19/65
D522,583	S *	6/2006	Goserud	D19/78
7,270,308	B1 *	9/2007	Mohr	B43K 23/02
					248/309.1
D573,652	S *	7/2008	Esfahani	D19/81
D598,052	S *	8/2009	Esfahani	D19/81
D603,904	S *	11/2009	Esfahani	D19/81
D620,981	S *	8/2010	Sturken	D19/81
D645,505	S *	9/2011	Melnick	D19/2
D658,187	S	4/2012	Diebel		
D676,449	S *	2/2013	Probst	D14/440
D696,253	S	12/2013	Akana et al.		
D696,669	S	12/2013	Akana et al.		
D703,209	S	4/2014	Marcus		
D713,402	S	9/2014	Akana et al.		
D723,036	S *	2/2015	Longo	D14/411
D729,801	S *	5/2015	Daniel	D14/307
D752,593	S	3/2016	Diebel		
9,327,544	B2 *	5/2016	Ceruzzi	B43K 23/001
D765,085	S *	8/2016	Moore	D14/440
D766,711	S *	9/2016	Babbage	D8/394
D768,638	S *	10/2016	Lee	D14/440
D769,370	S *	10/2016	Moeck	D19/204
D770,457	S	11/2016	Massucco et al.		
D773,454	S	12/2016	Akana et al.		
D784,995	S	4/2017	Akana et al.		
D786,238	S	5/2017	Roberts		
D788,108	S *	5/2017	Cai	D14/411
D789,941	S	6/2017	Sauvage et al.		
D792,884	S	7/2017	Nyholm		
D794,120	S *	8/2017	Takemura	D19/81
D800,725	S	10/2017	Akana et al.		
D807,365	S	1/2018	Liu		
D808,394	S	1/2018	Lakraa et al.		
D808,950	S	1/2018	Miele et al.		
D811,409	S *	2/2018	Zhong	D14/432
D820,838	S	6/2018	Akana et al.		
D823,942	S *	7/2018	Frankel	D19/81
D832,256	S *	10/2018	King	D14/432
D834,582	S *	11/2018	Zhuang	D14/440
D837,793	S	1/2019	Ham et al.		
D839,271	S *	1/2019	King-Murrey	D14/432
D847,140	S *	4/2019	Chapuis	D14/440
D847,820	S *	5/2019	Pisapia	D14/447
D852,199	S *	6/2019	Kim	D14/440
D852,270	S *	6/2019	Sirichai	D19/81
D857,023	S	8/2019	Hyun		

(56) **References Cited**

U.S. PATENT DOCUMENTS

D168,491	S *	12/1952	Alvarez	D19/81
D212,479	S *	10/1968	Price	D19/77
D228,239	S *	8/1973	Bryce	D19/83
4,199,884	A *	4/1980	Loof	G09F 3/04
					40/316
4,984,529	A *	1/1991	Dickson	B42D 9/007
					116/234
D321,913	S *	11/1991	Wolff	D20/22
5,467,952	A *	11/1995	Martin	A47B 21/0371
					248/118.1
5,477,619	A *	12/1995	Kearns	B25H 7/04
					33/27.03
D366,146	S *	1/1996	Bertrand	D19/78
5,572,941	A *	11/1996	Amos	A47B 21/0371
					112/475.06
D385,299	S *	10/1997	Adams	D14/342

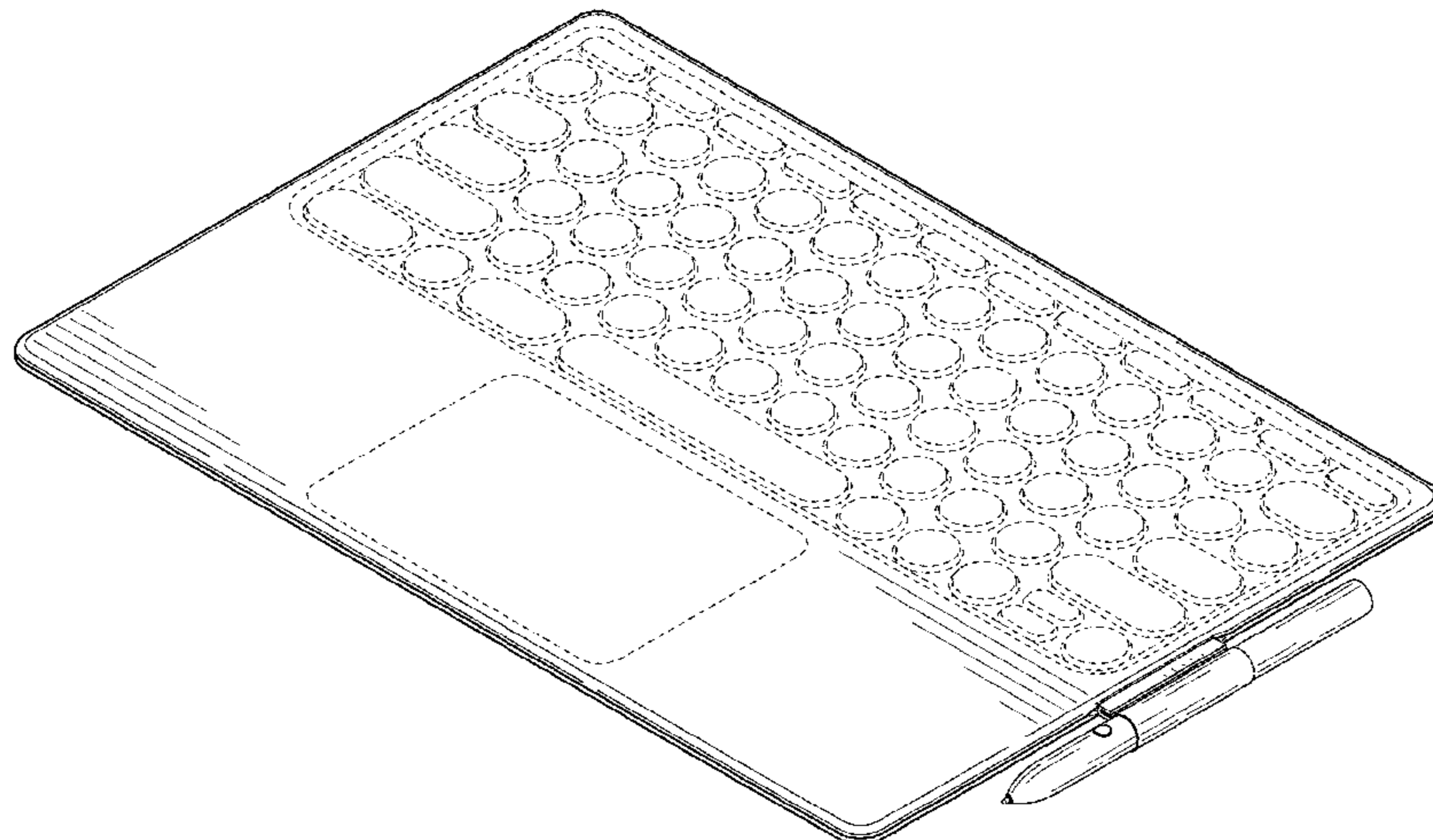

2002/0036253	A1 *	3/2002	Lake	B43K 23/002 248/205.3
2005/0055861	A1 *	3/2005	McAnulty	G09F 3/20 40/654.01
2005/0274641	A1 *	12/2005	Baranoff	206/461
2006/0124487	A1 *	6/2006	Brown	B43K 23/001 206/371
2008/0024388	A1	1/2008	Bruce	
2008/0167095	A1	7/2008	Kim et al.	
2009/0159763	A1	6/2009	Kim	
2009/0194209	A1	8/2009	De et al.	
2011/0305496	A1 *	12/2011	Jolani	B43K 23/001 401/6
2012/0268891	A1	10/2012	Cencioni	
2012/0308981	A1	12/2012	Libin et al.	
2013/0088431	A1	4/2013	Ballagas et al.	
2013/0223005	A1	8/2013	Smith et al.	
2013/0233762	A1	9/2013	Balaji et al.	
2013/0241381	A1	9/2013	Dukerschein et al.	
2013/0334385	A1 *	12/2013	Steck	A63B 29/024 248/231.9
2014/0246340	A1	9/2014	Jiang et al.	
2015/0065208	A1	3/2015	Balaji et al.	
2015/0151887	A1	6/2015	Huang	
2015/0237979	A1	8/2015	Huang	
2015/0263776	A1	9/2015	Shyu et al.	
2015/0266610	A1	9/2015	Melmon et al.	
2015/0280768	A1	10/2015	Huang	
2016/0123525	A1 *	5/2016	Nguyen	A45F 5/00 248/534
2017/0097698	A1 *	4/2017	Maeshima	G06F 3/03545

FOREIGN PATENT DOCUMENTS

AU	366856	1/2016
JP	1485391 S	12/2013
JP	1563511 S	3/2016
JP	1547736	4/2016
JP	HJ2802750700	8/2016
JP	1561006 S	10/2016
JP	1562100 S	10/2016
JP	1573144 S	4/2017
JP	1602027 S	4/2018
JP	1628151	4/2019
KR	3006743410000	12/2012
KR	3008018220007	7/2015
KR	3008018220008	7/2015
KR	3008018220009	7/2015
TW	D149031	9/2012
TW	D185609	9/2012
TW	D150033	11/2012
TW	M443891 U	12/2012
TW	D152708	4/2013
TW	D168347	6/2015
TW	D169480	8/2015
TW	D185980	10/2017

OTHER PUBLICATIONS

Chrome Unboxed. "Pixelbook Pen Loop Installation." Feb. 15, 2018. YouTube Video. Can be viewed online at <<https://www.youtube.com/watch?v=ifl0rDBYKgw>>.

Design Examination Report No. 1 for Australian Design Patent Application No. 201815555 dated Feb. 27, 2019. 13 pages.

Google Image Search for "Stylus Holder Loop" conducted by the Australian Patent Examiner in Design Examination Report No. 1 dated Feb. 27, 2019 for AU design patent application No. 201815555. 1 page.

Lora, Krystal. "Google Pixel Slate Unboxing!" Nov. 27, 2018. YouTube Video. Can be viewed online at: <<https://www.youtube.com/watch?v=JkTpexvCZ0c>>.

Whitwam, Ryan. "Pixelbook." Jan. 18, 2018. 1 page. Retrieved from the Internet: <<https://www.androidpolice.com/2018/01/18/google-offering-free-pen-loop-anyone-bought-pixelbook/>>.

Ødegård, Andreas. "Add a stylus holder to your tablet for \$2." Feb. 19, 2011. 1 page. Retrieved from the Internet: <<https://www.pocketables.com/2011/02/add-a-stylus-holder-to-your-tablet-for-2.html>>.

Ødegård, Andreas. "From the DIY drawer: Accessory attachment system for cases [Video]." Mar. 13, 2013. 1 page. Retrieved from the Internet: <<https://www.pocketables.com/2013/03/from-the-diy-drawer-accessory-attachment-system-for-cases.html>>.

Notification from Japanese Patent Office for Application No. 2018-020359 dated Mar. 26, 2019.

Sony, Digital Paper DPT-S1, p. 1, Apr. 28, 2016.

Taiwanese Office Action and Search Report for Application No. 107305658 dated Sep. 27, 2019.

Examination Report for Canada Application No. 183505, dated Jul. 4, 2019 3 pages.

Examination Report for Canada Application No. 183507, dated Jul. 4, 2019 2 pages.

Office Action for JP Design Application No. 2019003761, dated Aug. 20, 2019 4 pages (with English Translation).

ROC (Taiwan) Search Report for Design Patent Application No. 107305660 dated Aug. 29, 2019.

ROC Taiwan Office Action and Search Report for Application No. 108304969 dated Nov. 27, 2019.

ROC Taiwan Office Action and Search Report for Application No. 108304974 dated Nov. 28, 2019.

ROC Taiwan Office Action and Search Report for Application No. 108304975 dated Nov. 27, 2019.

ROC Taiwan Office Action and Search Report for Application No. 108304976 dated Nov. 27, 2019.

Taiwanese Office Action for Application No. 107305659 dated Sep. 27, 2019.

* cited by examiner

Primary Examiner — Cynthia R Underwood
(74) Attorney, Agent, or Firm — Botos Churchill IP Law

(57) CLAIM

The ornamental design for a stylus loop assembly including a stylus loop, stylus, and computer, as shown and described.

DESCRIPTION

The present application is related to U.S. Design patent application Ser. No. 29/649,419, entitled CONVERTIBLE LAPTOP COMPUTER, and to U.S. Design patent application Ser. No. 29/649,420, entitled ADJUSTABLE FOLIO, both filed concurrently herewith, the entire disclosures of which are incorporated herein by reference.

FIG. 1 is a top perspective view of the stylus loop assembly including a stylus loop, stylus, and computer according to a first state of use of our design, in which the stylus loop is connected to a keyboard portion of a computer;

FIG. 2 is a front elevation view thereof;

FIG. 3 is a rear elevation view thereof;

FIG. 4 is a right side elevation view thereof;

FIG. 5 is a left side elevation view thereof;

FIG. 6 is a top elevation view thereof;

FIG. 7 is a bottom elevation view thereof;

FIG. 8 is a top perspective view of the stylus loop assembly including a stylus loop, stylus, and computer according to a second state of use of our design, in which the stylus loop is disconnected from a keyboard portion of a computer;

FIG. 9 is a front elevation view thereof;

FIG. 10 is a rear elevation view thereof;

FIG. 11 is a right side elevation view thereof;

FIG. 12 is a left side elevation view thereof;

FIG. 13 is a top elevation view thereof;

FIG. 14 is a bottom elevation view thereof;

FIG. 15 is a top perspective view of the stylus loop assembly including a stylus loop, stylus, and computer according to a

fourth state of use of our design, in which the stylus loop containing the stylus is connected to a keyboard portion of a computer;

FIG. 16 is a front elevation view thereof;

FIG. 17 is a rear elevation view thereof;

FIG. 18 is a right side elevation view thereof;

FIG. 19 is a left side elevation view thereof;

FIG. 20 is a top elevation view thereof;

FIG. 21 is a bottom elevation view thereof;

FIG. 22 is a top perspective view of the stylus loop assembly including a stylus loop, stylus, and computer according to a fifth state of use of our design, in which the stylus loop containing the stylus is disconnected from a keyboard portion of a computer;

FIG. 23 is a front elevation view thereof;

FIG. 24 is a rear elevation view thereof;

FIG. 25 is a right side elevation view thereof;

FIG. 26 is a left side elevation view thereof;

FIG. 27 is a top elevation view thereof;

FIG. 28 is a bottom elevation view thereof;

FIG. 29 is a top perspective view of the stylus loop assembly including a stylus loop, stylus, and computer according to a sixth state of use of our design, illustrating the stylus loop;

FIG. 30 is a front elevation view thereof;

FIG. 31 is a rear elevation view thereof;

FIG. 32 is a right side elevation view thereof;

FIG. 33 is a left side elevation view thereof;

FIG. 34 is a top elevation view thereof;

FIG. 35 is a bottom elevation view thereof;

FIG. 36 is a top perspective view of the stylus loop assembly including a stylus loop, stylus, and computer according to a ninth state of use of our design, illustrating the stylus loop containing the stylus;

FIG. 37 is a front elevation view thereof;

FIG. 38 is a rear elevation view thereof;

FIG. 39 is a right side elevation view thereof;

FIG. 40 is a left side elevation view thereof;

FIG. 41 is a top elevation view thereof; and,

FIG. 42 is a bottom elevation view thereof.

Broken lines are environmental only and form no part of the claimed design.

The brackets in FIGS. 8-14 and FIGS. 22-28 are included only to show the association of elements in the figures, and form no part of the claimed design.

1 Claim, 22 Drawing Sheets

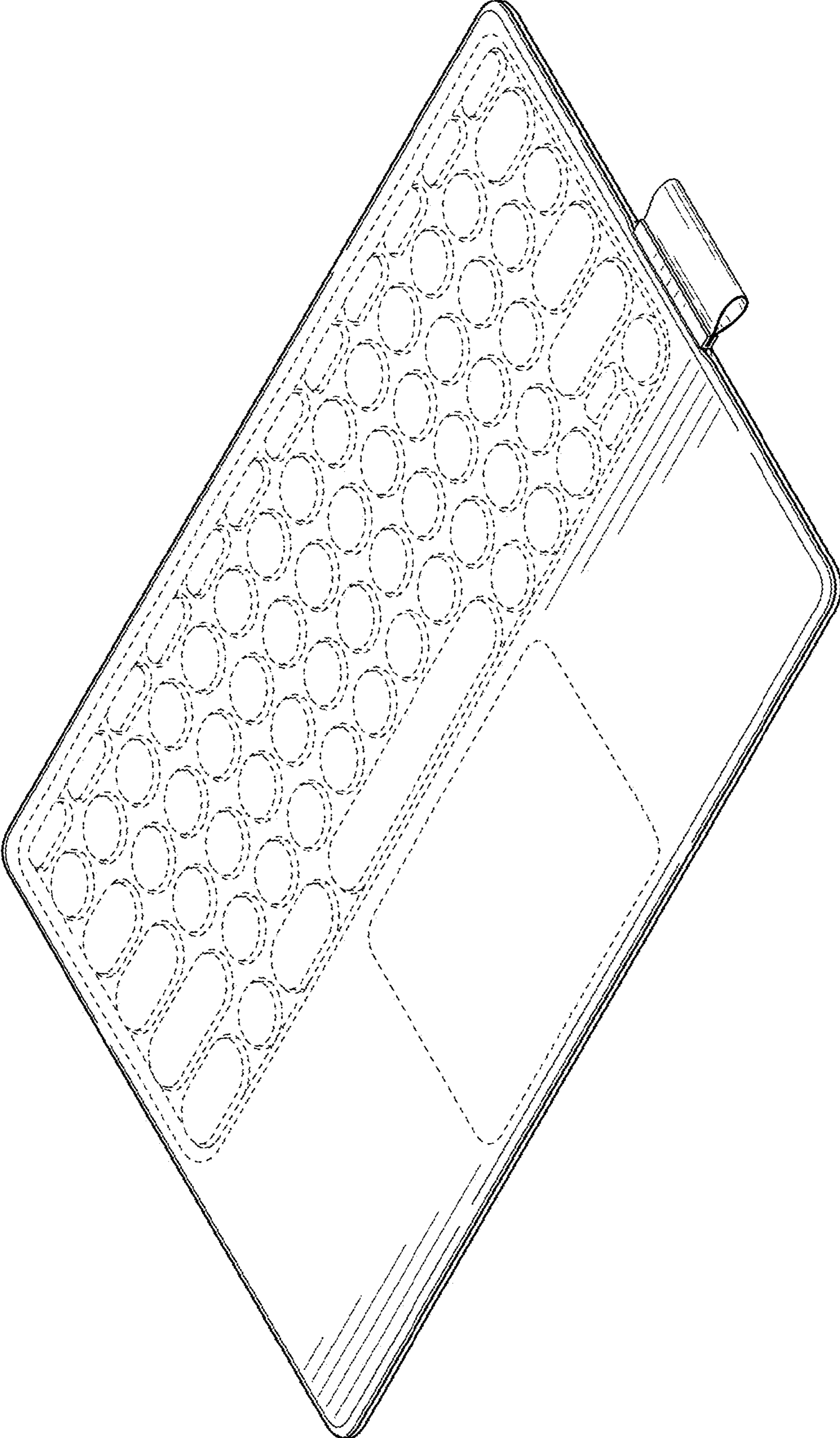

FIG. 1

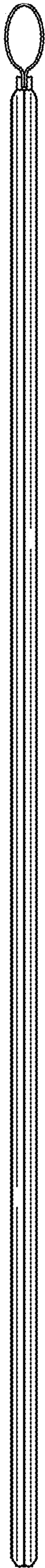

FIG. 2



FIG. 3



FIG. 4



FIG. 5

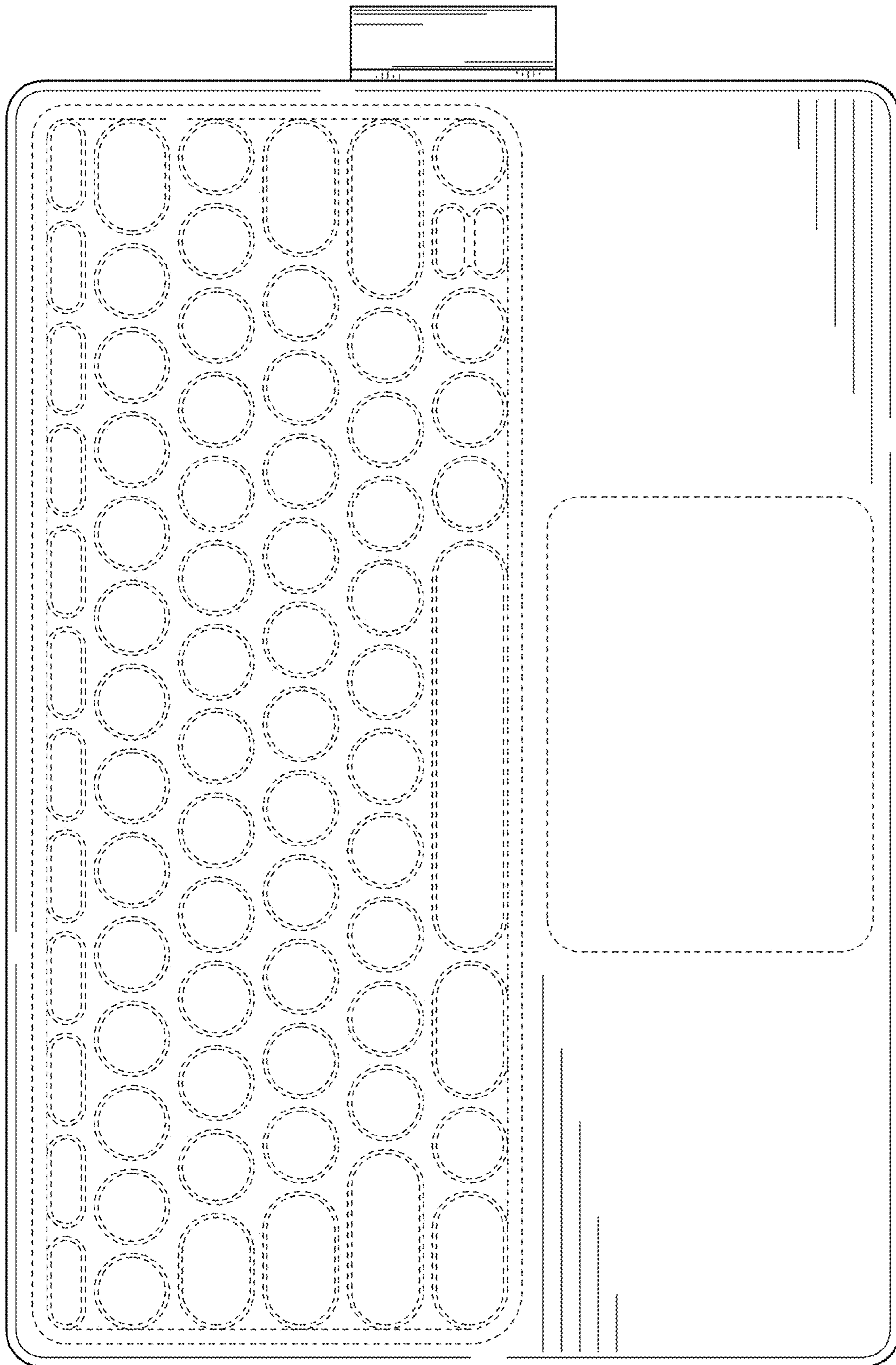

FIG. 6

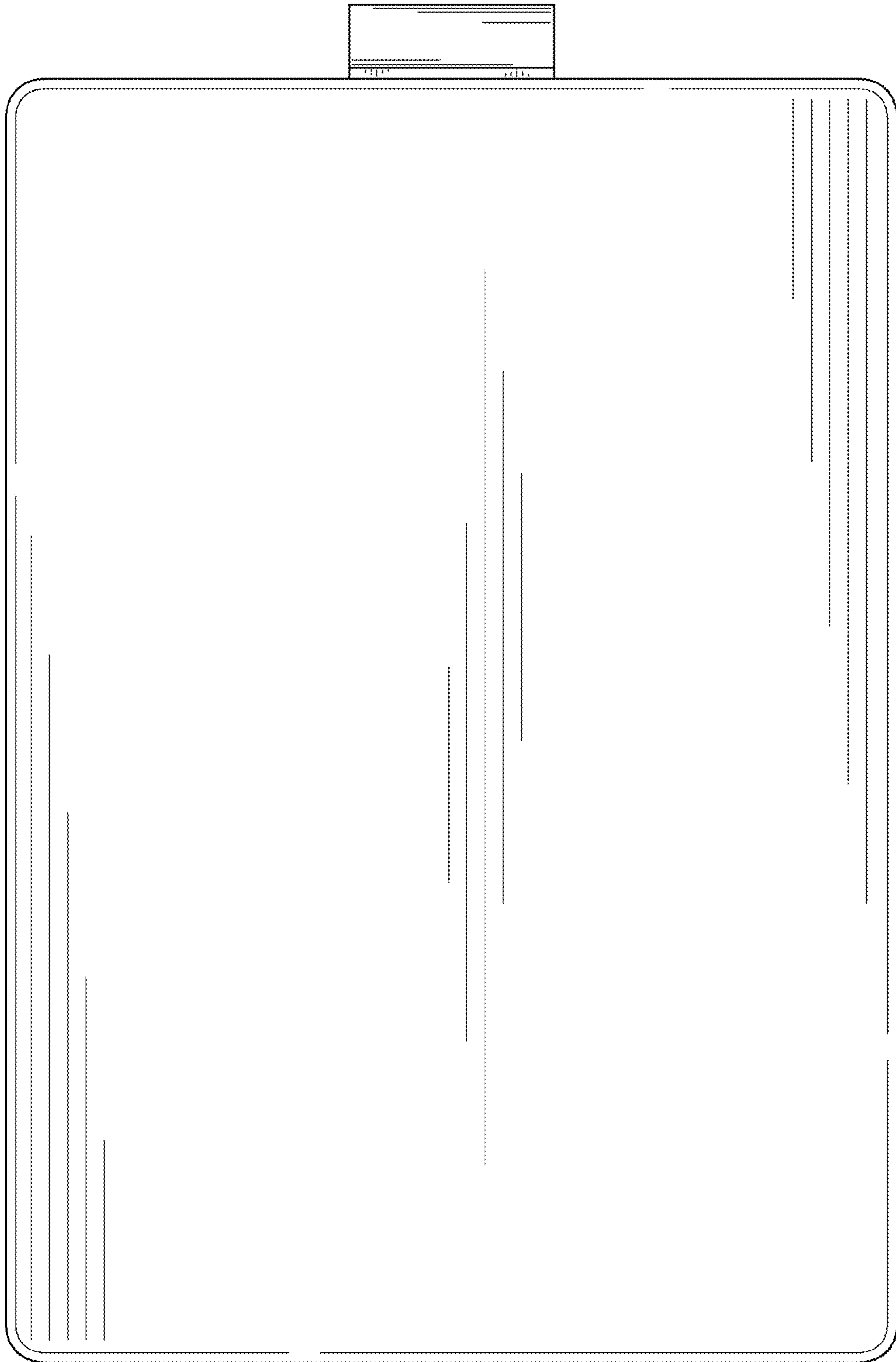

FIG. 7

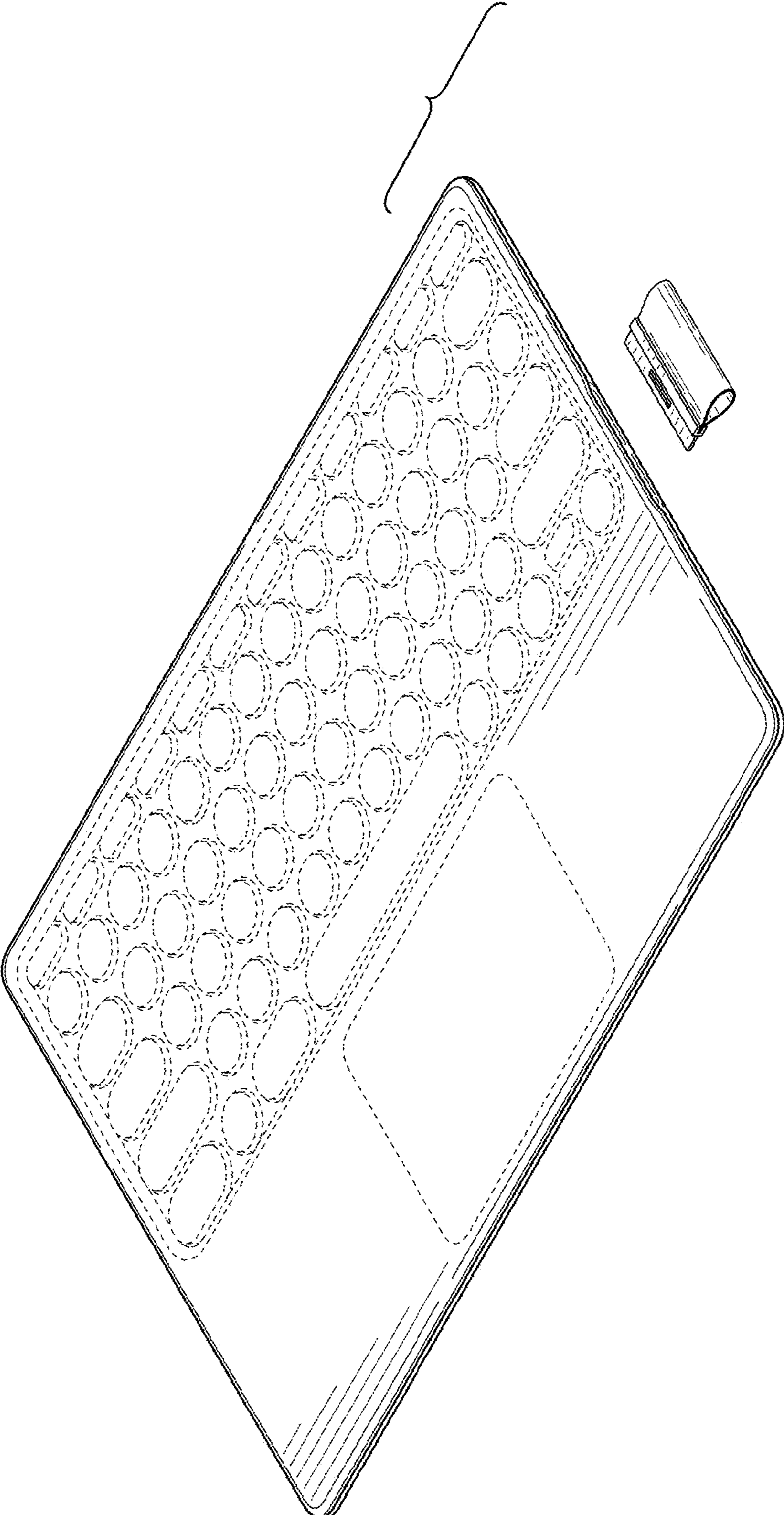

FIG. 8

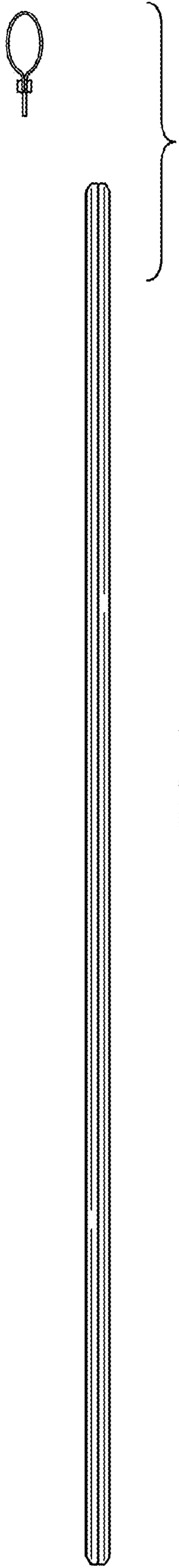

FIG. 9

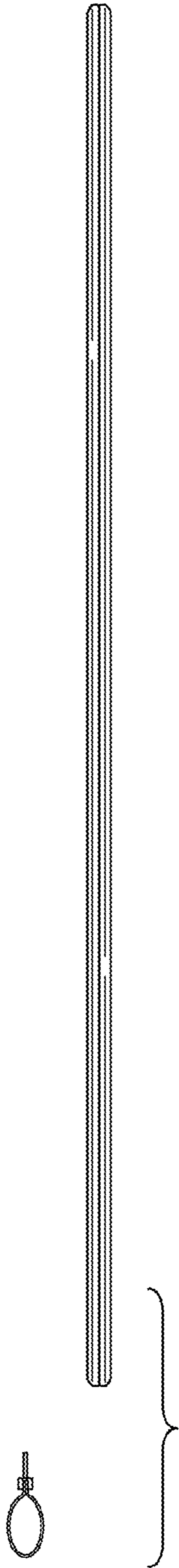

FIG. 10

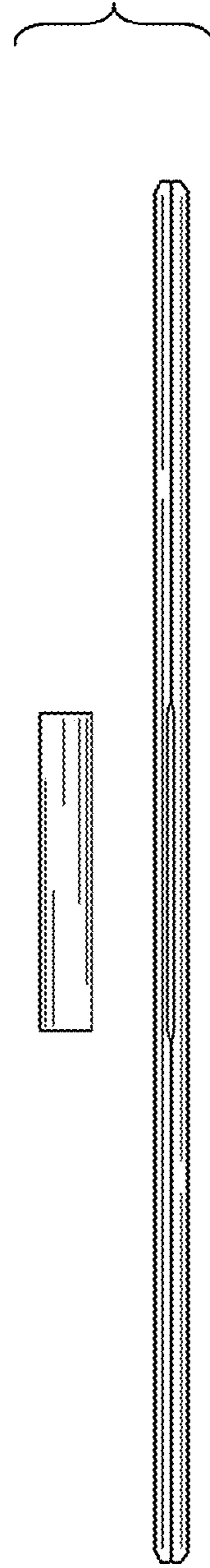

FIG. 11

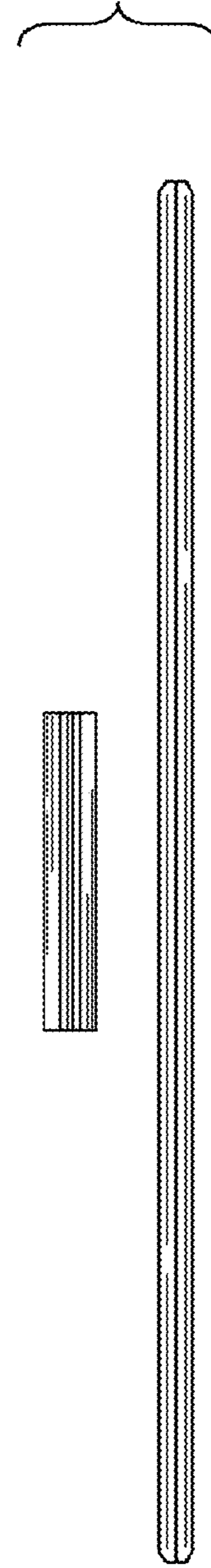

FIG. 12

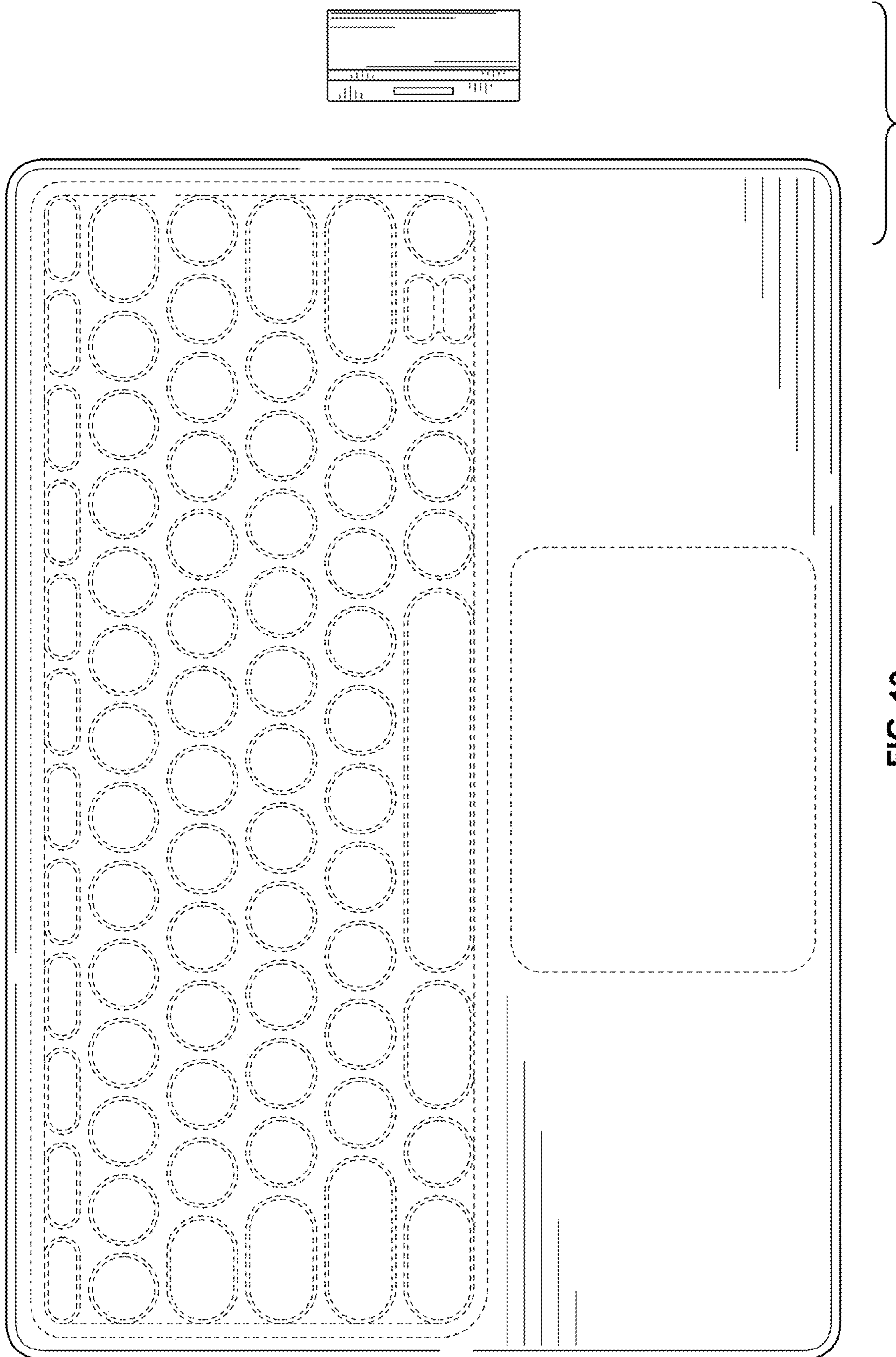

FIG. 13

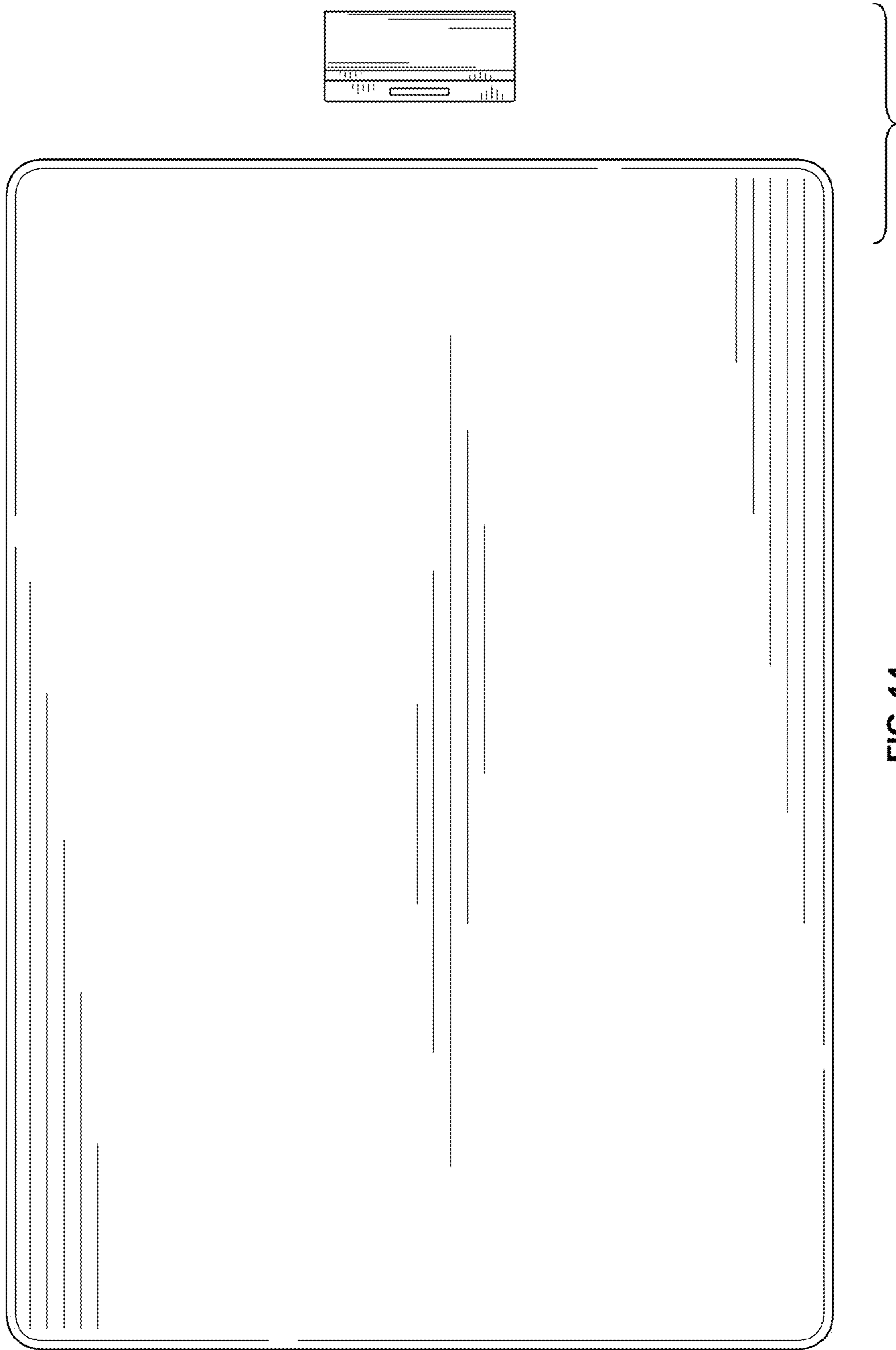

FIG. 14

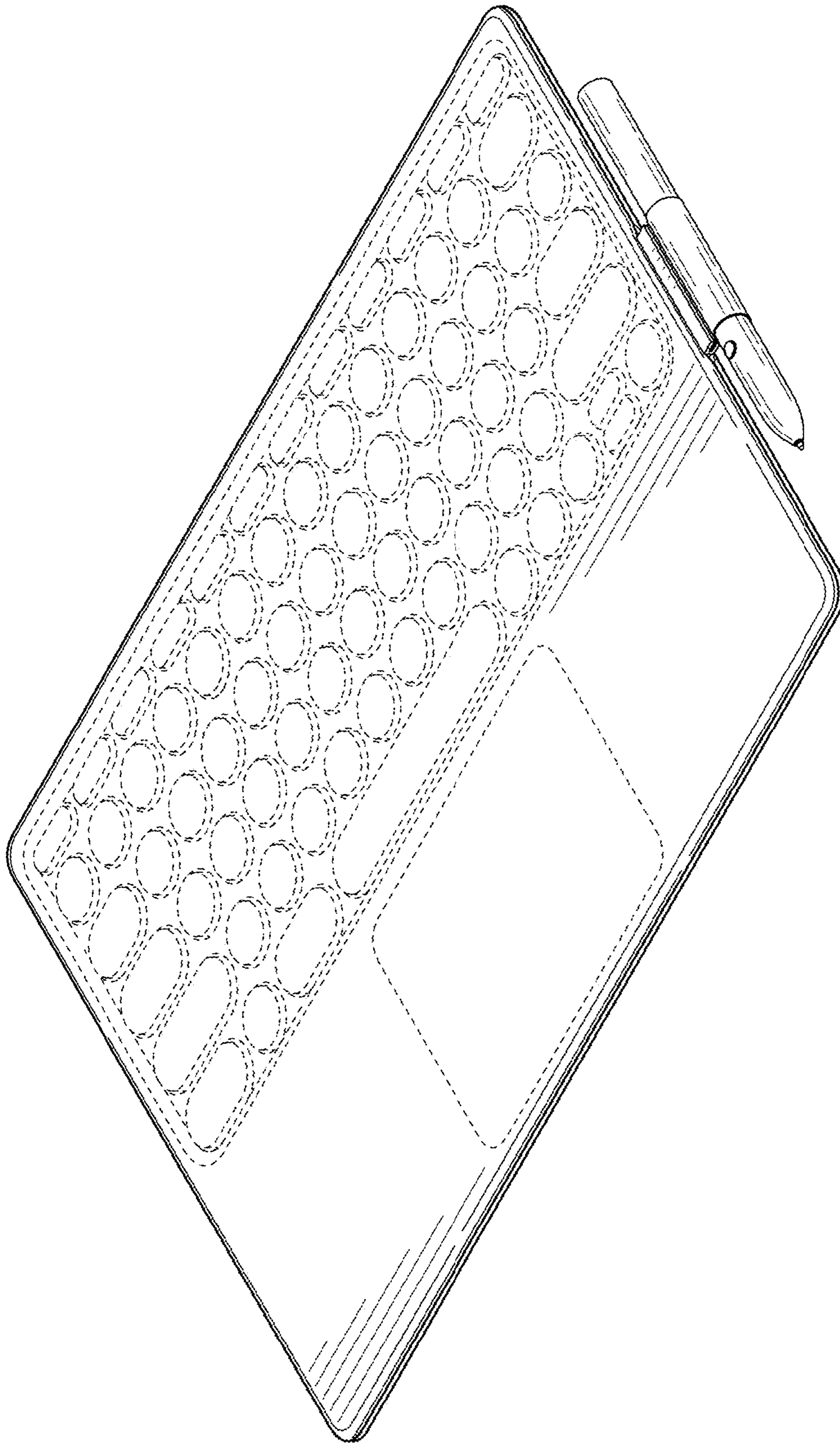

FIG. 15

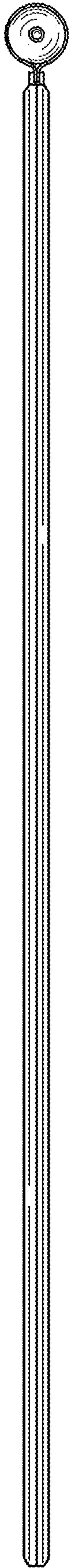

FIG. 16

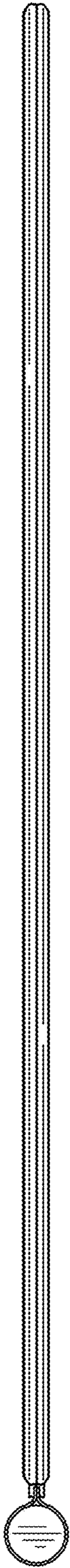

FIG. 17

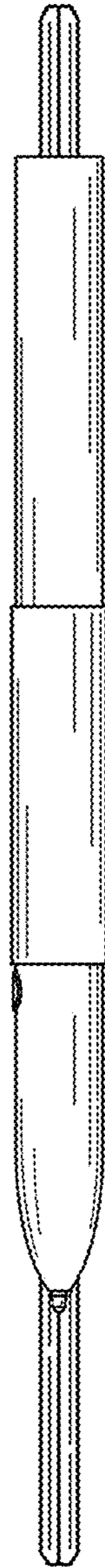

FIG. 18

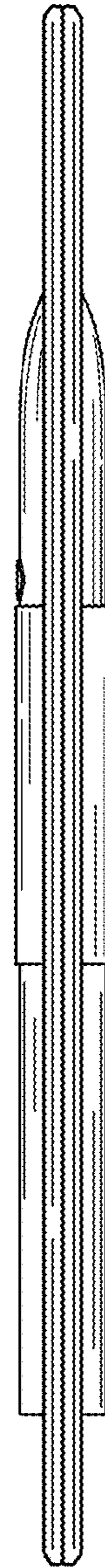

FIG. 19

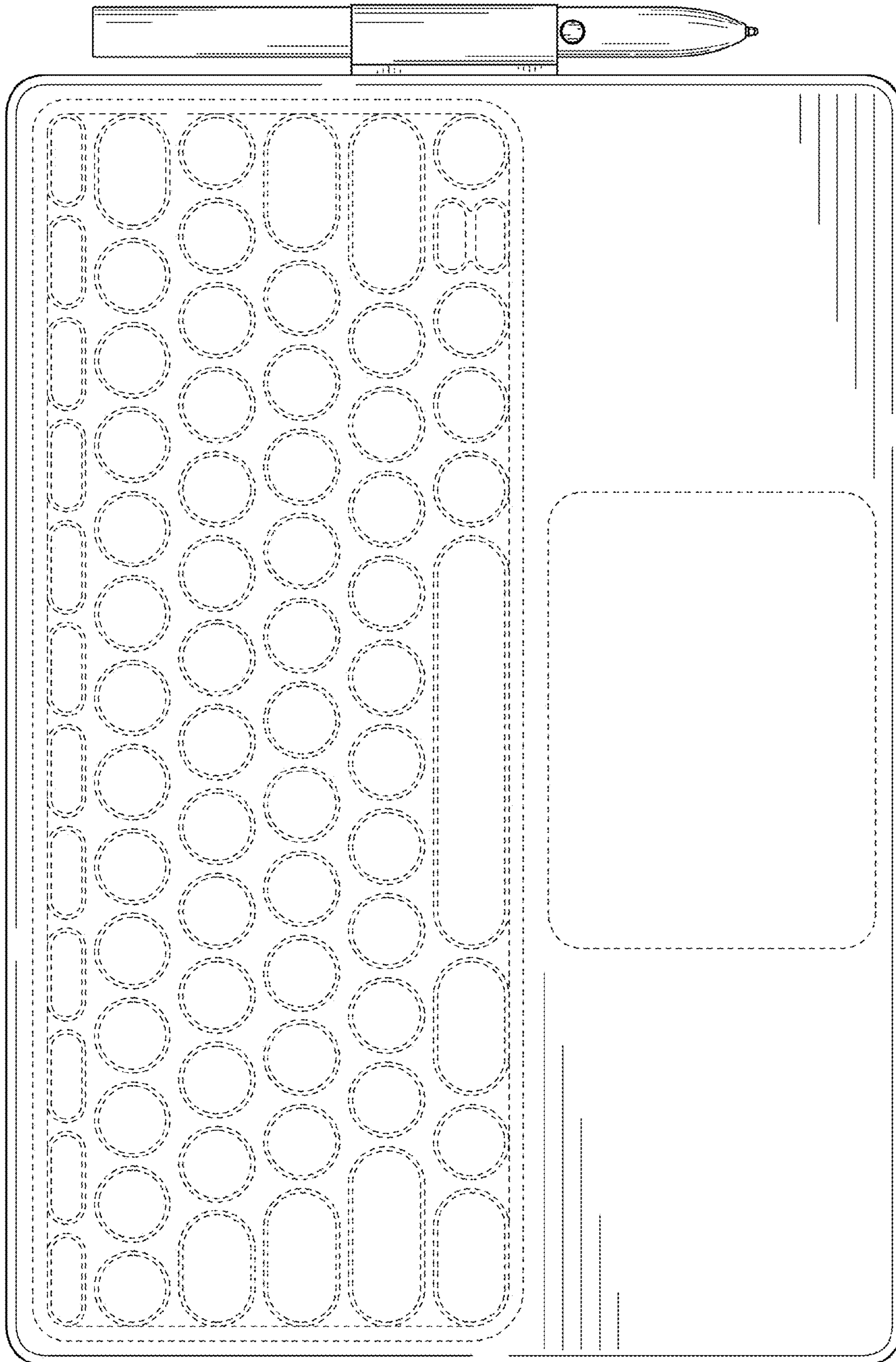

FIG. 20

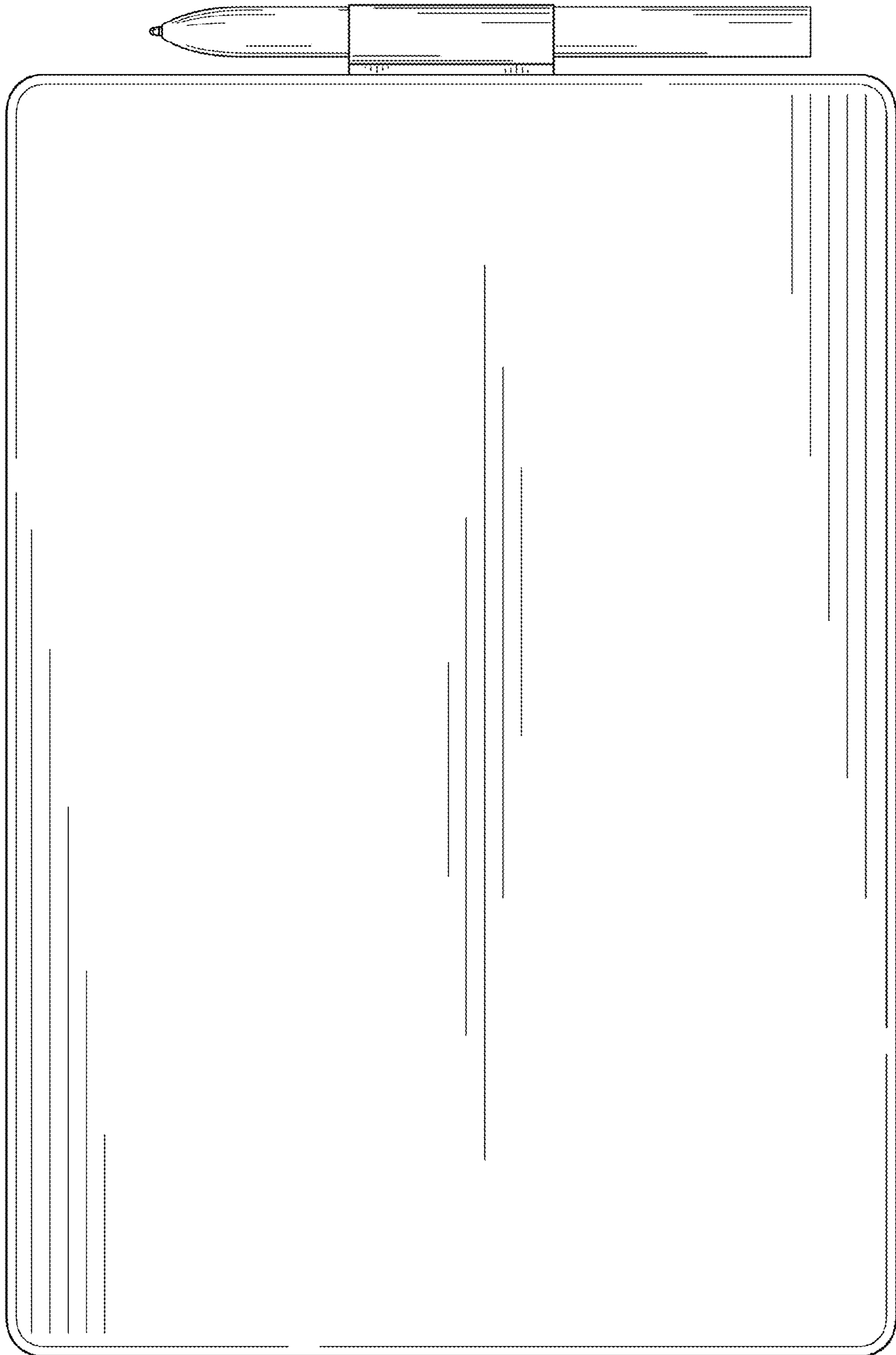

FIG. 21

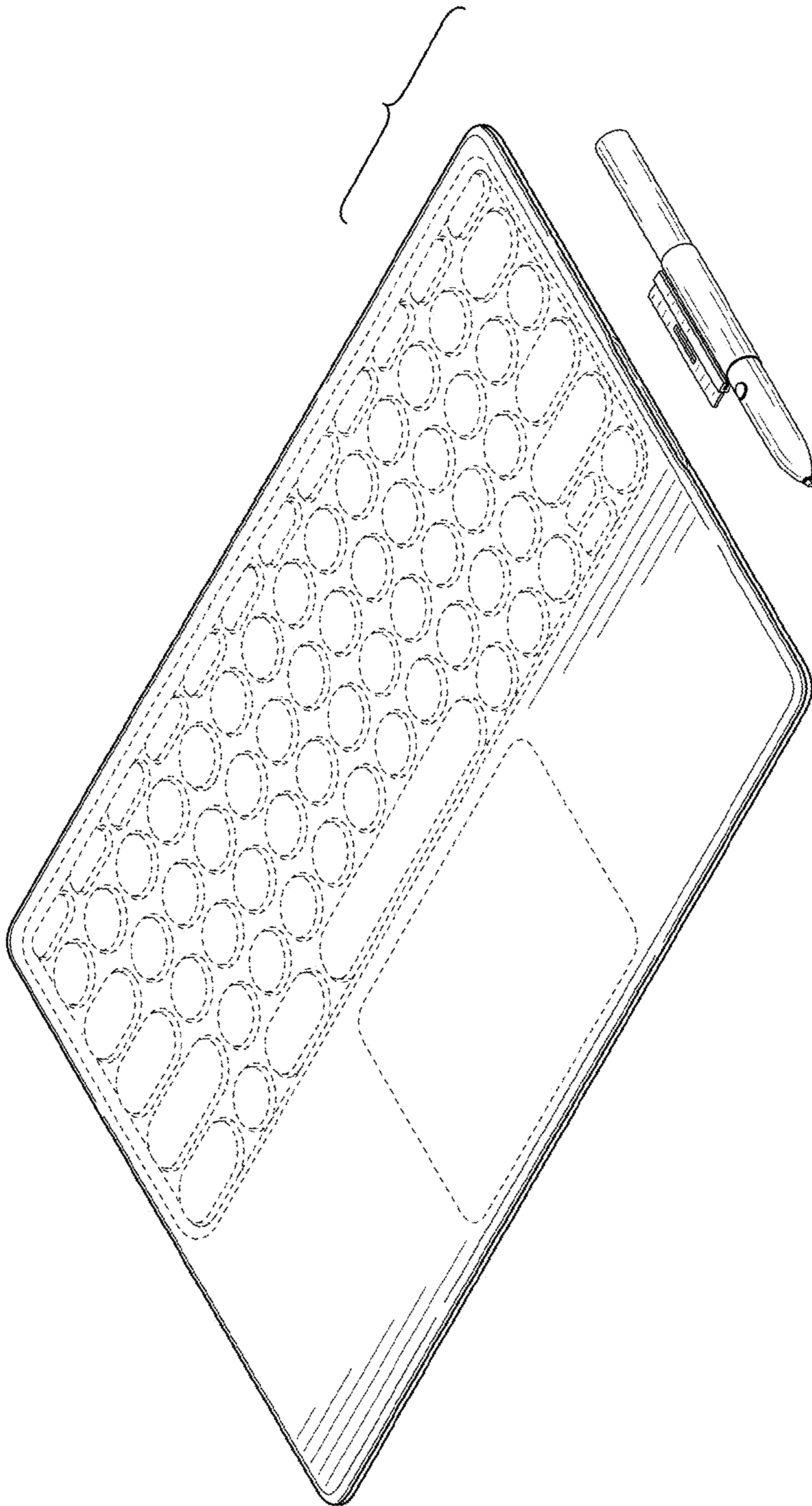

FIG. 22



FIG. 23

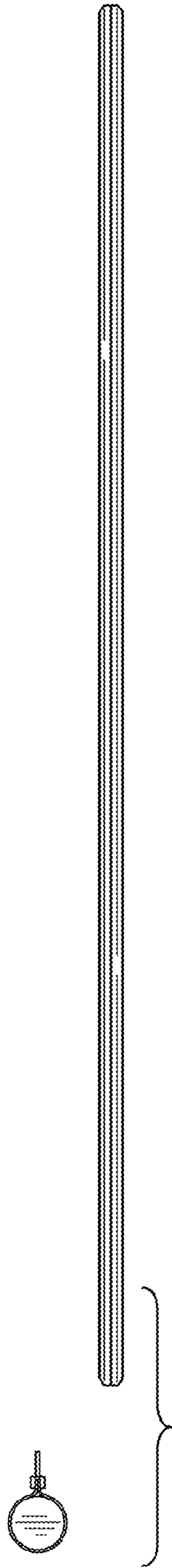

FIG. 24

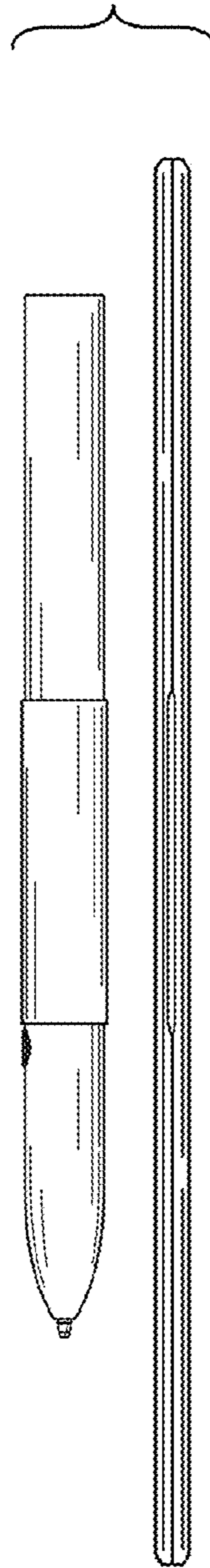

FIG. 25

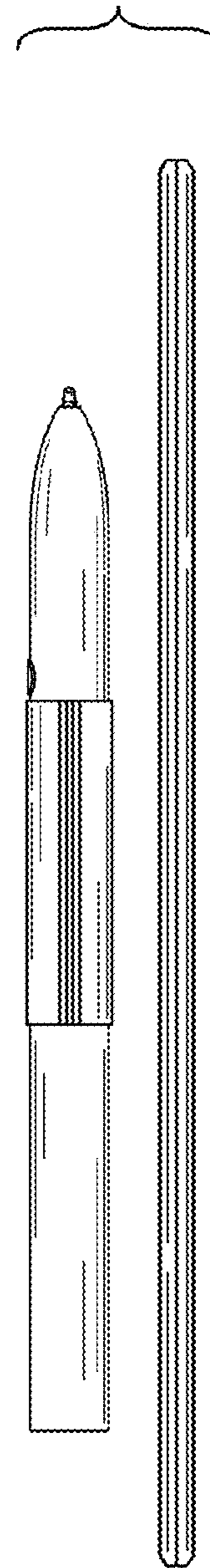

FIG. 26

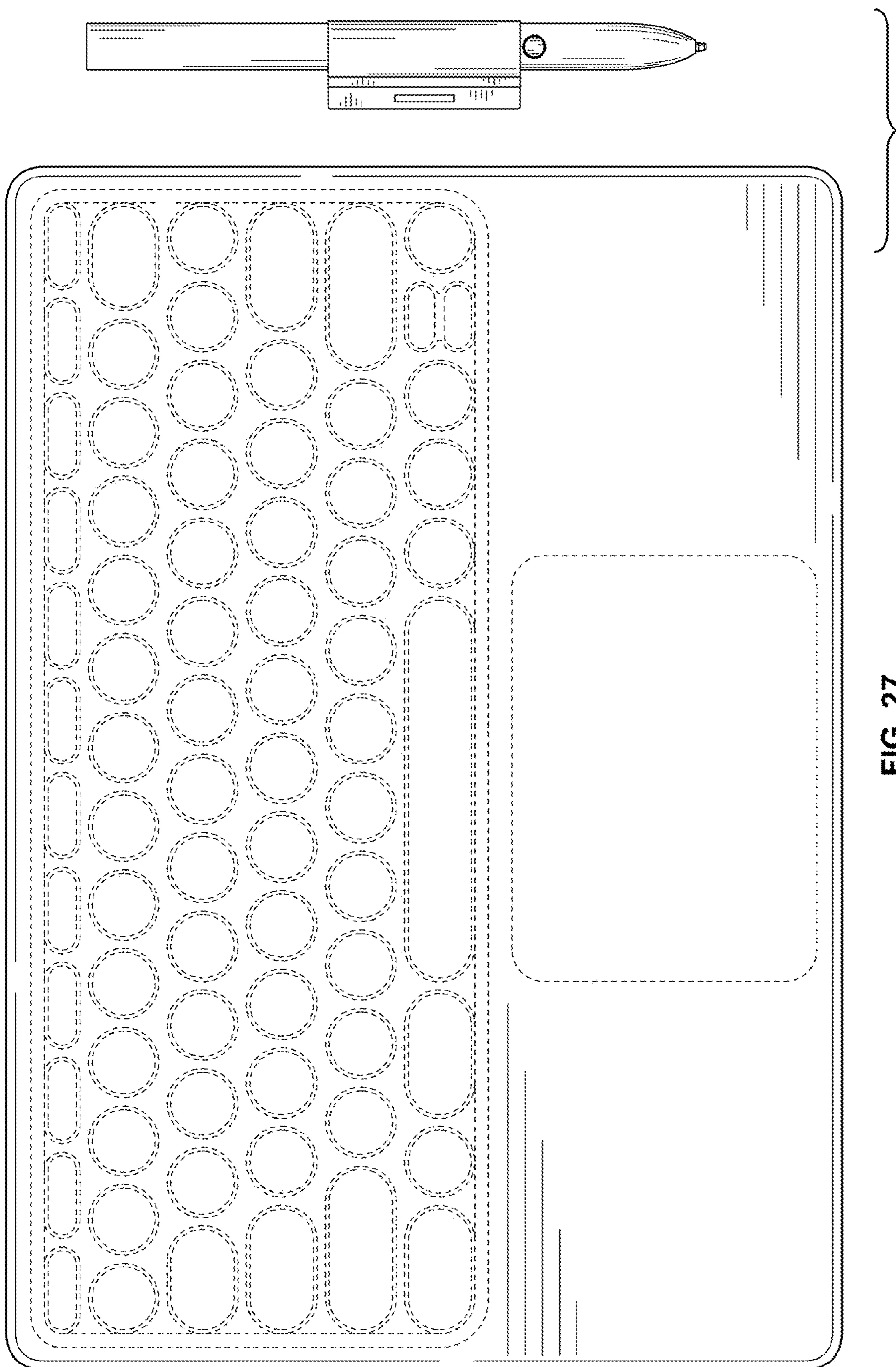

FIG. 27

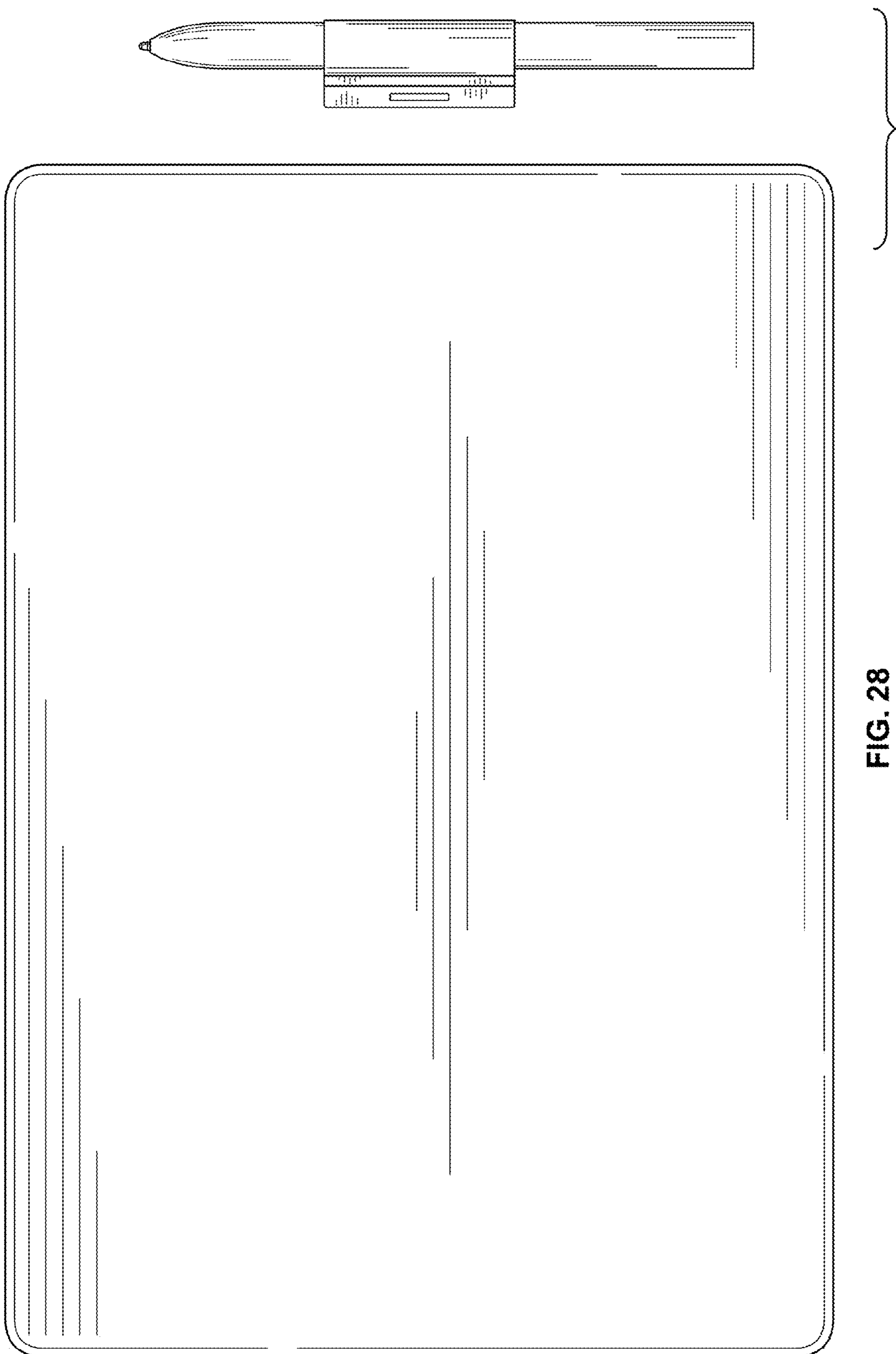

FIG. 28

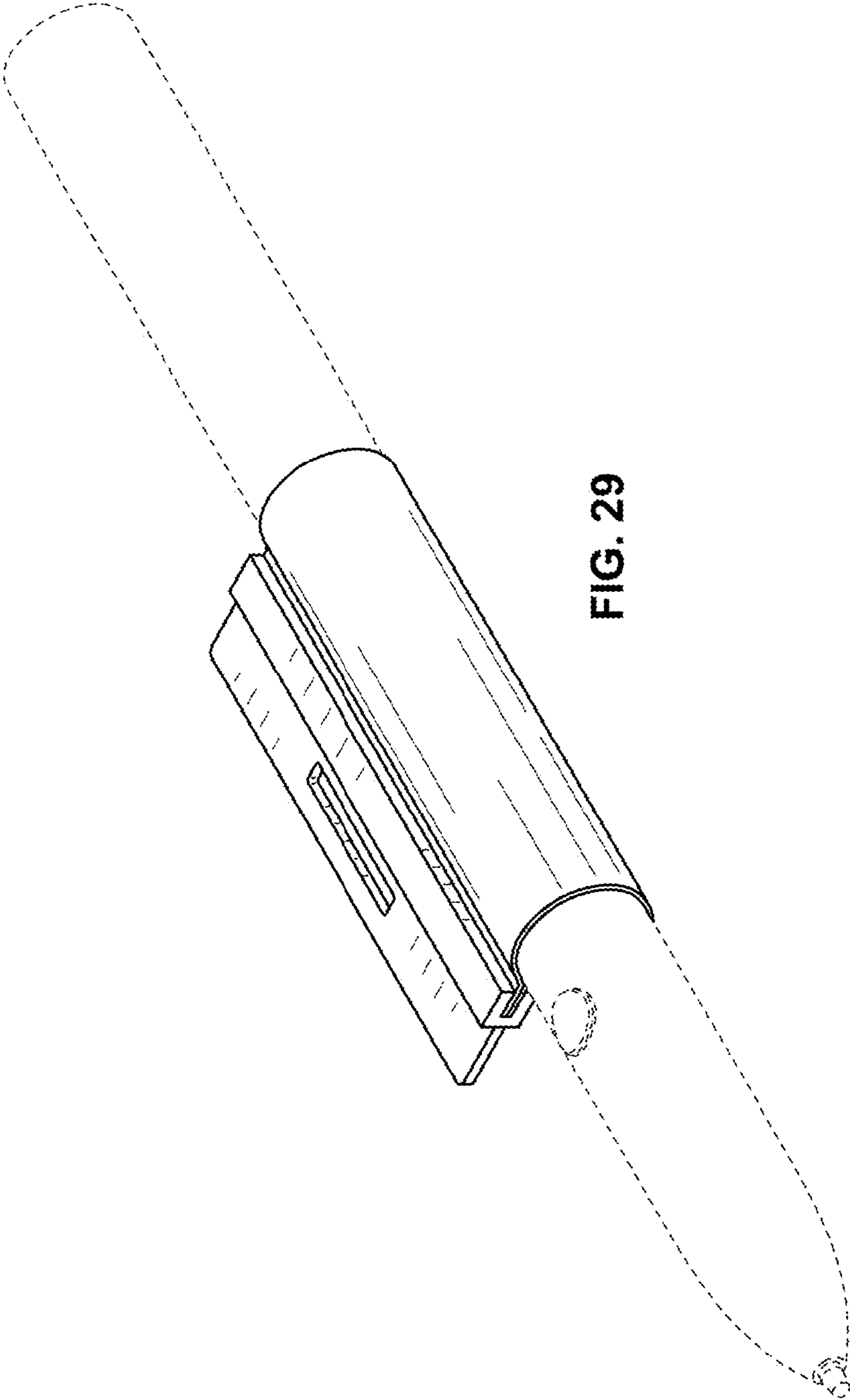

FIG. 29

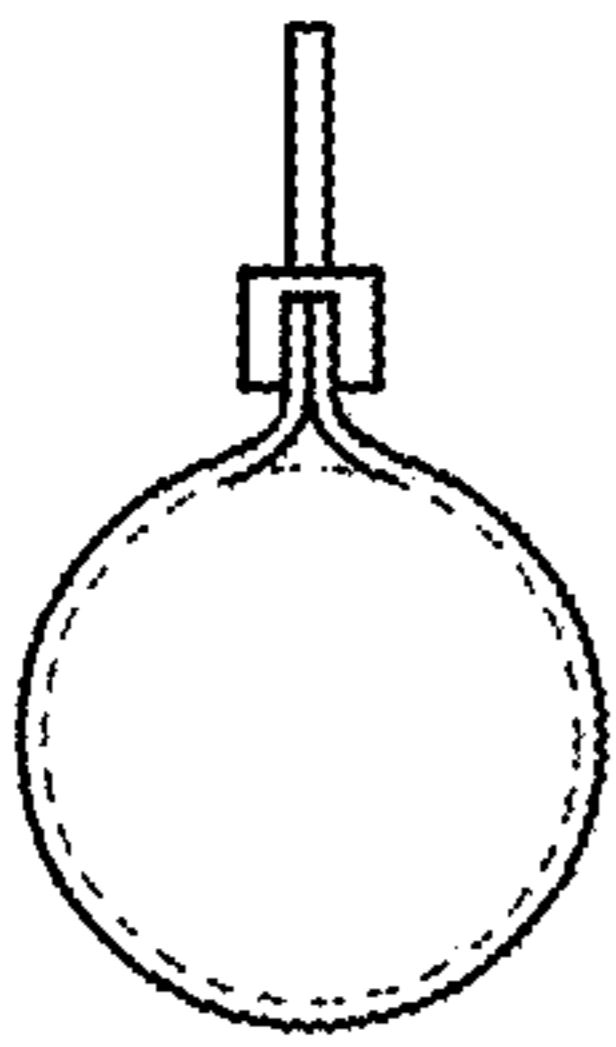

FIG. 31

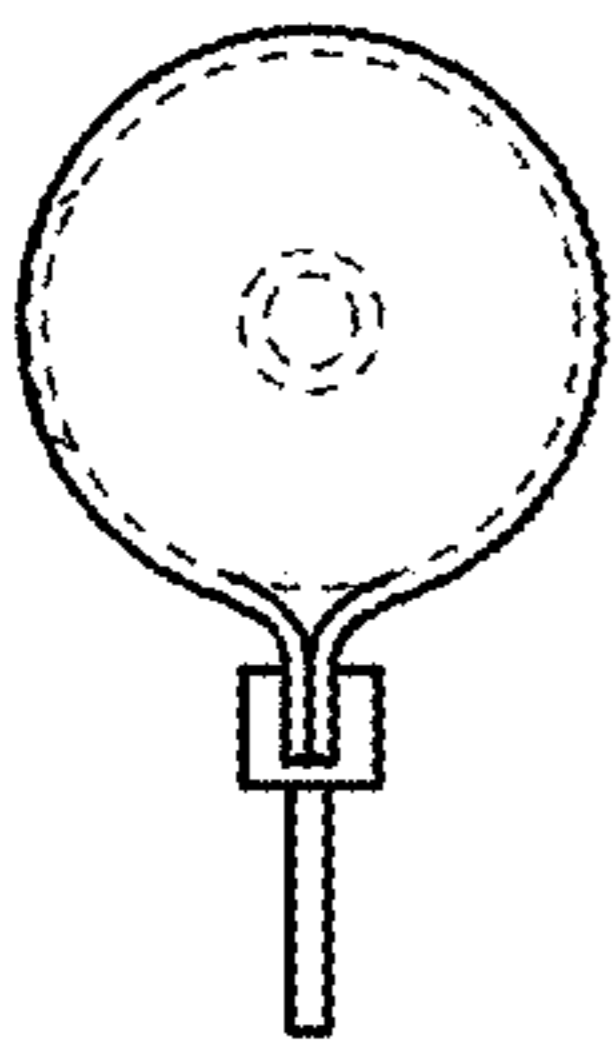

FIG. 30

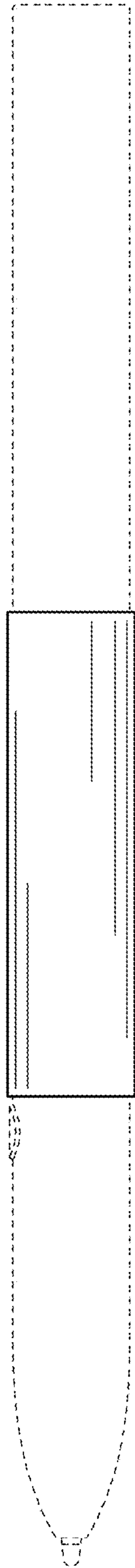

FIG. 32

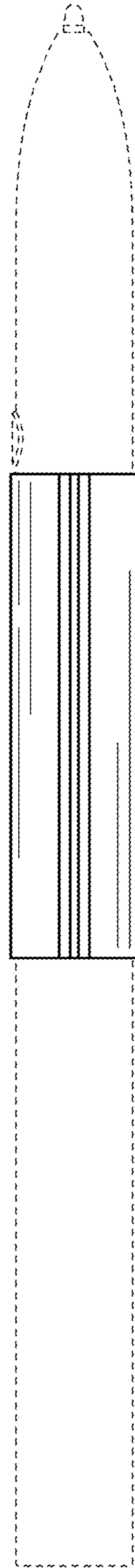

FIG. 33

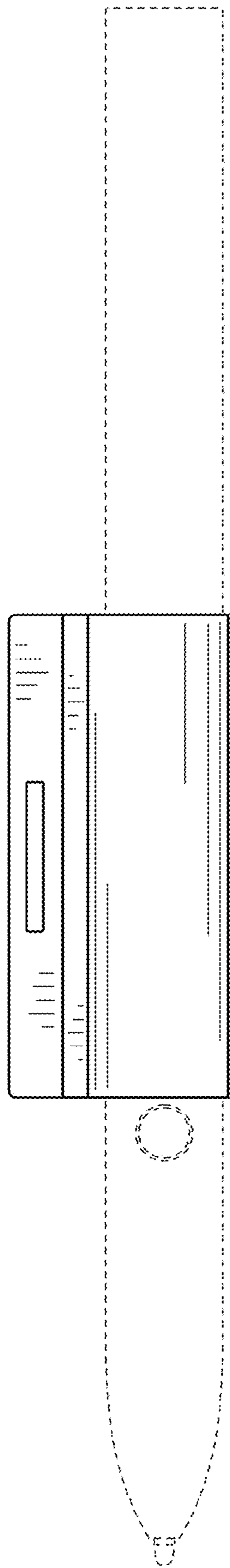

FIG. 34

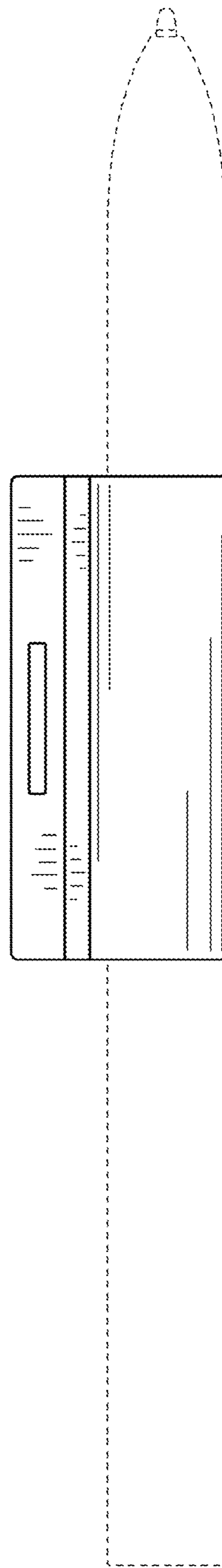

FIG. 35

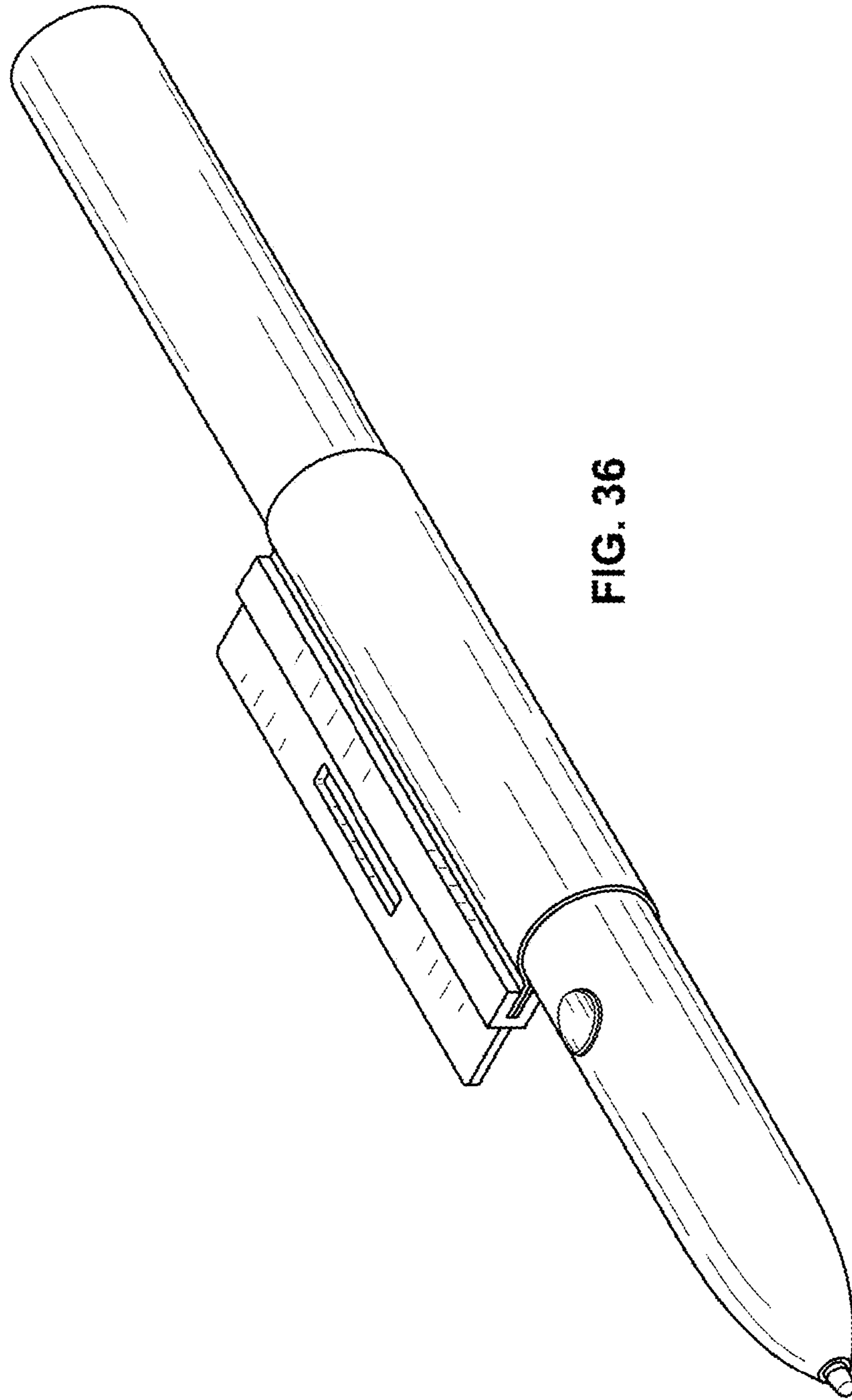

FIG. 36

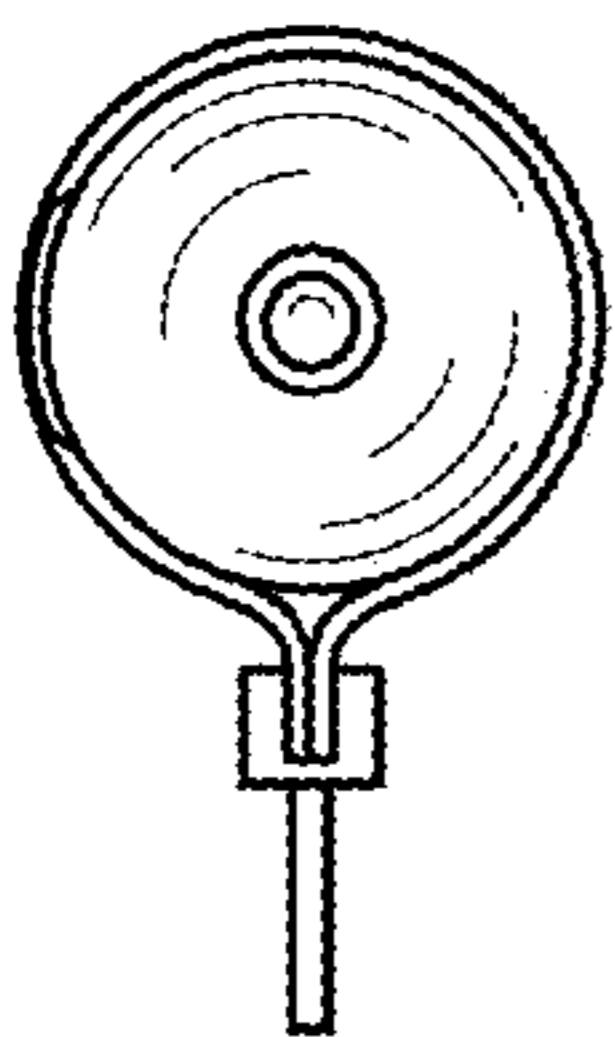

FIG. 37

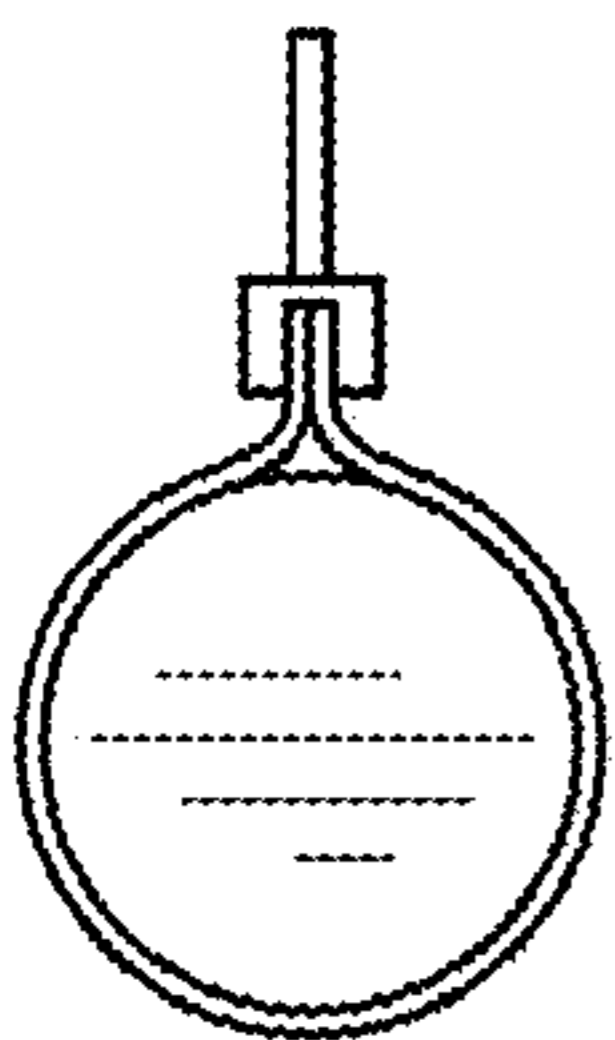

FIG. 38

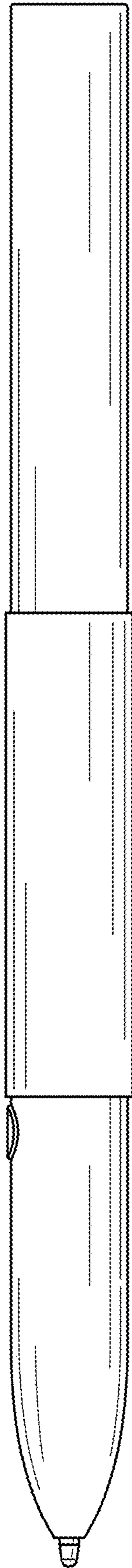

FIG. 39

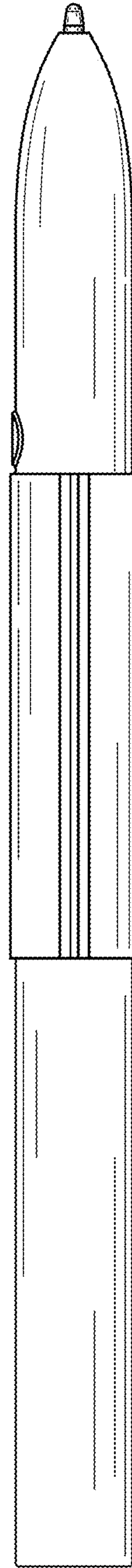

FIG. 40

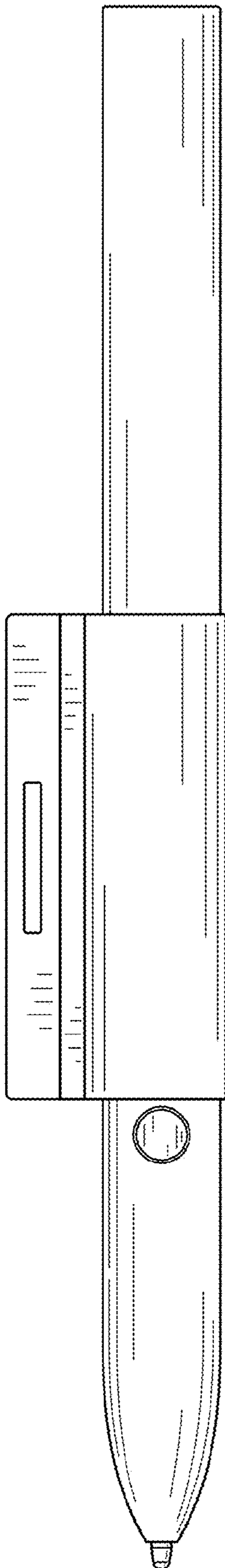

FIG. 41

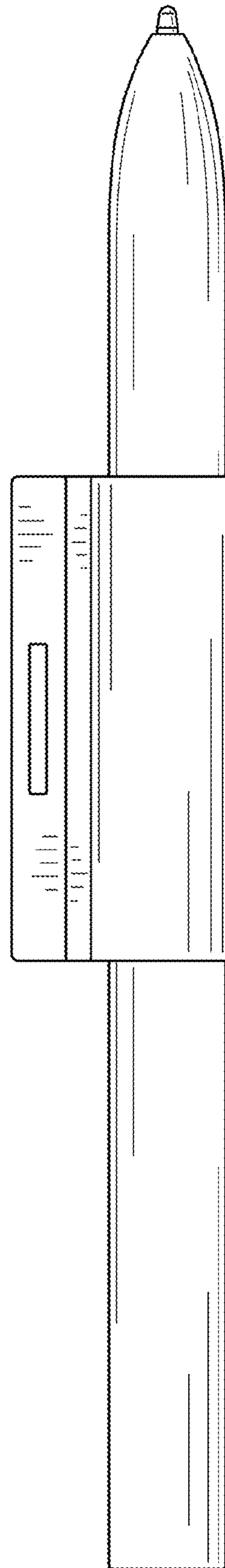

FIG. 42