



US00D897303S

(12) **United States Design Patent**
Gong et al.

(10) **Patent No.:** **US D897,303 S**
(45) **Date of Patent:** **** Sep. 29, 2020**

(54) **MOBILE PHONE**

- (71) Applicant: **Guangdong Oppo Mobile Telecommunications Corp., Ltd.**, Dongguan, Guangdong (CN)
- (72) Inventors: **Guan Gong**, Guangdong (CN); **Yuxian Lin**, Guangdong (CN); **Dongyang Xiang**, Guangdong (CN); **Jiameng Wang**, Guangdong (CN)
- (73) Assignee: **GUANGDONG OPPO MOBILE TELECOMMUNICATIONS CORP., LTD.**, Dongguan (CN)

(**) Term: **15 Years**

(21) Appl. No.: **29/687,548**

(22) Filed: **Apr. 12, 2019**

(30) **Foreign Application Priority Data**

Oct. 21, 2018 (CN) 2018 3 0587391

(51) **LOC (12) Cl.** **14-03**

(52) **U.S. Cl.**
USPC **D14/138 G; D14/138 C**

(58) **Field of Classification Search**
USPC D14/138 G, 138 AD, 138 AB, 248, 341,
D14/371, 374, 138 R, 138 AA, 138 AC,
D14/138 C, 247

(Continued)

(56) **References Cited**

U.S. PATENT DOCUMENTS

D515,536 S * 2/2006 Lee D14/138 AA
D791,729 S 7/2017 Kim et al.

(Continued)

FOREIGN PATENT DOCUMENTS

CN 304642219 S 5/2018
JP D1572861 S 3/2017
TW D174506 S 3/2016

OTHER PUBLICATIONS

Oppo Reno, announced Apr. 2019, [online], [retrieved on Jun. 26, 2020]. Retrieved from Internet ,<URL: http://www.gsmarena.com>.*

(Continued)

Primary Examiner — Bridget L Eland

(57) **CLAIM**

The ornamental design for a mobile phone, as shown and described.

DESCRIPTION

FIG. 1 is a front, right perspective view of a mobile phone showing our new design;

FIG. 2 is a rear, left perspective view of the mobile phone of FIG. 1;

FIG. 3 is a front view of the mobile phone of FIG. 1;

FIG. 4 is a rear view of the mobile phone of FIG. 1;

FIG. 5 is a left side view of the mobile phone of FIG. 1;

FIG. 6 is a right side view of the mobile phone of FIG. 1;

FIG. 7 is a top plan view of the mobile phone of FIG. 1;

FIG. 8 is a bottom plan view of the mobile phone of FIG. 1;

FIG. 9 is a front, right perspective view of the mobile phone of FIG. 1 in a closed state;

FIG. 10 is a rear, left perspective view of the mobile phone of FIG. 1 in the closed state;

FIG. 11 is a front view of the mobile phone of FIG. 1 in the closed state;

FIG. 12 is a rear view of the mobile phone of FIG. 1 in the closed state;

FIG. 13 is a left side view of the mobile phone of FIG. 1 in the closed state;

FIG. 14 is a right side view of the mobile phone of FIG. 1 in the closed state;

FIG. 15 is a top side view of the mobile phone of FIG. 1 in the closed state; and,

FIG. 16 is a bottom side view of the mobile phone of FIG. 1 in the closed state.

The broken lines are directed to environment and are for illustrative purposes only; the broken lines form no part of the claimed design.

(Continued)

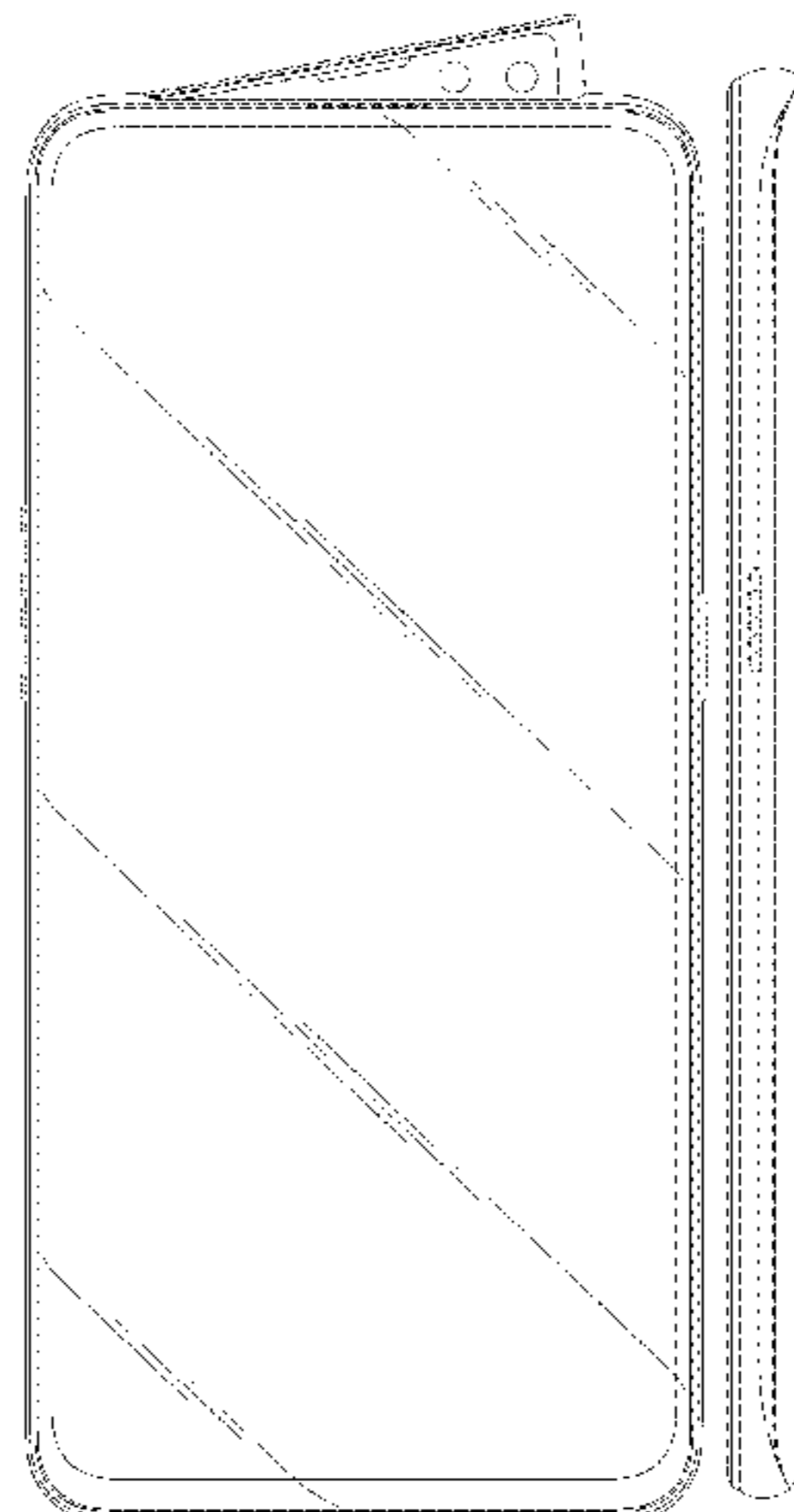

The shade lines in the figures show contour.

1 Claim, 13 Drawing Sheets

(58) Field of Classification Search

CPC H04M 1/0202; H04M 1/0235; H04M 1/0237; H04M 1/0239; H04M 1/0266; H04M 1/0268; H04M 1/027; H04M 1/0295; H04M 1/02; H04M 1/0279; H04M 1/0283

See application file for complete search history.

(56) References Cited

U.S. PATENT DOCUMENTS

D801,947	S	*	11/2017	Gordon	D14/138	G
D812,586	S	*	3/2018	Zhu	D14/138	G
D833,406	S	*	11/2018	Kim	D14/138	G
D843,962	S	*	3/2019	Kim	D14/138	G
D847,776	S	*	5/2019	Ryu	D14/138	G
D854,507	S	*	7/2019	Depape	D14/138	G
D856,293	S	*	8/2019	Seo	D14/138	G

D856,955	S	*	8/2019	Seo	D14/138	G
D863,246	S	*	10/2019	Fan	D14/138	AD
D864,142	S	*	10/2019	Fan	D14/138	AD
D866,496	S	*	11/2019	Kim	D14/138	G
D866,499	S	*	11/2019	Shin	D14/138	G
D867,314	S	*	11/2019	Mahonen	D14/138	G
D867,317	S	*	11/2019	Ha	D14/138	G
D869,423	S	*	12/2019	Cho	D14/138	G
D875,060	S	*	2/2020	Mahonen	D14/138	G
D879,733	S	*	3/2020	Fan	D14/138	AD
D879,734	S	*	3/2020	Fan	D14/138	AD
D879,735	S	*	3/2020	Fan	D14/138	AD
D881,830	S	*	4/2020	Fan	D14/138	AD
D883,944	S	*	5/2020	Matsuoka	D14/138	G
D884,689	S	*	5/2020	Chen	D14/248	
D886,755	S	*	6/2020	Park	D14/138	G
D886,758	S	*	6/2020	Wang	D14/138	C
2020/0084307	A1	*	3/2020	Gong	H04M 1/0208	

OTHER PUBLICATIONS

Oppo Reno 2, announced Aug. 28, 2019, [online], [retrieved on Jun. 26, 2020]. Retrieved from Internet ,<URL: <http://www.gsmarena.com>>.*

* cited by examiner

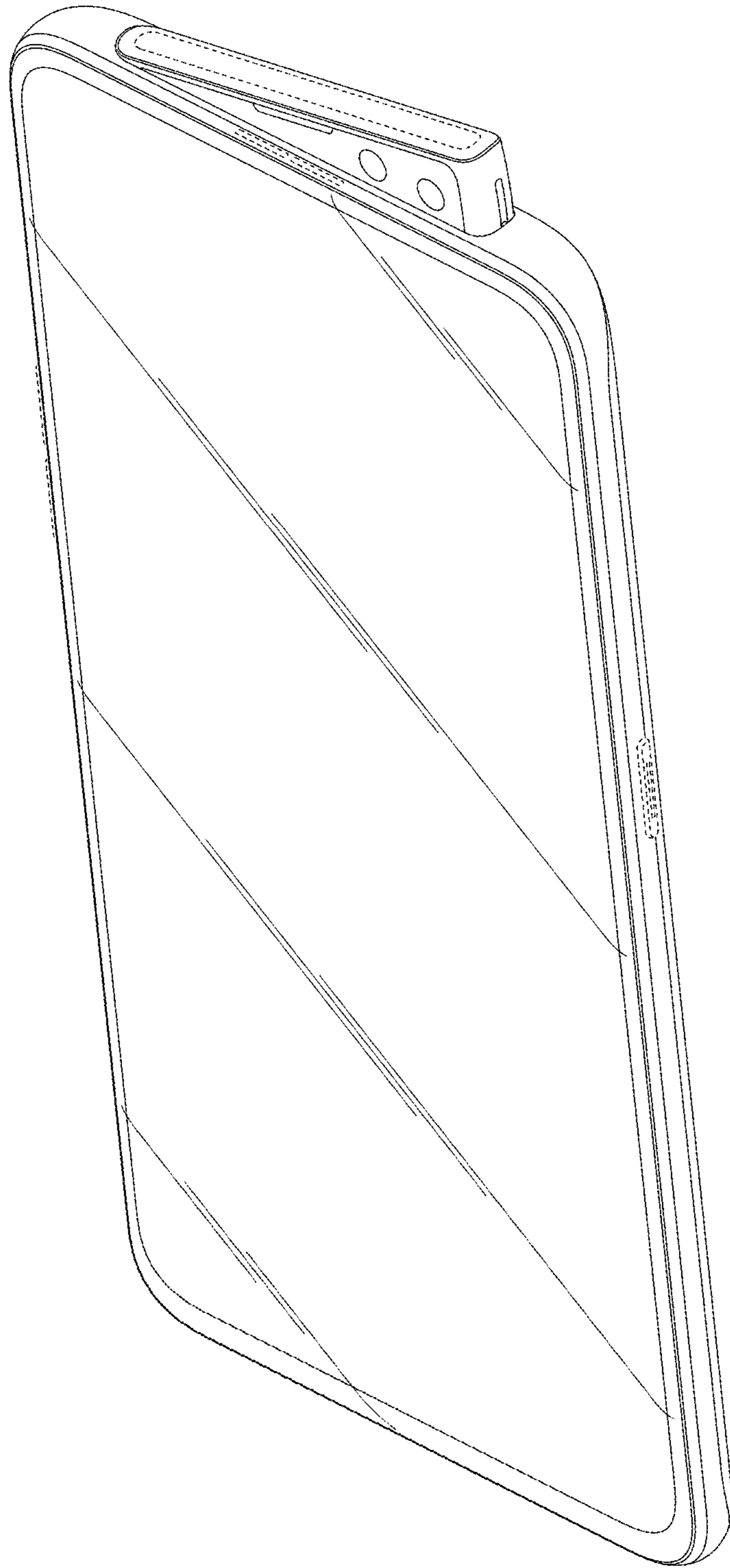

FIG. 1

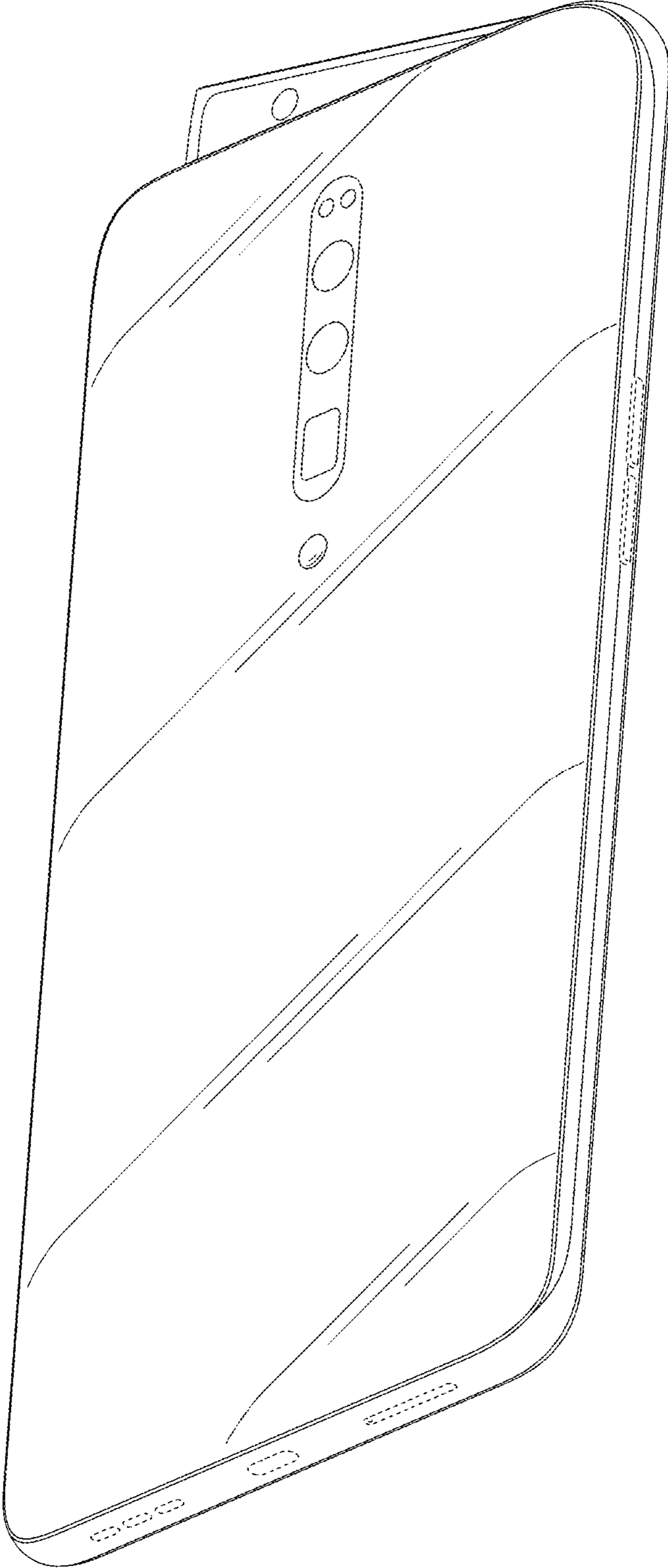

FIG. 2

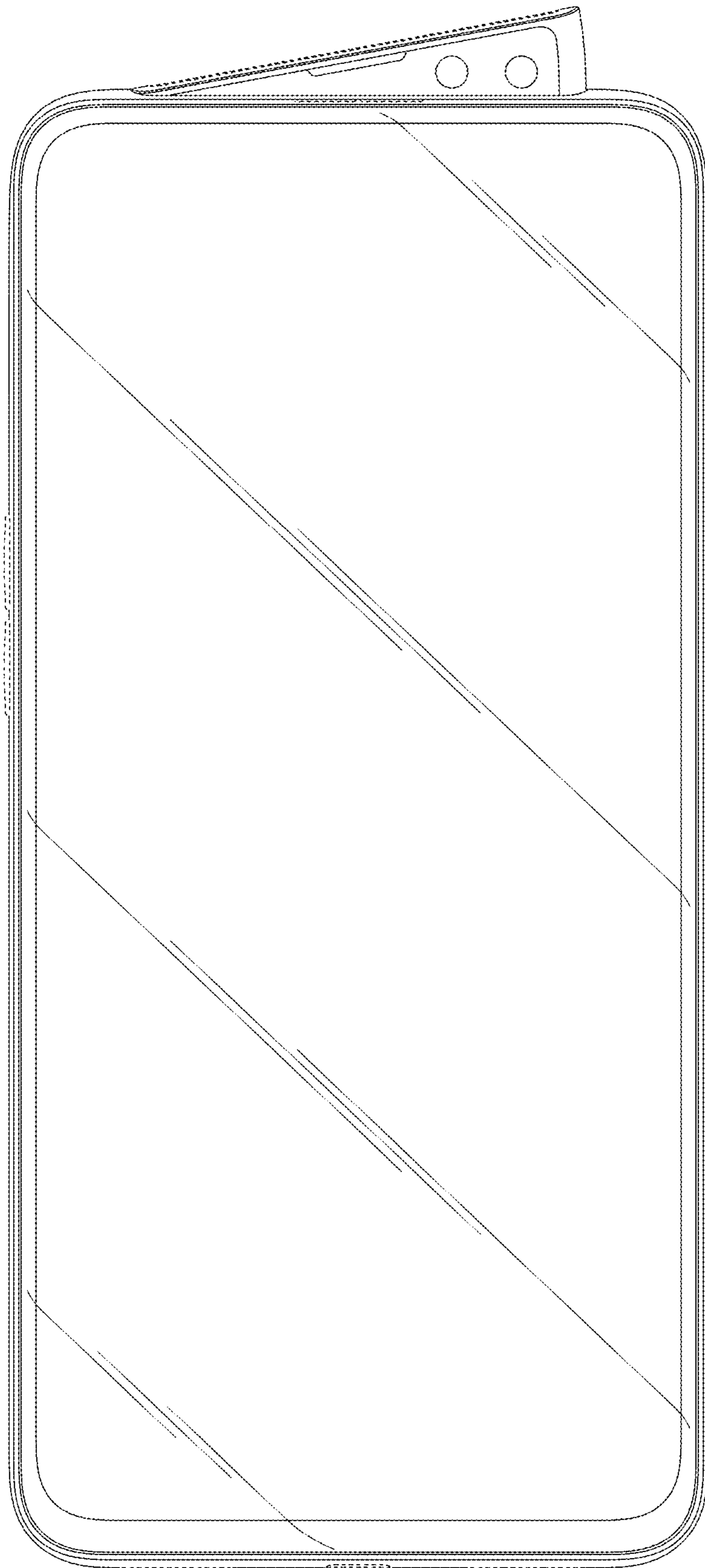

FIG. 3

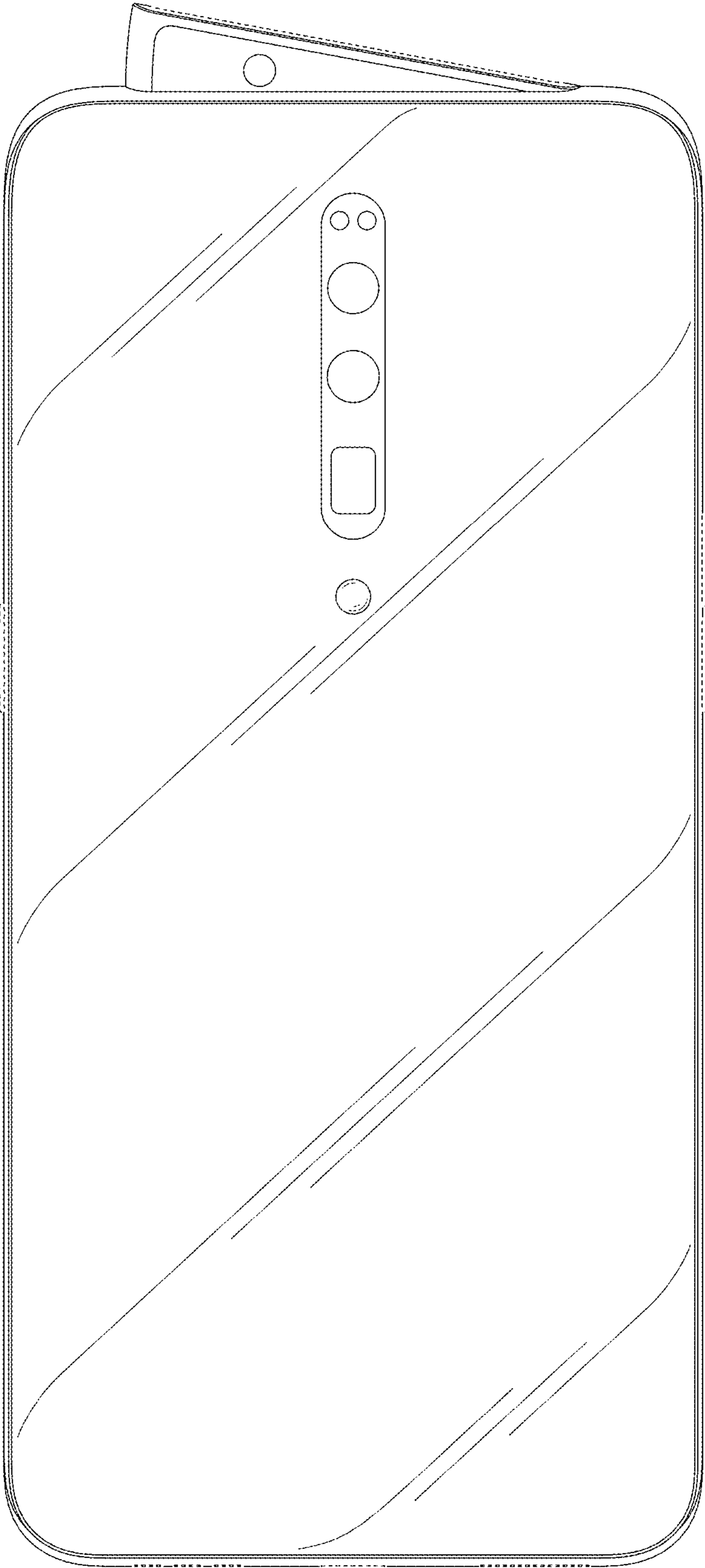

FIG. 4

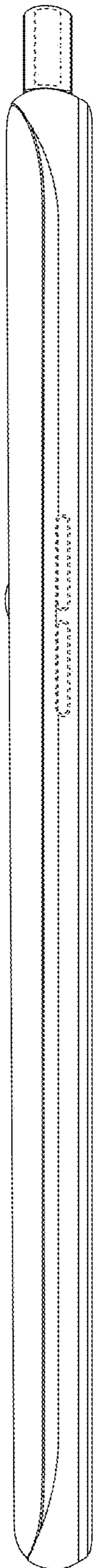

FIG. 5

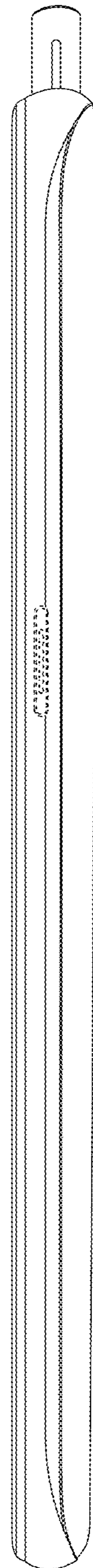

FIG. 6

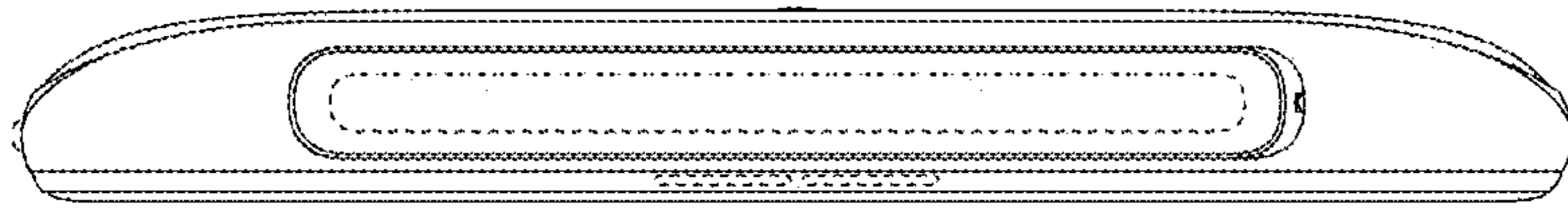

FIG. 7

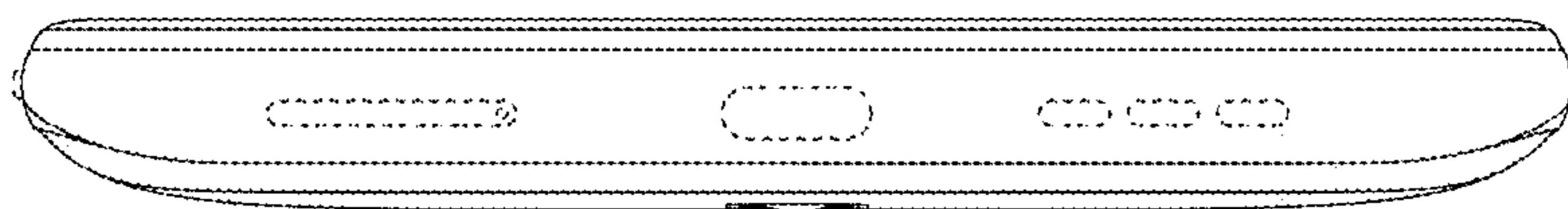

FIG. 8

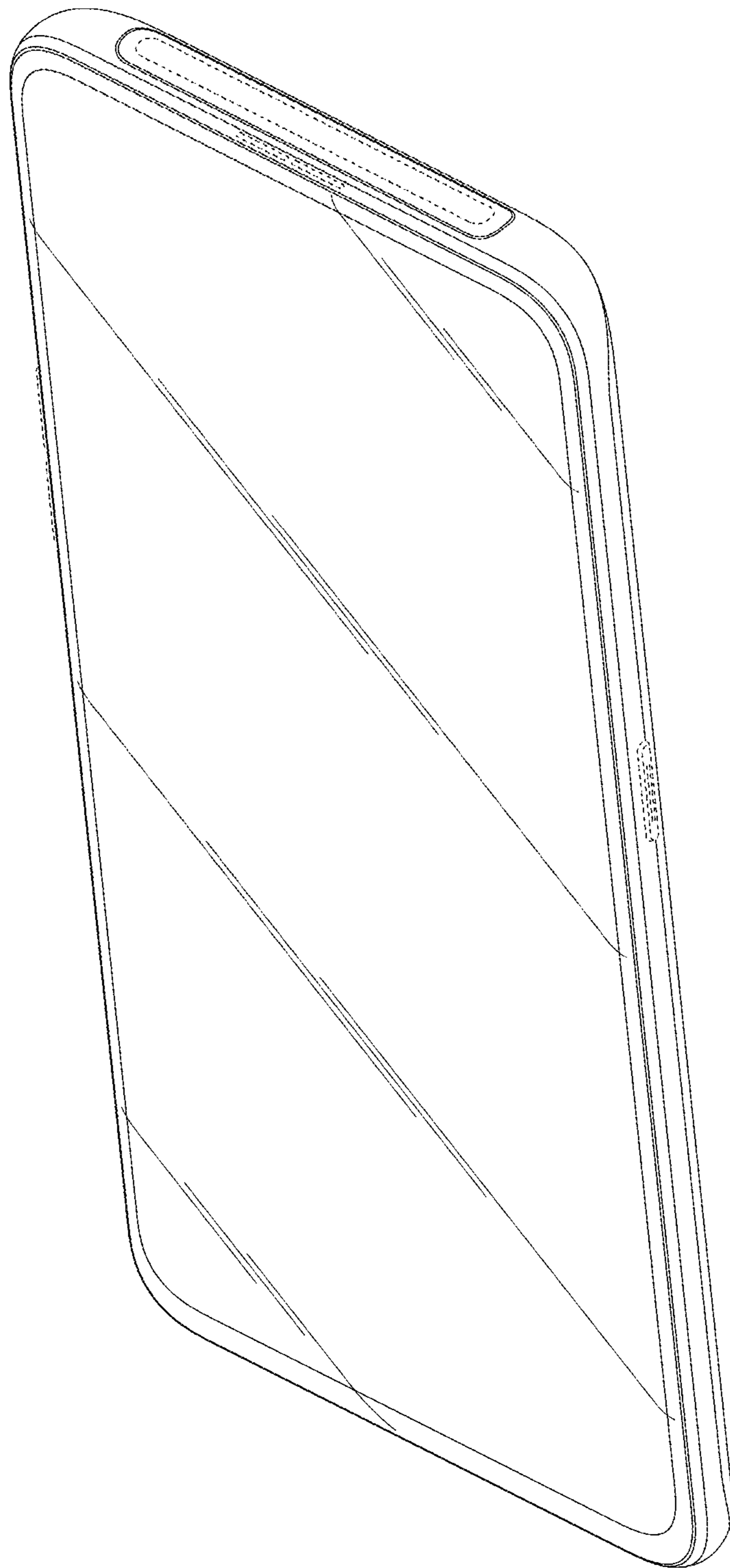

FIG. 9

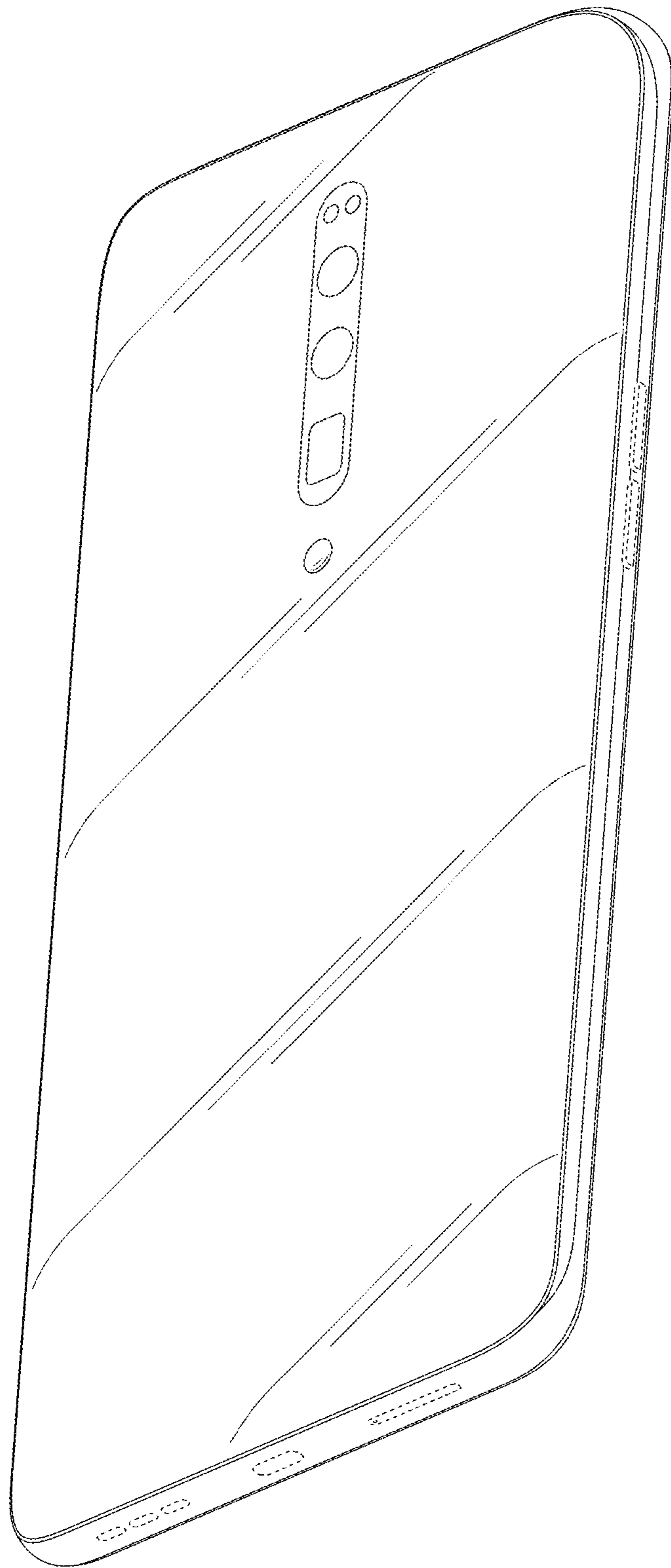

FIG. 10

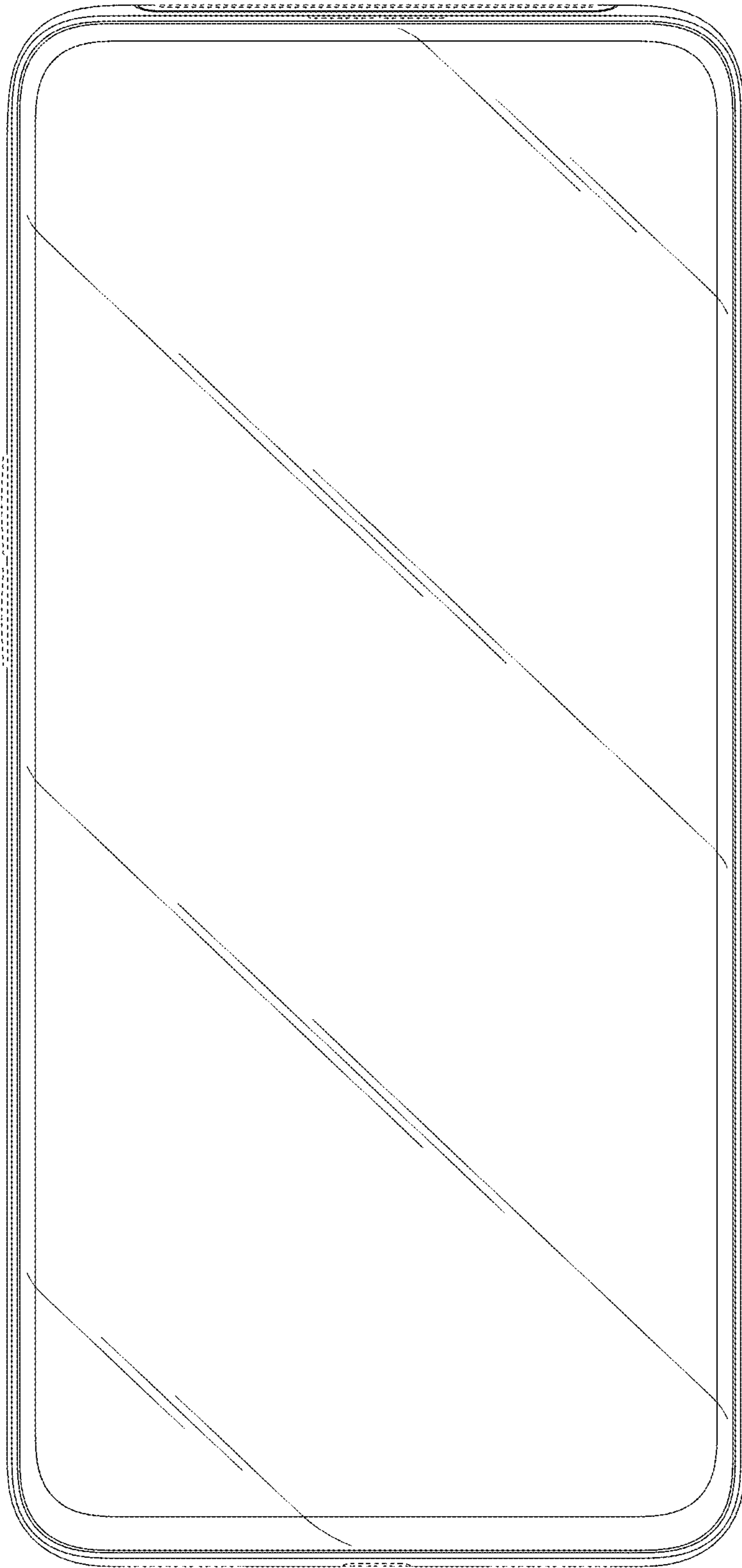

FIG. 11

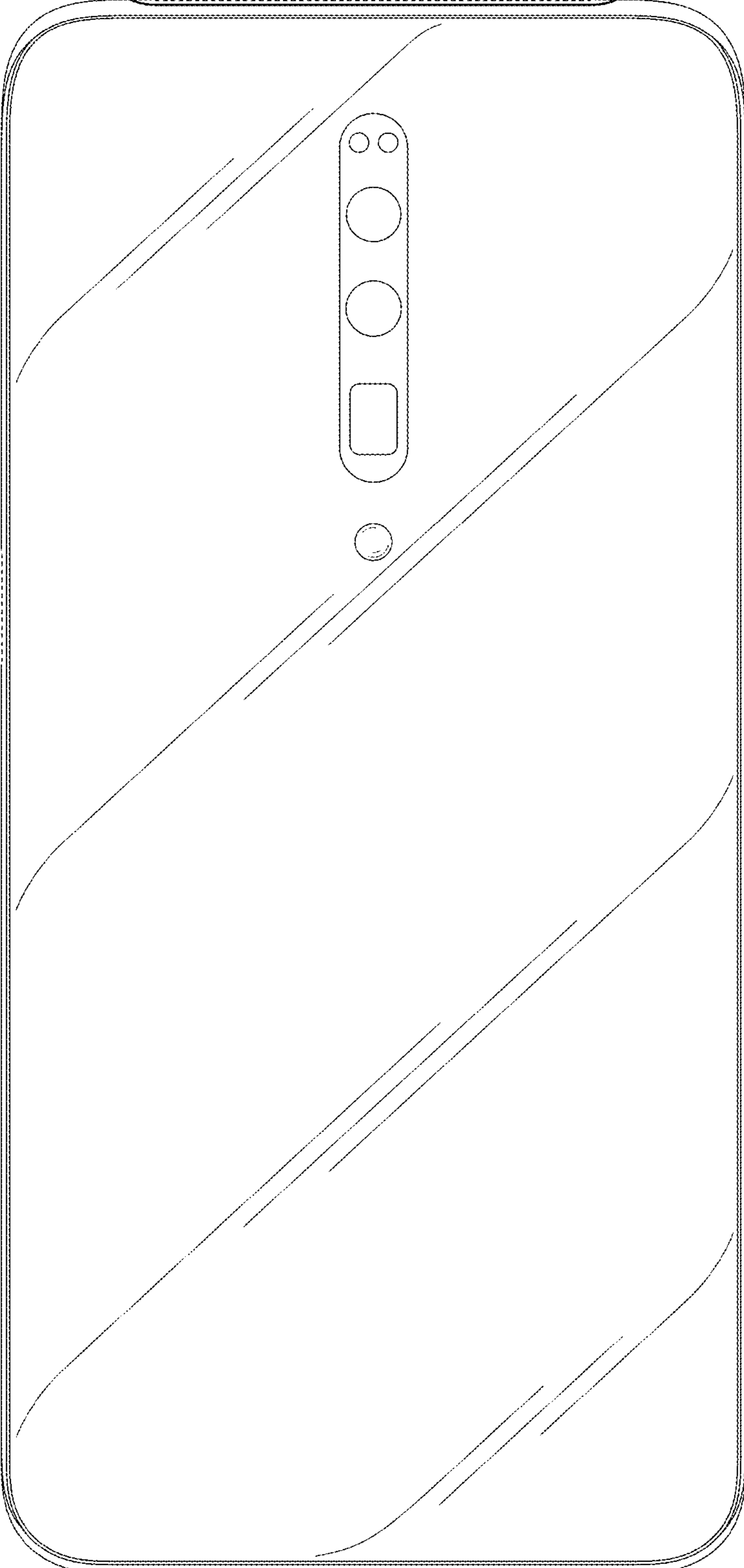

FIG. 12

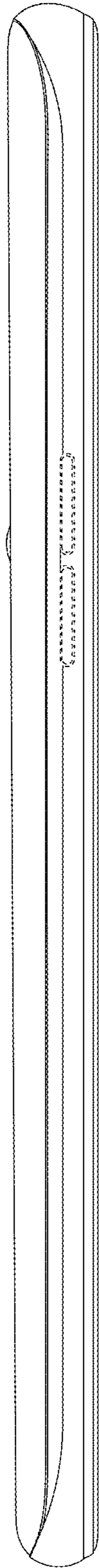

FIG. 13

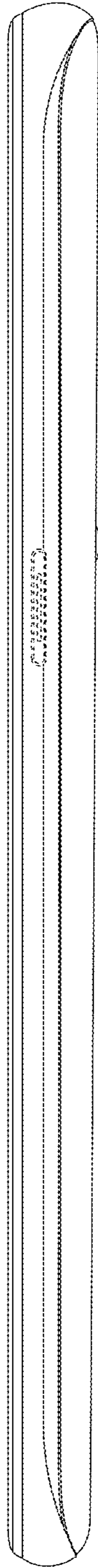

FIG. 14

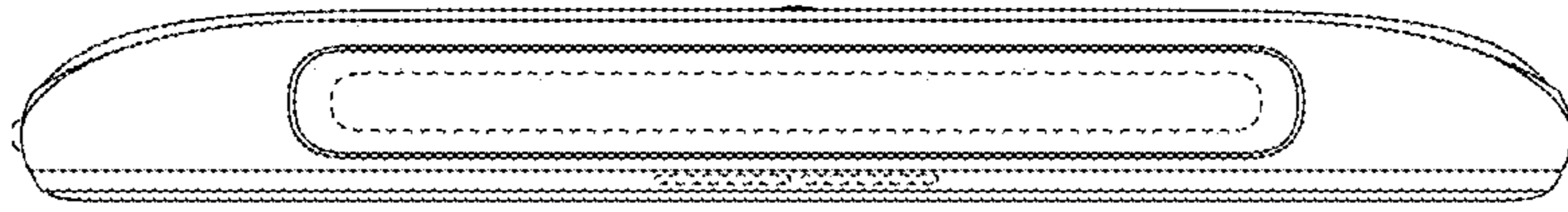

FIG. 15



FIG. 16