



US00D897240S

(12) **United States Design Patent** (10) **Patent No.:** **US D897,240 S**
Al Attar (45) **Date of Patent:** **** Sep. 29, 2020**

(54) **VEHICLE, TOY, AND/OR REPLICAS THEREOF**

(71) Applicant: **Bayerische Motoren Werke Aktiengesellschaft, Munich (DE)**

(72) Inventor: **Hussein Al Attar, Munich (DE)**

(73) Assignee: **Bayerische Motoren Werke Aktiengesellschaft, Munich (DE)**

(**) Term: **15 Years**

(21) Appl. No.: **29/694,267**

(22) Filed: **Jun. 10, 2019**

(30) **Foreign Application Priority Data**

Dec. 17, 2018 (DE) 40 2018 101 274

(51) **LOC (12) Cl.** **12-08**

(52) **U.S. Cl.**
USPC **D12/91**

(58) **Field of Classification Search**
USPC D12/86, 90-92; D21/424, 433, 434;
296/181.1-181.5, 183.1

CPC B62D 25/00; B62D 25/06; B62D 33/00;
B62D 35/00

See application file for complete search history.

(56) **References Cited**

U.S. PATENT DOCUMENTS

D582,314 S	12/2008	Leclercq	
D716,189 S	10/2014	Nordmann	
D742,283 S	11/2015	Forsgren	
D743,846 S *	11/2015	Guille	D12/92
D759,543 S	6/2016	Nissl	
D803,100 S *	11/2017	Forschner	D12/92
D813,727 S *	3/2018	Beermann	D12/92
D825,390 S *	8/2018	Al Attar	D12/92
D831,541 S *	10/2018	Buckingham	D12/92
D832,147 S *	10/2018	Ojea	D12/92
D834,453 S *	11/2018	Buckingham	D12/92

(Continued)

FOREIGN PATENT DOCUMENTS

EM 000831623-0001 4/2009

Primary Examiner — Melody N Brown

(74) *Attorney, Agent, or Firm* — Crowell & Moring LLP

(57) **CLAIM**

The ornamental design for a vehicle, toy, and/or replicas thereof, as shown and described.

DESCRIPTION

This application contains subject matter related to the following co-pending U.S. design patent applications: application Ser. No. 29/694,268, filed herewith and entitled "RADIATOR GRILLE FOR A VEHICLE"; application Ser. No. 29/694,270, filed herewith and entitled "FRONT BUMPER FOR A VEHICLE"; application Ser. No. 29/694,271, filed herewith and entitled "FRONT FENDER FOR A VEHICLE"; application Ser. No. 29/694,272, filed herewith and entitled "REAR FENDER FOR A VEHICLE"; application Ser. No. 29/694,273, filed herewith and entitled "REAR BUMPER FOR A VEHICLE"; application Ser. No. 29/694,274, filed herewith and entitled "TAILGATE FOR A VEHICLE"; application Ser. No. 29/694,277, filed herewith and entitled "TAILLIGHT FOR A VEHICLE"; and application Ser. No. 29/694,278, filed herewith and entitled "TAILLIGHT FOR A VEHICLE".

FIG. 1 is a left, front perspective view of a vehicle, toy, and/or replicas thereof according to the design; FIG. 2 is a left side view thereof; FIG. 3 is a right side view thereof; FIG. 4 is a right, rear perspective view thereof; FIG. 5 is a front view thereof; FIG. 6 is a rear view thereof; and, FIG. 7 is a top view thereof.

1 Claim, 7 Drawing Sheets



(56)

References Cited

U.S. PATENT DOCUMENTS

D834,454 S	*	11/2018	Luk	D12/92
D835,007 S		12/2018	Schneider	
D844,490 S	*	4/2019	Luk	D12/92
D845,834 S	*	4/2019	Sarremejean	D12/91
D860,052 S	*	9/2019	Kezha	D12/92
D860,053 S	*	9/2019	Forschner	D12/92
D860,054 S	*	9/2019	Kezha	D12/92
D871,266 S	*	12/2019	Ojea	D12/92
D881,758 S	*	4/2020	Kezha	D12/92

* cited by examiner

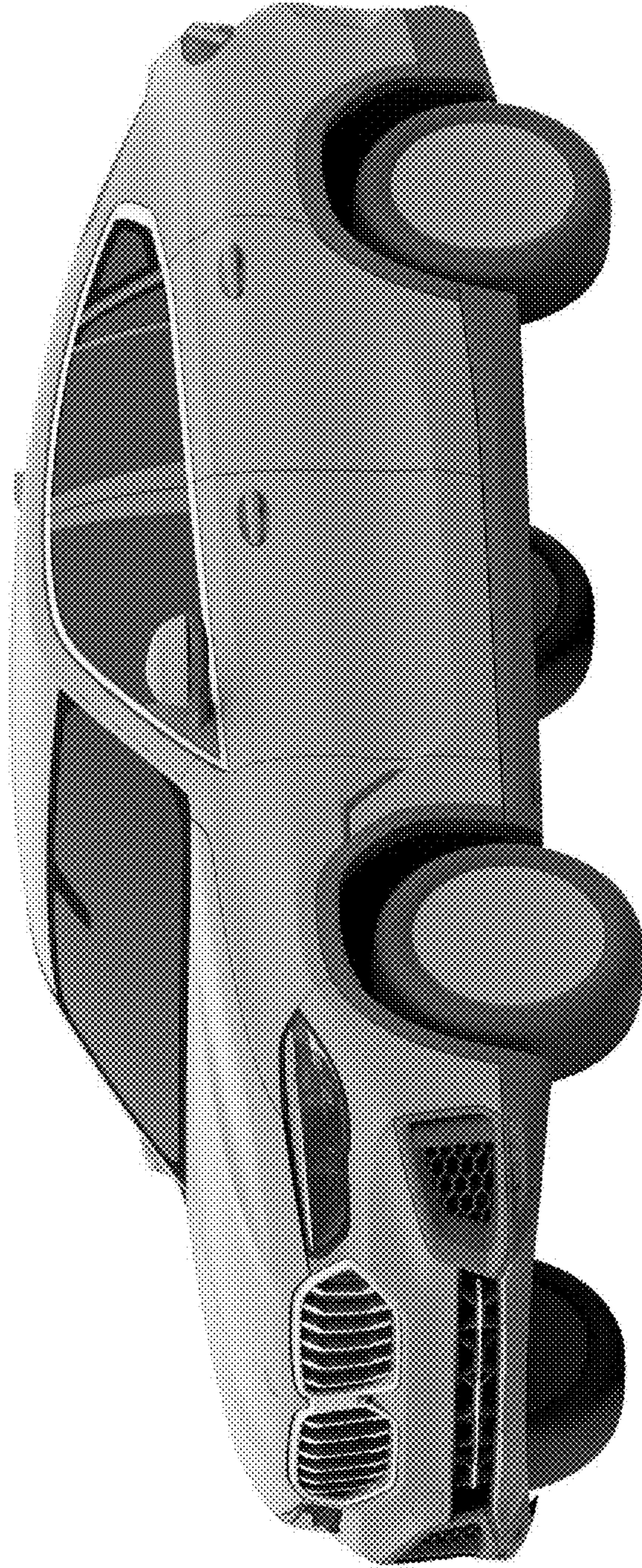

Fig. 1

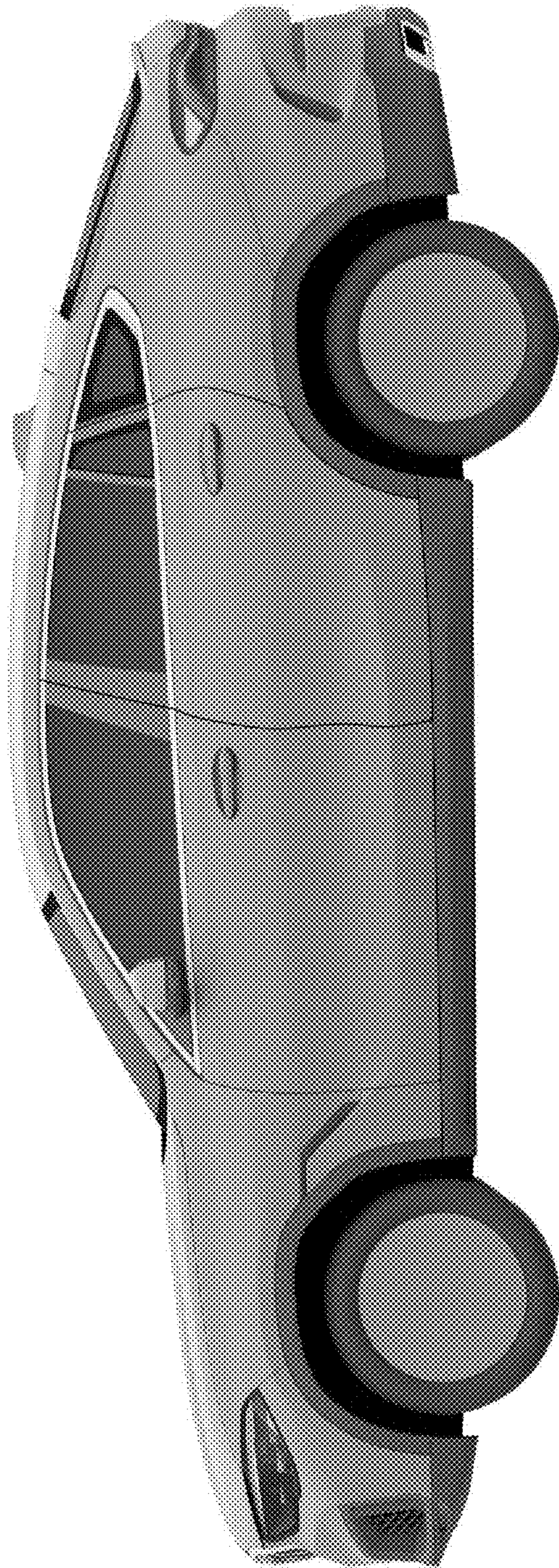

Fig. 2

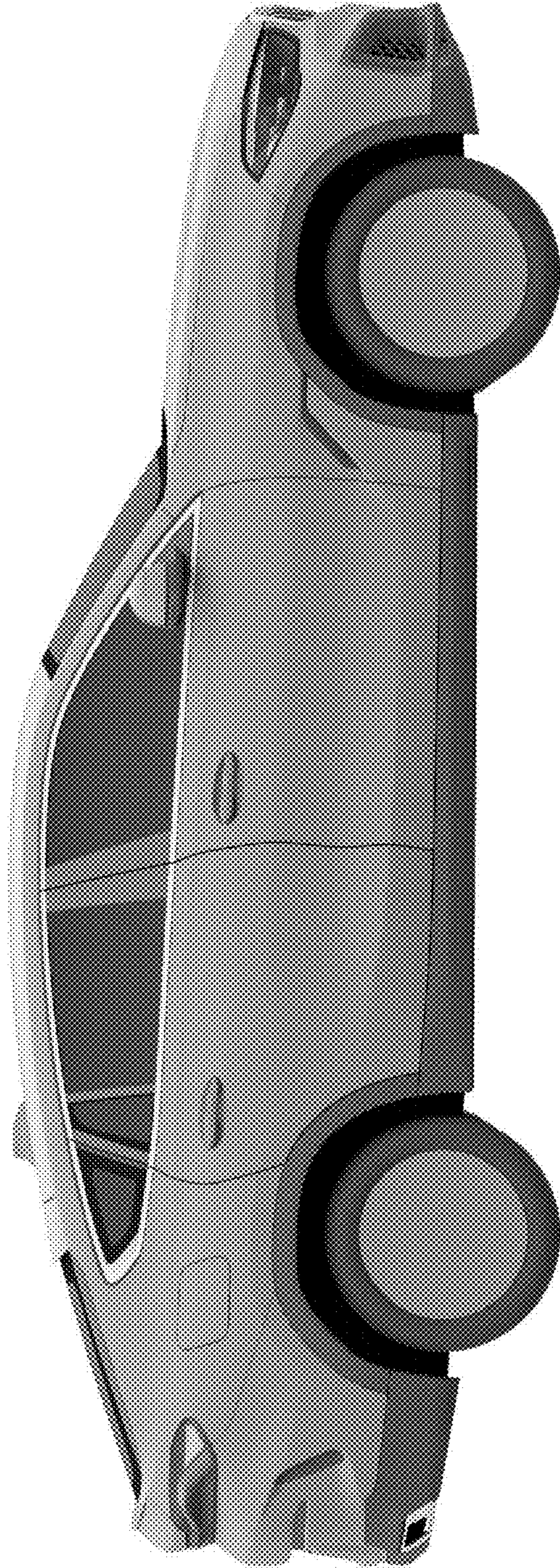

Fig. 3

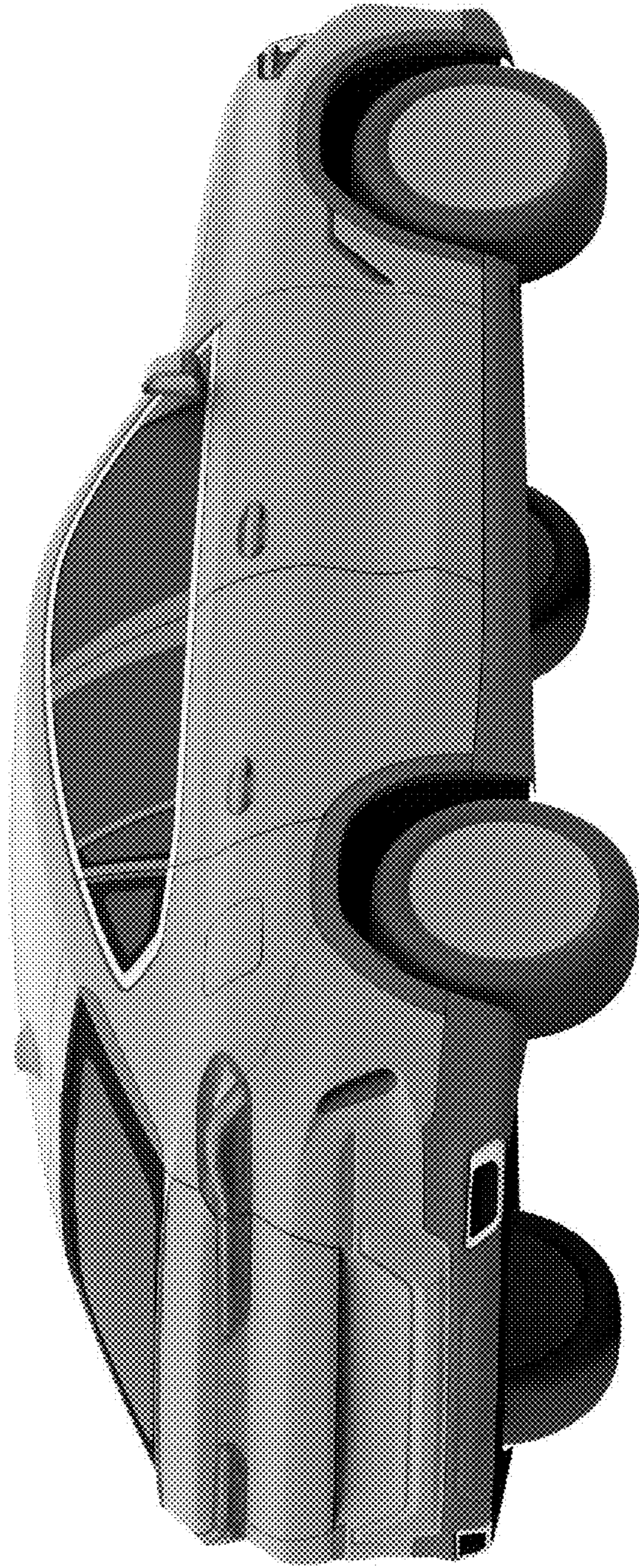

Fig. 4

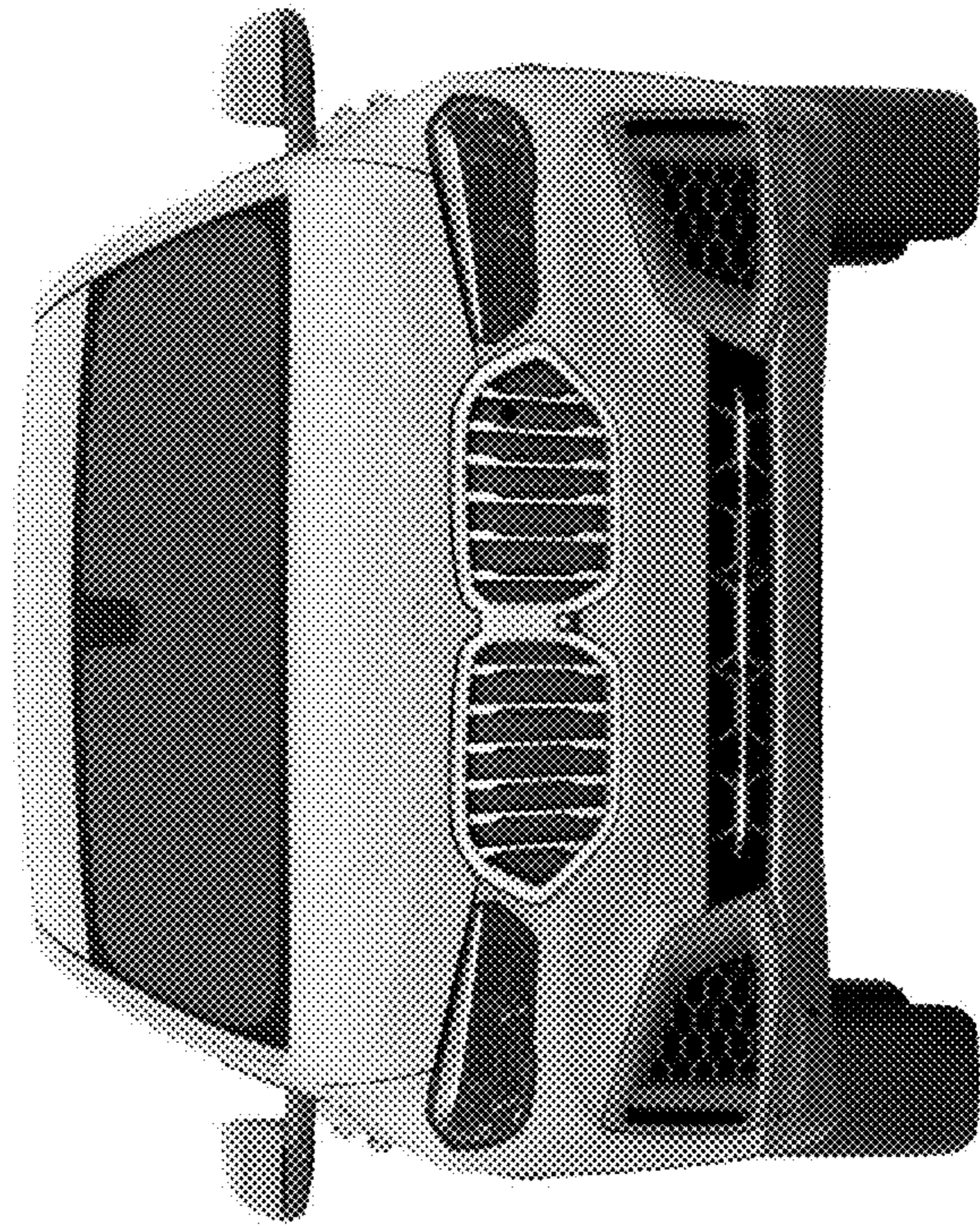

Fig. 5

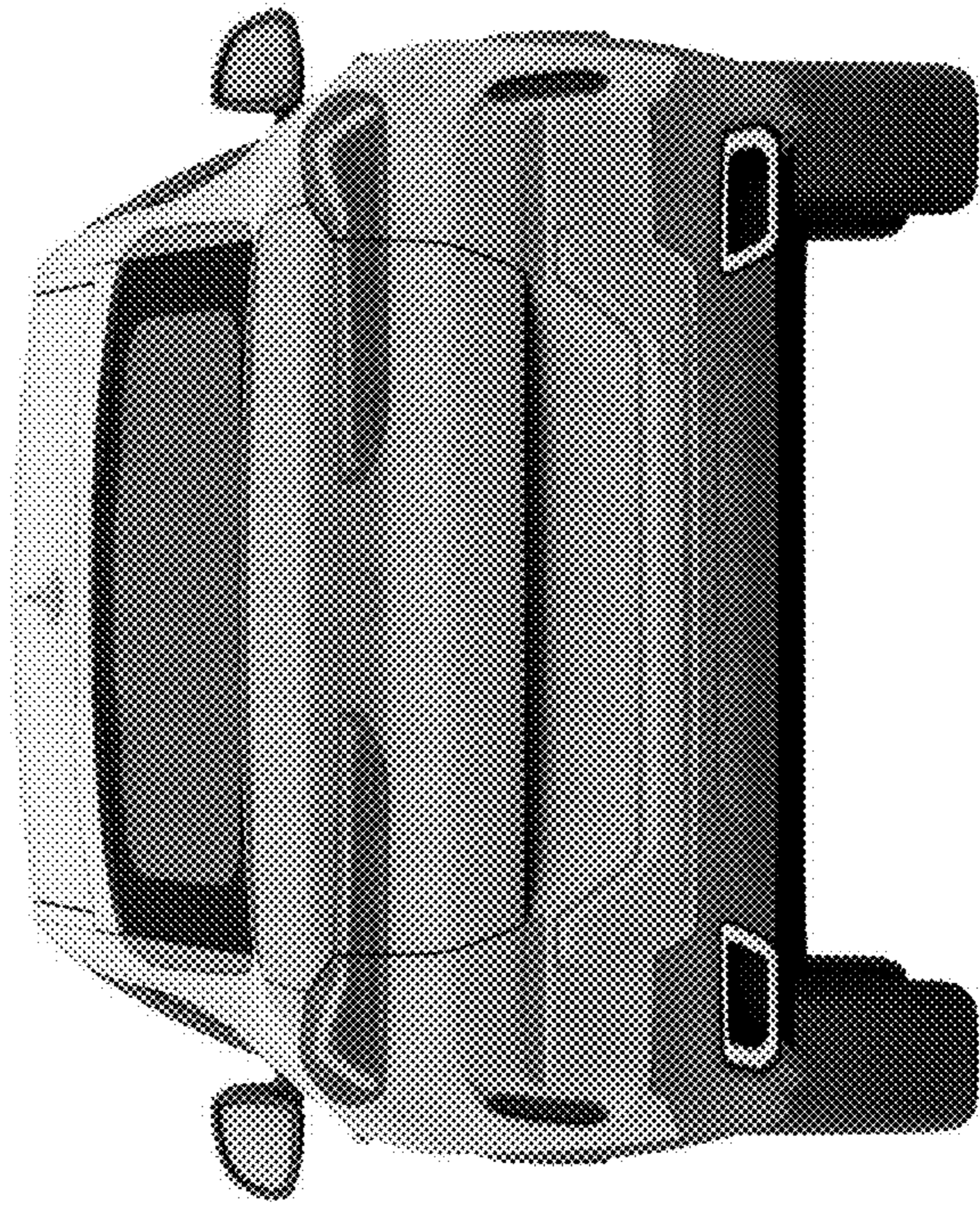

Fig. 6

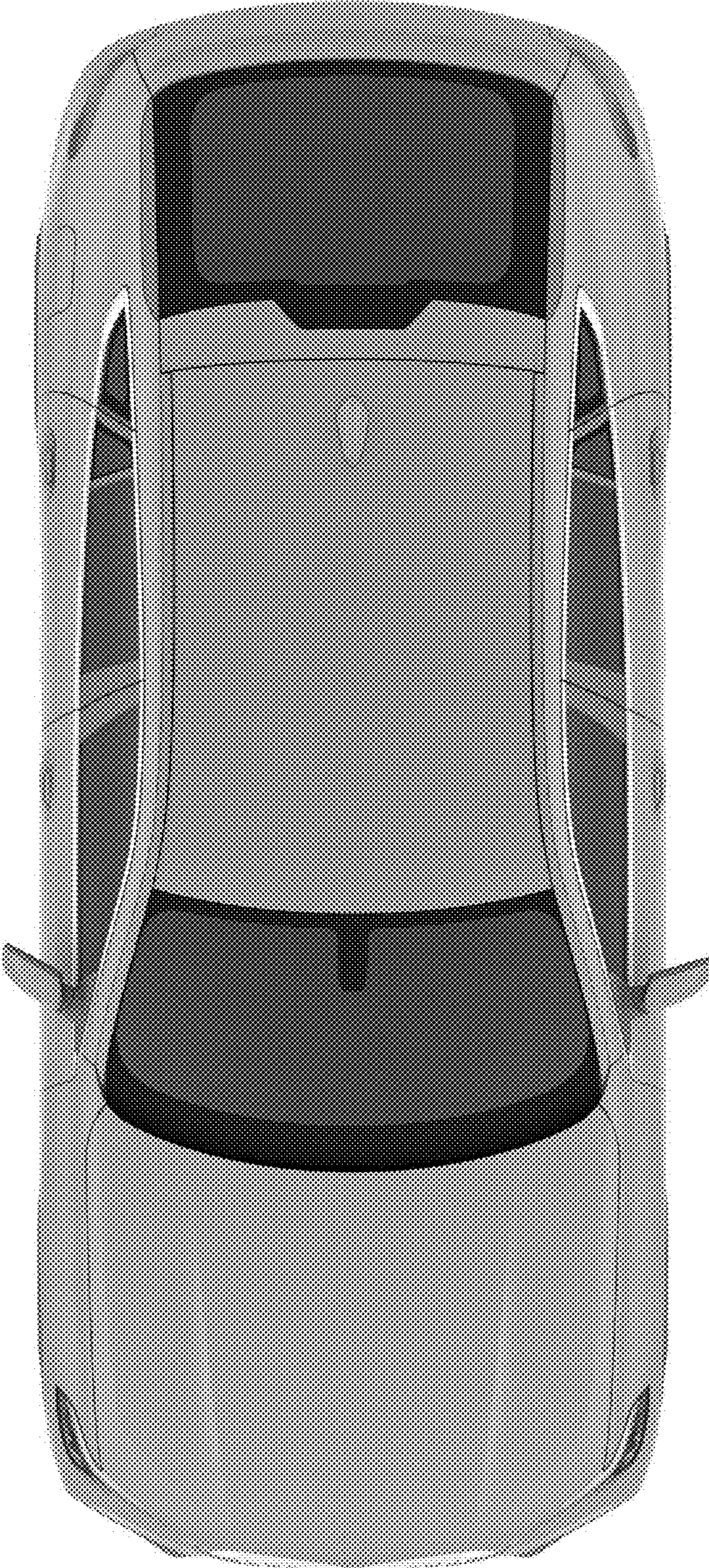

Fig. 7