



US00D897182S

(12) **United States Design Patent** (10) **Patent No.:** **US D897,182 S**
Marfione et al. (45) **Date of Patent:** **** Sep. 29, 2020**

- (54) **BLADE**
- (71) Applicants: **Anthony Louis Marfione**, Fletcher, NC (US); **Sean Christopher Marfione**, Fletcher, NC (US)
- (72) Inventors: **Anthony Louis Marfione**, Fletcher, NC (US); **Sean Christopher Marfione**, Fletcher, NC (US)
- (73) Assignee: **Microtech Knives, Inc.**, Bradford, PA (US)
- (**) Term: **15 Years**
- (21) Appl. No.: **29/703,060**
- (22) Filed: **Aug. 23, 2019**
- (51) **LOC (12) Cl.** **08-03**
- (52) **U.S. Cl.**
USPC **D8/99**; D8/20
- (58) **Field of Classification Search**
USPC D8/20, 70, 95-101; D7/649, 650; D15/17, 139; D22/117, 118
CPC B23D 49/006; B23D 49/10; B23D 49/11; B23D 49/14; B23D 61/121; B23D 61/123; B23D 61/126; B23D 61/128; B26B 1/02; B26B 1/048; B26B 3/08; A61B 17/3213
See application file for complete search history.

- (56) **References Cited**
U.S. PATENT DOCUMENTS
832,455 A * 10/1906 Christensen B44D 3/162 7/105
1,408,368 A * 2/1922 Lewis A47J 43/288 30/353

D133,417 S *	8/1942	Sau	D8/98
D150,488 S *	8/1948	Amstutz	D8/98
D300,600 S *	4/1989	High	D8/107
D379,293 S *	5/1997	Schultz	D8/98
D388,572 S *	12/1997	Gold	D32/46
D390,304 S *	2/1998	Thompson	D22/118
D391,821 S *	3/1998	Schultz	D8/98
D426,132 S	6/2000	Pardue		
D438,442 S	3/2001	Osborne		
D454,768 S	3/2002	Onion		
D508,838 S *	8/2005	Meizlish	D8/98
D514,419 S *	2/2006	Henriksen	D8/98
8,893,389 B2	11/2014	Freeman		
D776,227 S *	1/2017	Pelton	D22/118
D813,623 S	3/2018	Marfione		
D841,426 S *	2/2019	Goldstein	D8/99
D861,754 S *	10/2019	Fukuyama	D15/139
D867,098 S *	11/2019	Patterson	D8/98
D870,532 S *	12/2019	Marfione	D8/99
D880,270 S *	4/2020	Sung	D8/99
2013/0188337 A1	7/2013	Staines		

* cited by examiner

Primary Examiner — Elizabeth A. Albert
(74) *Attorney, Agent, or Firm* — Steve LeBlanc, LLC

(57) **CLAIM**

The ornamental design for a blade, as shown and described.

DESCRIPTION

FIG. 1 is a front perspective view of the blade;
FIG. 2 is a right side view of the blade;
FIG. 3 is a left side view of the blade;
FIG. 4 is a top view of the blade;
FIG. 5 is a bottom view of the blade;
FIG. 6 is a front view of the blade; and,
FIG. 7 is a rear view of the blade.

1 Claim, 6 Drawing Sheets

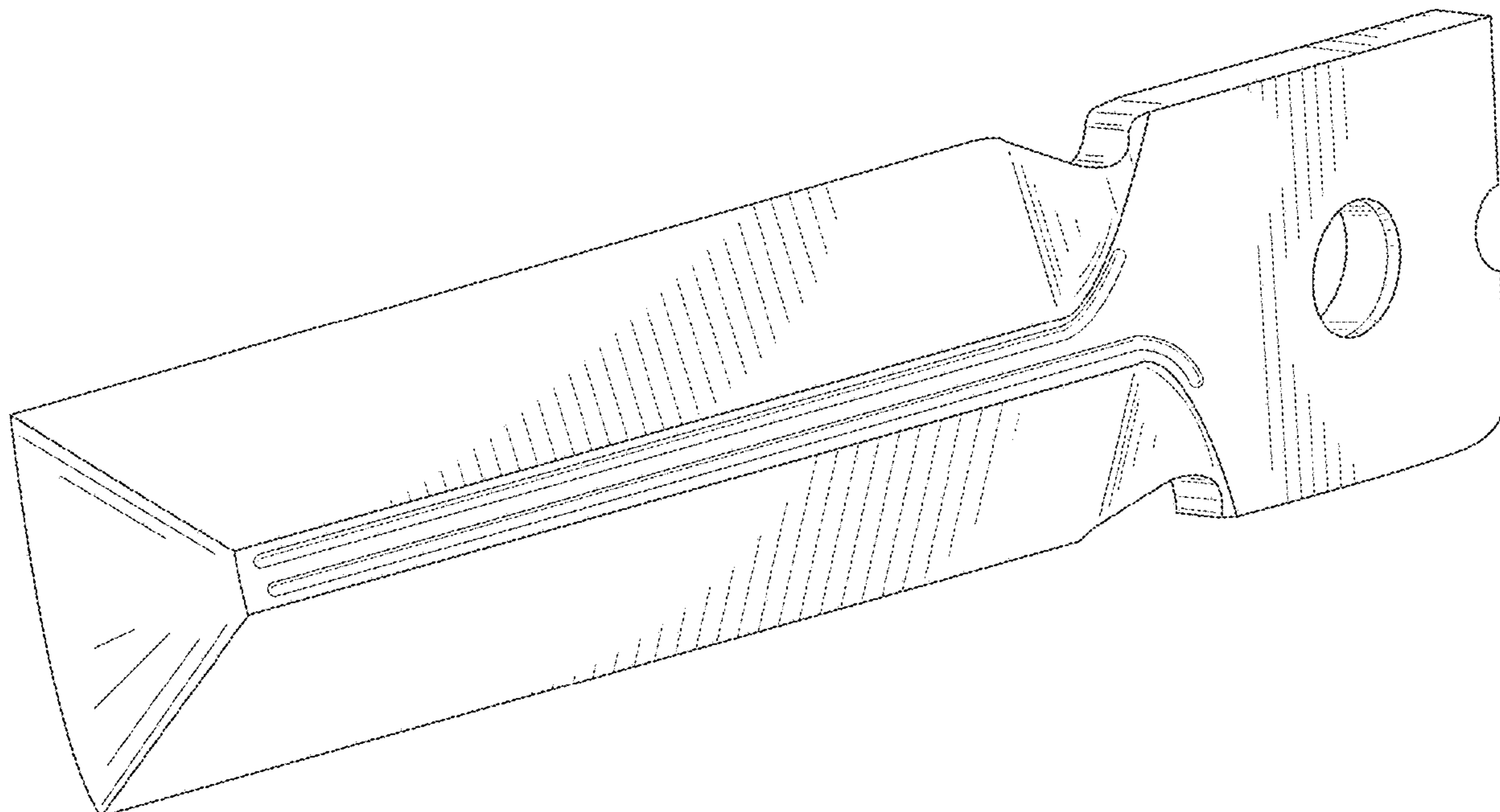

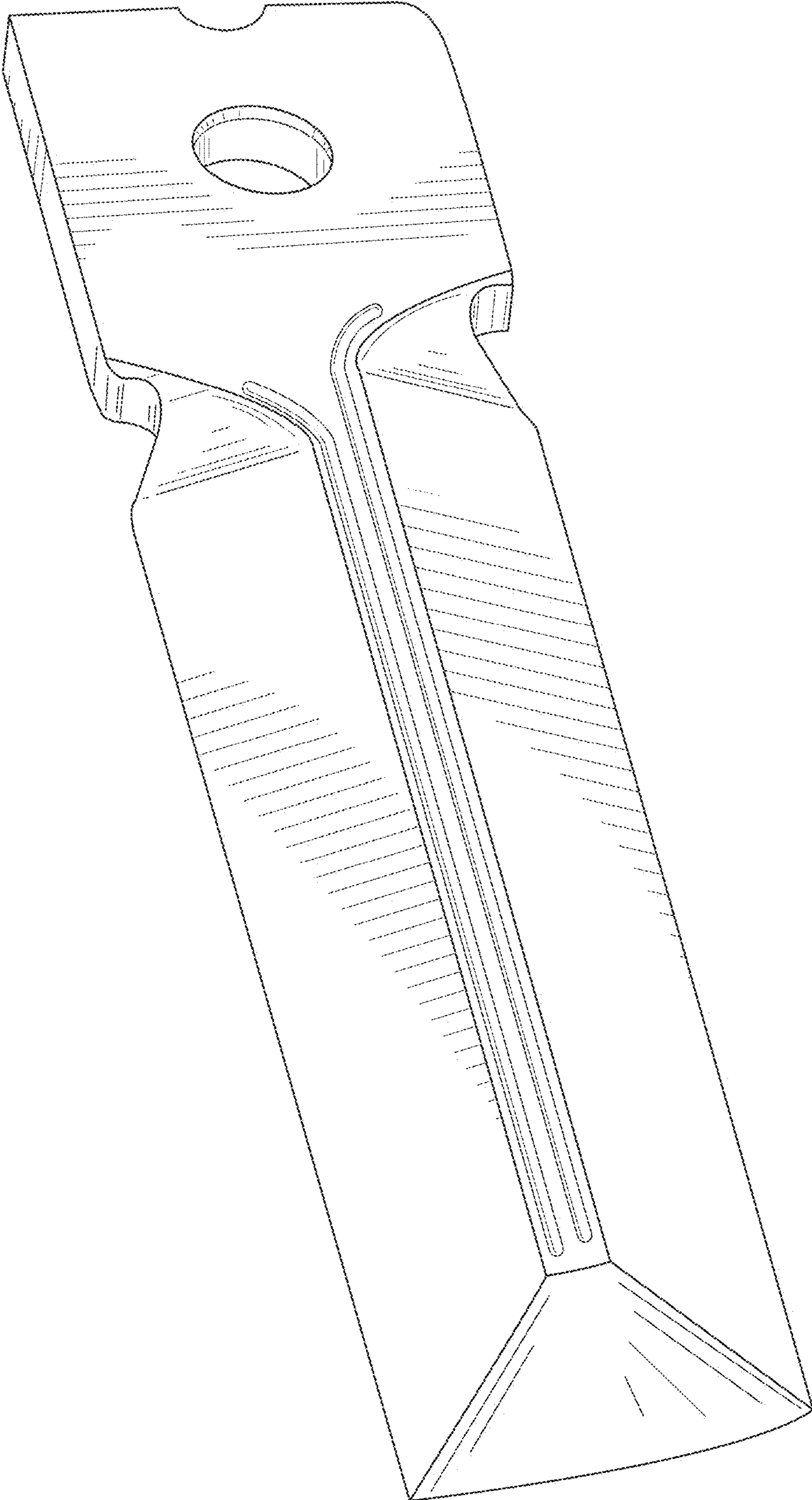

FIG. 1

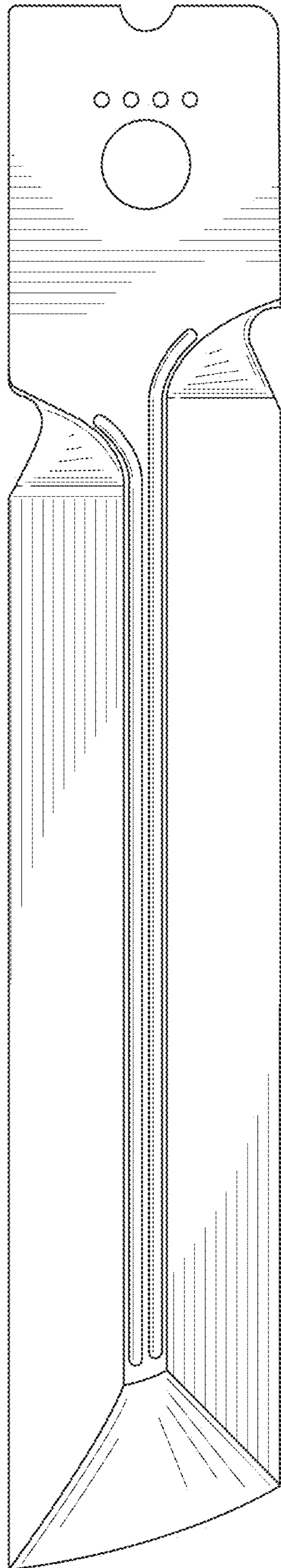

FIG. 2

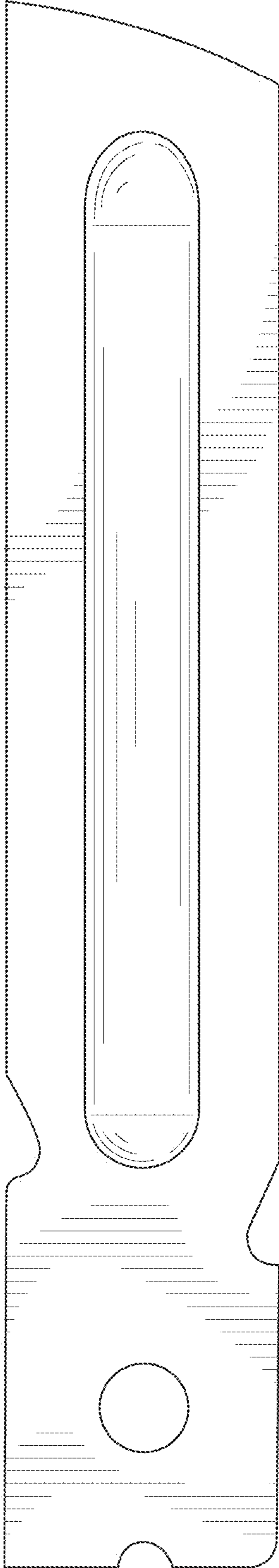

FIG. 3

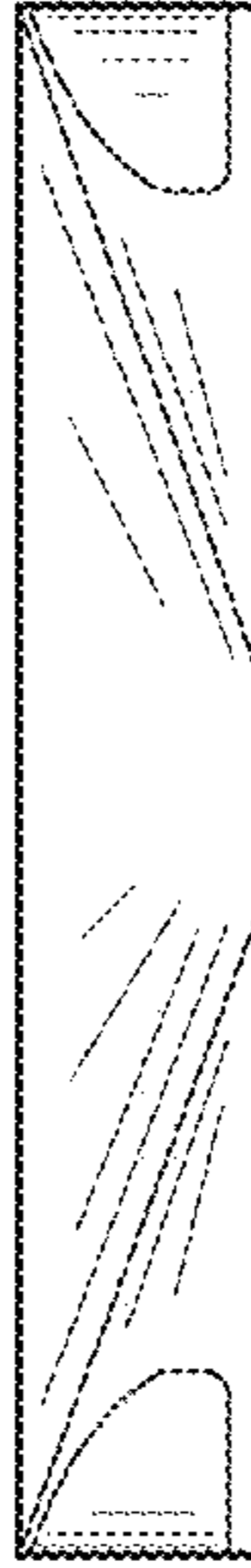

FIG. 4



FIG. 5

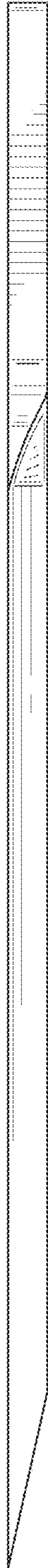

FIG. 6

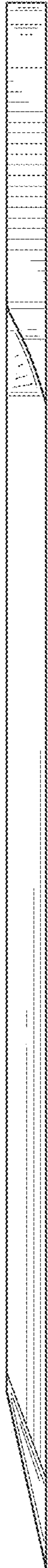

FIG. 7