

US00D897164S

(12) **United States Design Patent**
Veldkamp

(10) **Patent No.:** **US D897,164 S**

(45) **Date of Patent:** **** Sep. 29, 2020**

(54) **KITCHEN TOOL**

OTHER PUBLICATIONS

(71) Applicant: **Spectrum Diversified Designs, LLC**,
Streetsboro, OH (US)

Zyliss Avocado Tool, Amazon.com website page, <https://www.amazon.com/Zyliss-12550-ZYLISS-Avocado-Tool/dp/B00421ATN6>, dated Apr. 4, 2019, 1 page.

(72) Inventor: **Derek Veldkamp**, Seattle, WA (US)

OXO Good Grips 3-In-1 Avocado Slicer, Amazon.com website page, https://www.amazon.com/OXO-Good-Grips-Avocado-Slicer/dp/B0088LR592/ref=pd_lpo_vtph_79_bs_img_1?encoding=UTF8&psc=1&refRID=8G0Y4T0K08WPN6G7PRGF, dated Apr. 4, 2019, 1 page.

(73) Assignee: **SPECTRUM DIVERSIFIED DESIGNS, LLC**, Streetsboro, OH (US)

(**) Term: **15 Years**

* cited by examiner

(21) Appl. No.: **29/688,932**

Primary Examiner — Terry A Wallace

(22) Filed: **Apr. 25, 2019**

(74) *Attorney, Agent, or Firm* — Tucker Ellis LLP

(51) **LOC (12) Cl.** **07-06**

(52) **U.S. Cl.**
USPC **D7/693**

(57) **CLAIM**

(58) **Field of Classification Search**
USPC D7/680–696, 368, 669, 412
CPC ... B26D 3/24; B26D 3/26; B26D 3/02; B26D
3/06; A47J 17/02; A47J 17/00; A47J
17/04; A47J 9/005

The ornamental design for a kitchen tool, as shown and described.

See application file for complete search history.

DESCRIPTION

(56) **References Cited**

FIG. 1 is a top perspective view of a kitchen tool showing our new design.

U.S. PATENT DOCUMENTS

FIG. 2 is a rear view thereof.

5,613,431 A *	3/1997	Tateno	A47J 17/02
				30/114
D515,884 S *	2/2006	Holcomb	D7/673
7,421,786 B2 *	9/2008	Dorion	A47J 17/02
				30/114
D611,314 S *	3/2010	Eide	D7/694
D631,712 S *	2/2011	Hull	D7/693
D681,405 S *	5/2013	Bagley	D7/693

FIG. 3 is a front view thereof.

FIG. 4 is a left side view thereof.

FIG. 5 is a right side view thereof.

FIG. 6 is a top view thereof.

FIG. 7 is a bottom view thereof; and,

FIG. 8 is a bottom perspective view thereof.

1 Claim, 8 Drawing Sheets

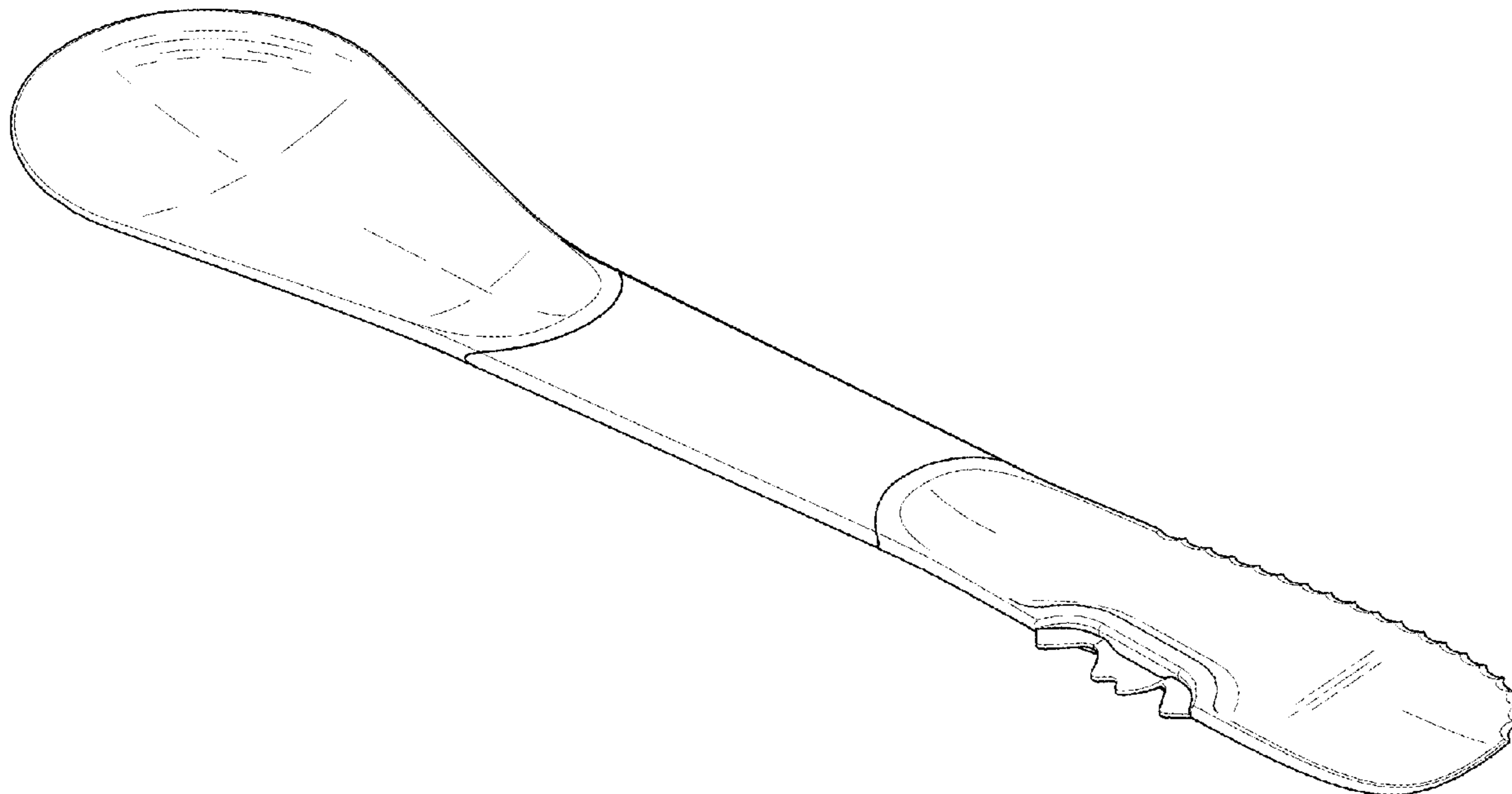

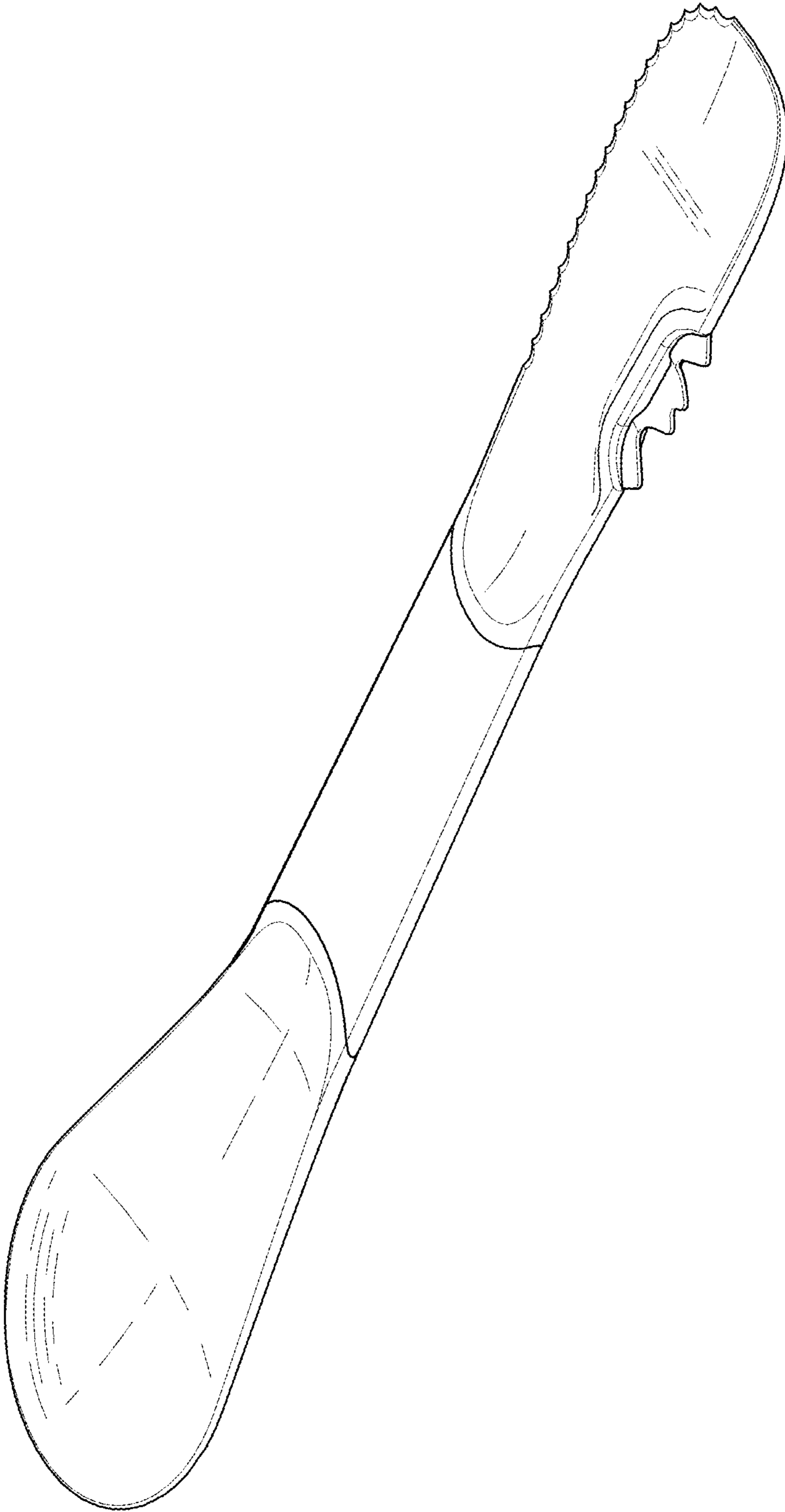

Fig. 1

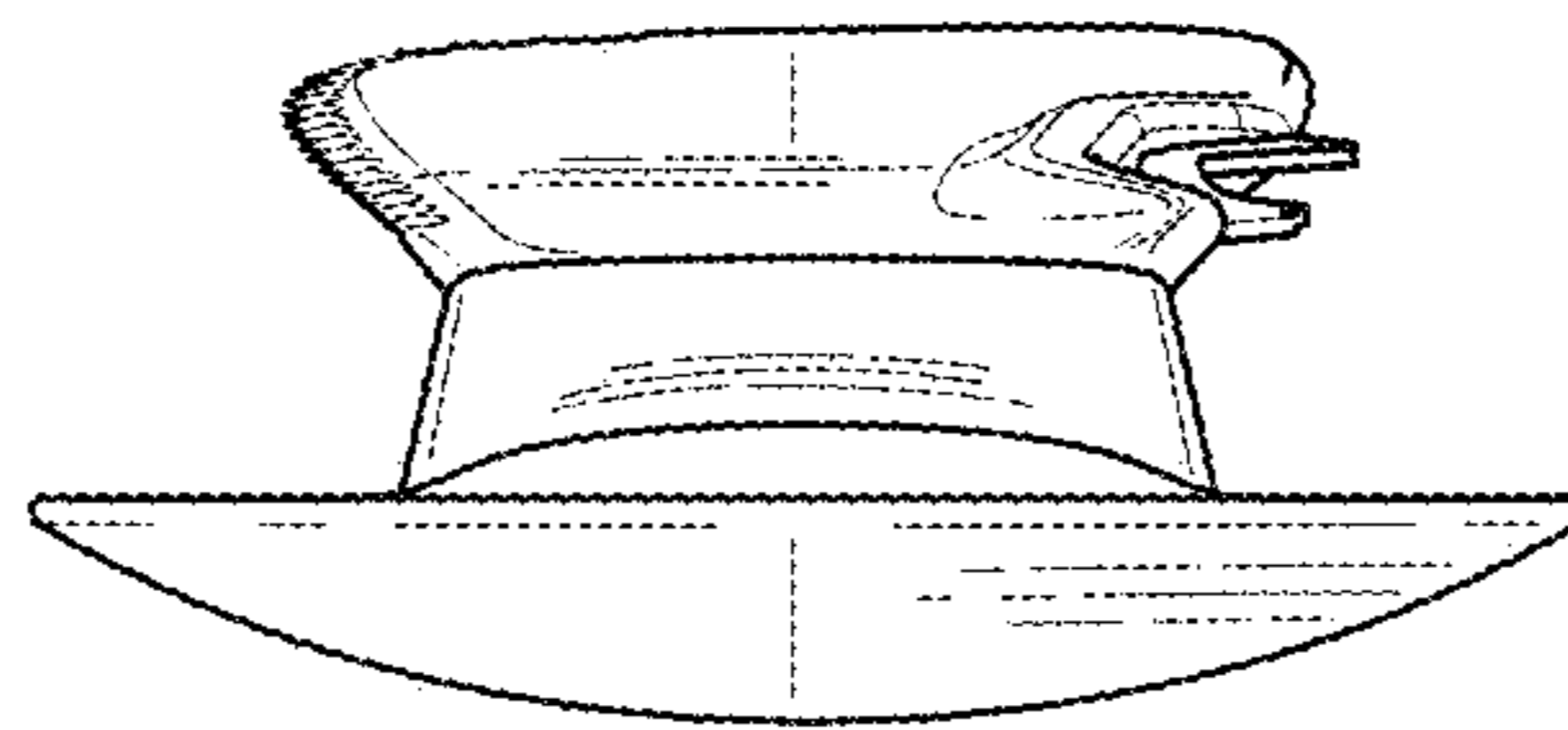

Fig. 2

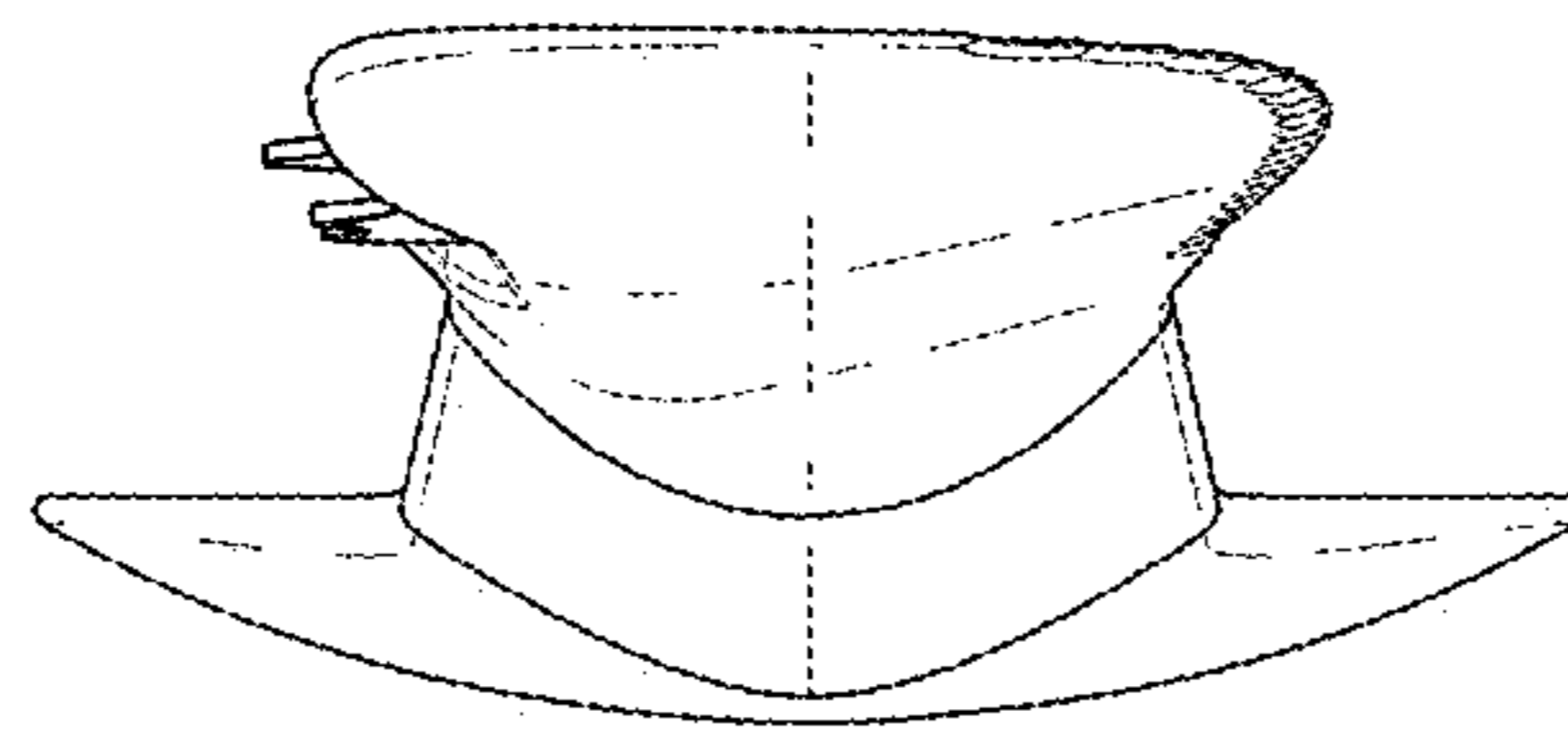

Fig. 3

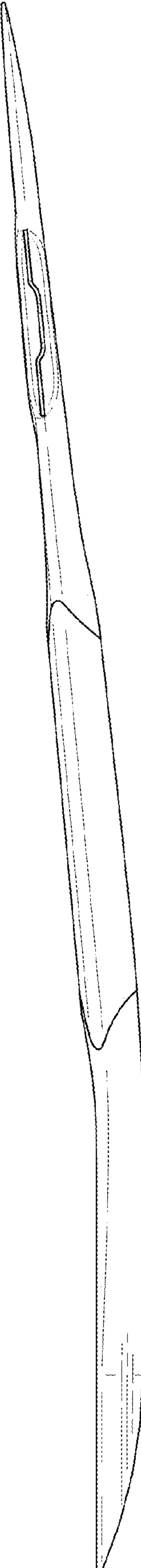

Fig. 4

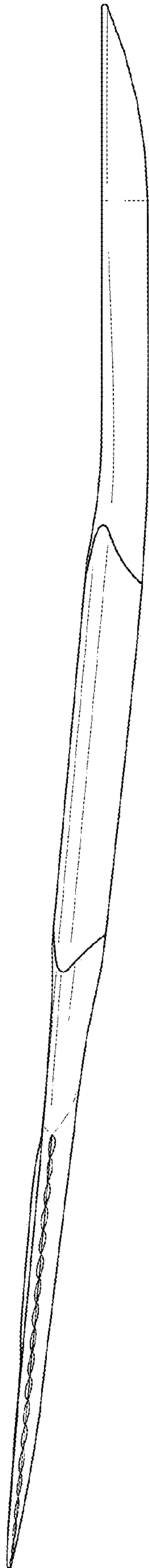

Fig. 5

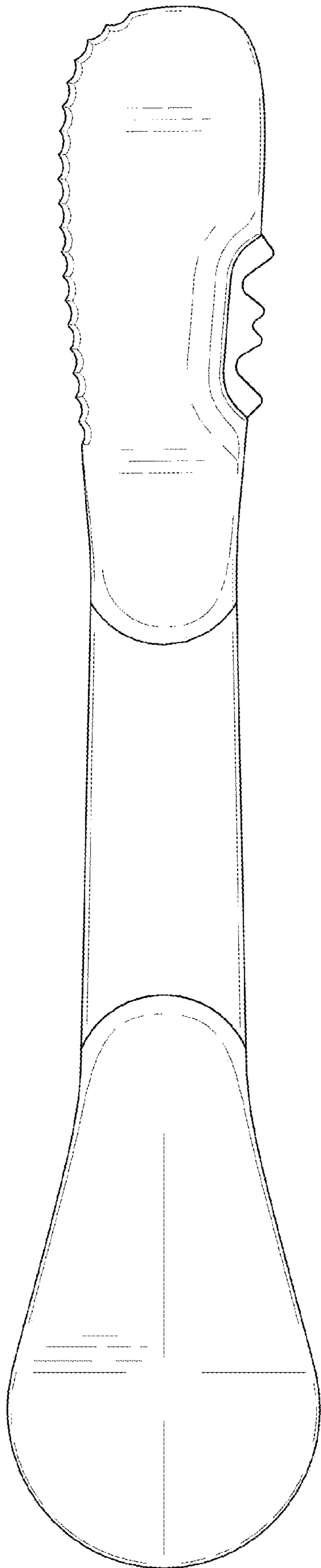

Fig. 6

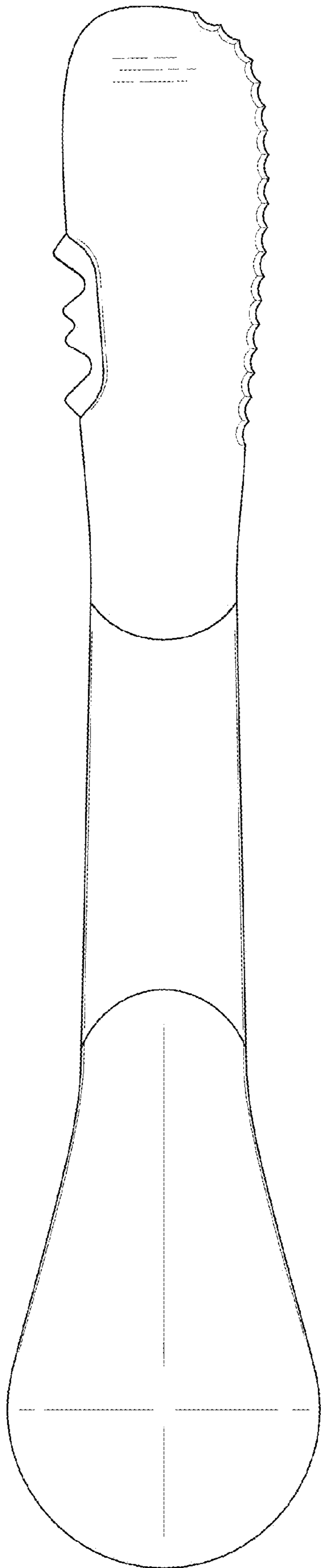

Fig. 7

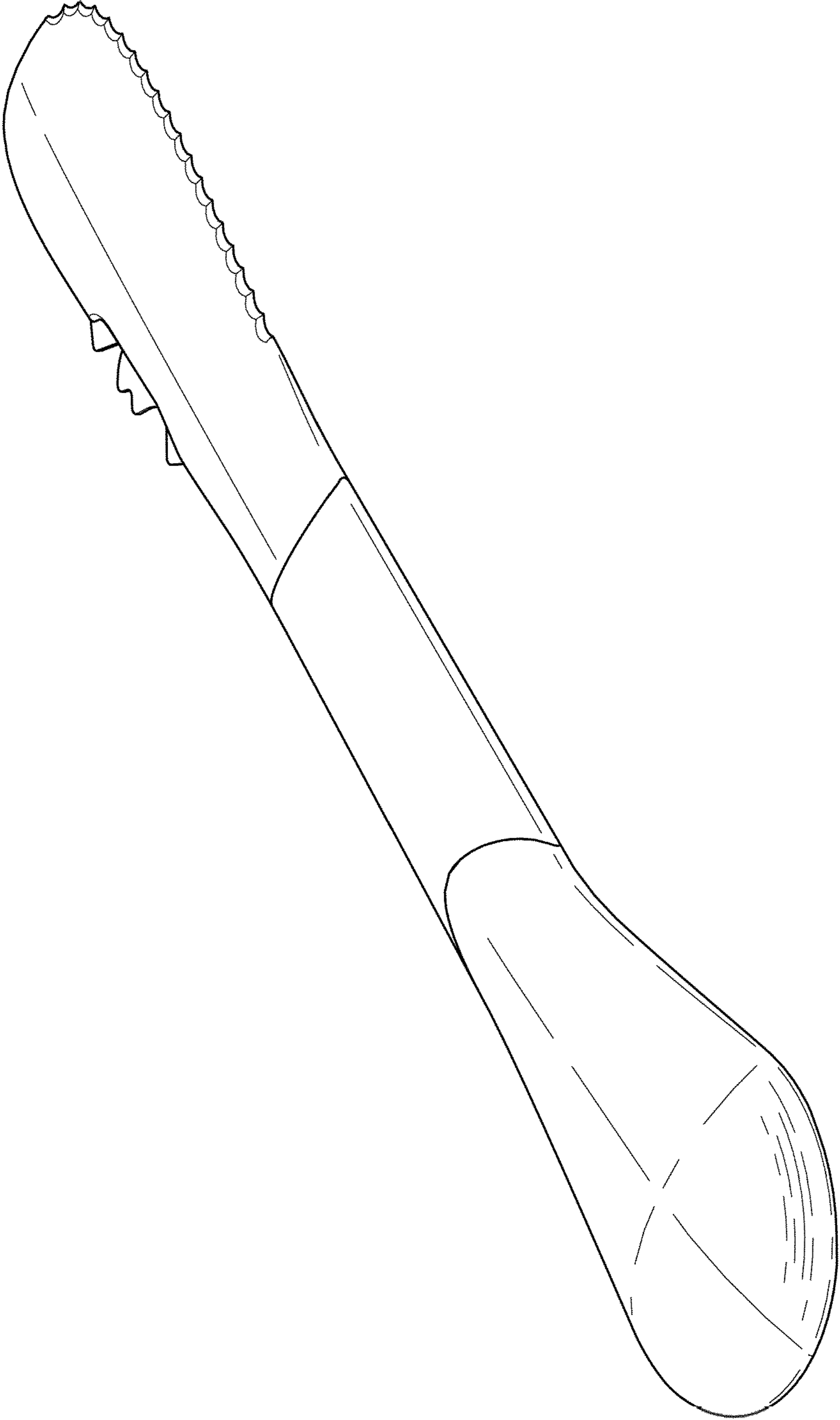

Fig. 8