



US00D897157S

(12) **United States Design Patent** (10) **Patent No.:** **US D897,157 S**  
**McCabe et al.** (45) **Date of Patent:** **\*\* Sep. 29, 2020**

- (54) **BEVERAGE CONTAINER**
- (71) Applicant: **Leapfrog Product Development LLC**,  
Chicago, IL (US)
- (72) Inventors: **Micaela K. McCabe**, Chicago, IL (US);  
**Steven N. Pinelli**, Ogden Dunes, IN  
(US); **Jingyan Wang**, Harbin (CN);  
**Glen C. Gilmore, III**, Naperville, IL  
(US); **Brian M. Clemens**, Burnsville,  
MN (US); **Richard E. Ellison**,  
Chicago, IL (US); **Kurtis M. Sward**,  
Anna Maria, FL (US)
- (73) Assignee: **Leapfrog Product Development LLC**,  
Chicago, IL (US)
- (\*\*) Term: **15 Years**
- (21) Appl. No.: **29/692,798**
- (22) Filed: **May 29, 2019**
- (51) **LOC (12) Cl.** ..... **07-01**
- (52) **U.S. Cl.**  
USPC ..... **D7/510; D7/511; D7/532**
- (58) **Field of Classification Search**  
USPC ..... D7/507, 509, 510, 511, 529, 531, 532,  
D7/523, 533, 534, 535, 536, 392.1, 296.1,  
D7/396.2; D9/531, 503, 516, 517, 435;  
D3/202  
CPC ..... A47G 19/22; A47G 19/2288; A47G  
19/2205; A47G 19/2266; A45F 3/16  
See application file for complete search history.

(56) **References Cited**  
U.S. PATENT DOCUMENTS

D364,810 S	12/1995	Meisner
D471,455 S	3/2003	Laveault et al.
D485,132 S	1/2004	Ohno et al.
D505,294 S	5/2005	Gauss
D508,185 S	8/2005	Gauss
D515,357 S	2/2006	Ward et al.
D528,862 S	9/2006	Li
D533,061 S	12/2006	Li

D564,841 S	3/2008	Clemens et al.
D579,722 S	11/2008	Sakulsacha et al.
D581,727 S	12/2008	Pinelli et al.
D592,456 S	5/2009	Pinelli et al.
D592,905 S	5/2009	Pinelli et al.
D592,913 S	5/2009	Pinelli et al.
7,546,933 B2	6/2009	Pinelli

(Continued)

**OTHER PUBLICATIONS**

- [https://www.zuluathletic.com/shop-all/atlas-glass-water-bottle.](https://www.zuluathletic.com/shop-all/atlas-glass-water-bottle)
  - [https://waterbottles.com/kor-vida-bottle-25-oz.](https://waterbottles.com/kor-vida-bottle-25-oz)
  - [https://www.thermos.com/genuine-thermos-brand-hydration-bottle-with-rotating-intake-meter-24oz.html.](https://www.thermos.com/genuine-thermos-brand-hydration-bottle-with-rotating-intake-meter-24oz.html)
  - [https://www.thermos.com/genuine-thermos-brand-shaker-bottle-with-integrated-mixer-24oz-clear-green-accent.html.](https://www.thermos.com/genuine-thermos-brand-shaker-bottle-with-integrated-mixer-24oz-clear-green-accent.html)
- (Continued)

*Primary Examiner* — Jae Liang  
(74) *Attorney, Agent, or Firm* — Barnes & Thornburg  
LLP

(57) **CLAIM**

We claim the ornamental design for a beverage container, as shown and described.

**DESCRIPTION**

FIG. 1 is a top perspective view of a beverage container according to the new design.

FIG. 2 is a bottom perspective view of the beverage container shown in FIG. 1.

FIG. 3 is a left side elevation view of the beverage container shown in FIG. 1.

FIG. 4 is a front elevation view of the beverage container shown in FIG. 1.

FIG. 5 is a right side elevation view of the beverage container shown in FIG. 1.

FIG. 6 is a rear elevation view of the beverage container shown in FIG. 1.

FIG. 7 is a top plan view of the beverage container shown in FIG. 1; and,

FIG. 8 is a bottom plan view of the beverage container shown in FIG. 1.

**1 Claim, 8 Drawing Sheets**

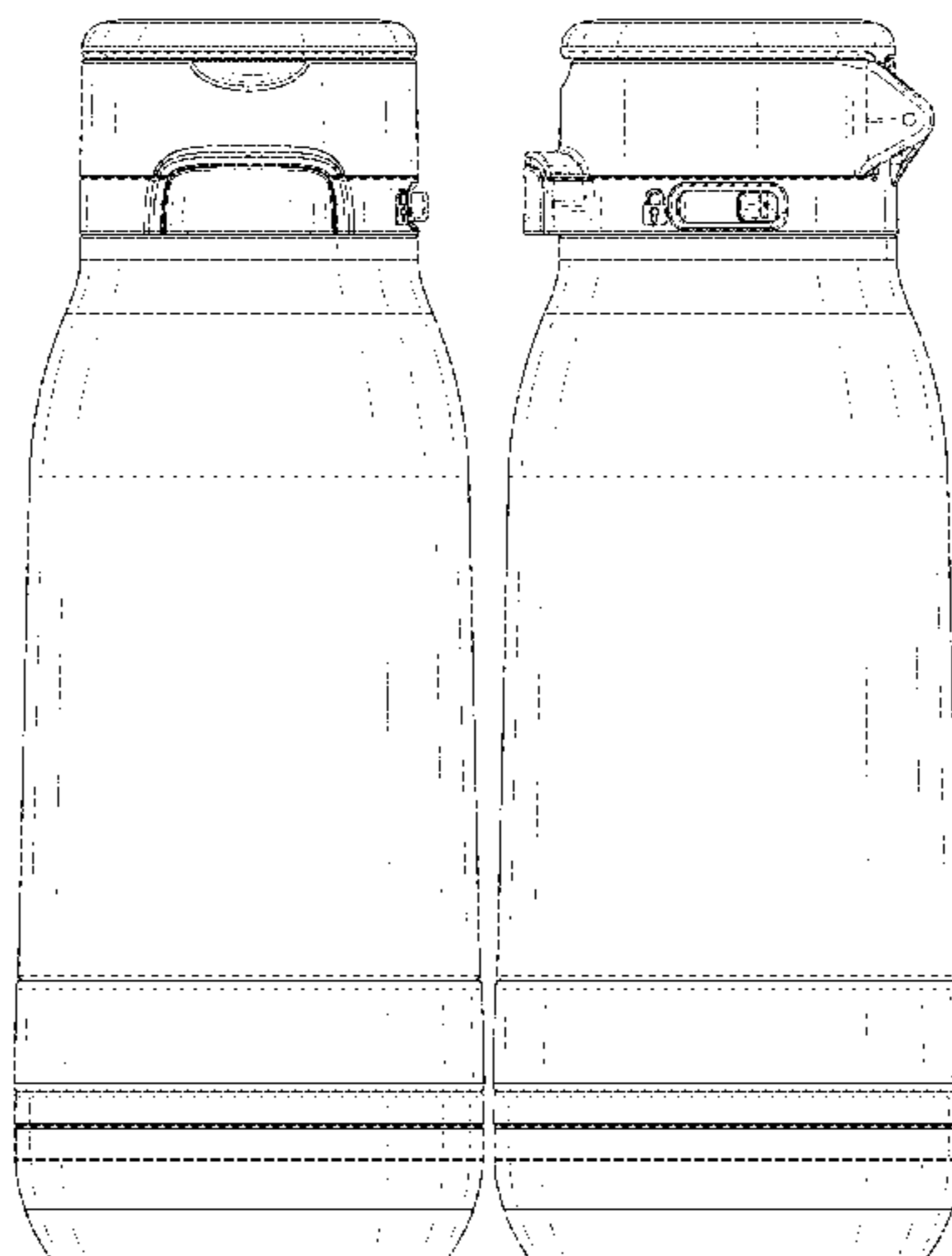

(56)

## References Cited

## U.S. PATENT DOCUMENTS

D609,964	S	2/2010	Lane	
D643,249	S	8/2011	Miller et al.	
7,997,442	B2	8/2011	Pinelli	
D655,580	S *	3/2012	Kotani .....	D7/608
D656,787	S	4/2012	Phillips et al.	
D661,945	S	6/2012	Eyal	
D675,060	S	1/2013	Lane	
8,360,267	B1	1/2013	Chiou et al.	
D676,708	S *	2/2013	Lane .....	D7/510
D686,871	S	7/2013	Lane	
D693,629	S	11/2013	Miller	
D693,630	S	11/2013	Hurley et al.	
8,579,133	B2	11/2013	Marcus et al.	
8,590,731	B2	11/2013	Pinelli	
D698,428	S *	1/2014	Sands .....	D23/314
D700,012	S	2/2014	Hurley et al.	
D700,802	S	3/2014	Miller	
8,978,906	B2	3/2015	Feeley et al.	
D725,966	S	4/2015	Boroski et al.	
D739,183	S	9/2015	Lane	
9,266,643	B2	2/2016	Marcus et al.	
D758,189	S	6/2016	Roth et al.	
D758,790	S	6/2016	Boroski	
D780,578	S	3/2017	Lane et al.	
D785,402	S	5/2017	Shirley et al.	
D793,804	S	8/2017	Herbst et al.	
D794,453	S	8/2017	Boroski et al.	
D795,011	S	8/2017	Pisarevsky	
D799,898	S	10/2017	Yao	
D802,993	S	11/2017	Joseph et al.	
D804,903	S	12/2017	Mason et al.	
D804,904	S *	12/2017	Noveletsky .....	D7/510
D808,220	S	1/2018	Burns et al.	
D809,384	S	2/2018	Best et al.	
D814,398	S	4/2018	Yasunaga	
D817,713	S	5/2018	Lin	
D818,767	S	5/2018	Nezu	
D821,136	S	6/2018	Silsby et al.	
D821,137	S	6/2018	Boroski	
D821,815	S	7/2018	Chung	
D822,427	S	7/2018	Sorensen et al.	
D831,425	S	10/2018	Best et al.	
D831,433	S	10/2018	Fleischhut	
D835,939	S	12/2018	Yee et al.	
D839,044	S	1/2019	Potter et al.	
D842,036	S *	3/2019	Ke .....	D7/507
D842,037	S *	3/2019	Chen .....	D7/507
D842,653	S *	3/2019	Osorio-Franco .....	D7/511
D848,787	S	5/2019	Tatsukawa et al.	
D853,181	S	7/2019	Stanton	
D853,784	S	7/2019	Wu	
D865,457	S *	11/2019	Kotani .....	D7/608
D869,230	S	12/2019	Hao	
D870,509	S	12/2019	Bo	
2011/0089059	A1	4/2011	Lane et al.	
2012/0312832	A1	12/2012	Lane	
2014/0339177	A1	11/2014	Lane	
2015/0282654	A1	10/2015	Kurabe et al.	
2017/0297785	A1	10/2017	Maruyama et al.	

## OTHER PUBLICATIONS

<https://www.tervis.com/turtle-sunset-stainless-steel-24oz-stainless-water-bottle-1362572.html>.  
<https://www.swell.com/shop/swell/bottles/>.  
<http://www.pogogear.com/32oz-tritan-straw>.  
<http://www.pogogear.com/32oz-tritan-chug>.  
<http://www.pogogear.com/18oz-tritan-chug>.  
<https://www.elloproducts.com/water-bottles/chi-24oz-plastic-water-bottle>.  
<https://www.elloproducts.com/kids/dash-16oz-tritan-plastic-water-bottle>.  
<https://www.elloproducts.com/tumblers/cru-stemless-wine-glass-set-with-silicone-protection>.  
 Aladdin Water Bottle (1 page).  
<https://www.elloproducts.com/water-bottles/elsie-22oz-glass-water-bottle>.  
<https://www.elloproducts.com/tumblers/beacon-24oz-vacuum-insulated-stainless-tumbler>.  
<https://www.elloproducts.com/kids/rise-12oz-vacuum-insulated-stainless-steel-tumbler>.  
<https://www.elloproducts.com/travel-mugs/hammertime-18oz-vacuum-insulated-stainless-steel-travel-mug>.  
<https://www.elloproducts.com/water-bottles/pure-20oz-glass-water-bottle>.  
<https://www.elloproducts.com/kids/max-12oz-vacuum-insulated-stainless-steel-kids-water-bottle>.  
<https://www.elloproducts.com/water-bottles/syndicate-20oz-glass-water-bottle>.  
 Mason Glass Jar (1 page).  
[https://www.camelbak.com/en/bottles/R02056-Eddy\\_75L\\_2019?color=6bbd0584f3a64b0eb30d406f7e03797e](https://www.camelbak.com/en/bottles/R02056-Eddy_75L_2019?color=6bbd0584f3a64b0eb30d406f7e03797e).  
<https://www.gocontigo.com/20-oz-autoseal-west-loop-stainless-travel-mug-with-easy-clean-lid.html>.  
<https://www.gocontigo.com/14-oz-autospout-striker-kids-water-bottle.html>.  
<https://www.zojirushi.com/app/product/smyae>.  
<https://www.zojirushi.com/app/product/smkc>.  
<https://www.zojirushi.com/app/product/sjjs>.  
<https://www.zojirushi.com/app/product/smqhe>.  
<https://www.zojirushi.com/app/product/smtae>.  
<https://www.zojirushi.com/app/product/smta>.  
<https://www.zojirushi.com/app/product/smse>.  
<https://www.zojirushi.com/app/product/smsd>.  
<https://www.zojirushi.com/app/product/smshe>.  
<https://www.zojirushi.com/app/product/smke>.  
<https://www.zojirushi.com/app/product/smsc>.  
<https://www.zojirushi.com/app/product/smpc>.  
<https://www.zojirushi.com/app/product/smpb>.  
<https://www.pinterest.ru/pin/12666442685646757/>.  
[https://www.coleman.com/all-camp-kitchen/drinkware/switch-ss/col\\_2038485\\_pr/COL\\_2038485](https://www.coleman.com/all-camp-kitchen/drinkware/switch-ss/col_2038485_pr/COL_2038485).  
<https://corkcicle.com/products/classic-arctican?variant=475182759951>.  
 ELLO Reflex Beverage Container (1 page).

\* cited by examiner



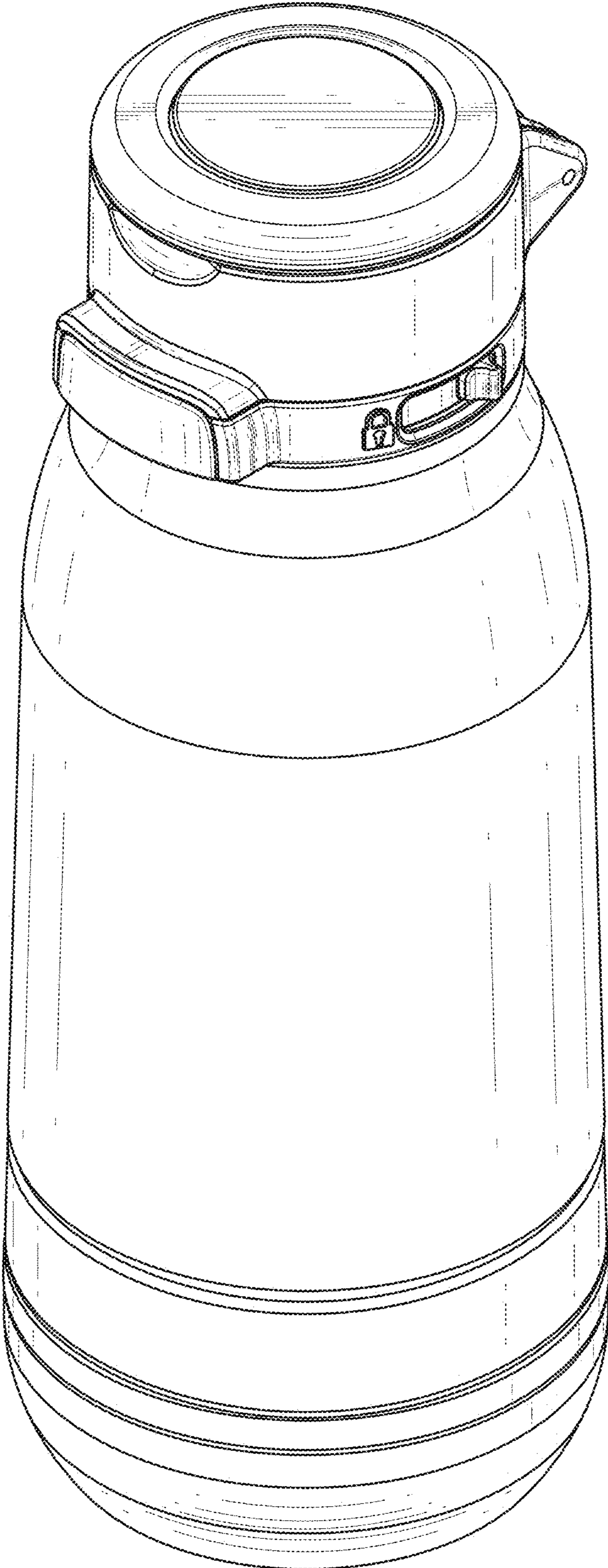

FIG. 1

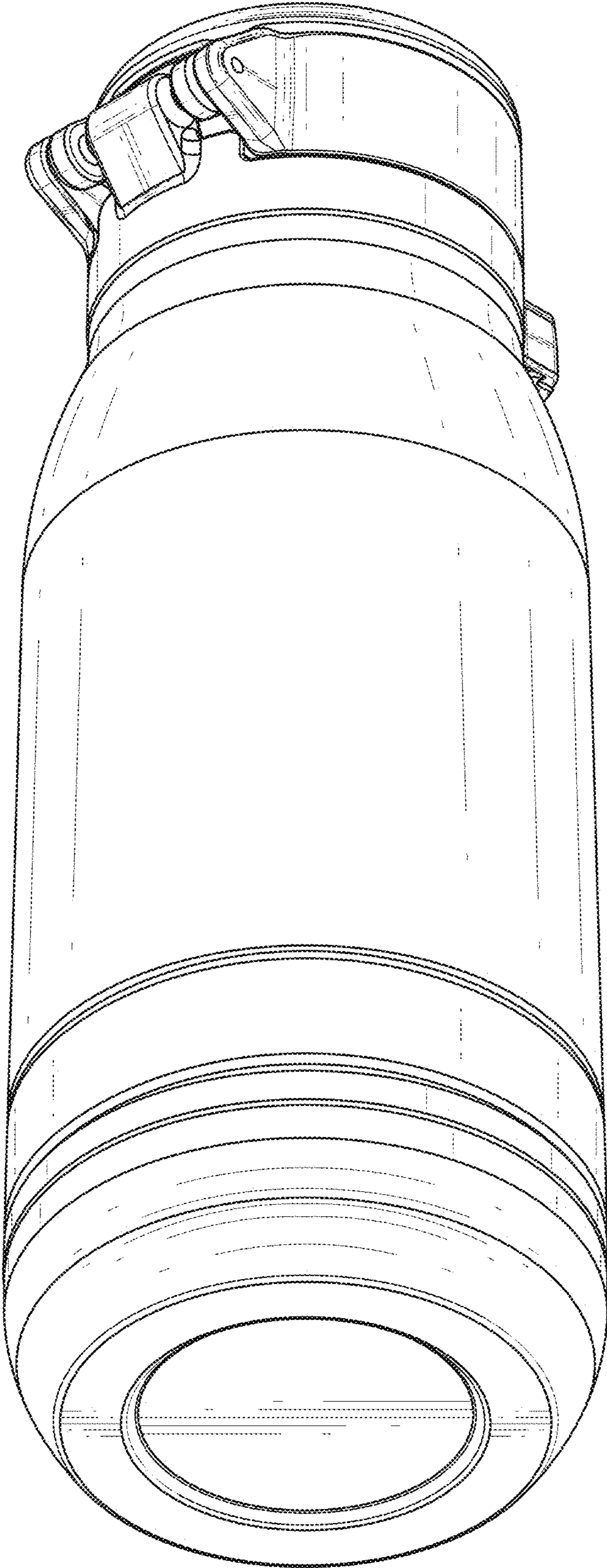

FIG. 2

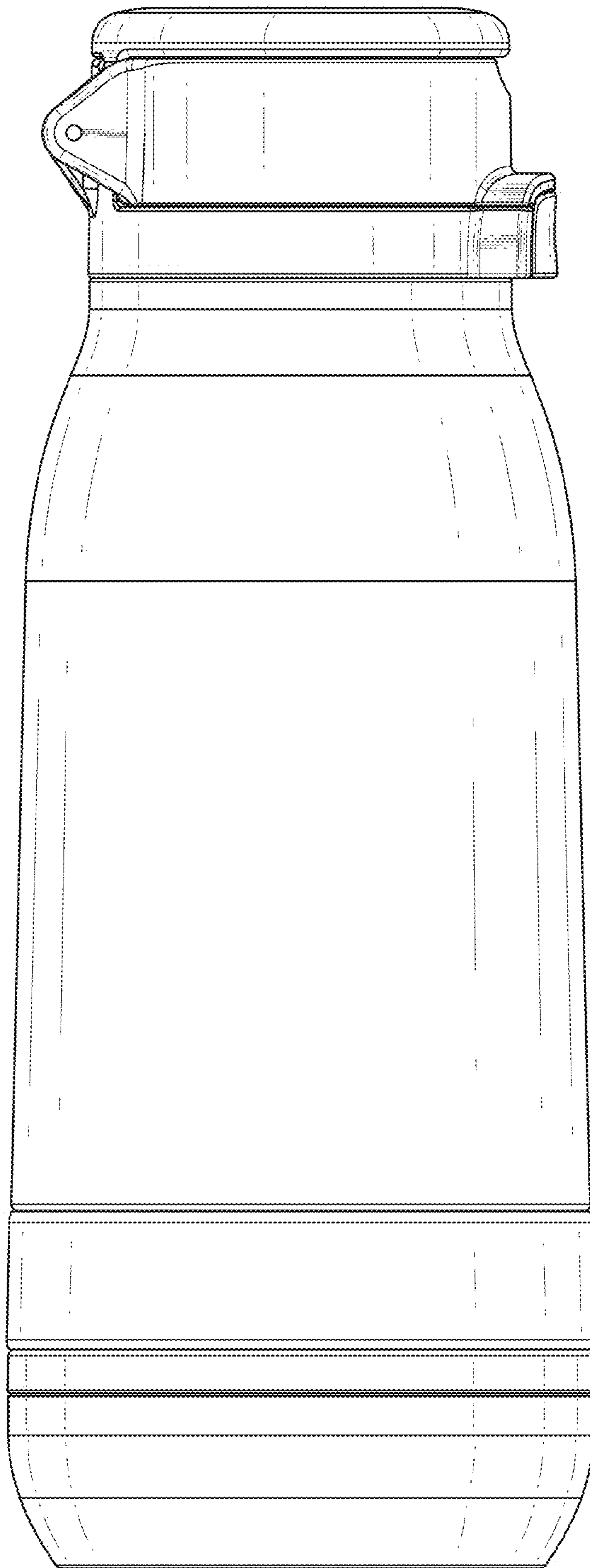

FIG. 3

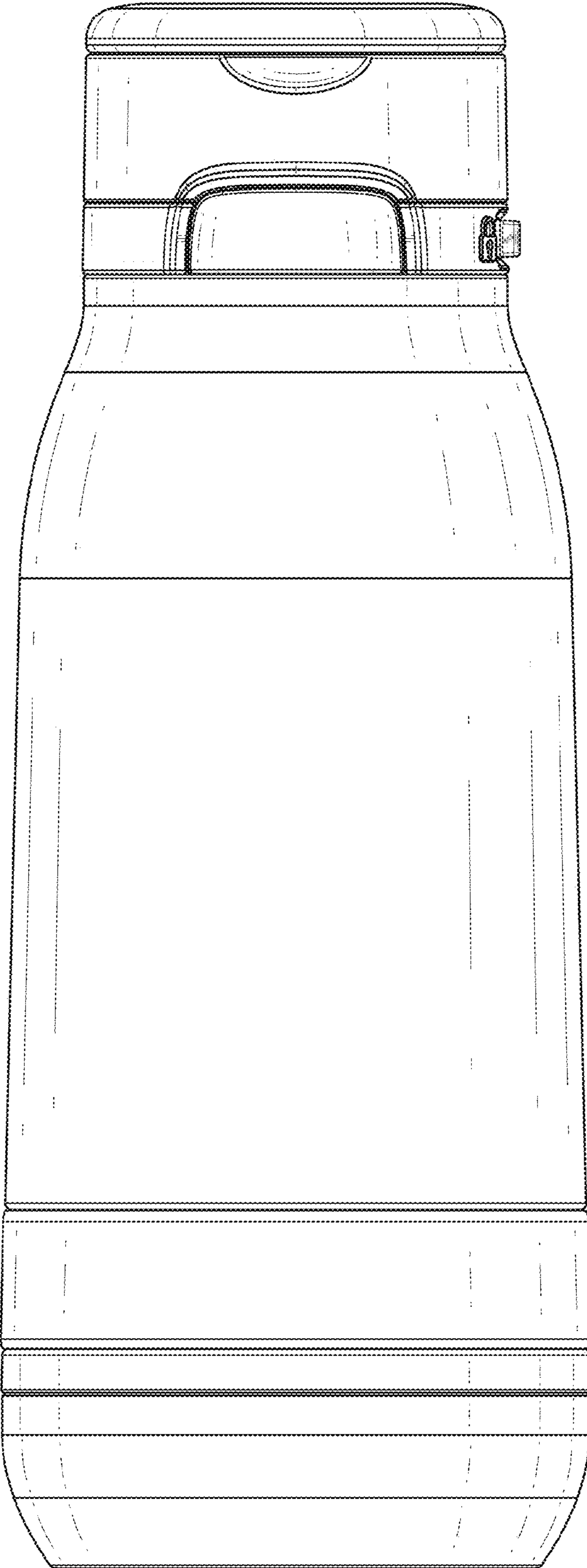

FIG. 4

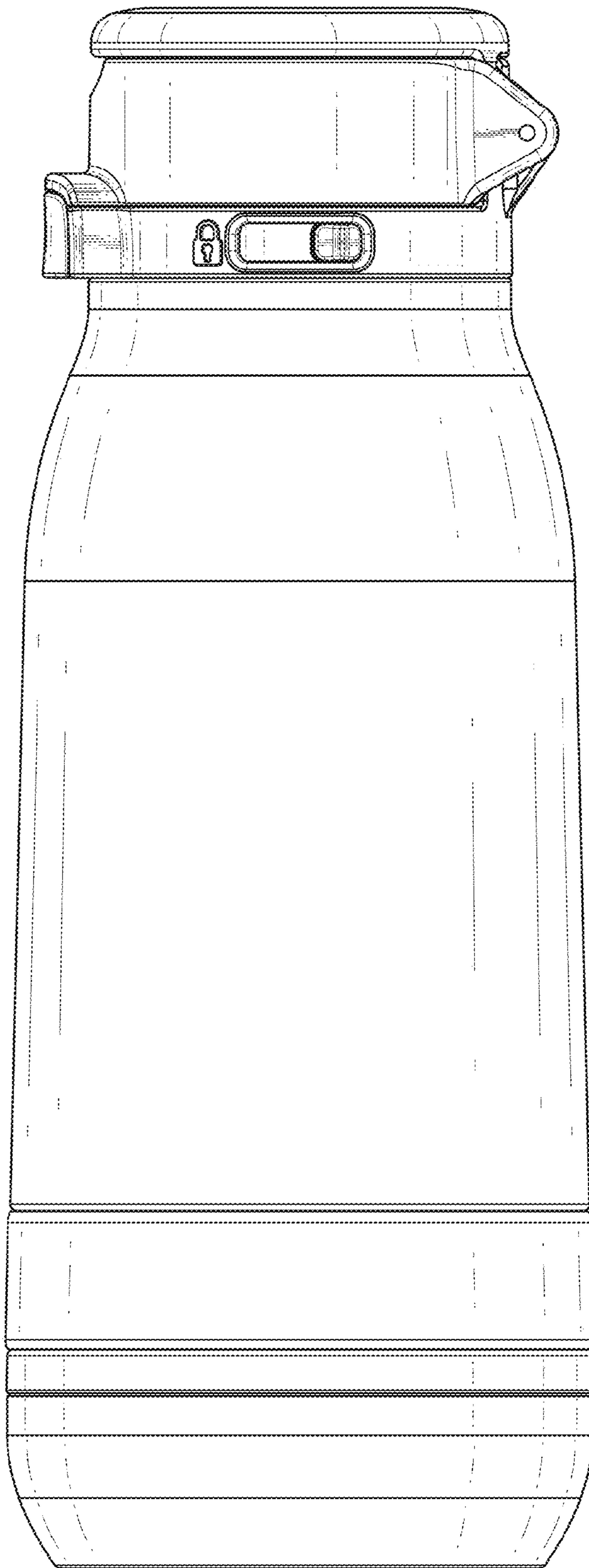

FIG. 5



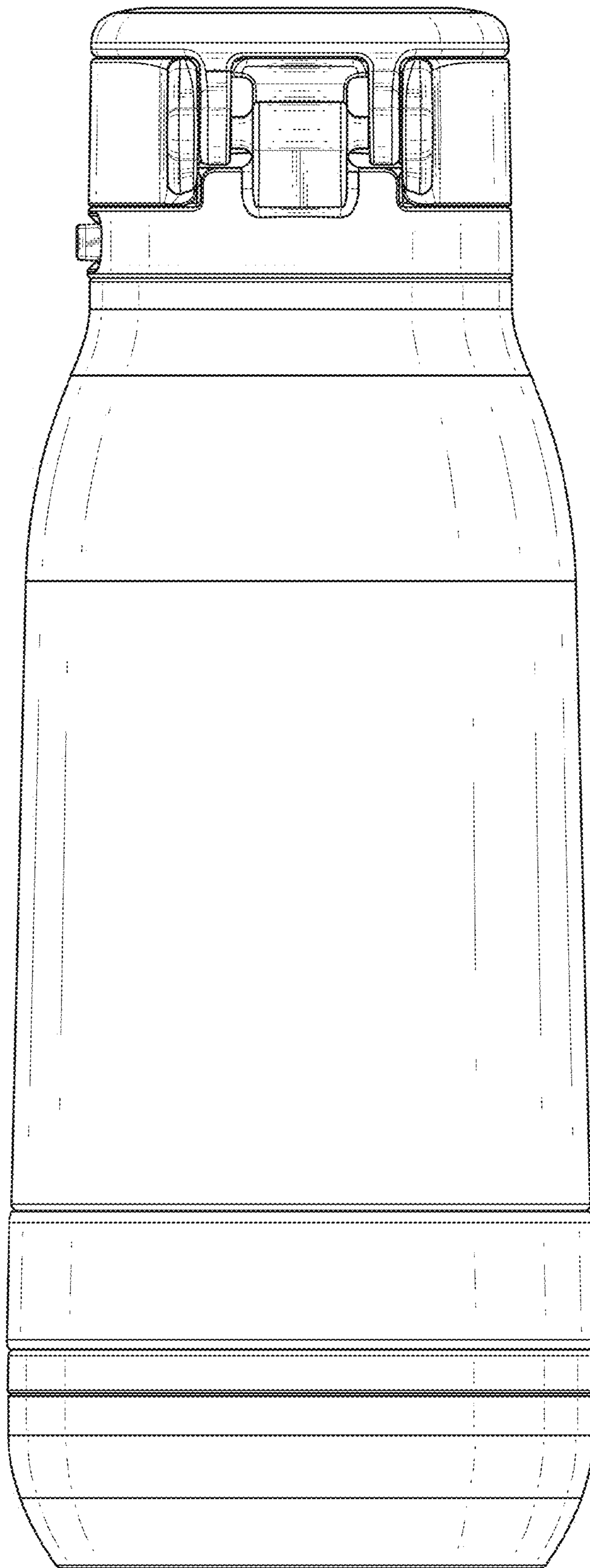

FIG. 6



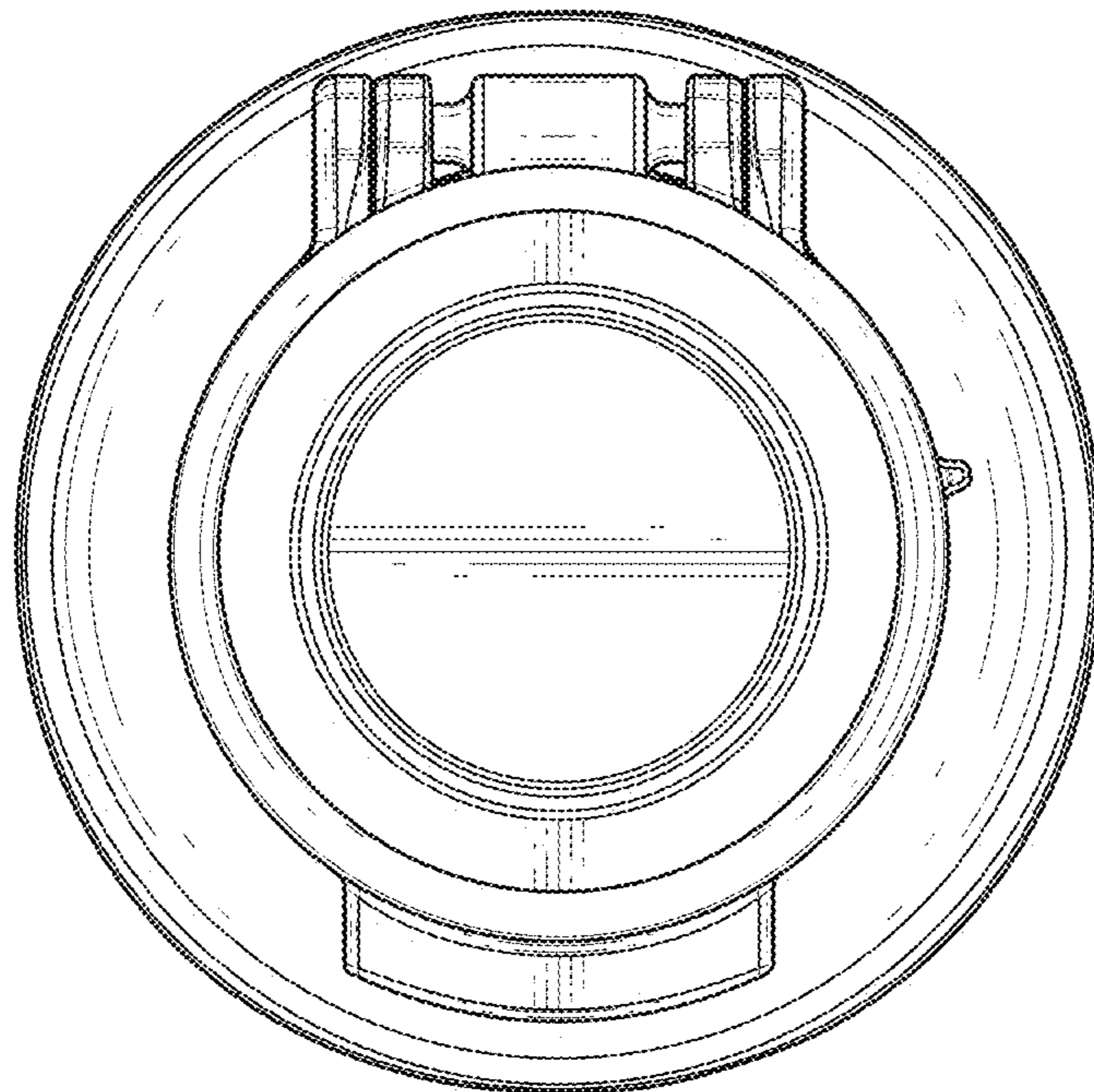

FIG. 7

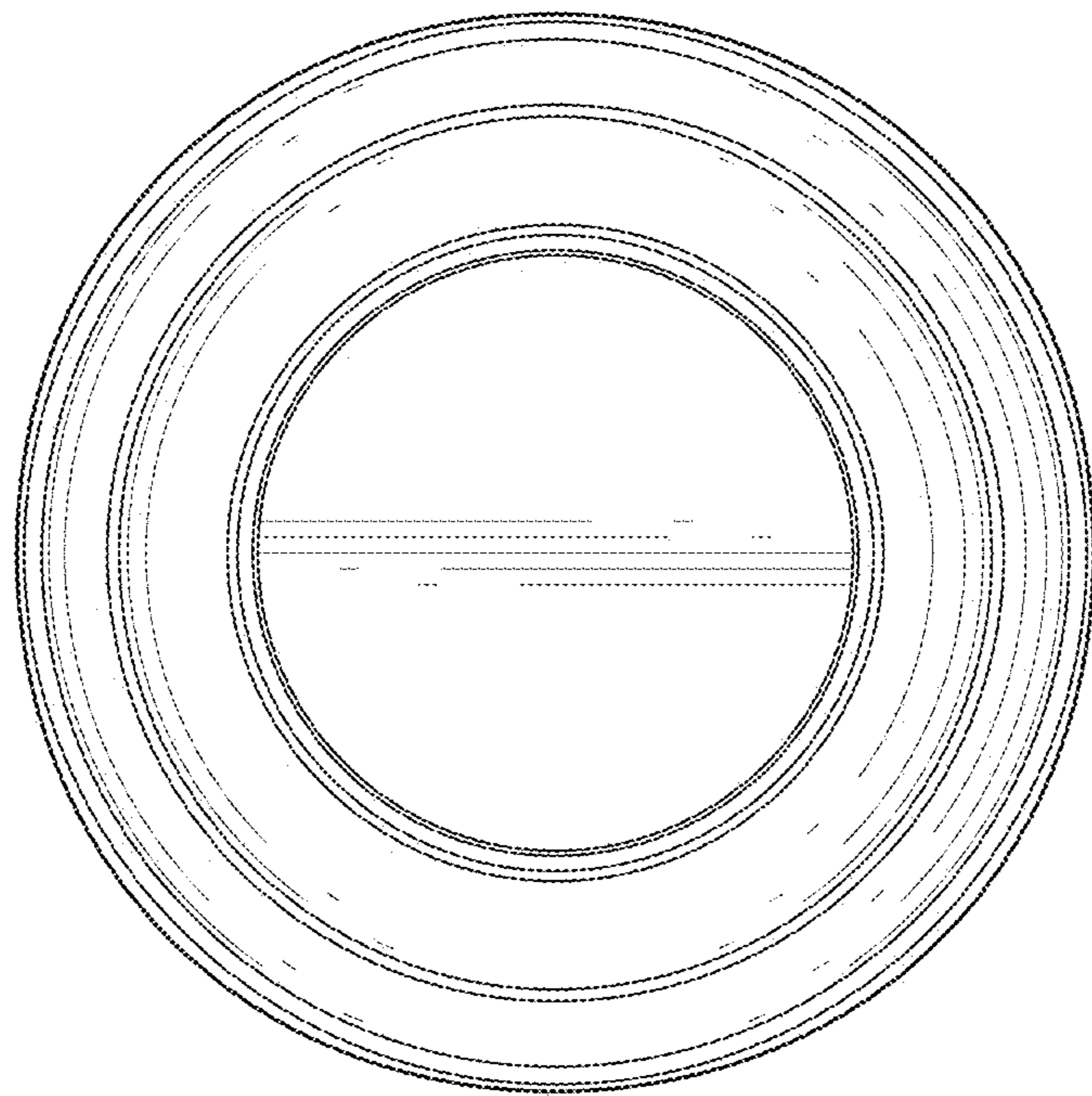

FIG. 8