



US00D896885S

(12) **United States Design Patent** (10) **Patent No.:** **US D896,885 S**  
**Li et al.** (45) **Date of Patent:** **\*\* Sep. 22, 2020**

(54) **PHOTO PRINTER**

(56) **References Cited**

(71) Applicant: **BEIJING XIAOMI MOBILE SOFTWARE CO., LTD.**, Beijing (CN)

U.S. PATENT DOCUMENTS

(72) Inventors: **Ningning Li**, Beijing (CN); **Mengling Yu**, Beijing (CN); **Zhidan Zou**, Beijing (CN)

|            |   |         |                |       |          |
|------------|---|---------|----------------|-------|----------|
| D197,096 S | * | 12/1963 | Gugelot et al. | ..... | D18/36   |
| D584,346 S | * | 1/2009  | Sumi           | ..... | D18/50   |
| D643,462 S | * | 8/2011  | Yamashita      | ..... | D18/50   |
| D737,895 S | * | 9/2015  | Nanno          | ..... | D18/50   |
| D744,028 S | * | 11/2015 | Odachi         | ..... | D18/50   |
| D770,565 S | * | 11/2016 | Tanaka         | ..... | D18/50   |
| D815,683 S | * | 4/2018  | Tanaka         | ..... | D18/50   |
| D827,705 S | * | 9/2018  | Gosselin       | ..... | D18/34.3 |
| D844,052 S | * | 3/2019  | Oishi          | ..... | D18/50   |
| D850,528 S | * | 6/2019  | Gosselin       | ..... | D18/34.3 |
| D864,289 S | * | 10/2019 | Higuchi        | ..... | D18/50   |

(73) Assignee: **Beijing Xiaomi Mobile Software Co., Ltd.**, Beijing (CN)

(\*\*) Term: **15 Years**

\* cited by examiner

(21) Appl. No.: **35/507,332**

*Primary Examiner* — Khawaja Anwar

(22) Filed: **Feb. 26, 2019**

(74) *Attorney, Agent, or Firm* — Syncoda LLC; Feng Ma

(80) **Hague Agreement Data**

Int. Filing Date: **Feb. 26, 2019**  
Int. Reg. No.: **DM/201327**  
Int. Reg. Date: **Feb. 26, 2019**  
Int. Reg. Pub. Date: **Aug. 30, 2019**

(57) **CLAIM**

The ornamental design for a photo printer, as shown and described.

(30) **Foreign Application Priority Data**

Sep. 3, 2018 (CN) ..... 2018 3 0492442

**DESCRIPTION**

(51) **LOC (12) Cl.** ..... **18-02**

(52) **U.S. Cl.**  
USPC ..... **D18/50**

(58) **Field of Classification Search**  
USPC ..... D18/34.3, 36, 43, 46, 47, 50, 56, 59  
CPC .. B41F 15/26; B41F 33/0036; B41F 33/0045;  
B41J 2/17546; G03G 15/04; G03G 15/5016; G03G 15/60; G03G 15/607;  
G03G 21/0094; G03G 21/1619; G03G 21/1647; G03G 21/1666

1. Photo printer
- 1.1 : Front
- 1.2 : Back
- 1.3 : Left
- 1.4 : Right
- 1.5 : Top
- 1.6 : Bottom
- 1.7 : Perspective view 1
- 1.8 : Perspective view 2

See application file for complete search history.

**1 Claim, 8 Drawing Sheets**

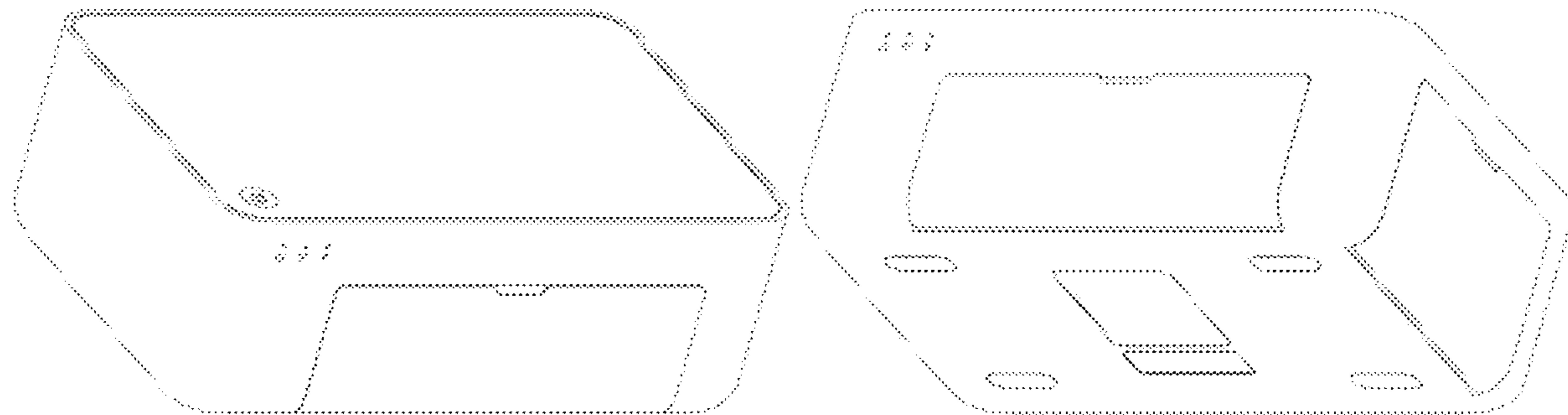

**1.1**

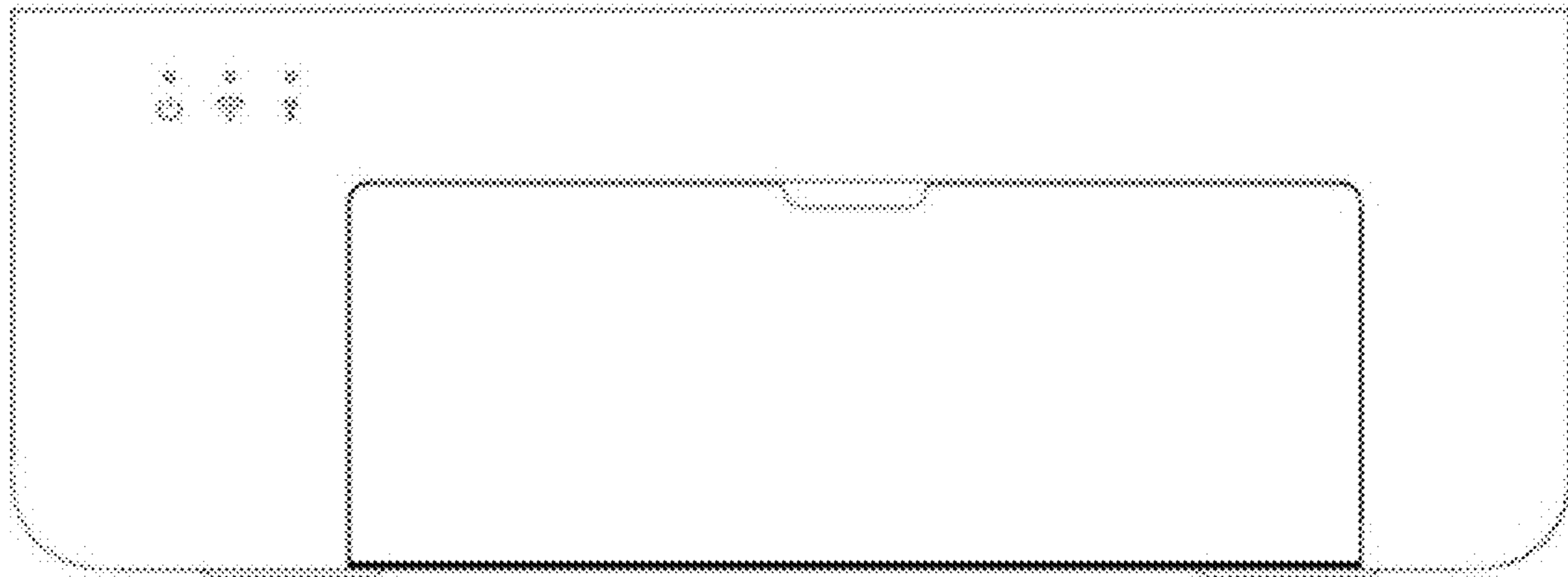

1.2

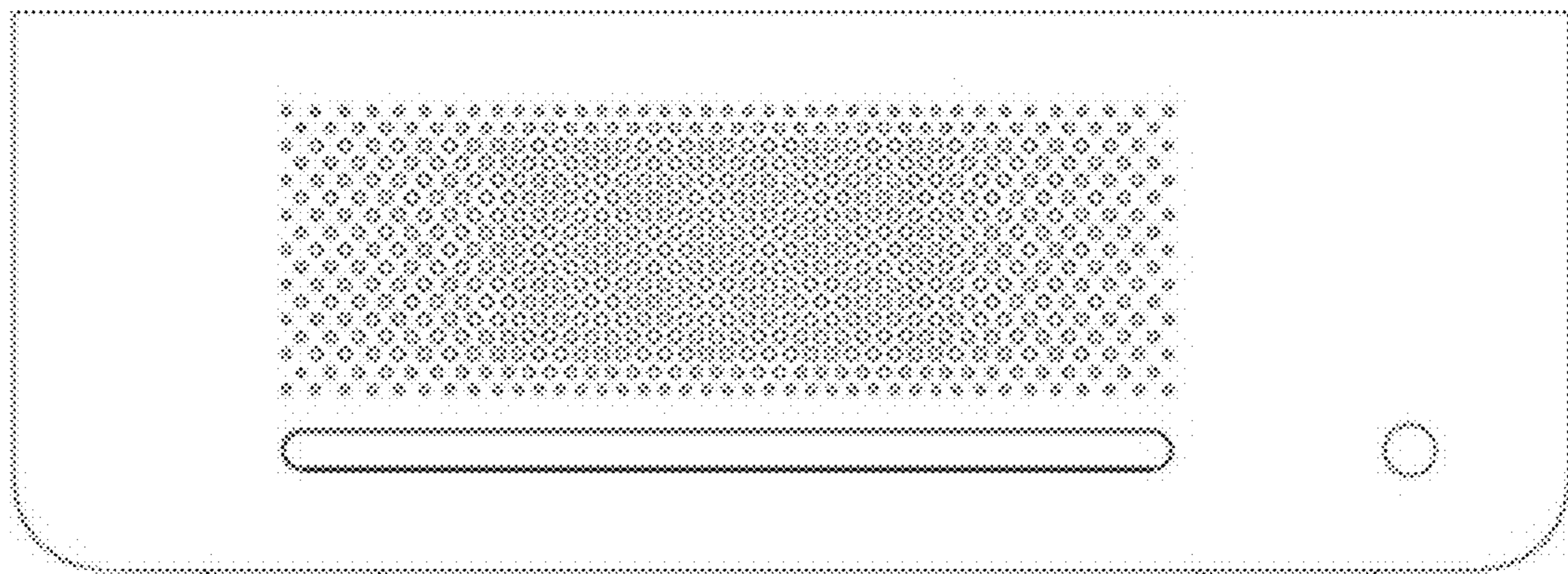

**1.3**

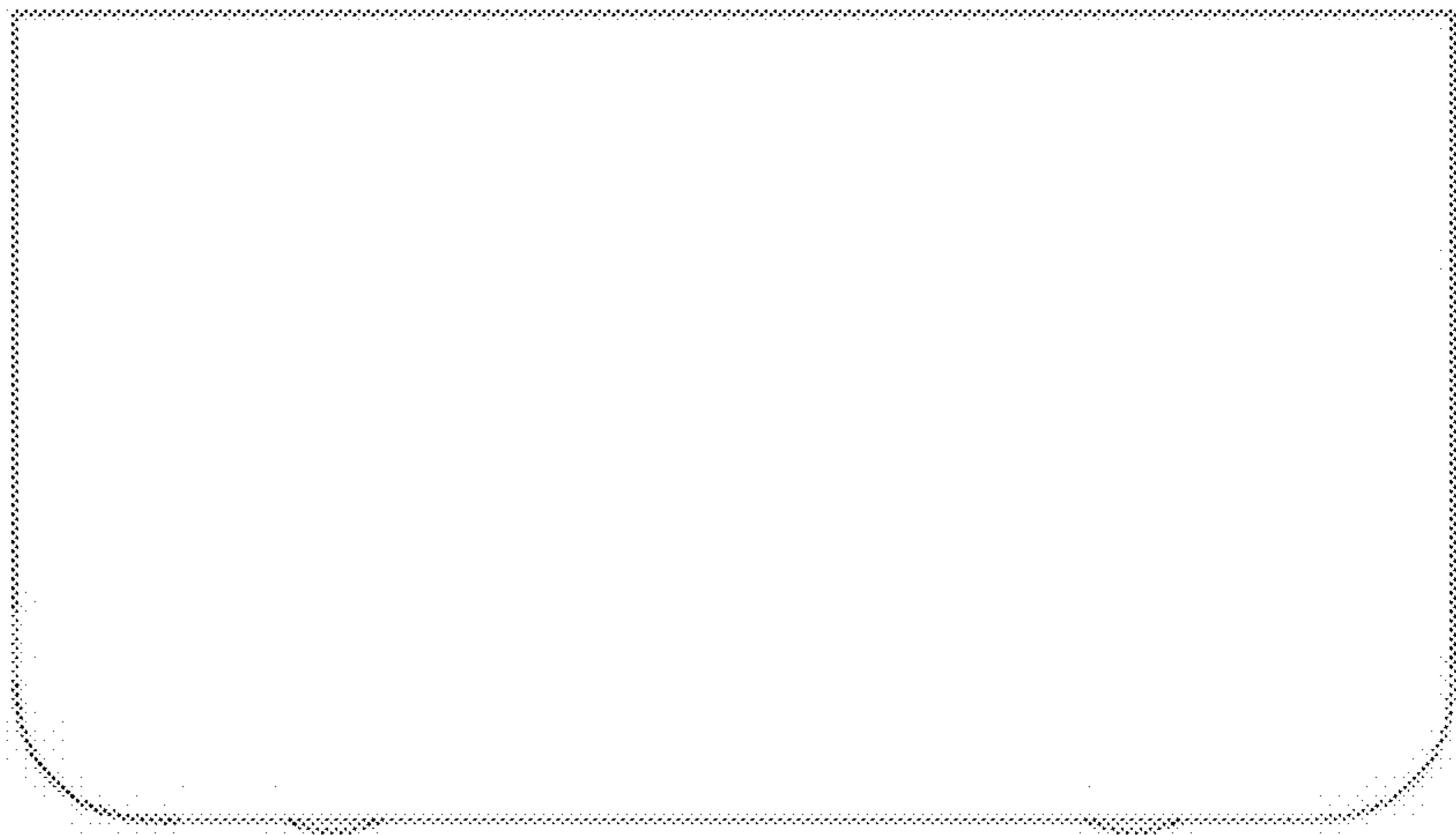

1.4

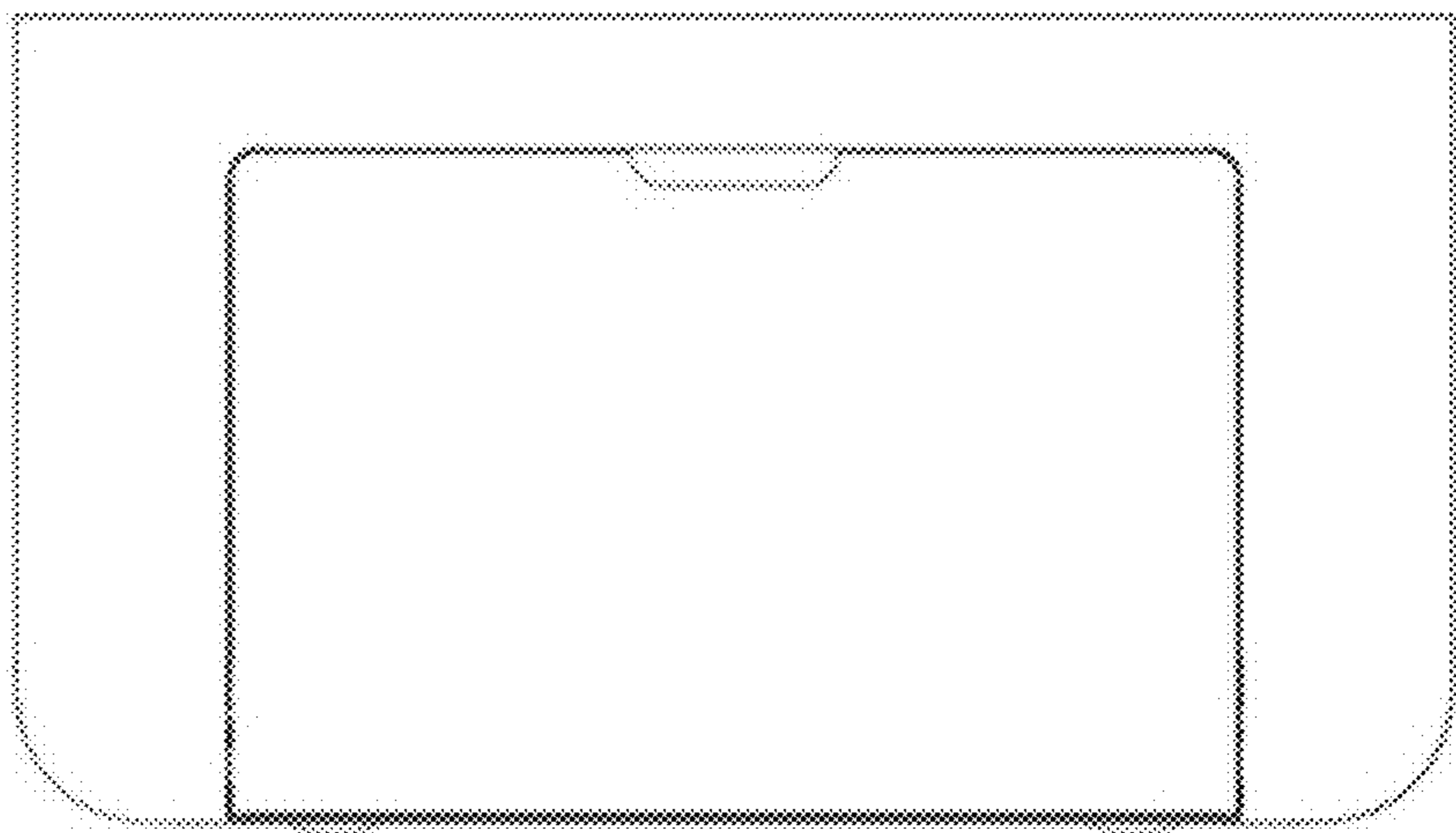

1.5

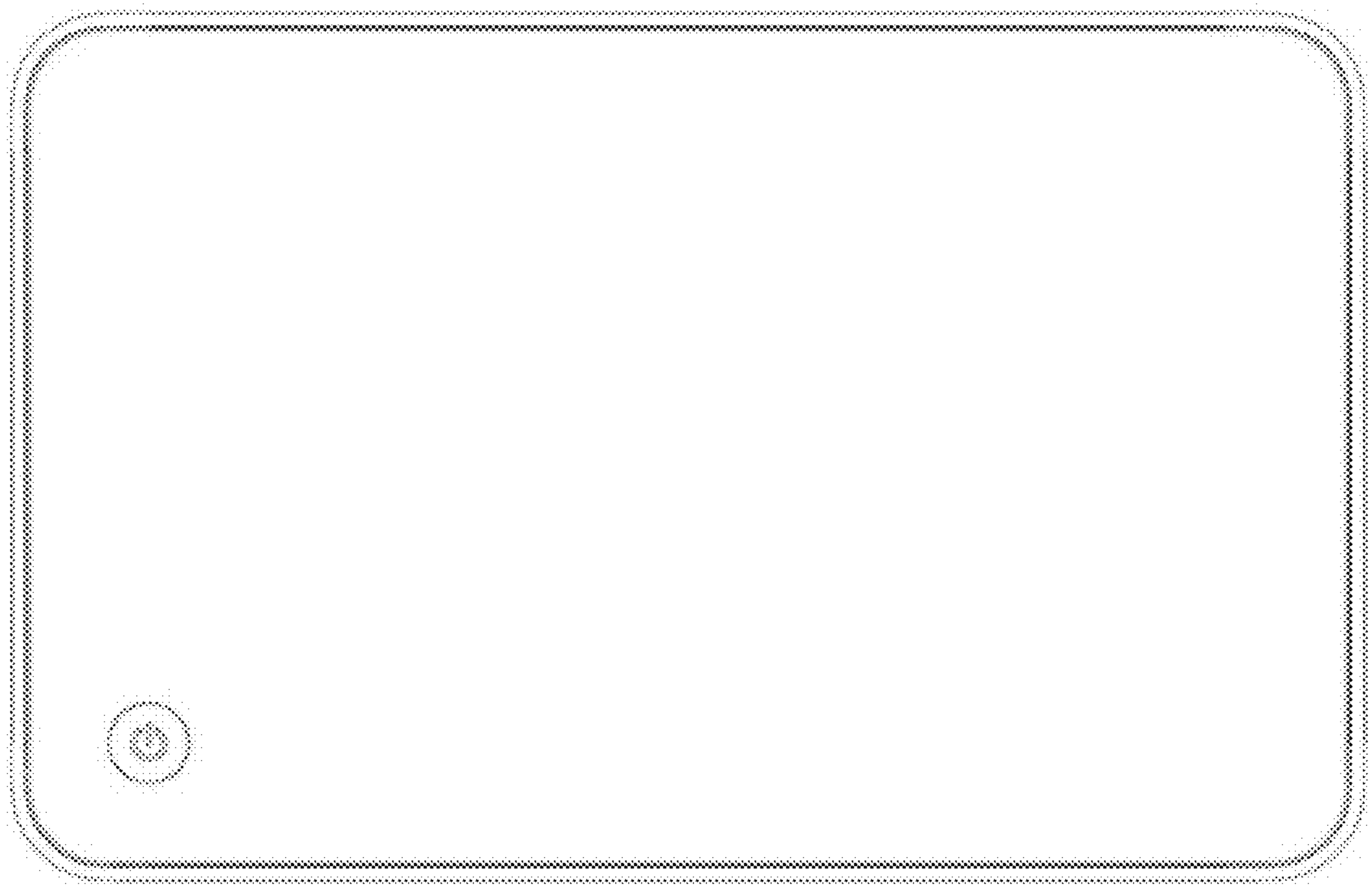

1.6

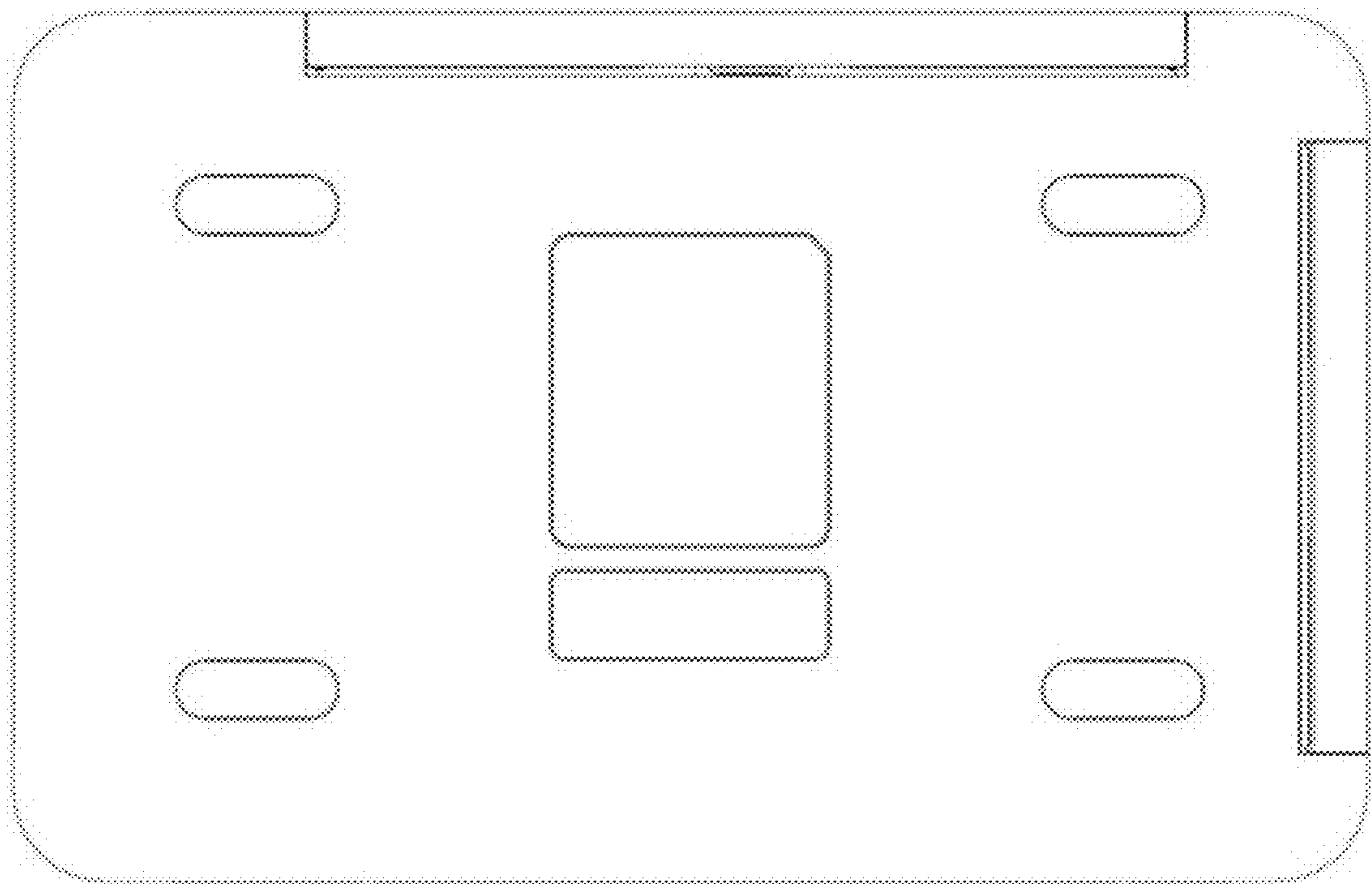

1.7

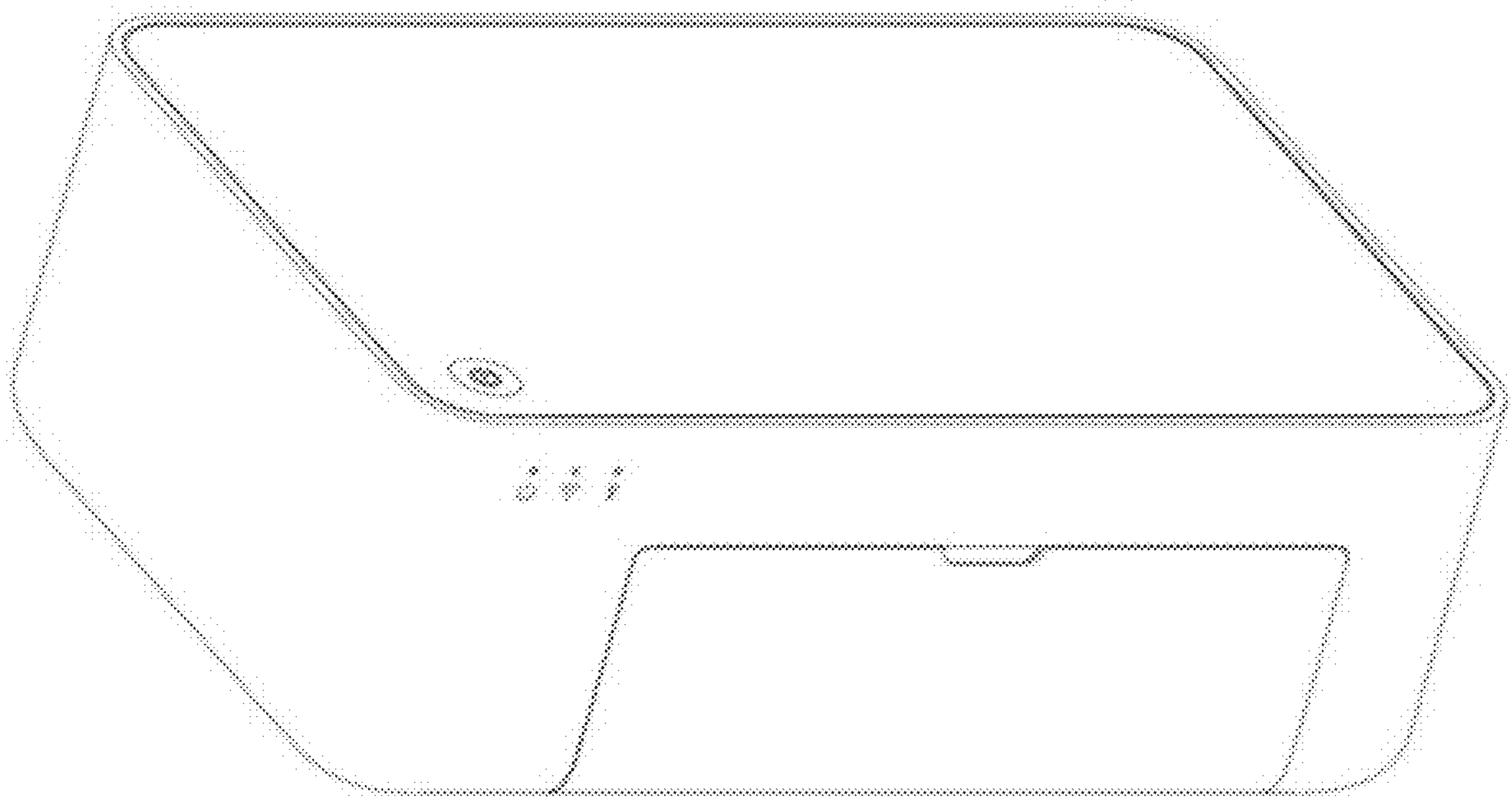



1.8

