



US00D896789S

(12) **United States Design Patent**
Chang et al.

(10) **Patent No.:** **US D896,789 S**

(45) **Date of Patent:** **** Sep. 22, 2020**

(54) **EARPHONE**

(71) Applicant: **Quanta Computer Inc.**, Taoyuan (TW)

(72) Inventors: **Jung-Wen Chang**, Taoyuan (TW);
Kao-Yu Hsu, Taoyuan (TW)

(73) Assignee: **QUANTA COMPUTER INC.**,
Guishan Dist., Taoyuan (TW)

(**) Term: **15 Years**

(21) Appl. No.: **29/690,941**

(22) Filed: **May 13, 2019**

(30) **Foreign Application Priority Data**

Jan. 21, 2019 (TW) 108300386

(51) **LOC (12) Cl.** **14-01**

(52) **U.S. Cl.**
USPC **D14/223**

(58) **Field of Classification Search**
USPC D14/223, 205, 206; D24/174; 128/864,
128/865, 866; 181/129, 130, 135;
379/430, 431; 381/380, 381, 322-324,
381/330; 455/90.3, 575, 1, 569.1
CPC H04R 1/10; H04R 25/00; H04R 1/1016;
H04R 1/1066; H04R 5/033; H04R
5/0335; H04R 1/1091; H04R 1/1058;
H04R 1/105; H04R 1/1083
See application file for complete search history.

(56) **References Cited**

U.S. PATENT DOCUMENTS

D525,962 S * 8/2006 Elson D14/142
D613,273 S * 4/2010 Liner D14/223

D616,464 S * 5/2010 Park D14/203.1
D627,330 S * 11/2010 Otsuka D14/192
D753,091 S * 4/2016 Miyake D14/205
D762,858 S * 8/2016 Iwabuchi D24/174
D798,838 S * 10/2017 DiTullo D14/214
D820,240 S * 6/2018 Holliday D14/223
D839,242 S * 1/2019 Pang D14/223
D862,408 S * 10/2019 Deng D14/188
D887,556 S * 6/2020 Lockenwitz D24/173
2007/0243723 A1 * 10/2007 Liao H04B 1/034
439/1
2008/0032737 A1 * 2/2008 Liu H04M 1/72522
455/556.1

* cited by examiner

Primary Examiner — Katie Jane Stofko

(74) *Attorney, Agent, or Firm* — McClure, Qualey &
Rodack, LLP

(57) **CLAIM**

The ornamental design for an earphone, as shown and described.

DESCRIPTION

FIG. 1 is a front and right perspective view of an earphone, showing our new design;
FIG. 2 is a front view thereof;
FIG. 3 is a rear view thereof;
FIG. 4 is a left side view thereof;
FIG. 5 is a right side view thereof;
FIG. 6 is a top plan view thereof;
FIG. 7 is a bottom plan view thereof; and,
FIG. 8 is a rear and right perspective view thereof.

1 Claim, 8 Drawing Sheets

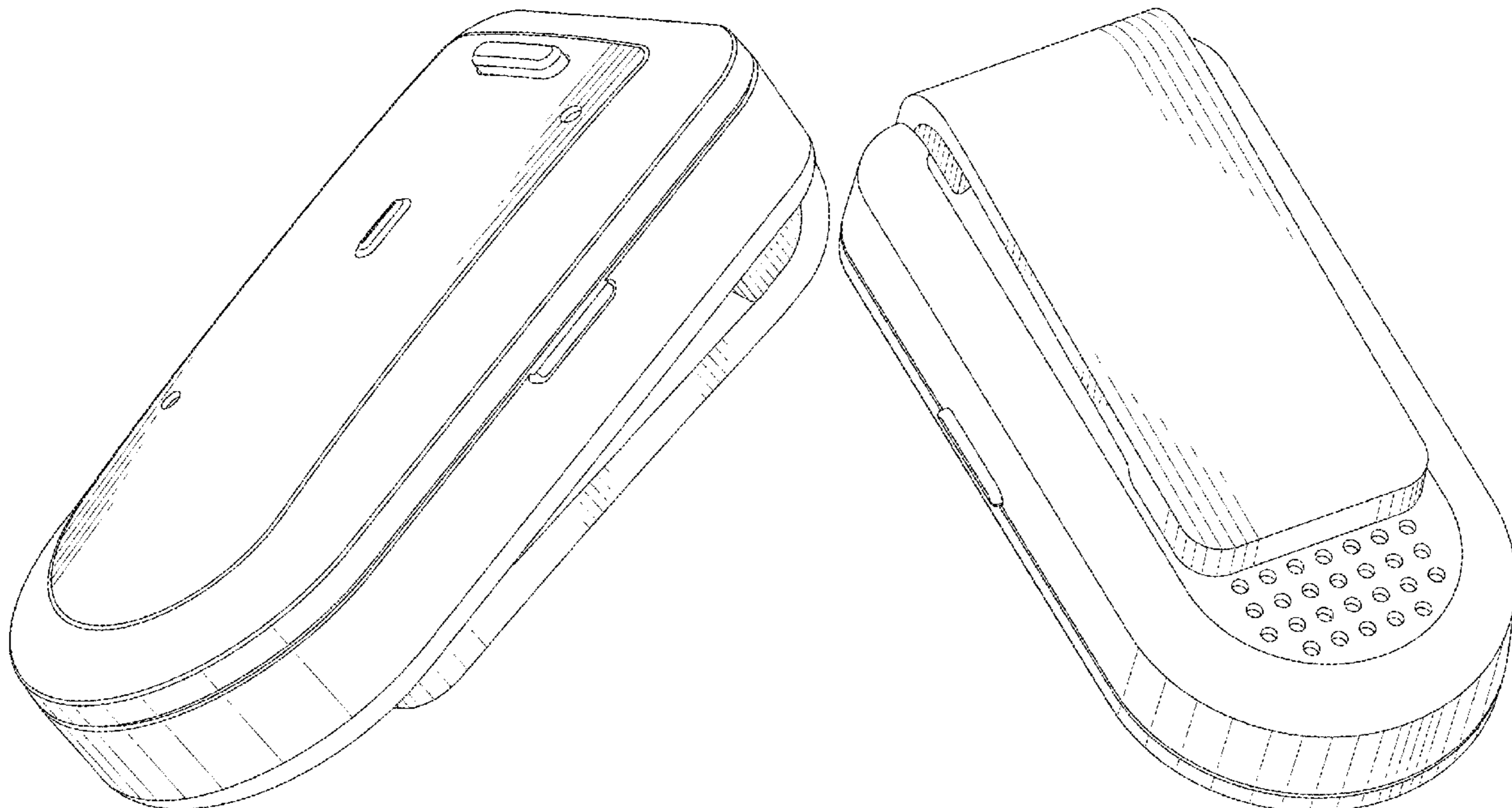

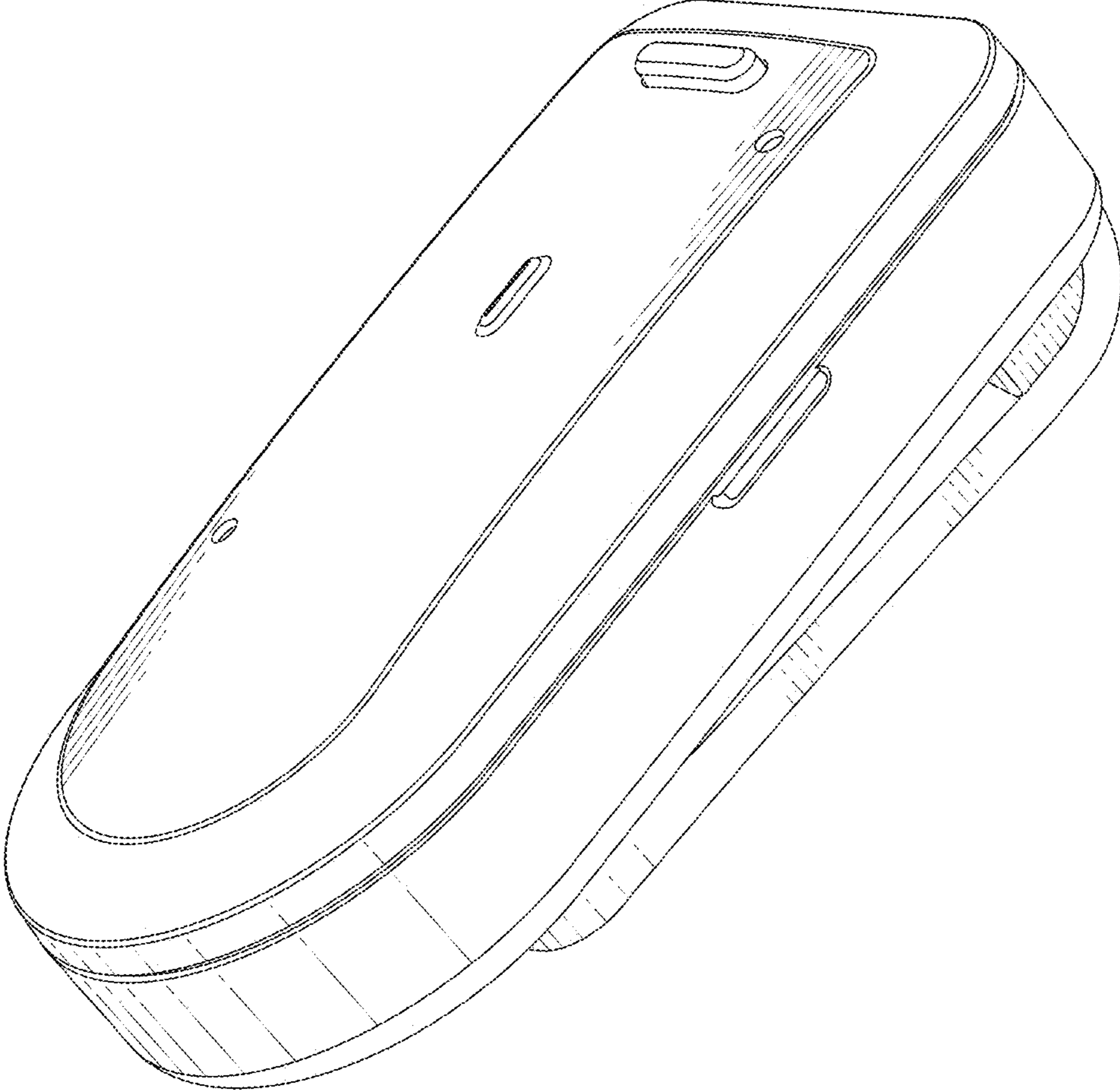

FIG. 1

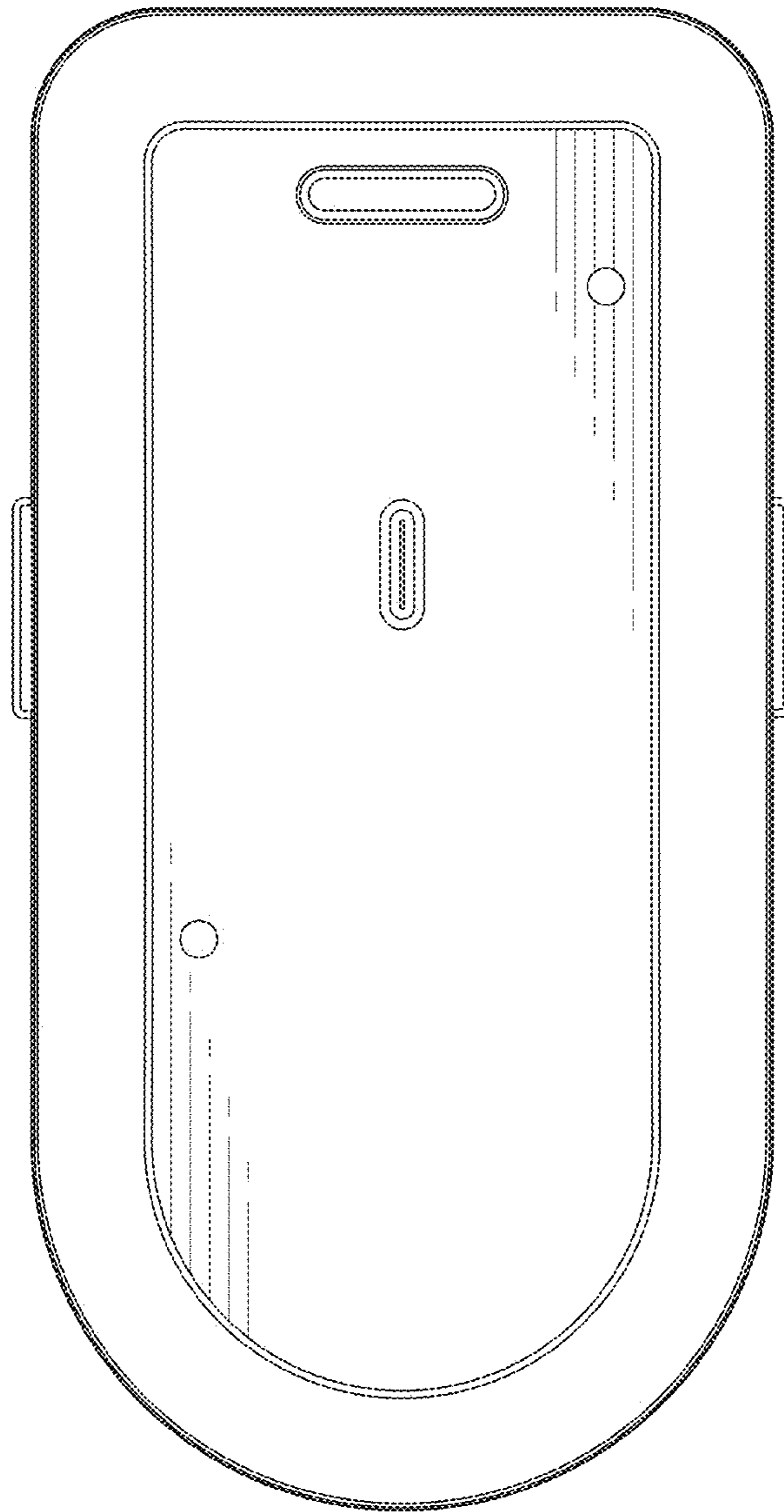

FIG. 2

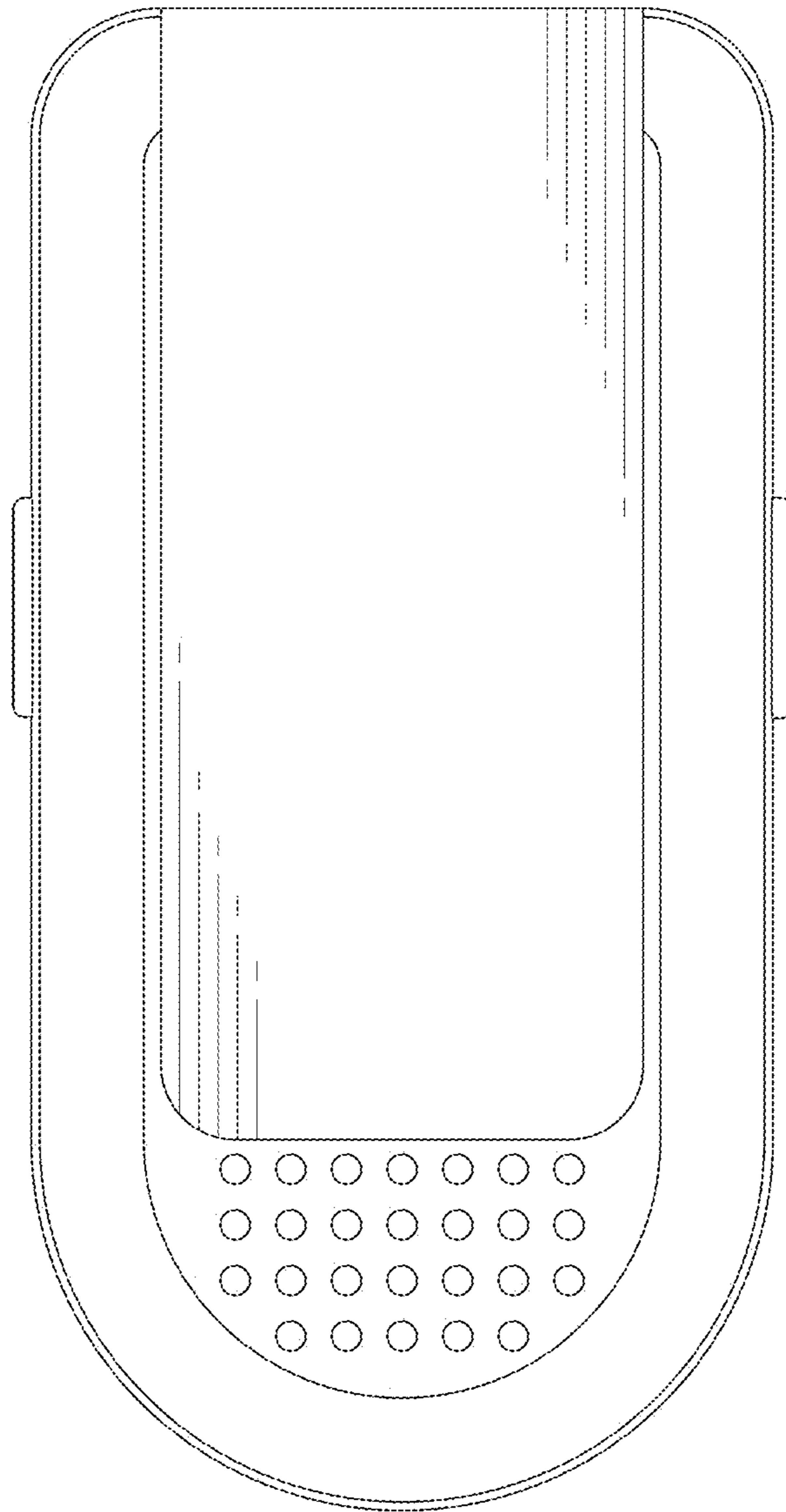

FIG. 3

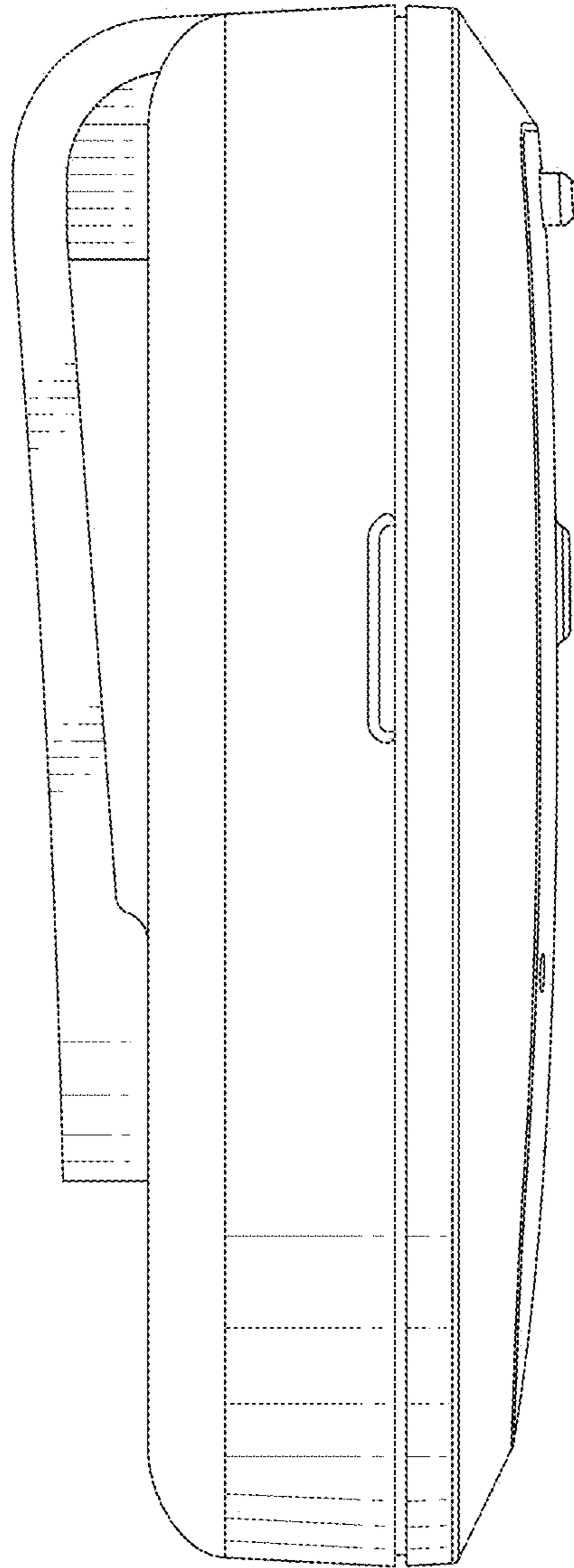

FIG. 4

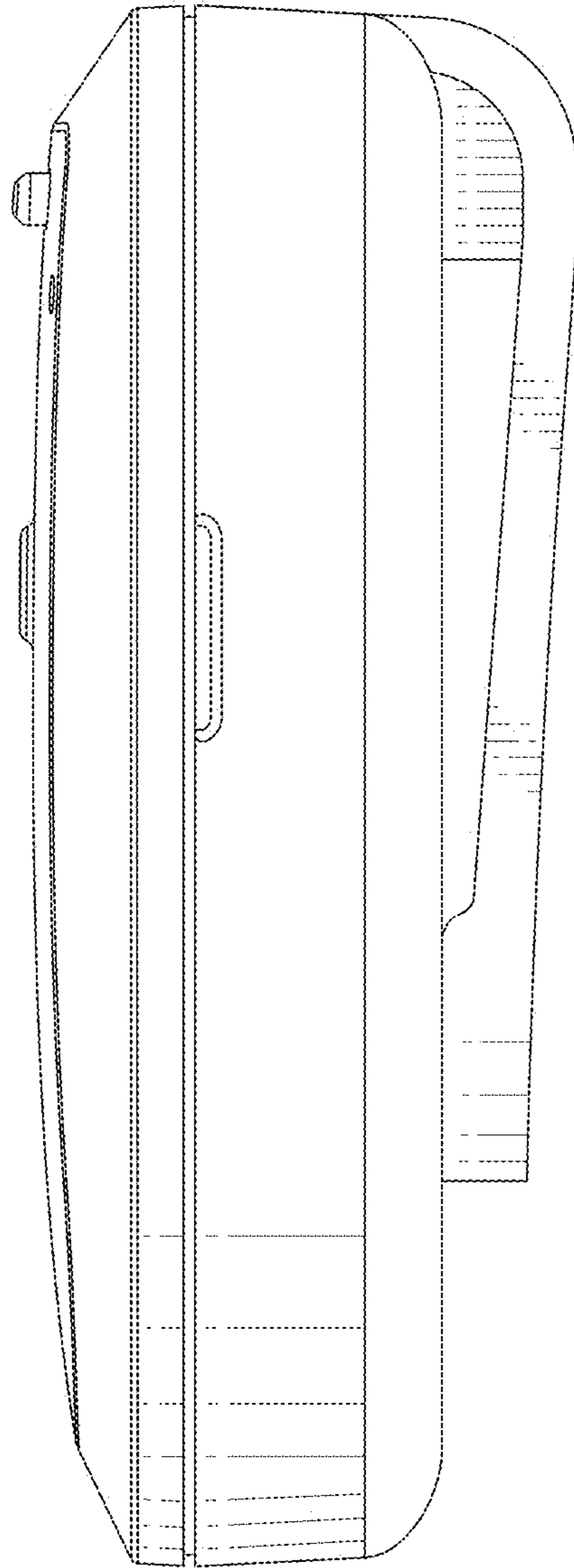

FIG. 5

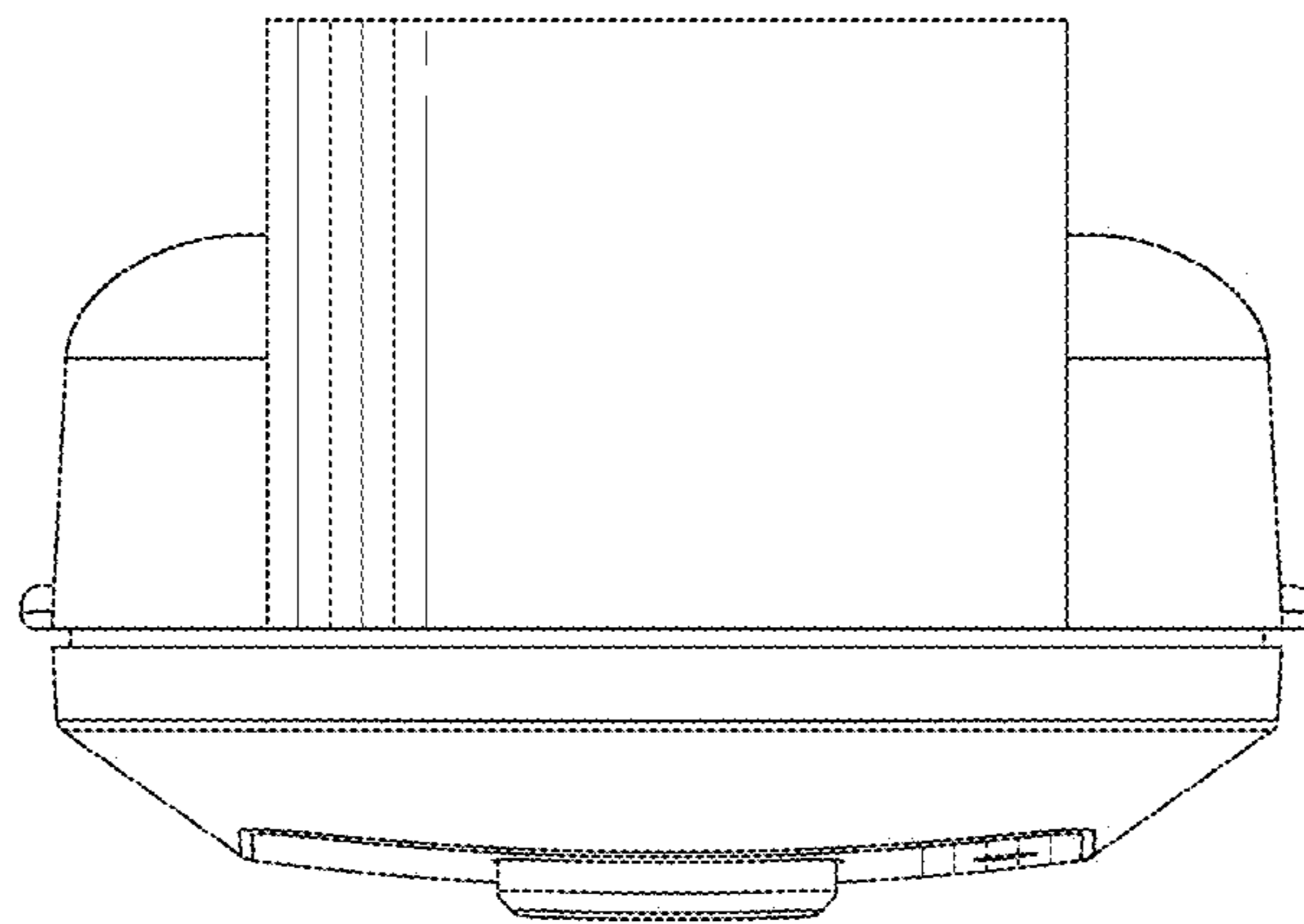

FIG. 6

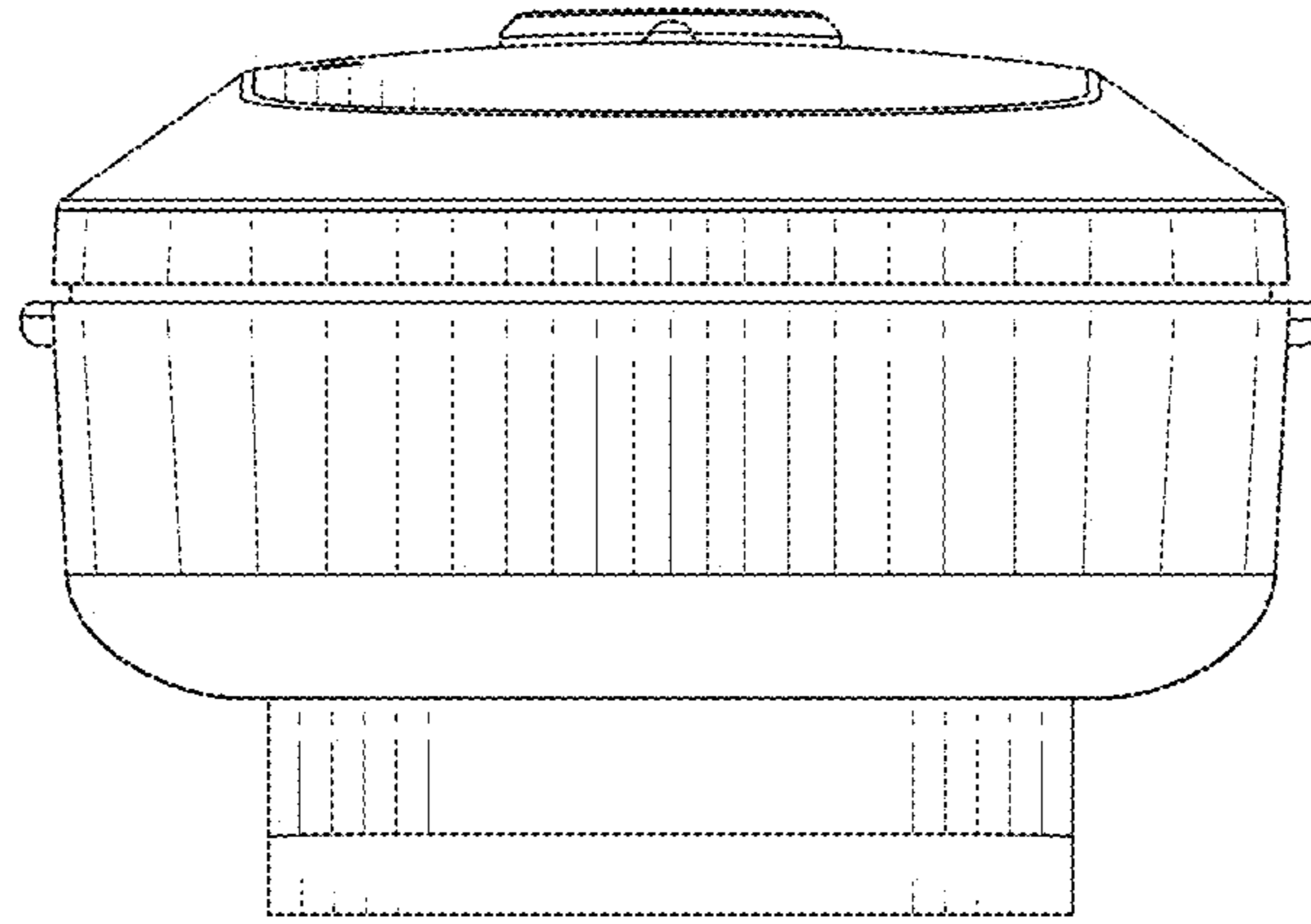

FIG. 7

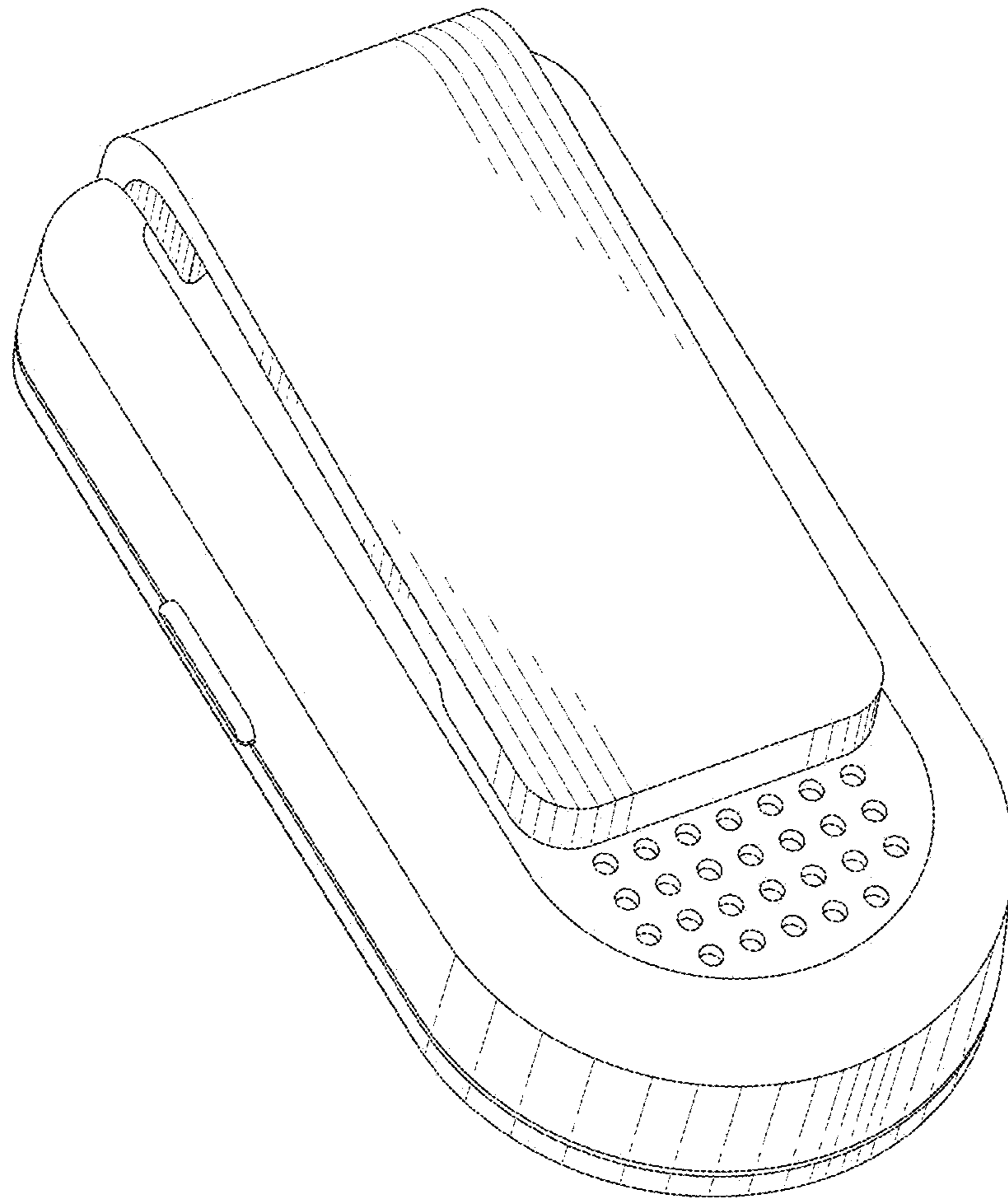

FIG. 8