



US00D896658S

(12) **United States Design Patent** (10) **Patent No.:** **US D896,658 S**
James (45) **Date of Patent:** **** *Sep. 22, 2020**

(54) **BOTTLE**

(71) Applicant: **Conopco, Inc.**, Englewood Cliffs, NJ (US)

(72) Inventor: **Addison Paris James**, Shanghai (CN)

(73) Assignee: **Conopco, Inc.**, Englewood Cliffs, NJ (US)

(*) Notice: This patent is subject to a terminal disclaimer.

(**) Term: **15 Years**

(21) Appl. No.: **29/616,248**

(22) Filed: **Sep. 5, 2017**

(30) **Foreign Application Priority Data**

Mar. 10, 2017 (EM) 003792613-0001

(51) **LOC (12) Cl.** **09-01**

(52) **U.S. Cl.**
USPC **D9/566**

(58) **Field of Classification Search**
USPC D7/300-322, 391-396.2, 509-511, 523, D7/589, 598, 612, 615, 619.1; D9/435, D9/436, 439, 440, 443, 447, 454, 500, D9/503-505, 516-575, 763-783; 215/40-55, 316-354, 370-385; 220/574-575; D4/116; D6/515, 516, D6/542-545; D28/7, 57, 73, 76-91.1
CPC B65D 1/00; B65D 1/02; B65D 1/0223; B65D 1/023; B65D 1/0276
See application file for complete search history.

(56) **References Cited**

U.S. PATENT DOCUMENTS

D43,507 S 2/1913 Nelson
D62,683 S * 7/1923 Weeks D9/771
D79,944 S * 11/1929 Teague D9/546

D80,708 S 3/1930 Teague
D80,917 S * 4/1930 Teague D9/566
D86,017 S 1/1932 Fuerst
D86,540 S * 3/1932 Piazzoli D9/546
D90,047 S * 5/1933 Popp D9/566
D94,153 S * 12/1934 Levine D9/573
D96,423 S * 7/1935 Smith D9/566
D98,958 S * 3/1936 Piazzoli D9/573
D100,372 S * 7/1936 Guerlain D9/544
D100,424 S * 7/1936 Guerlain D9/546

(Continued)

FOREIGN PATENT DOCUMENTS

CN 303529249 12/2015
VN K19960083 6/1997

OTHER PUBLICATIONS

National Industrial Design Application; Jun. 25, 1997; pp. 1-2 (Non-English original only).

(Continued)

Primary Examiner — Cathron C Brooks
Assistant Examiner — Christian P. McLean
(74) *Attorney, Agent, or Firm* — Foley & Lardner LLP

(57) **CLAIM**

The ornamental design for a bottle, as shown and described.

DESCRIPTION

FIG. 1 is a top perspective view of the claimed design; FIG. 2 is a front view thereof; FIG. 3 is a rear view thereof; FIG. 4 is a left side view thereof; FIG. 5 is a right side view thereof; FIG. 6 is a top view thereof; and, FIG. 7 is a bottom view thereof. Dot-dash-dot lines formed by dashes of alternating lengths show boundaries between claimed subject matter and non-claimed subject matter.

1 Claim, 5 Drawing Sheets

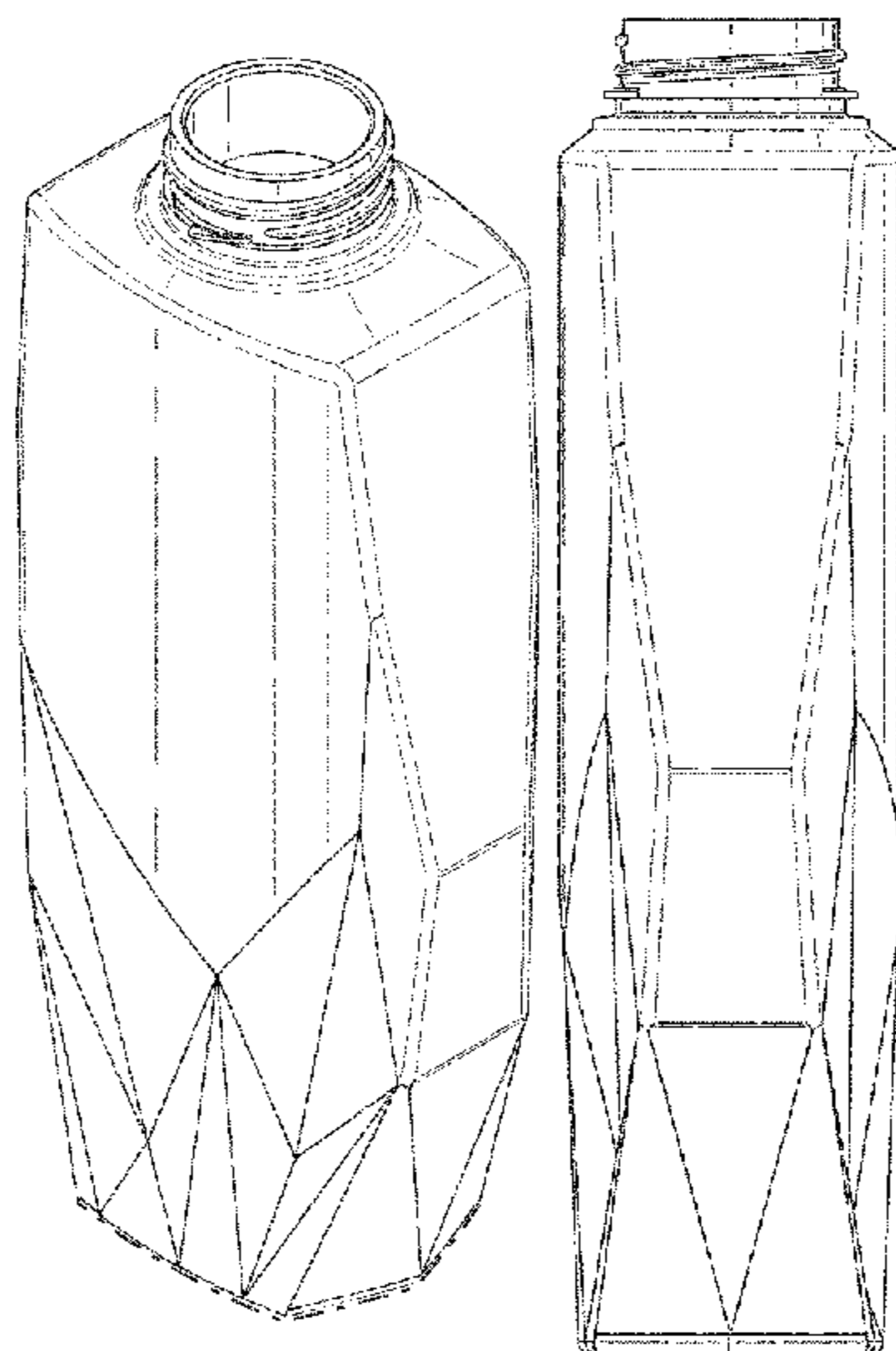

(56)

References Cited

U.S. PATENT DOCUMENTS

D115,343 S * 6/1939 Burgund D9/560
 D125,319 S 2/1941 Wangenheim
 D175,447 S 8/1955 Tucker
 D191,544 S 10/1961 Bloch
 D196,077 S 8/1963 Heintze
 D204,710 S 5/1966 Roberts
 D216,249 S 12/1969 Patrix
 D236,586 S 2/1975 McDonald
 D284,938 S 8/1986 Jedwab et al.
 D307,241 S 4/1990 Thompson
 D322,565 S 12/1991 Durand
 D328,247 S 7/1992 Robineau
 D355,128 S 2/1995 Samimi et al.
 D497,314 S 10/2004 Dea
 D530,620 S 10/2006 Owens et al.
 D531,044 S 10/2006 Owens et al.
 D531,045 S 10/2006 Owens et al.
 D531,515 S 11/2006 Owens et al.
 D533,072 S 12/2006 Kelly
 D544,361 S 6/2007 Cordes
 D545,212 S 6/2007 Kelly
 D595,583 S 7/2009 Lovelace, Jr. et al.
 D608,651 S * 1/2010 Eisen D9/435
 D622,613 S * 8/2010 Baron D9/550
 D626,422 S * 11/2010 Lloyd D9/435
 D644,111 S * 8/2011 Williams D9/550
 D644,112 S * 8/2011 Williams D9/550
 D644,113 S * 8/2011 Williams D9/550
 D646,981 S 10/2011 Flanagan-Kent et al.
 D650,688 S 12/2011 Simmons
 D694,640 S 12/2013 Infahsaeng et al.
 D715,152 S 10/2014 Maskell et al.
 D726,967 S 4/2015 Komai et al.
 D734,160 S 7/2015 Aranda
 D747,972 S 1/2016 Allan

D748,490 S 2/2016 Allan
 D750,496 S * 3/2016 Cutler D9/538
 D774,833 S 12/2016 Likar
 D781,713 S 3/2017 Papernik
 D790,924 S * 7/2017 Hume D7/523
 D790,975 S 7/2017 Allan
 D809,925 S 2/2018 Cossu
 D810,580 S * 2/2018 Staab D9/682
 D826,724 S 8/2018 Staab et al.
 D832,532 S * 10/2018 Geller D30/160
 D833,290 S * 11/2018 Byron D9/559
 D850,272 S * 6/2019 Wanders D9/529
 D852,055 S * 6/2019 Goulet Dubois D9/651
 D852,635 S * 7/2019 Dammers D9/566
 D852,638 S * 7/2019 Ericson D9/686
 D856,149 S * 8/2019 Orofino D9/529
 D856,810 S * 8/2019 James D9/566
 D856,811 S * 8/2019 James D9/566
 D856,812 S * 8/2019 James D9/566
 D859,999 S * 9/2019 Mendelson D9/694
 D867,154 S * 11/2019 Sanghavi D9/560
 D876,016 S * 2/2020 Hosseini D28/76
 D879,615 S * 3/2020 Young D9/542

OTHER PUBLICATIONS

Salon Deapres Bottle Design, Salon Deapres (Japan) Bottle Design, before Feb. 7, 2014, pp. 1-4.
 Co-Pending U.S. Appl. No. 29/616,251; Applicant: Addison Paris James, filed Sep. 5, 2017.
 Co-Pending U.S. Appl. No. 29/616,253; Applicant: Addison Paris James, filed Sep. 5, 2017.
 Co-Pending U.S. Appl. No. 29/616,256; Applicant: Addison Paris James, filed Sep. 5, 2017.
 Cocovel bottle; E-Commerce; before Oct. 2017; p. 1.

* cited by examiner

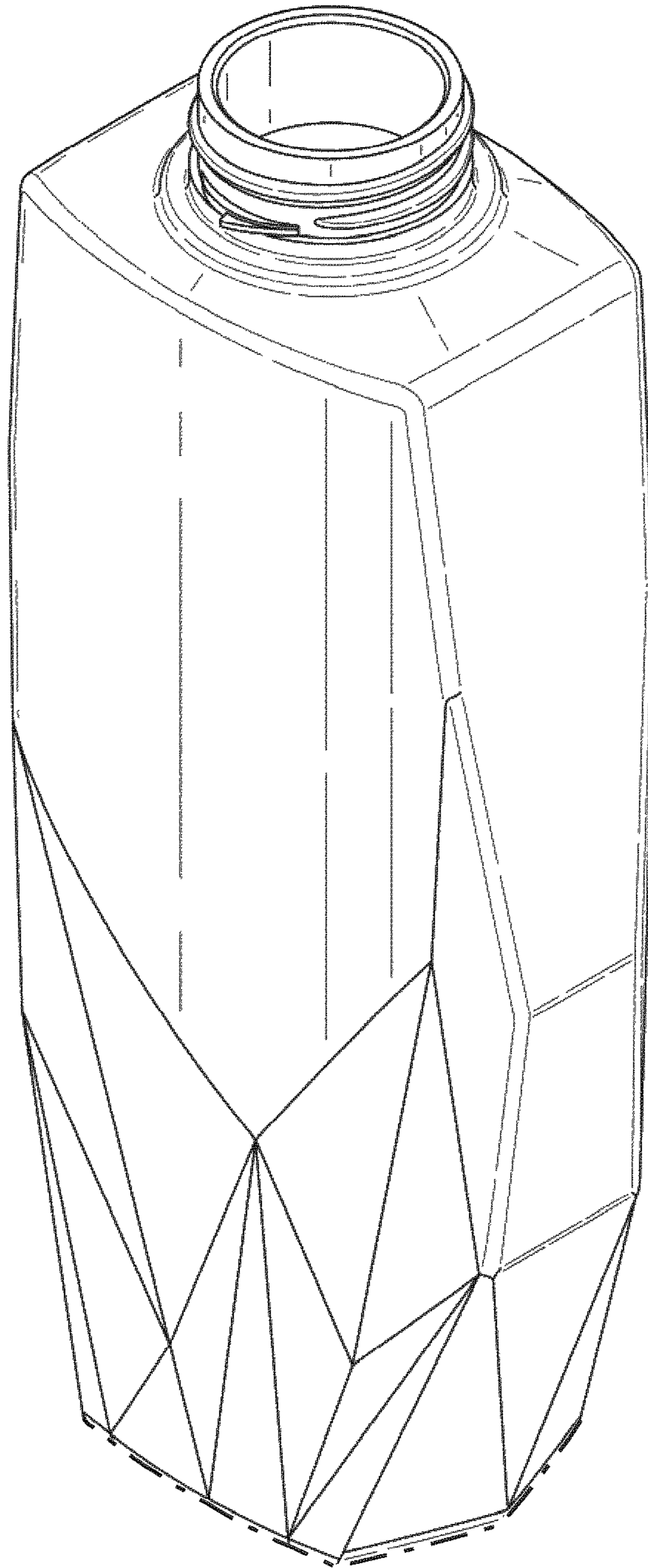

Fig. 1

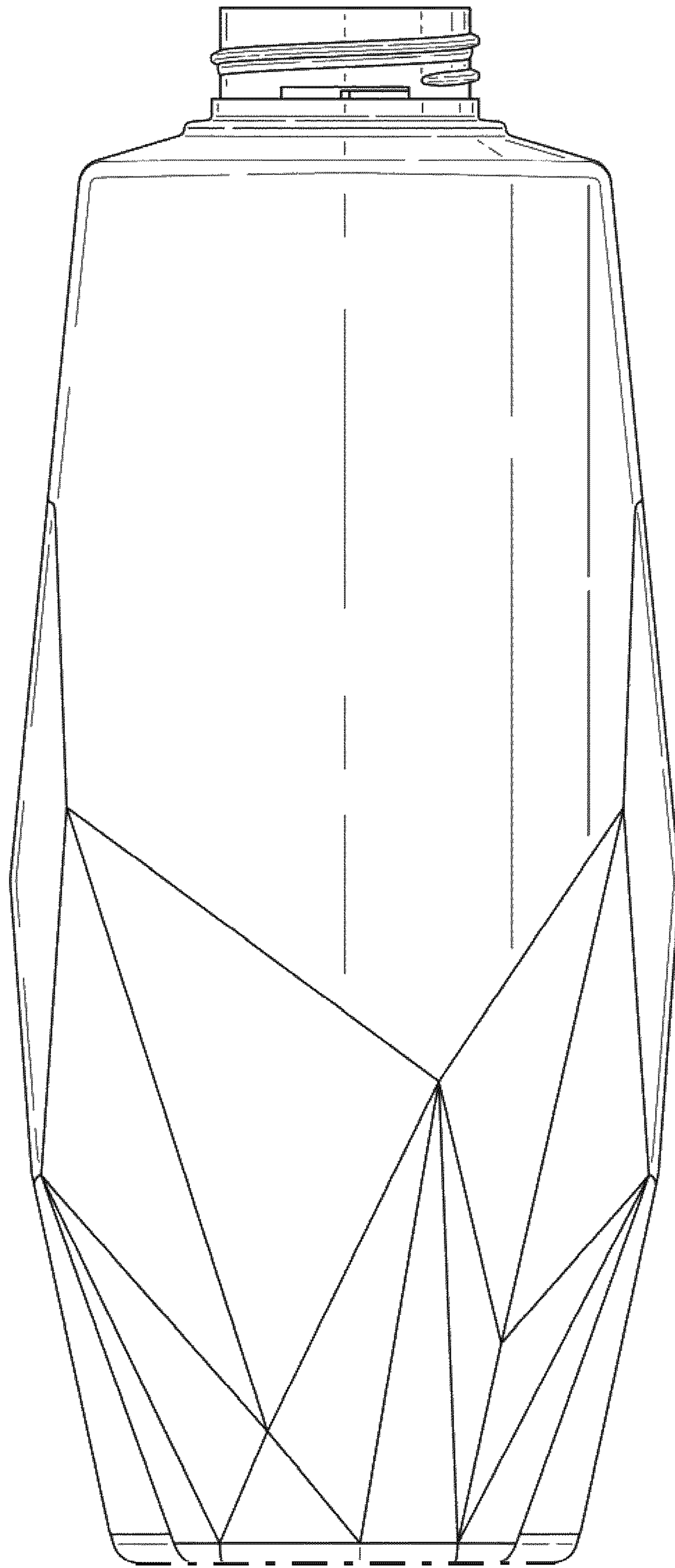

Fig. 2

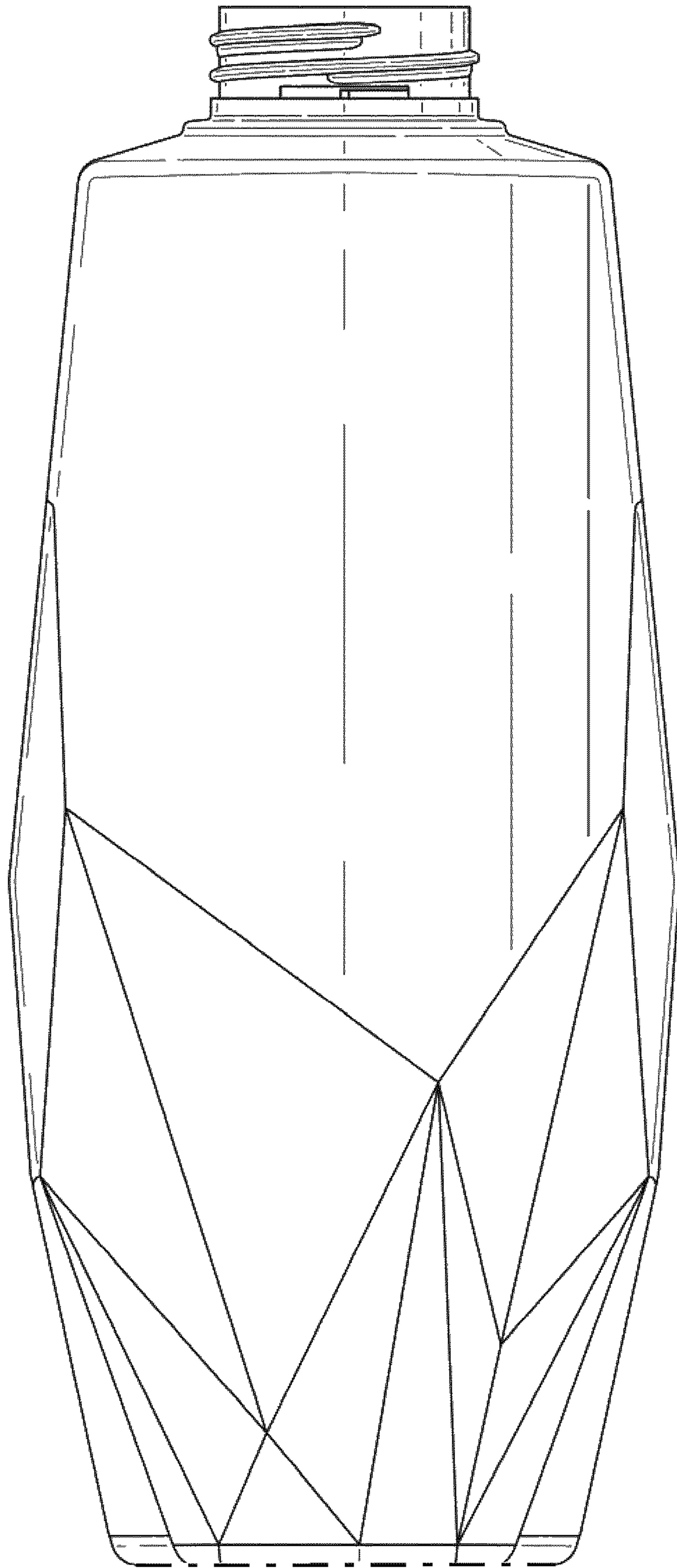

Fig. 3

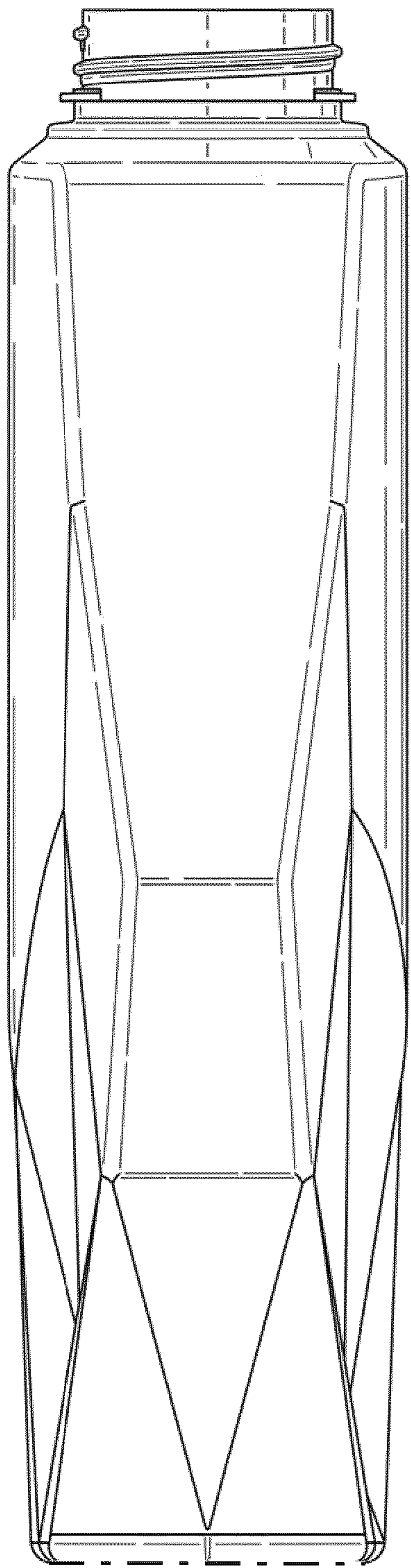

Fig. 4

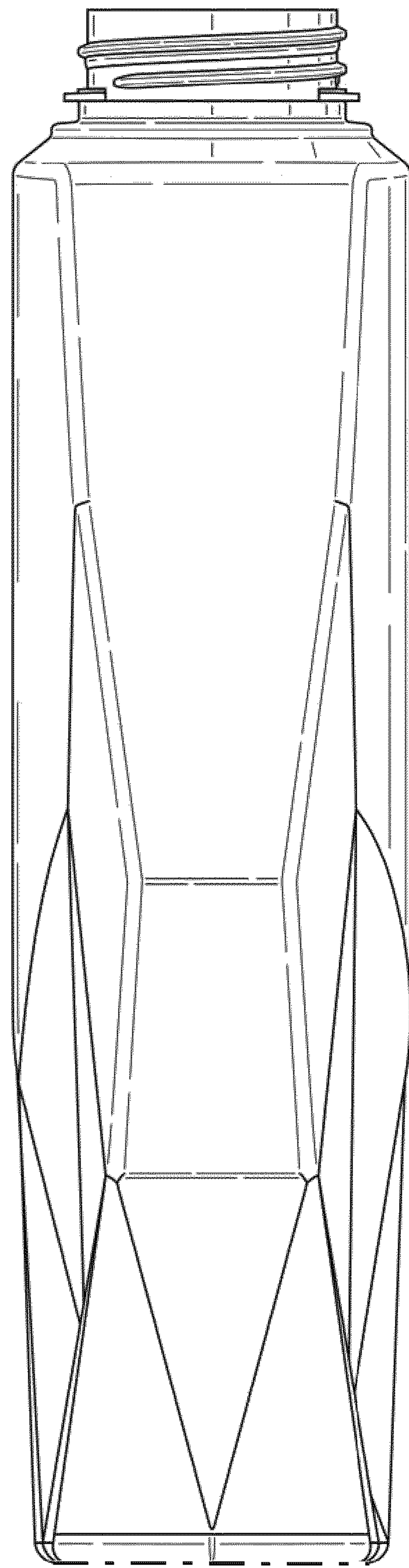

Fig. 5

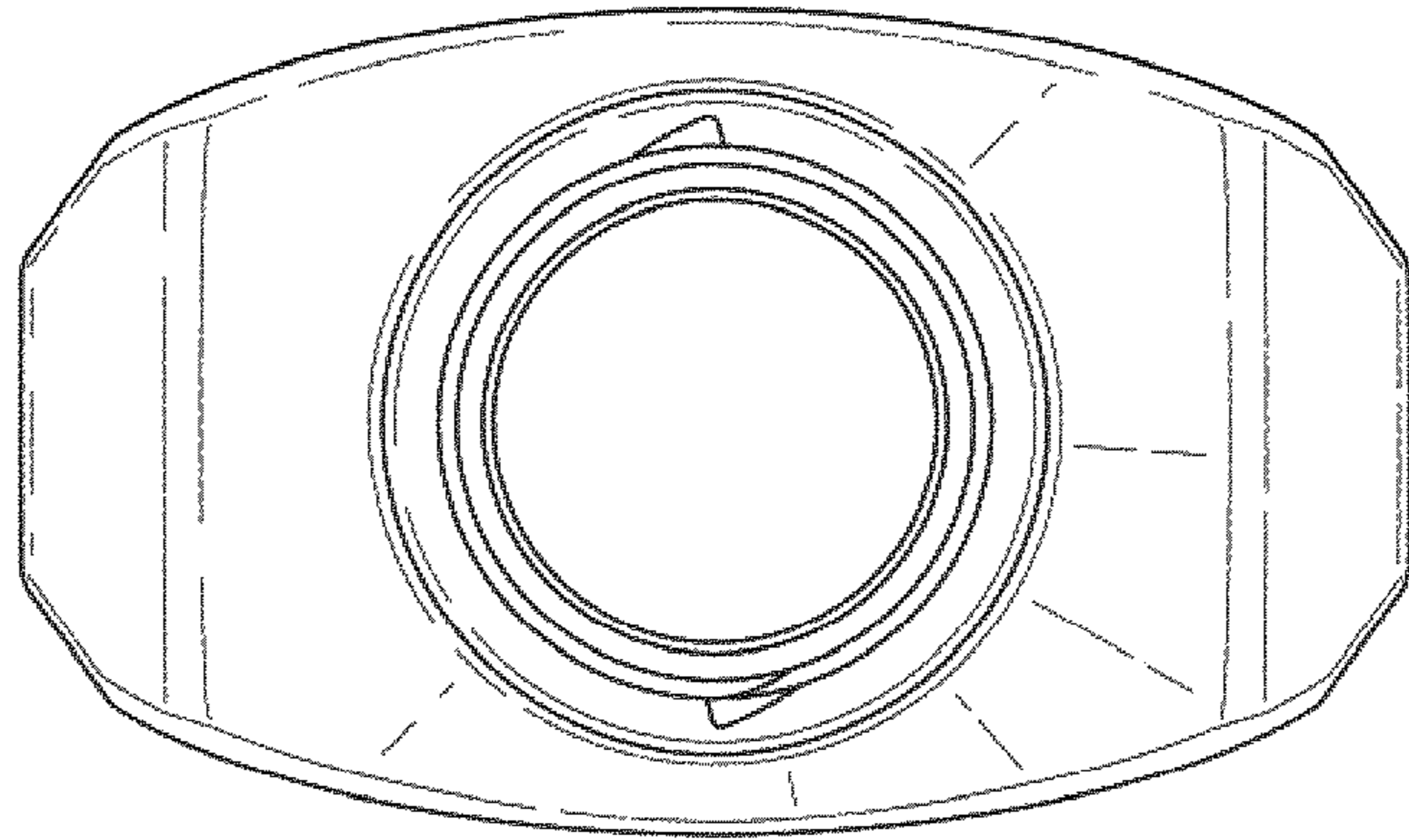

Fig. 6

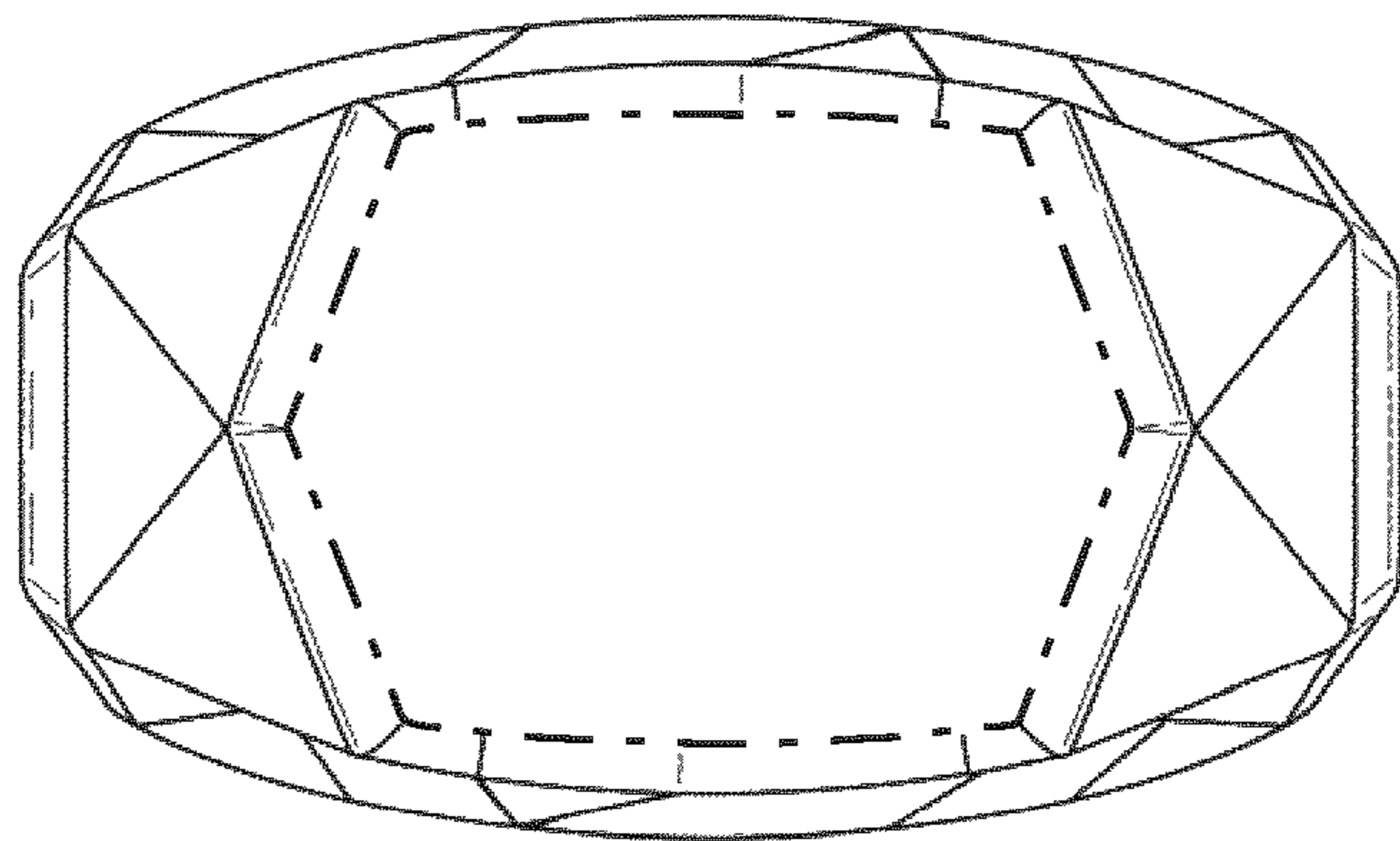

Fig. 7