

US00D896633S

(12) **United States Design Patent** (10) **Patent No.:** **US D896,633 S**
Balzer et al. (45) **Date of Patent:** **** *Sep. 22, 2020**

(54) **CONTAINER**
(71) Applicant: **GOLDEN STATE FOODS CORP.**,
Irvine, CA (US)
(72) Inventors: **Larry Balzer**, Waterford, WI (US);
Linda Balzer, Waterford, WI (US);
Drew Chrisohon, Statham, GA (US);
Dan Wenker, Atlanta, GA (US)
(73) Assignee: **GOLDEN STATE FOODS CORP.**,
Irvine, CA (US)
(*) Notice: This patent is subject to a terminal dis-
claimer.
(**) Term: **15 Years**

5,529,224 A 6/1996 Chan et al.
D372,169 S 7/1996 Newman
5,779,050 A 7/1998 Kocher et al.
5,839,609 A 11/1998 Zakensberg
5,842,324 A 12/1998 Grosskopf et al.
5,875,914 A 3/1999 Nguyen et al.
5,882,117 A 3/1999 Laffon
5,904,263 A 5/1999 St. Pierre et al.
5,927,498 A 7/1999 Saam
5,934,809 A 8/1999 Marbler
5,944,188 A 8/1999 Grosskopf et al.
5,954,433 A 9/1999 Yeager
5,964,534 A 10/1999 Welles
5,996,780 A 12/1999 Gurrera
5,996,845 A 12/1999 Chan
6,073,767 A 6/2000 Cohen et al.
D436,857 S 1/2001 Griffin et al.

(Continued)

(21) Appl. No.: **29/678,516**
(22) Filed: **Jan. 29, 2019**
(51) **LOC (12) Cl.** **09-03**
(52) **U.S. Cl.**
USPC **D9/425**
(58) **Field of Classification Search**
USPC D7/400, 601, 608; D9/416, 417, 420,
D9/425-429, 430, 432, 761; 206/499,
206/501, 502, 821; 220/625, 656, 669,
220/670, 674; 229/123.1, 123.2, 125.33,
229/125.35, 400-407, 915, 939
CPC . B65D 1/26; B65D 1/40; B65D 5/243; B65D
81/3453; B65D 2581/34; B65D
2581/3404; B65D 2581/3456
See application file for complete search history.

FOREIGN PATENT DOCUMENTS

WO 9840287 A1 9/1998
WO 2013134280 A1 9/2013

(Continued)

Primary Examiner — Janice Patyk
(74) *Attorney, Agent, or Firm* — BakerHostetler

(57) **CLAIM**

The ornamental design for a container, as shown and described.

DESCRIPTION

FIG. 1 is a top perspective view of a container, showing our new design.
FIG. 2 is a bottom perspective view of the container.
FIG. 3 is a top plan view of the container.
FIG. 4 is a bottom plan view of the container.
FIG. 5 is a left side view of the container.
FIG. 6 is a right side view of the container.
FIG. 7 is a front view of the container; and,
FIG. 8 is a rear view of the container.

1 Claim, 8 Drawing Sheets

(56) **References Cited**
U.S. PATENT DOCUMENTS
D304,679 S 11/1989 Corella
D318,611 S 7/1991 Sherman
5,411,178 A 5/1995 Roders et al.
D369,212 S 4/1996 Snell

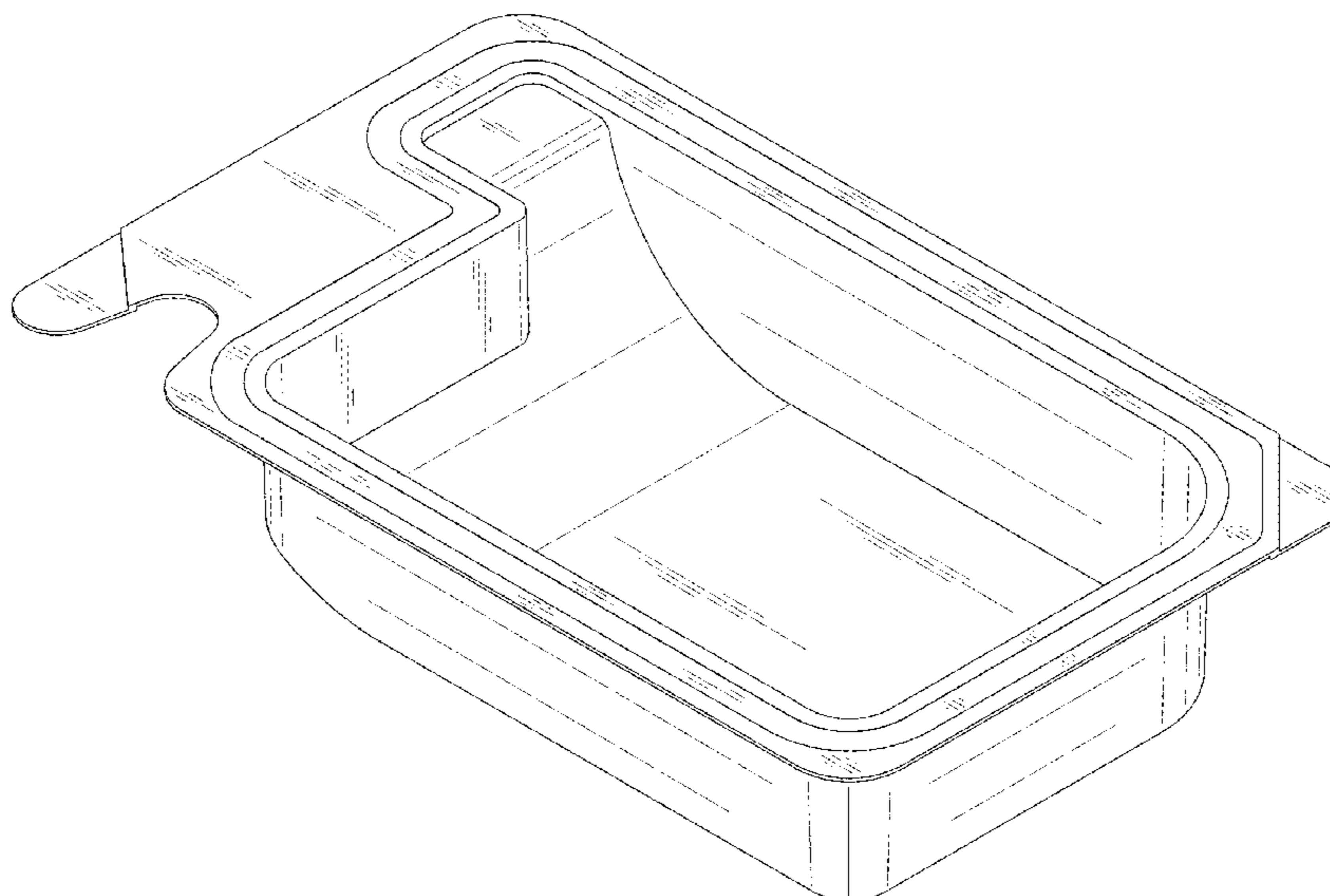

(56)

References Cited

U.S. PATENT DOCUMENTS

6,173,554 B1	1/2001	Marbler	7,261,468 B2	8/2007	Schneider et al.
6,174,083 B1	1/2001	Delefortrie et al.	D553,007 S	10/2007	Goodwin et al.
6,206,571 B1	3/2001	Olin	D553,974 S	10/2007	Croft et al.
6,224,262 B1	5/2001	Hogan et al.	D556,564 S *	12/2007	Lee D9/415
6,244,747 B1	6/2001	Caudle	D561,580 S	2/2008	Croft et al.
6,250,468 B1	6/2001	Huchel	D561,581 S	2/2008	Croft et al.
D445,674 S	7/2001	Pritchett	7,331,716 B2	2/2008	Nakano et al.
6,283,336 B1	9/2001	Dwyer et al.	7,361,872 B2	4/2008	Cole
6,293,073 B1	9/2001	Caudle	7,364,779 B2	4/2008	Nomula
6,293,394 B1	9/2001	Marbler et al.	7,371,008 B2	5/2008	Bonenfant
6,299,012 B1	10/2001	Redmond	7,374,039 B2	5/2008	Farmer
6,309,104 B1	10/2001	Koch et al.	7,458,741 B2	12/2008	Detwiler et al.
6,326,069 B1	12/2001	Barnett et al.	D584,141 S	1/2009	Smith et al.
6,332,726 B2	12/2001	Yamamoto et al.	D585,762 S	2/2009	Friedland et al.
D452,817 S	1/2002	Berman	D594,752 S	6/2009	Medema et al.
D452,818 S	1/2002	Berman	7,573,010 B2	8/2009	Cole
D452,819 S	1/2002	Berman	7,585,528 B2	9/2009	Ferri et al.
D453,001 S	1/2002	Berman	7,604,155 B2	10/2009	Bossel et al.
6,349,823 B1	2/2002	Innis	7,604,828 B2	10/2009	Taylor et al.
6,352,364 B1	3/2002	Mobs	7,607,834 B2	10/2009	Alvater et al.
6,352,365 B1	3/2002	Healy et al.	D606,882 S	12/2009	Sharp et al.
6,360,477 B1	3/2002	Flashinski et al.	7,624,872 B2	12/2009	Elliott
6,360,916 B1	3/2002	Sokolsky et al.	7,637,449 B1	12/2009	Leyshon et al.
6,364,519 B1	4/2002	Hughes et al.	7,658,542 B2	2/2010	Risgalla
D459,222 S	6/2002	Mello et al.	7,669,714 B1	3/2010	Grossman
6,402,379 B1	6/2002	Albright	D614,023 S	4/2010	Amos et al.
6,427,420 B1	8/2002	Olivieri et al.	7,703,619 B2	4/2010	Van Puijenbroek
D463,265 S	9/2002	Jones	7,744,517 B2	6/2010	Bonenfant
D463,266 S	9/2002	Zappa	7,757,859 B1	7/2010	Grossman
D463,275 S	9/2002	Garcia	7,758,484 B2	7/2010	Peterson
D463,738 S	10/2002	Jones	7,762,421 B2	7/2010	Fujimura
D463,974 S	10/2002	Berman	D623,072 S	9/2010	Caldwell et al.
6,467,621 B1	10/2002	Ishida	D627,236 S	11/2010	Kozarsky
D466,002 S	11/2002	Jones	D628,902 S	12/2010	Schroeder et al.
6,502,693 B1	1/2003	Percival	7,866,886 B2	1/2011	Kurosawa et al.
D469,685 S	2/2003	Dennis et al.	D632,564 S	2/2011	Caldwell et al.
D471,090 S	3/2003	Jones	D632,565 S	2/2011	Caldwell et al.
D473,132 S	4/2003	Berman	D632,566 S	2/2011	Caldwell et al.
6,568,533 B1	5/2003	Tanaka et al.	D632,567 S	2/2011	Caldwell et al.
D475,915 S	6/2003	Lawrie et al.	D632,568 S	2/2011	Caldwell et al.
6,609,613 B2	8/2003	Schneider et al.	D632,587 S	2/2011	Richmond
6,610,338 B2	8/2003	Tang	7,883,268 B2	2/2011	Steele
6,641,307 B2	11/2003	Matsuda et al.	7,891,875 B1	2/2011	Feldman
6,655,837 B2	12/2003	Matsuda et al.	D634,643 S *	3/2011	Caldwell D9/707
6,691,886 B1	2/2004	Bemdt et al.	7,950,851 B2	5/2011	Taheri
6,715,919 B2	4/2004	Hiraiwa et al.	7,967,510 B2	6/2011	Martuch
6,726,054 B2	4/2004	Fagen et al.	D641,642 S	7/2011	Caldwell et al.
6,739,113 B1	5/2004	Kocher et al.	7,971,717 B2	7/2011	Eilert et al.
6,777,050 B1	8/2004	Engelaere	7,984,807 B2	7/2011	Elliott
6,814,230 B2	11/2004	Innis	7,992,716 B2	8/2011	Jackson
6,857,779 B2	2/2005	Olin	8,021,049 B2	9/2011	Smith
6,880,973 B2	4/2005	Schneider et al.	8,070,016 B2	12/2011	Kawakami et al.
6,902,335 B2	6/2005	Bergey et al.	8,109,387 B2	2/2012	Sogaro
6,910,995 B2	6/2005	Schneider et al.	D655,154 S	3/2012	Amos et al.
6,929,128 B2	8/2005	Caldwell et al.	D655,201 S	3/2012	Schuch
6,935,783 B2	8/2005	Carter	8,141,709 B2	3/2012	Klaus
D509,751 S	9/2005	Risgalla	D658,055 S	4/2012	Kurita et al.
D510,263 S	10/2005	Isono et al.	8,147,934 B2	4/2012	Berbert
D511,680 S	11/2005	Zaborski	8,157,095 B2	4/2012	Motsch
6,964,520 B1	11/2005	Sakai et al.	D660,142 S	5/2012	Kirk et al.
D512,648 S	12/2005	Smith et al.	D660,718 S	5/2012	McDermott et al.
7,018,099 B2	3/2006	Caudle	8,173,233 B2	5/2012	Rogers et al.
7,036,986 B2	5/2006	Matsuda et al.	8,178,822 B2	5/2012	Cole
7,073,692 B2	7/2006	Weyts	D662,833 S	7/2012	Sanfilippo et al.
D527,273 S	8/2006	Edwards	D663,631 S	7/2012	McDermott et al.
7,086,528 B2	8/2006	Raia et al.	8,220,651 B2	7/2012	Norcom
7,100,802 B2	9/2006	Sogaro	8,230,664 B2	7/2012	Prizzi et al.
7,104,419 B2	9/2006	Fagen et al.	8,231,026 B2	7/2012	White
7,112,305 B2	9/2006	McEntee et al.	8,247,057 B2	8/2012	Velasquez Urey et al.
D529,396 S	10/2006	Whipple	8,251,217 B2	8/2012	Hemmerlin et al.
D530,626 S	10/2006	Tanja	8,256,636 B2	9/2012	Huffer
7,166,258 B2	1/2007	Bass et al.	D669,367 S	10/2012	McDermott et al.
D539,134 S *	3/2007	Wallach D9/416	8,292,076 B2	10/2012	Dacey
D545,689 S	7/2007	Peel	D670,573 S	11/2012	McDermott et al.
7,240,797 B1	7/2007	Grossman	8,333,510 B2	12/2012	Ackermann et al.
			D674,707 S	1/2013	Berman
			D676,334 S	2/2013	McDermott et al.
			8,393,815 B2	3/2013	Crucs
			8,397,914 B1	3/2013	Janichek, Jr. et al.

(56)

References Cited

U.S. PATENT DOCUMENTS

8,403,161 B2	3/2013	Van Puijenbroek	2002/0184857 A1	12/2002	O'Connor et al.
8,403,581 B2	3/2013	Crucs	2003/0002755 A1	1/2003	Kim et al.
8,408,793 B2	4/2013	Martuch	2003/0019780 A1	1/2003	Parodi et al.
8,418,883 B2	4/2013	Sharp et al.	2003/0026875 A1	2/2003	Aguilar et al.
D682,084 S	5/2013	Pierre et al.	2003/0026876 A1	2/2003	Albuja et al.
D682,710 S	5/2013	McDermott et al.	2003/0118254 A1	6/2003	Razeti et al.
D684,456 S	6/2013	Bakker et al.	2003/0128899 A1	7/2003	Dennis
D684,481 S	6/2013	Campos	2003/0183637 A1	10/2003	Zappa et al.
D687,720 S	8/2013	Guerra	2003/0192893 A1	10/2003	Weder
8,544,687 B2	10/2013	Sharp et al.	2003/0230604 A1	12/2003	Huffer
8,550,093 B2	10/2013	Saint-Girons et al.	2004/0031823 A1	2/2004	Redmond
8,551,545 B2	10/2013	Feldmeier et al.	2004/0052437 A1	3/2004	Tobolka
8,590,282 B2	11/2013	Perell et al.	2004/0079763 A1	4/2004	Powell et al.
D695,132 S	12/2013	Bouthillon	2004/0131286 A1	7/2004	Rosen
8,613,548 B2	12/2013	Murray	2004/0136623 A1	7/2004	Obara
8,616,374 B2	12/2013	Hemmerlin	2004/0140240 A1	7/2004	Ricotti
8,616,375 B2 *	12/2013	Welch B65D 65/46 206/524.7	2004/0141664 A1	7/2004	Olsen et al.
8,622,206 B2	1/2014	Miller et al.	2004/0228549 A1	11/2004	Wu
8,622,619 B2	1/2014	Adams et al.	2004/0247210 A1	12/2004	Alvarez
8,684,217 B2	4/2014	Bruehl et al.	2004/0252920 A1	12/2004	Moteki et al.
8,690,431 B2	4/2014	Hughes	2005/0031232 A1	2/2005	Jammet et al.
8,727,156 B2	5/2014	Skwarek et al.	2005/0061701 A1	3/2005	Osgood
8,740,003 B2	6/2014	Elliott	2005/0063624 A1	3/2005	Goto et al.
8,746,490 B2	6/2014	Huffer et al.	2005/0079251 A1	4/2005	Bell
8,807,373 B1	8/2014	Russell	2005/0150891 A1	7/2005	Schalk et al.
8,870,055 B2	10/2014	Backman	2005/0207821 A1	9/2005	Bergey et al.
8,876,383 B2	11/2014	Doll et al.	2005/0281495 A1	12/2005	Recchia
8,910,828 B2	12/2014	Kanderka et al.	2006/0042986 A1 *	3/2006	Simkowski B65D 75/366 206/470
8,919,594 B2	12/2014	Teys	2006/0062497 A1	3/2006	Murray
D722,890 S	2/2015	Bell	2006/0110081 A1	5/2006	Chapougnot et al.
D723,365 S *	3/2015	Mitchell D9/416	2006/0113305 A1	6/2006	Ferrazzi
9,061,796 B2	6/2015	Caldwell et al.	2006/0124652 A1	6/2006	Ohtsuki et al.
9,061,819 B2	6/2015	Kane, Jr. et al.	2006/0165927 A1	7/2006	Harano et al.
9,145,248 B2	9/2015	Krumme	2006/0275530 A1	12/2006	Rommo
D743,272 S	11/2015	Rasgon	2007/0017929 A1	1/2007	Bracht
9,238,538 B2	1/2016	Sagel	2007/0062844 A1	3/2007	Velasquez Urey et al.
9,260,226 B2	2/2016	Bouline et al.	2007/0068945 A1	3/2007	Bykowski et al.
9,260,231 B2	2/2016	Havrileck et al.	2007/0068965 A1	3/2007	Von Flotow et al.
9,309,036 B2	4/2016	Steele et al.	2007/0071854 A1	3/2007	Dowd et al.
D758,180 S *	6/2016	Wintolders D9/415	2007/0081745 A1	4/2007	Tetenborg et al.
9,376,249 B2	6/2016	Steele et al.	2007/0110344 A1	5/2007	Murray
9,382,053 B2	7/2016	Doll et al.	2007/0122067 A1	5/2007	Redmond
9,399,542 B1	7/2016	Davison	2007/0175920 A1	8/2007	Takada et al.
D763,101 S	8/2016	Wilson	2007/0177828 A1	8/2007	Takada et al.
D764,906 S *	8/2016	Lee D9/425	2007/0189835 A1	8/2007	Klocke et al.
D764,944 S	8/2016	Timm	2007/0228073 A1	10/2007	Mazzarino
D766,728 S	9/2016	Seneca	2007/0269146 A1	11/2007	Jeannin
D766,735 S	9/2016	Ackerman et al.	2007/0274615 A1	11/2007	Deniaud et al.
9,434,522 B2	9/2016	Leiner et al.	2008/0000925 A1	1/2008	Fuisz et al.
D768,505 S	10/2016	Meek et al.	2008/0031555 A1	2/2008	Roberts
9,463,896 B2	10/2016	Fitzwater	2008/0038415 A1	2/2008	Obermann
9,469,423 B2	10/2016	Thomas, Jr. et al.	2008/0063324 A1	3/2008	Bernard et al.
9,586,727 B2	3/2017	Nathan	2008/0095477 A1	4/2008	Hagino
9,597,852 B2	3/2017	Krumme	2008/0131035 A1	6/2008	Rogers
9,611,069 B2	4/2017	Rhue	2008/0138000 A1	6/2008	Miller et al.
9,617,024 B2	4/2017	Sharp et al.	2008/0164288 A1	7/2008	Singleton
9,637,293 B2	5/2017	Krumme et al.	2008/0181539 A1	7/2008	Marco
9,649,472 B2	5/2017	Keams et al.	2008/0253696 A1	10/2008	Haas et al.
9,656,783 B2	5/2017	Lyzenga et al.	2008/0273821 A1	11/2008	Doll
9,669,981 B2	6/2017	Bazbaz	2008/0274239 A1	11/2008	Doll
9,708,104 B2	7/2017	Lyzenga et al.	2008/0277459 A1	11/2008	Lenoir
9,718,593 B2	8/2017	Gillespie	2008/0302678 A1	12/2008	Hunwisk et al.
D799,336 S	10/2017	Sahatjian	2009/0003735 A1	1/2009	Michalsky et al.
D799,982 S	10/2017	Wells	2009/0003739 A1	1/2009	Yoshida
9,776,782 B2	10/2017	Klipstine	2009/0014455 A1	1/2009	Ferrazzi et al.
9,783,354 B2	10/2017	Rhue	2009/0014491 A1	1/2009	Fuisz et al.
9,796,512 B2	10/2017	Bouline et al.	2009/0020559 A1	1/2009	Sanfilippo et al.
2001/0010737 A1	8/2001	Olin	2009/0052814 A1	2/2009	Michalsky
2001/0015054 A1	8/2001	Caudle	2009/0060399 A1	3/2009	Basque et al.
2001/0030192 A1	10/2001	Redmond	2009/0071960 A1	3/2009	Nagata et al.
2002/0000441 A1	1/2002	Redmond	2009/0097786 A1	4/2009	Goglio et al.
2002/0081405 A1	6/2002	Marbler et al.	2009/0169137 A1	7/2009	Allerup et al.
2002/0100699 A1	8/2002	Yoon	2009/0181132 A1	7/2009	Hughes et al.
2002/0175105 A1	11/2002	Suzuura et al.	2009/0205998 A1	8/2009	Klaus
			2009/0238502 A1	9/2009	Bhattacharjee et al.
			2009/0241483 A1	10/2009	Detwiler et al.
			2009/0245697 A1	10/2009	Yamazumi et al.
			2009/0257690 A1	10/2009	Spenceley et al.

(56)

References Cited

U.S. PATENT DOCUMENTS		
2009/0304873	A1	12/2009 Magnoni
2010/0008602	A1	1/2010 Risgalla
2010/0038361	A1	2/2010 Hwang
2010/0166924	A1	7/2010 Leathersich et al.
2010/0176020	A1	7/2010 Scarpy
2010/0176125	A1	7/2010 Van Puijenbroek
2010/0177993	A1	7/2010 Chen
2010/0195940	A1	8/2010 Michalsky et al.
2010/0272868	A1	10/2010 Krysty et al.
2010/0300901	A1	12/2010 Perell et al.
2010/0320206	A1	12/2010 Caldwell et al.
2010/0326989	A1	12/2010 Perell et al.
2011/0079594	A1	4/2011 White
2011/0110613	A1	5/2011 Futase
2011/0132927	A1	6/2011 Ankudinov
2011/0139647	A1	6/2011 Petricca et al.
2011/0147260	A1	6/2011 Perchtold et al.
2011/0150371	A1	6/2011 Bosman et al.
2011/0158564	A1	6/2011 Krumme
2011/0170806	A1	7/2011 Latour
2011/0192754	A1	8/2011 Slominski et al.
2011/0192849	A1	8/2011 Osorio
2011/0233267	A1	9/2011 Weber et al.
2011/0266180	A1	11/2011 Wipf et al.
2011/0278298	A1	11/2011 Zaggia et al.
2011/0293208	A1	12/2011 Cheema et al.
2011/0297681	A1	12/2011 Bowers
2012/0000968	A1	1/2012 Coyne et al.
2012/0002906	A1	1/2012 Bossel
2012/0125934	A1	5/2012 Goglio et al.
2012/0187122	A1	7/2012 Glasow
2012/0187125	A1	7/2012 Plourde
2012/0223099	A1	9/2012 Sanchez
2012/0234835	A1	9/2012 Minnette
2012/0269468	A1	10/2012 Prizzi et al.
2012/0273461	A1	11/2012 Velasquez Urey et al.
2012/0273560	A1	11/2012 Rupp
2013/0008134	A1	1/2013 Kim et al.
2013/0084367	A1	4/2013 Caldwell et al.
2013/0089280	A1	4/2013 Tseng et al.
2013/0118134	A1	5/2013 Perell et al.
2013/0121623	A1	5/2013 Lyzenga et al.
2013/0161323	A1	6/2013 Ure
2013/0167864	A1	7/2013 Remus et al.
2013/0167865	A1	7/2013 Kerr et al.
2013/0170772	A1	7/2013 De With et al.
2013/0177261	A1	7/2013 Bushaw
2013/0182977	A1	7/2013 Gagne et al.
2013/0206631	A1	8/2013 Bazbaz
2013/0209002	A1	8/2013 Bazbaz
2013/0209003	A1	8/2013 Hansen et al.
2013/0209623	A1	8/2013 Beaumont
2013/0233877	A1	9/2013 Thimmesch
2013/0233879	A1	9/2013 Thimmesch et al.
2013/0251290	A1	9/2013 Sterling et al.
2013/0270146	A1	10/2013 Iannello et al.
2013/0295242	A1	11/2013 Cheema
2013/0330026	A1	12/2013 Shook et al.
2013/0341364	A1	12/2013 Di Bono et al.
2013/0343679	A1	12/2013 Itou et al.
2014/0044381	A1	2/2014 Ulstad et al.
2014/0047803	A1	2/2014 Perell et al.
2014/0069927	A1	3/2014 Willemsen
2014/0099409	A1	4/2014 Cassens et al.
2014/0099410	A1	4/2014 Cassens et al.
2014/0103057	A1	4/2014 Fuisz et al.
2014/0116906	A1	5/2014 Trombley et al.
2014/0123607	A1	5/2014 Valencia et al.
2014/0138382	A1	5/2014 Willemsen
2014/0170272	A1	6/2014 Caron et al.
2014/0185965	A1	7/2014 Lyzenga
2014/0190989	A1	7/2014 Thimmesch
2014/0193105	A1	7/2014 Adams et al.
2014/0197201	A1	7/2014 Thimmesch et al.
2014/0205218	A1	7/2014 Bazbaz et al.
2014/0205219	A1	7/2014 Bazbaz et al.
2014/0212077	A1	7/2014 Han et al.
2014/0250838	A1	9/2014 Nathan
2014/0262904	A1	9/2014 Young et al.
2014/0287106	A1	9/2014 Labrousse Molla et al.
2014/0299625	A1	10/2014 Franco Soutello et al.
2014/0348445	A1	11/2014 Siesto Casanova et al.
2014/0370147	A1	12/2014 Hentzel et al.
2014/0374420	A9	12/2014 Kanderka et al.
2014/0376835	A1	12/2014 Rogers et al.
2015/0003758	A1	1/2015 Warrington et al.
2015/0021218	A1	1/2015 McKenzie
2015/0048090	A1	2/2015 Bandou
2015/0055895	A1	2/2015 Kishi et al.
2015/0131928	A1	5/2015 Exner et al.
2015/0136628	A1	5/2015 Bertelsen et al.
2015/0144518	A1	5/2015 Mathew et al.
2015/0183564	A1	7/2015 Henderson
2015/0197385	A1	7/2015 Wei
2015/0203245	A1	7/2015 Gayer
2015/0217919	A1	8/2015 Varbanov et al.
2015/0217921	A1	8/2015 On et al.
2015/0225126	A1	8/2015 Sharpe et al.
2015/0225160	A1	8/2015 Andrews
2015/0239651	A1	8/2015 Leslie
2015/0251831	A1	9/2015 Steele
2015/0251832	A1	9/2015 Eberhardt et al.
2015/0314938	A1	11/2015 Bomba et al.
2015/0353237	A1	12/2015 Haedt et al.
2015/0375912	A1	12/2015 Fall
2016/0001950	A1	1/2016 Veternik et al.
2016/0001967	A1	1/2016 Franzen et al.
2016/0009484	A1	1/2016 Hodges
2016/0016694	A1	1/2016 Tseng et al.
2016/0023841	A1	1/2016 Villalobos
2016/0068322	A1	3/2016 Murdick et al.
2016/0090217	A1	3/2016 Schnabel
2016/0090221	A1	3/2016 Stevens et al.
2016/0122103	A1	5/2016 Havrileck et al.
2016/0130064	A1	5/2016 Klipstine et al.
2016/0137377	A1	5/2016 Tracy et al.
2016/0137396	A1	5/2016 Brownfield
2016/0145030	A1	5/2016 Malligan et al.
2016/0152406	A1	6/2016 Lloyd et al.
2016/0175194	A9	6/2016 Krumme et al.
2016/0176599	A1	6/2016 Hanus
2016/0176601	A1	6/2016 Boekeloo et al.
2016/0229613	A1	8/2016 Morofuji
2016/0244232	A1	8/2016 McNichols et al.
2016/0310253	A1	10/2016 Ferrand et al.
2016/0311580	A1	10/2016 Ozaki et al.
2016/0311596	A1	10/2016 Perell et al.
2016/0311598	A1	10/2016 O'Hagan et al.
2016/0368683	A1	12/2016 Bazbaz
2017/0015478	A1	1/2017 Sebald et al.
2017/0029174	A1	2/2017 Steele et al.
2017/0029189	A1	2/2017 Sanders et al.
2017/0036822	A1	2/2017 Sam
2017/0043926	A1	2/2017 Futase
2017/0088326	A1	3/2017 Marken
2017/0121083	A1	5/2017 Hishinuma
2017/0129681	A1	5/2017 Stow et al.
2017/0137194	A1	5/2017 Lorence
2017/0144822	A1	5/2017 Murray
2017/0152093	A1	6/2017 Simonsen et al.
2017/0166337	A1	6/2017 Sharp et al.
2017/0203534	A1	7/2017 Lahti et al.
2017/0203900	A1	7/2017 Thobe
2017/0216557	A1	8/2017 Keams et al.
2017/0225839	A1	8/2017 Bazbaz
2017/0225860	A1	8/2017 van den Berg et al.
2017/0233157	A1	8/2017 Thobe
2017/0233159	A1	8/2017 Cruz
2017/0253403	A1	9/2017 Evans et al.
2017/0253404	A1	9/2017 Katz et al.
2017/0253406	A1	9/2017 Wallander
2017/0259979	A1	9/2017 Cruz
2017/0283146	A1	10/2017 Polikeit et al.
2017/0283149	A1	10/2017 Rhue

(56)

References Cited

U.S. PATENT DOCUMENTS

2017/0297797 A1 10/2017 VanGordon et al.
 2017/0297800 A1 10/2017 Hall et al.
 2017/0305609 A1 10/2017 McGuire et al.

FOREIGN PATENT DOCUMENTS

WO 2013134377 A1 9/2013
 WO 2014058749 A1 4/2014
 WO 2014126515 A1 8/2014
 WO 2014132663 A1 9/2014
 WO 2014168630 A1 10/2014
 WO 2015002651 A1 1/2015
 WO 2015012836 A1 1/2015
 WO 2015019225 A1 2/2015
 WO 2015081084 A2 6/2015
 WO 2015103176 A1 7/2015
 WO 2015108259 A1 7/2015

WO 2015112110 A1 7/2015
 WO 2015139845 A1 9/2015
 WO 2015153854 A1 10/2015
 WO 2015182289 A1 12/2015
 WO 2015185521 A1 12/2015
 WO 2015186251 A1 12/2015
 WO 2015191714 A1 12/2015
 WO 2015195727 A2 12/2015
 WO 2016014052 A1 1/2016
 WO 2016024963 A1 2/2016
 WO 2016024964 A1 2/2016
 WO 2016027399 A1 2/2016
 WO 2016030416 A1 3/2016
 WO 2016044816 A1 3/2016
 WO 2016057046 A1 4/2016
 WO 2016057627 A1 4/2016
 WO 2016085522 A1 6/2016
 WO 2016100852 A1 6/2016
 WO 2017087732 A1 5/2017

* cited by examiner

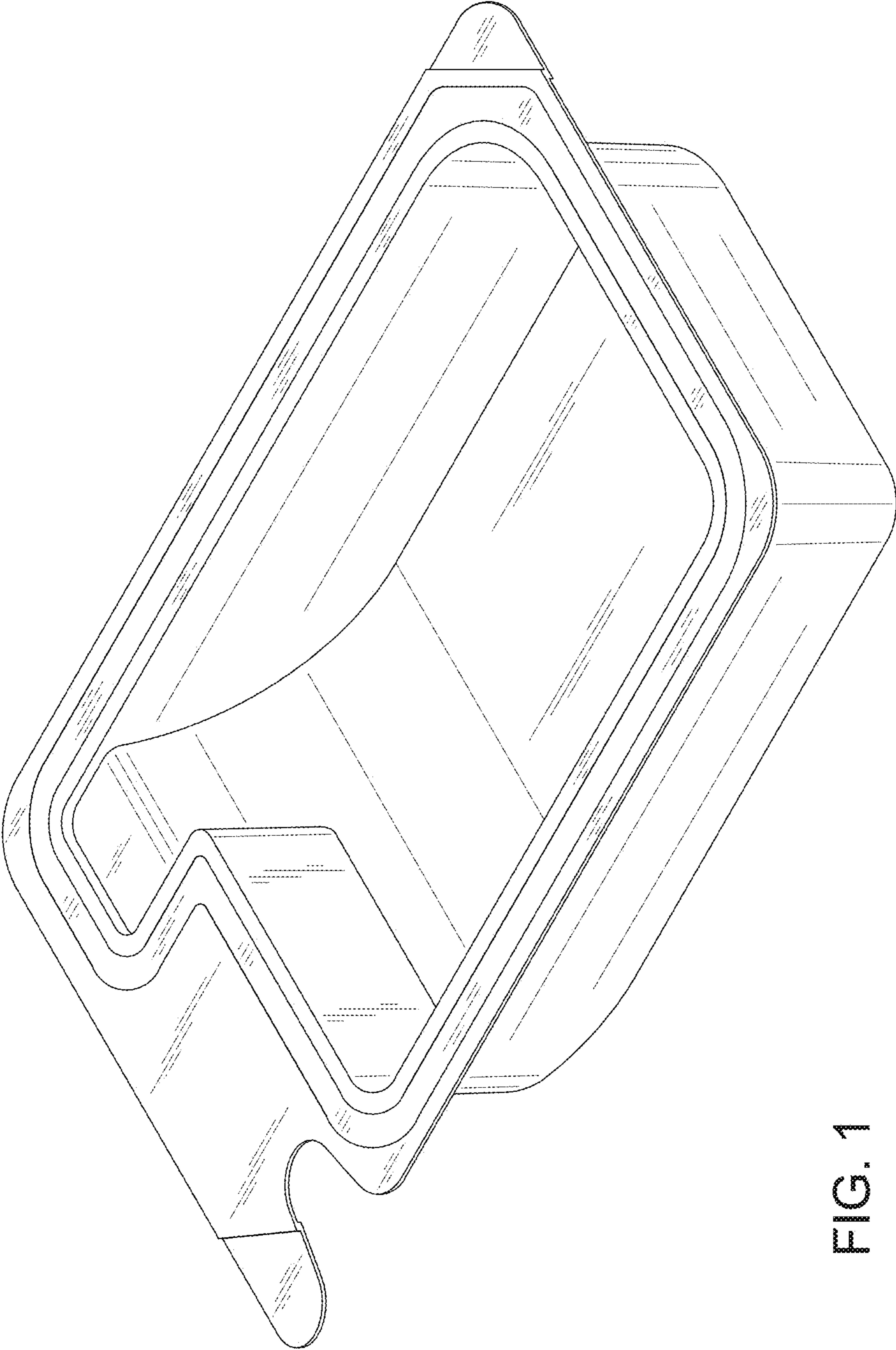

FIG. 1

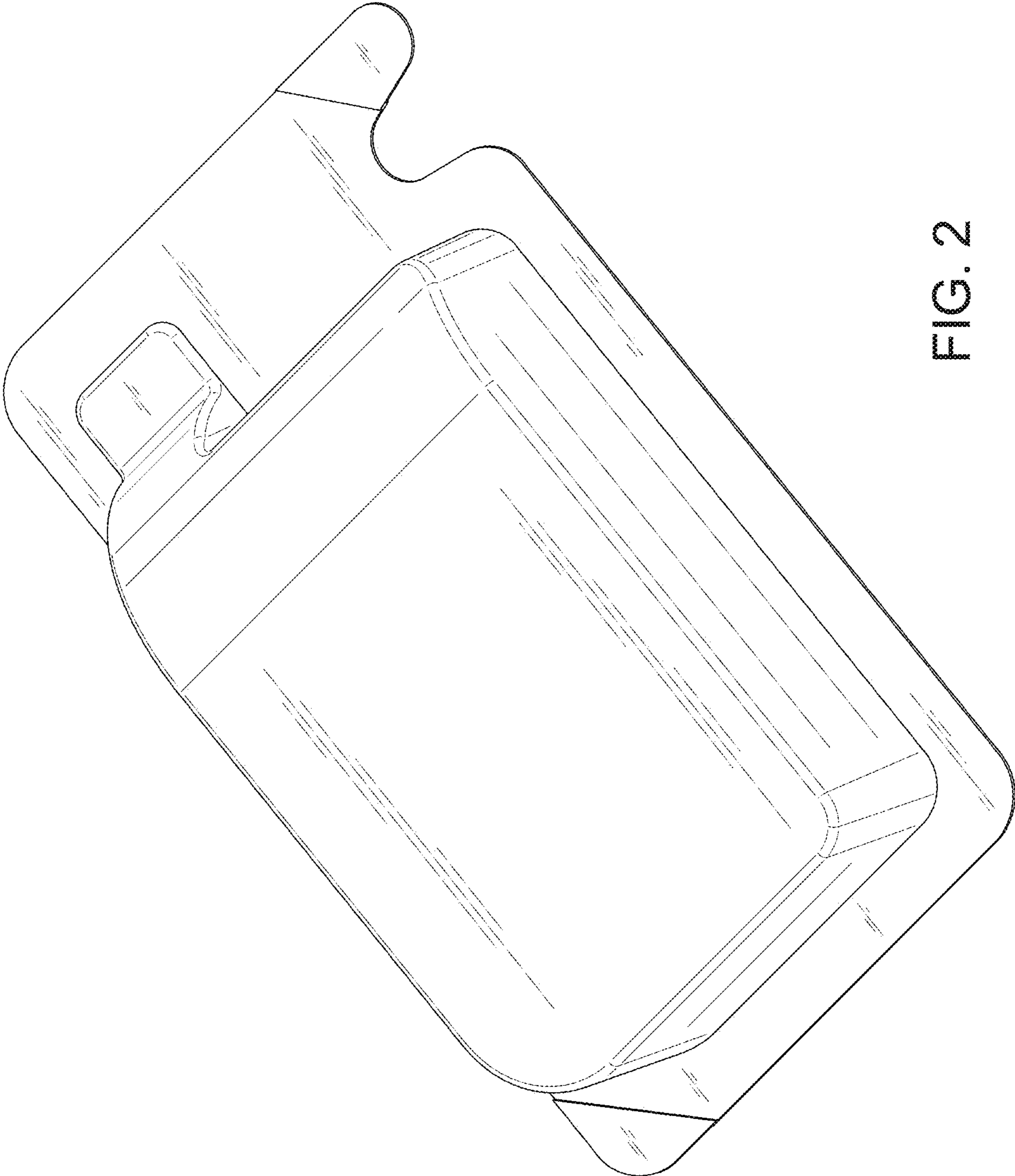

FIG. 2

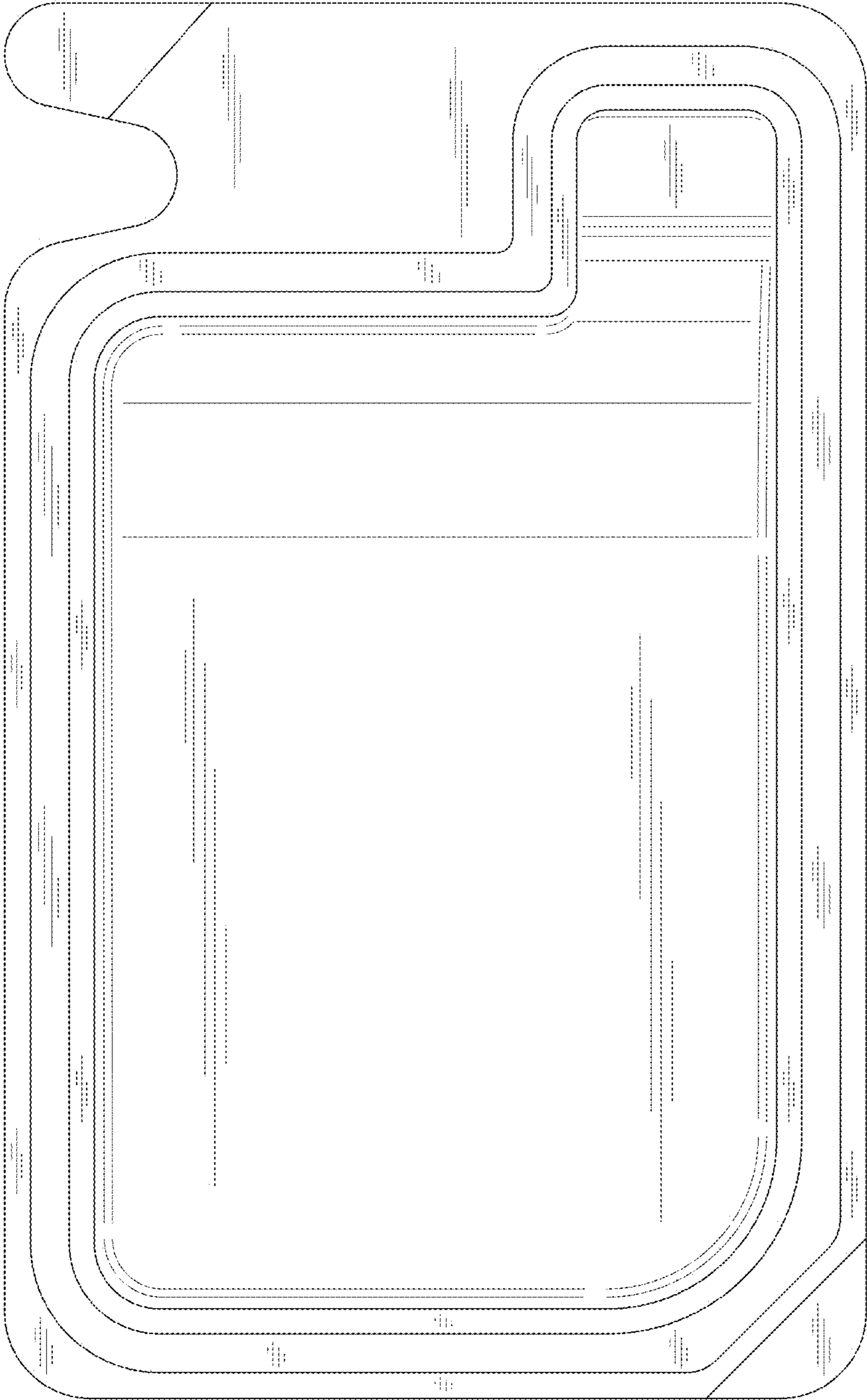

FIG. 3

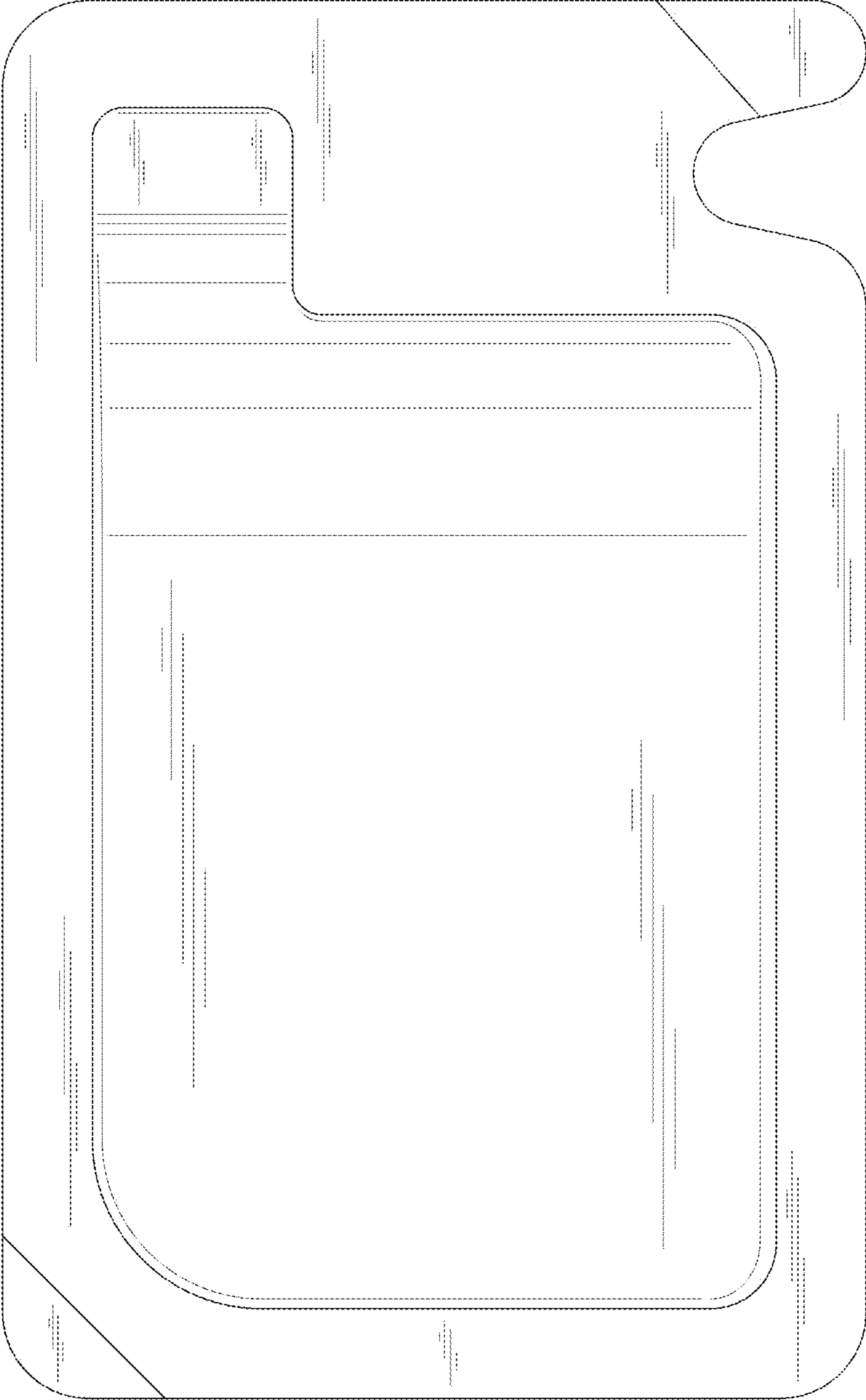

FIG. 4

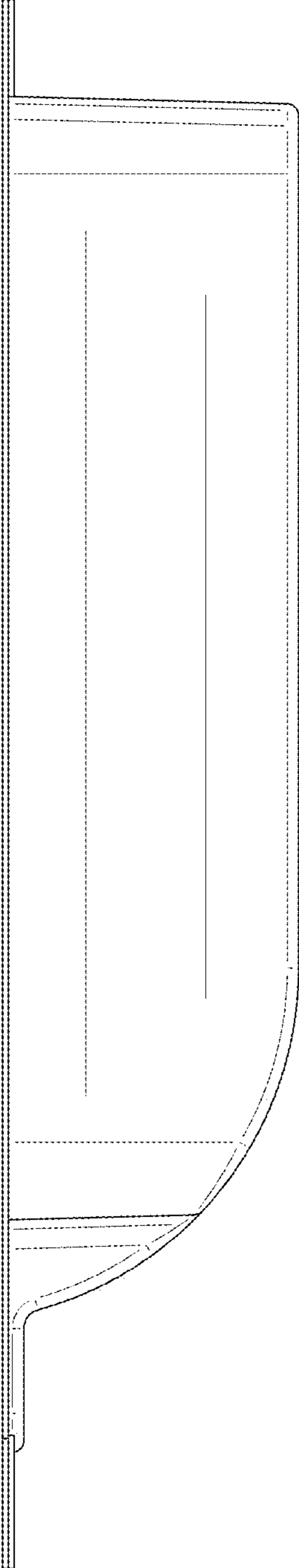

FIG. 5

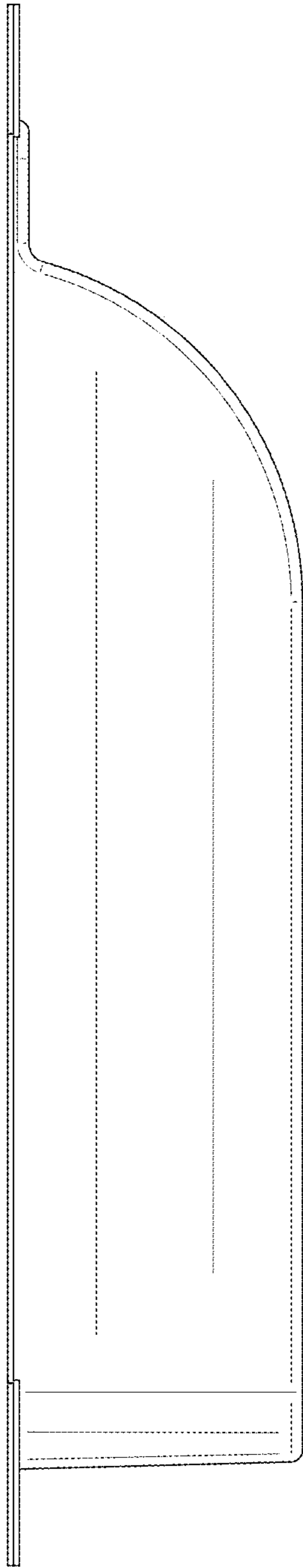

FIG. 6

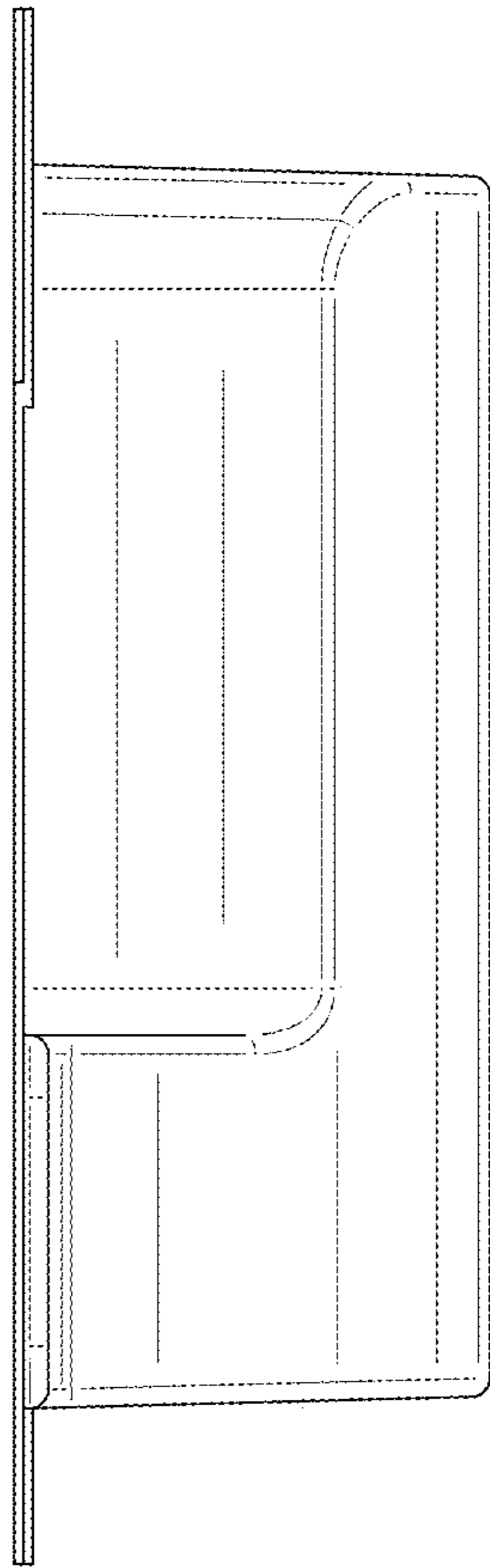

FIG. 7

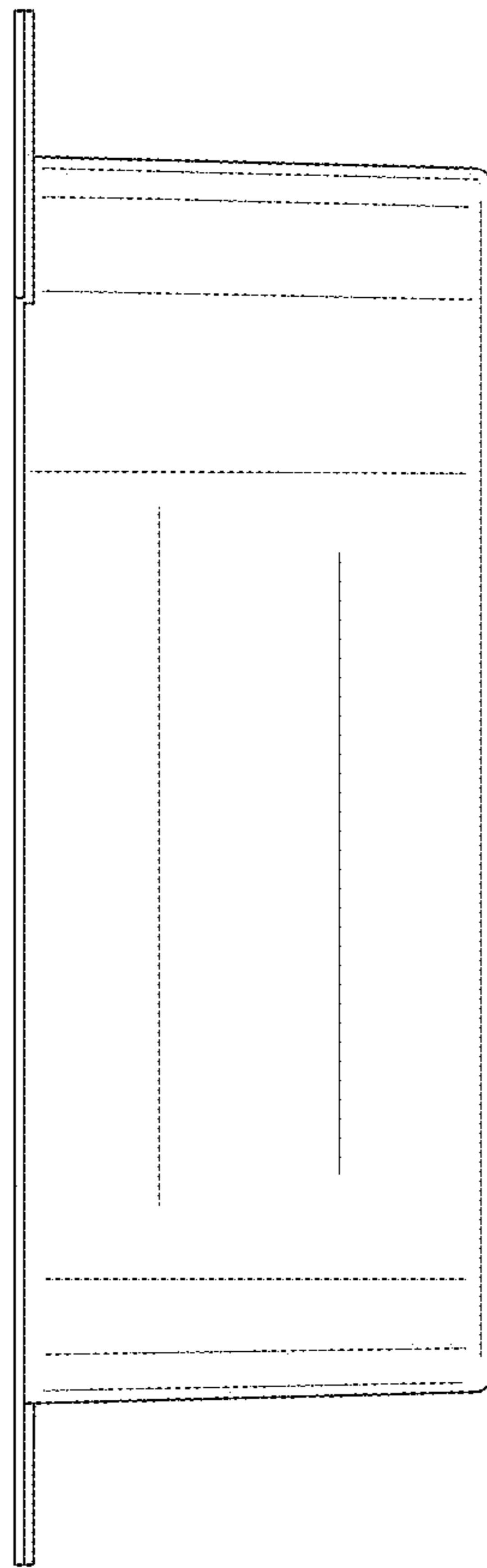

FIG. 8