



US00D896630S

(12) **United States Design Patent** (10) **Patent No.:** **US D896,630 S**
Gomez et al. (45) **Date of Patent:** **** Sep. 22, 2020**

(54) **AVOCADO CONTAINER**
(71) Applicant: **GREENFRUIT AVOCADOS, LLC**,
Newport Beach, CA (US)
(72) Inventors: **Brian E. Gomez**, Costa Mesa, CA
(US); **Philip C. Warren**, Canyon Lake,
CA (US)
(73) Assignee: **GREENFRUIT AVOCADOS, LLC**,
Newport Beach, CA (US)
(**) Term: **15 Years**
(21) Appl. No.: **29/689,580**
(22) Filed: **Apr. 30, 2019**
(51) **LOC (12) Cl.** **09-03**
(52) **U.S. Cl.**
USPC **D9/418; D9/432**
(58) **Field of Classification Search**
USPC D9/414-423, 430-433, 434, 456, 457,
D9/711, 713, 721-722, 737, 756, 758,
D9/759, 760; D20/10, 22, 27, 40, 42
CPC ... B65D 5/00; B65D 5/02; B65D 5/18; B65D
5/20
See application file for complete search history.

(56) **References Cited**
U.S. PATENT DOCUMENTS
D200,669 S * 3/1965 Swane D3/312
D208,588 S * 9/1967 Hanson D3/272
3,355,012 A * 11/1967 Weiss B65D 5/48036
206/200
4,105,152 A * 8/1978 Elward B65D 5/2047
229/112
6,889,893 B2 * 5/2005 Kent B65D 5/0015
229/120

6,938,818 B2 * 9/2005 Moorman B65D 5/10
229/120
D541,149 S * 4/2007 Moorman D9/431
D608,634 S * 1/2010 Riedi D9/432
D680,428 S * 4/2013 Vanden Boom D9/434
D690,107 S * 9/2013 Scott D3/304
D703,527 S * 4/2014 Fuller D9/418
D744,332 S * 12/2015 D'Anglade D9/432
D840,806 S * 2/2019 Bourke D9/432

OTHER PUBLICATIONS

GreenFruit Avocado's 2-count boxes debut at PMA foodservice.
[online] Published Jul. 23, 2019. Retrieved from URL: <https://www.thepacker.com/article/greenfruit-avocados-2-count-boxes-debut-pma-foodservice>.*

* cited by examiner

Primary Examiner — Vy N Koenig
(74) *Attorney, Agent, or Firm* — Myers Andras LLP;
Joseph C. Andras

(57) **CLAIM**

The ornamental design for an avocado container, as shown.

DESCRIPTION

FIG. 1 is a perspective view of an avocado container showing the new design.
FIG. 2 is a top plan view of the avocado container;
FIG. 3 is a bottom plan view of the avocado container;
FIG. 4 is a front elevational view of the avocado container;
FIG. 5 is a rear elevational view of the avocado container;
FIG. 6 is a left elevational view of the avocado container;
and,
FIG. 7 is a right elevational view of the avocado container.

1 Claim, 4 Drawing Sheets

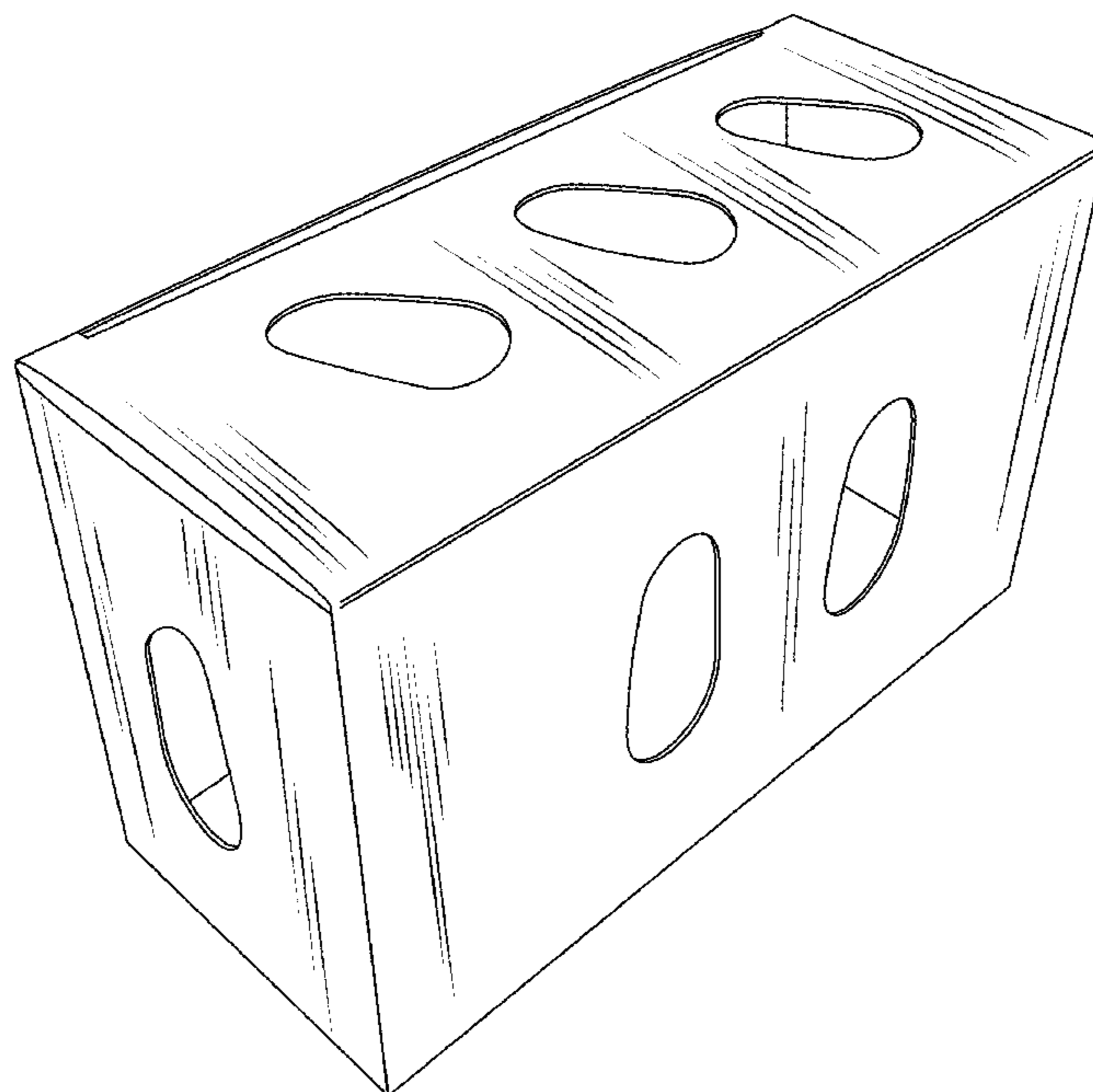

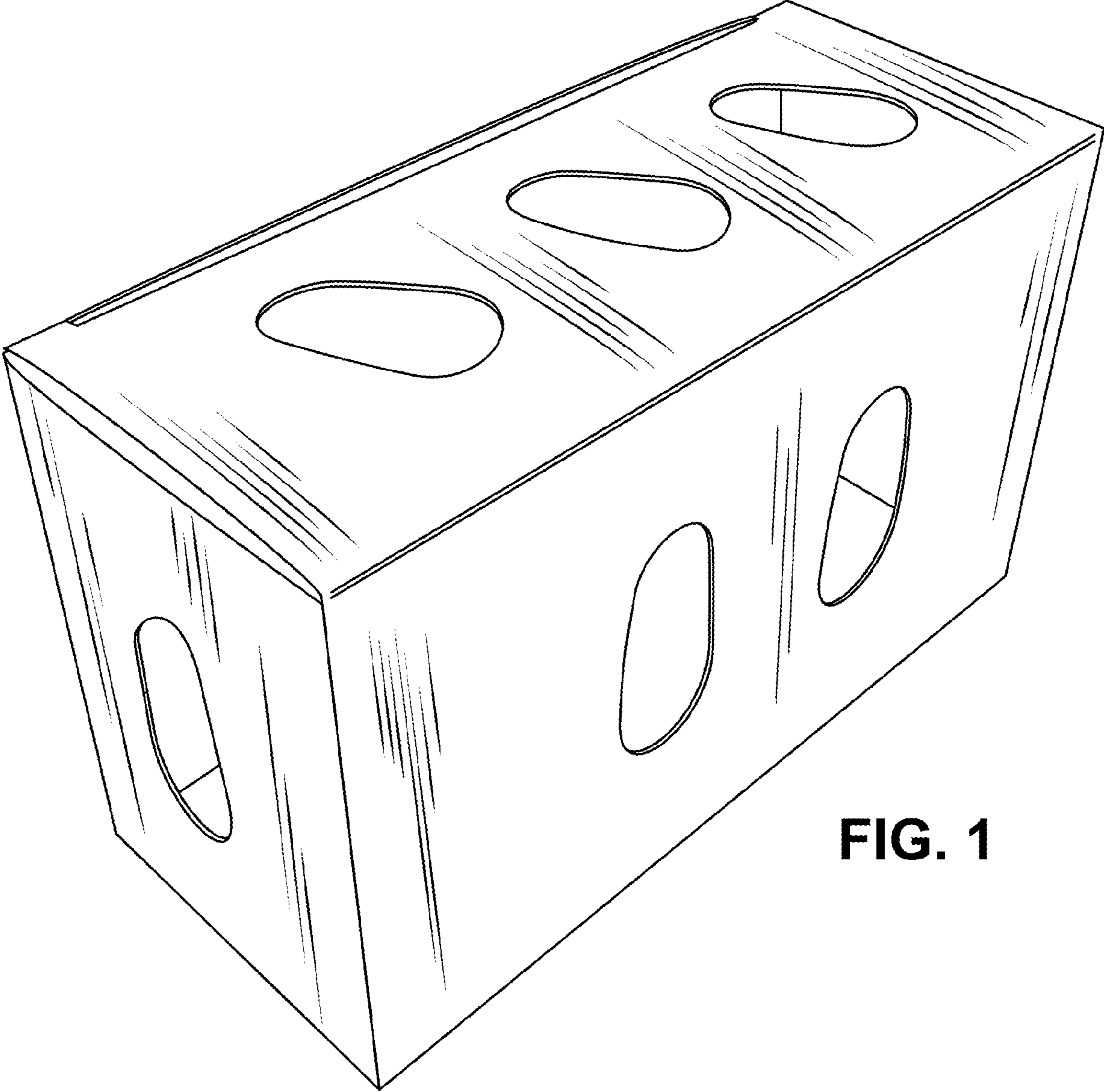

FIG. 1

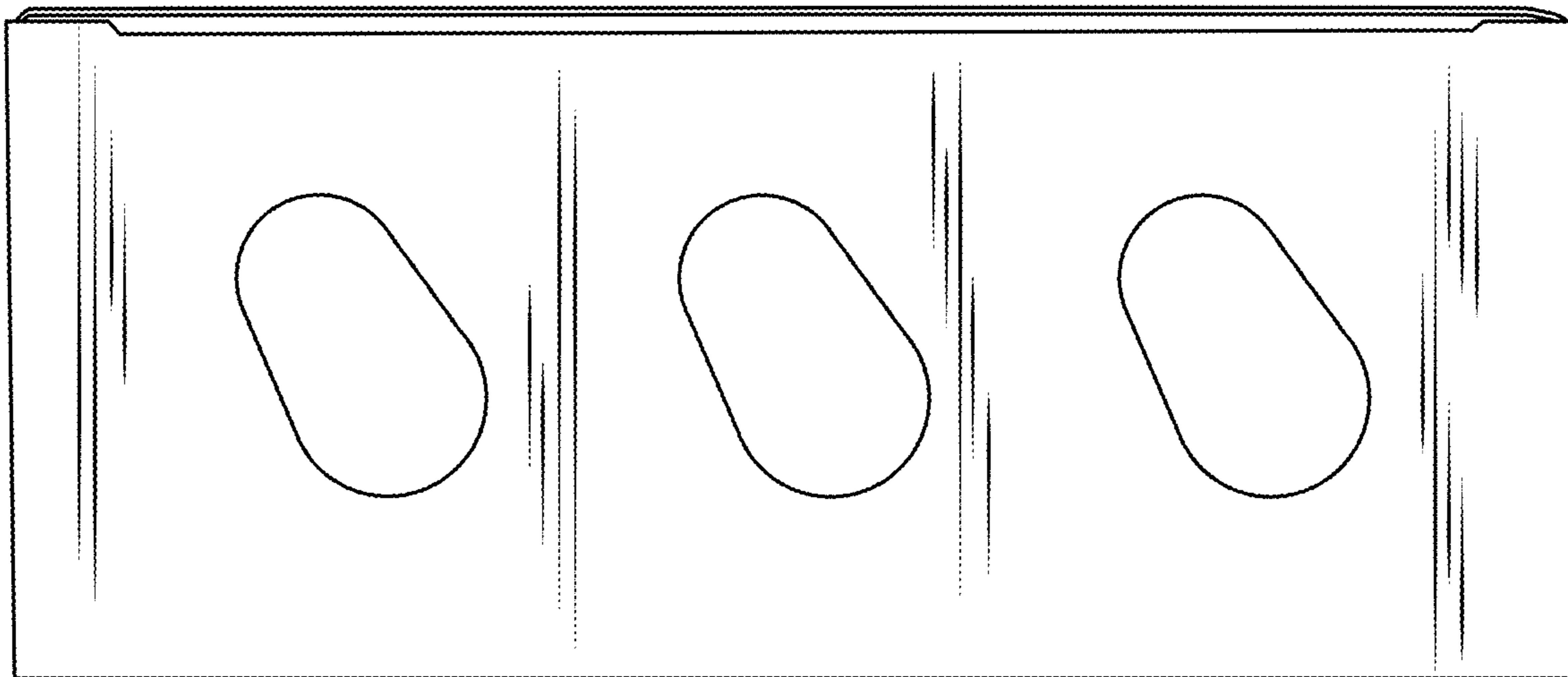

FIG. 2

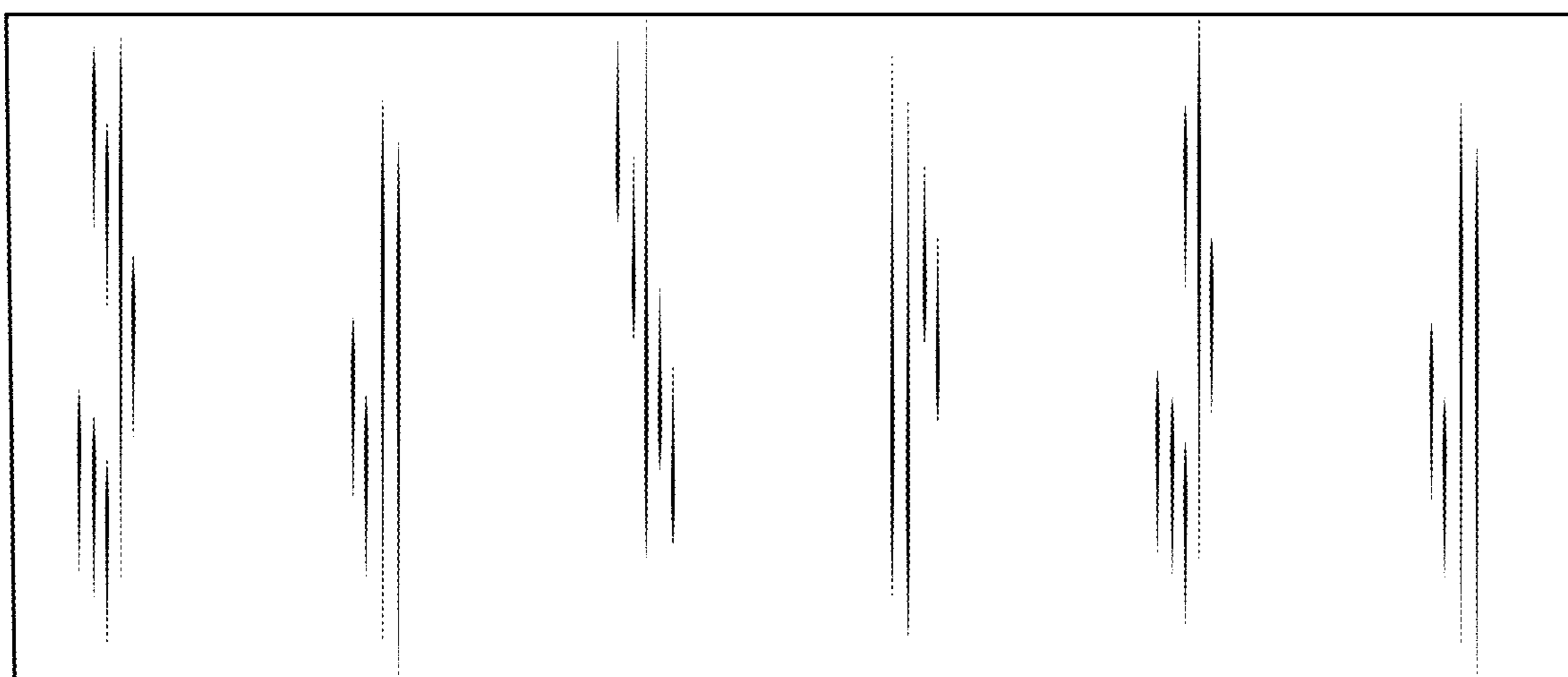

FIG. 3

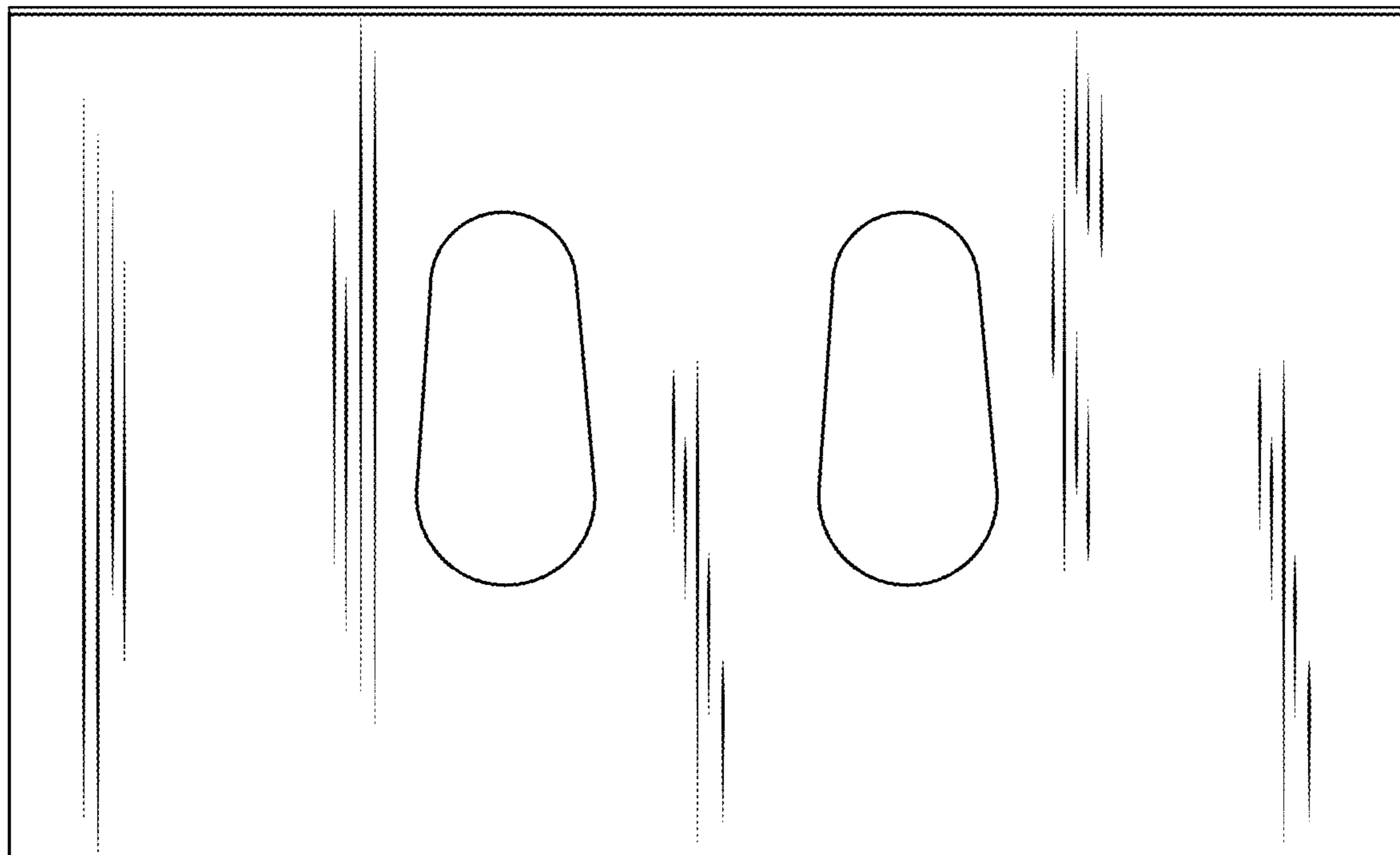

FIG. 4



FIG. 5

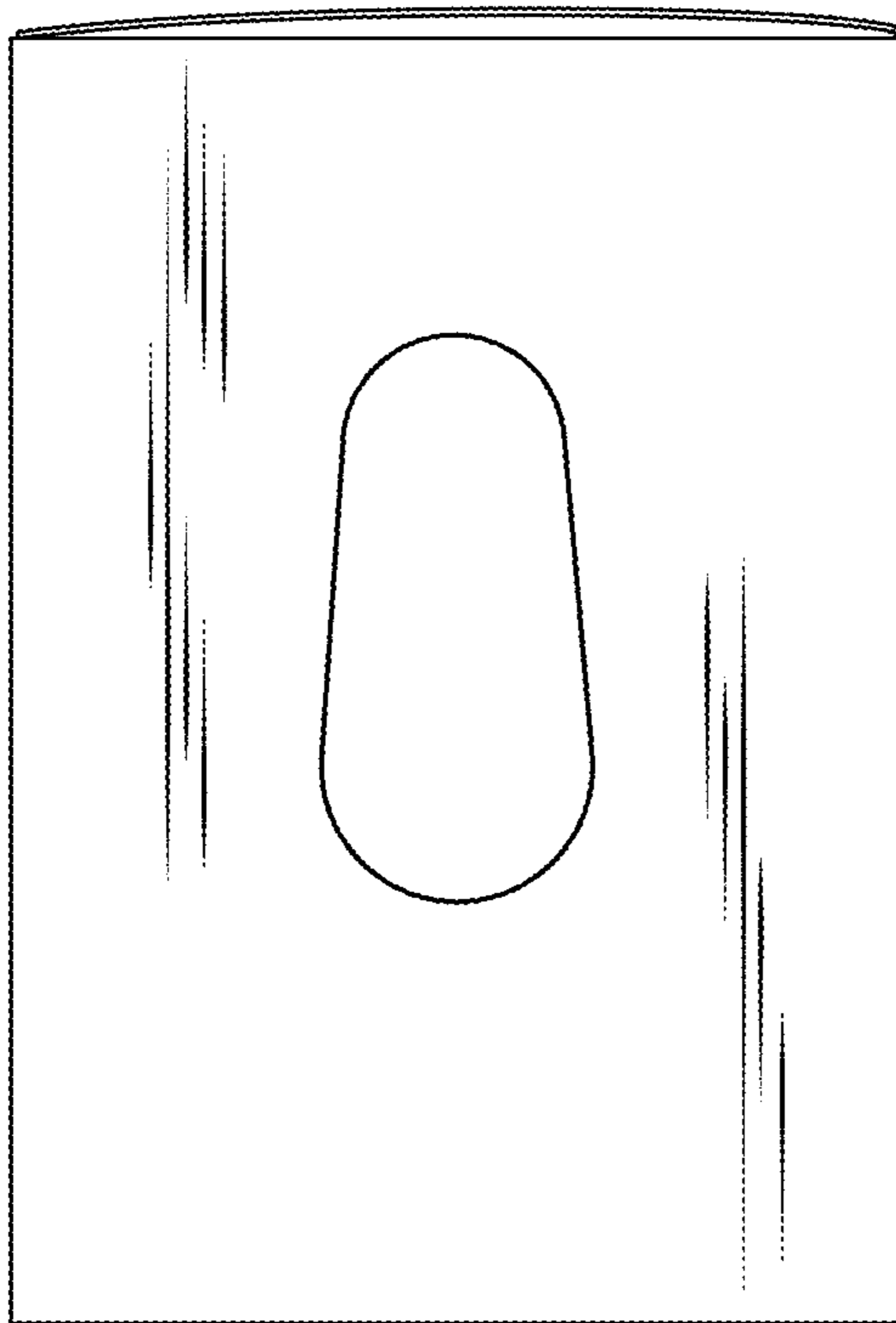

FIG. 6

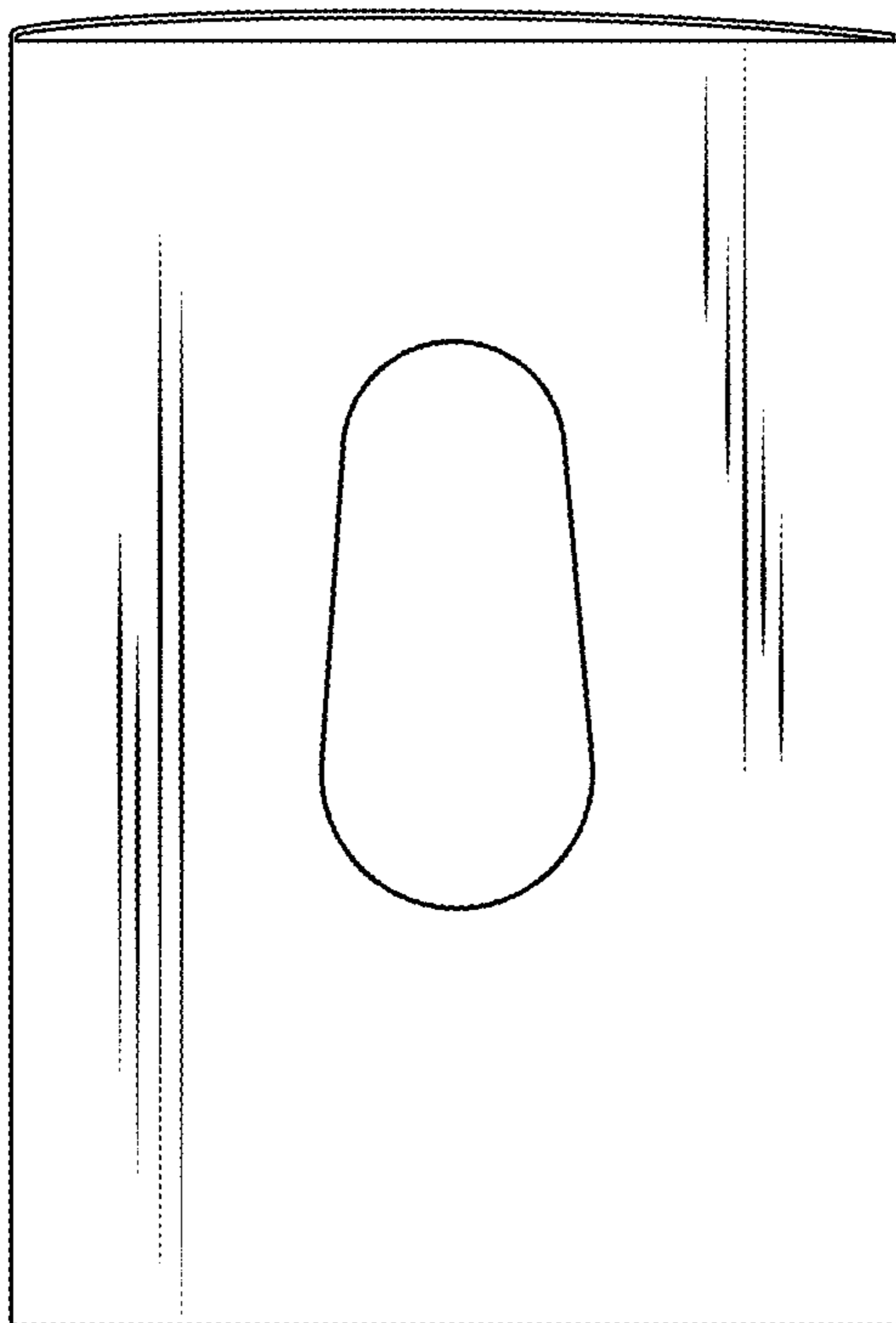

FIG. 7