



US00D896586S

(12) **United States Design Patent**
Wolfgram

(10) **Patent No.:** **US D896,586 S**

(45) **Date of Patent:** **** Sep. 22, 2020**

(54) **SKULL WITH PROJECTILE**

D809,866 S * 2/2018 Ruby D7/517
D826,640 S * 8/2018 Hirschhorn D7/507
D835,514 S * 12/2018 Alvarez D9/626

(Continued)

(71) Applicant: **BENSHOT, LLC**, Hortonville, WI
(US)

(72) Inventor: **Ben Wolfgram**, Appleton, WI (US)

(73) Assignee: **BENSHOT, LLC**, Hortonville, WI
(US)

(**) Term: **15 Years**

(21) Appl. No.: **29/700,612**

(22) Filed: **Aug. 2, 2019**

(51) **LOC (12) Cl.** **07-01**

(52) **U.S. Cl.**

USPC **D7/517**; D7/515; D7/579; D9/626

(58) **Field of Classification Search**

USPC D7/507, 510, 509, 300.1, 300, 397, 579,
D7/573, 564, 544, 514, 515, 516, 517,
D7/519, 520, 901; D3/202, 215;
222/175; 224/148.6, 148.2, 148.3;
D9/620, 626

CPC A45F 3/20; A45F 2005/008; A45F 5/00;
A45F 3/16

See application file for complete search history.

(56) **References Cited**

U.S. PATENT DOCUMENTS

D117,550 S * 11/1939 Bergeron D7/517
D459,213 S * 6/2002 Buboltz D9/626
D589,360 S * 3/2009 Alexander D9/626
D605,541 S * 12/2009 Hu D10/114.1
D689,770 S * 9/2013 Leon Fernandez D9/441
D691,415 S * 10/2013 Mason D7/396.2
D692,309 S * 10/2013 Savee D9/626
D719,406 S * 12/2014 Mason D7/517
D738,163 S * 9/2015 Roth B65D 25/20
D747,926 S * 1/2016 Mason D7/517

OTHER PUBLICATIONS

Lucky Shot USA, LLC, LuckyShotUSA Instagram webpage post,
accessed Oct. 14, 2019, <https://www.instagram.com/p/BppyncxF-ca/>.

(Continued)

Primary Examiner — Marianne N Pandozzi

(57) **CLAIM**

The ornamental design for a skull with projectile, as shown
and described.

DESCRIPTION

FIG. 1 is a front perspective view of a skull with projectile
showing my new design;
FIG. 2 is a rear elevational view thereof;
FIG. 3 is a left side elevational view thereof;
FIG. 4 is a right side elevational view thereof;
FIG. 5 is a top plan view thereof;
FIG. 6 is a bottom plan view thereof; and,
FIG. 7 is a top plan view thereof;
FIG. 8 is a bottom plan view thereof;
FIG. 9 is a front perspective view of a skull with projectile
showing a second embodiment of my new design;
FIG. 10 is a rear perspective view thereof;
FIG. 11 is a front elevation view thereof;
FIG. 12 is a rear elevation view thereof;
FIG. 13 is a right side elevation view thereof;
FIG. 14 is a left side elevation view thereof;
FIG. 15 is a top plan view thereof; and,
FIG. 16 is a bottom plan view thereof.
The broken lines in the drawing depict portions of the pirate
mug that form no part of the claimed design.

1 Claim, 8 Drawing Sheets

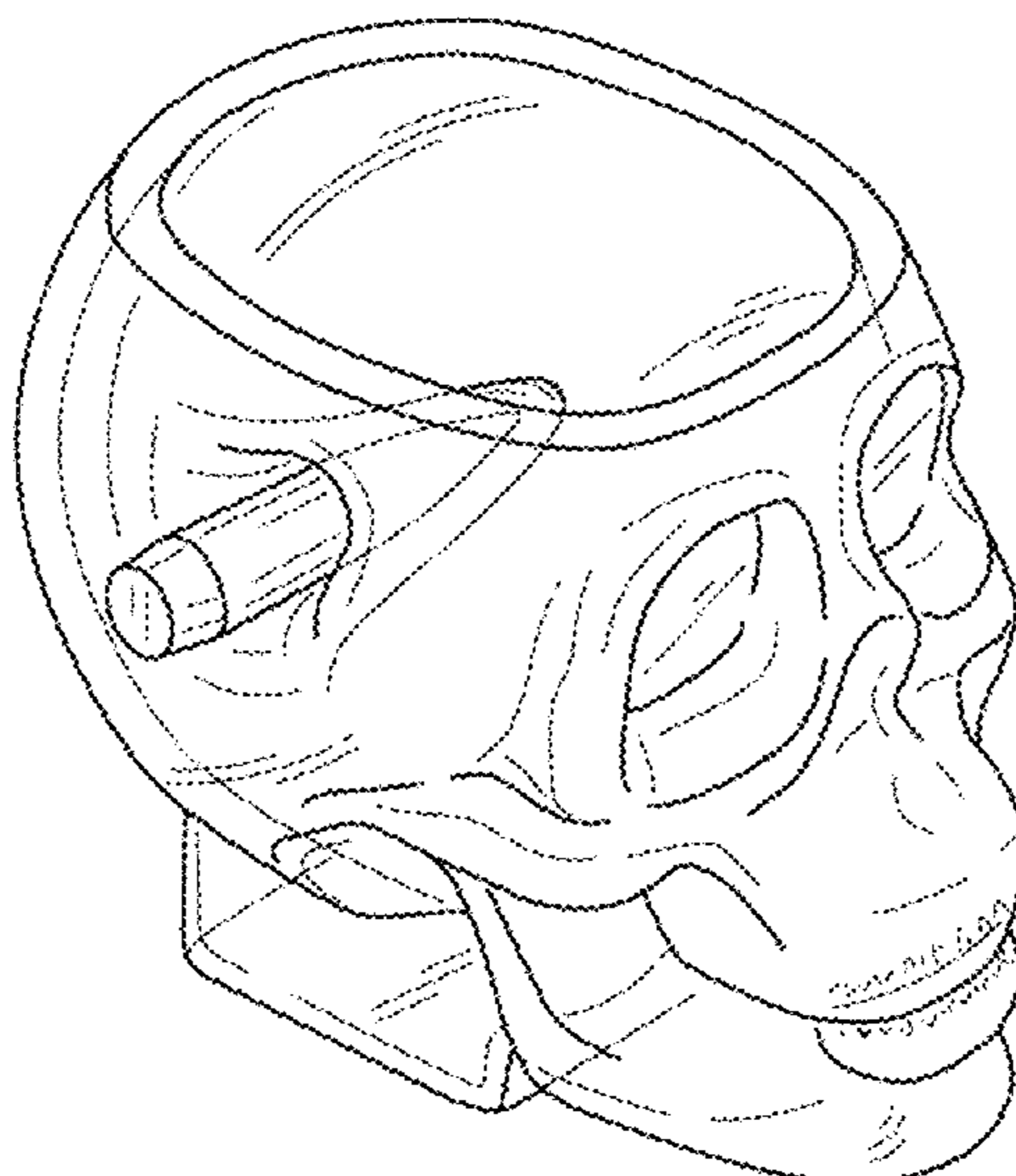

(56)

References Cited

U.S. PATENT DOCUMENTS

D861,491 S * 10/2019 Pinhasy D9/611
D883,031 S * 5/2020 Wolfgram D7/515

OTHER PUBLICATIONS

Lucky Shot USA, LLC, LuckyShotUSA Instagram webpage post, accessed Oct. 14, 2019, <https://www.instagram.com/p/Bs6FfrUHdmD/>.

Lucky Shot USA, LLC, LuckyShotUSA Instagram webpage post, accessed Oct. 14, 2019, <https://www.instagram.com/p/BtY0m7iANLo/>.

Lucky Shot USA, LLC, LuckyShotUSA Instagram webpage post, accessed Oct. 14, 2019, https://www.instagram.com/p/Bt_gDV8jl4R/.

Lucky Shot USA, LLC, LuckyShotUSA Instagram webpage post, accessed Oct. 14, 2019, <https://www.instagram.com/p/Bvwa7jcjv4m/>.

Lucky Shot USA, LLC, LuckyShotUSA Instagram webpage post, accessed Oct. 14, 2019, <https://www.instagram.com/p/BwrjBDug5tH/>.

Lucky Shot USA, LLC, LuckyShotUSA Instagram webpage post, accessed Oct. 14, 2019, <https://www.instagram.com/p/ByDWzarAU0s/>.

Lucky Shot USA, LLC, Instagram webpage post, accessed Oct. 14, 2019, <https://www.instagram.com/p/Byn1PVlglpW/>.

Lucky Shot USA, LLC, Instagram webpage post, accessed Oct. 14, 2019, <https://www.instagram.com/p/ByiFzf2H1OV/>.

Lucky Shot USA, LLC, Lucky Shot USA product page, accessed Oct. 14, 2019, <https://web.archive.org/web/20190121223728/https://luckyshotusa.com/>.

* cited by examiner

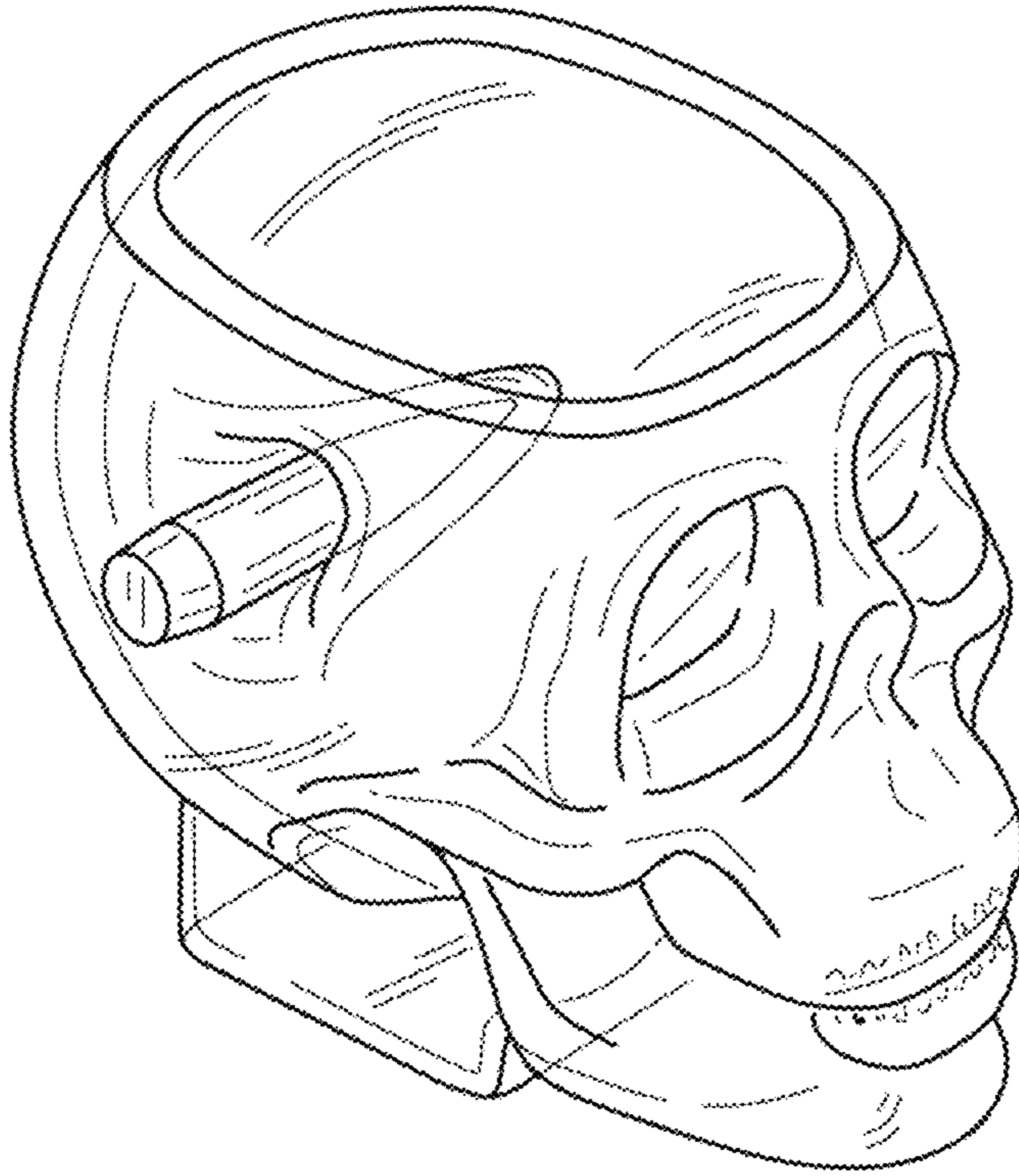

FIG. 1

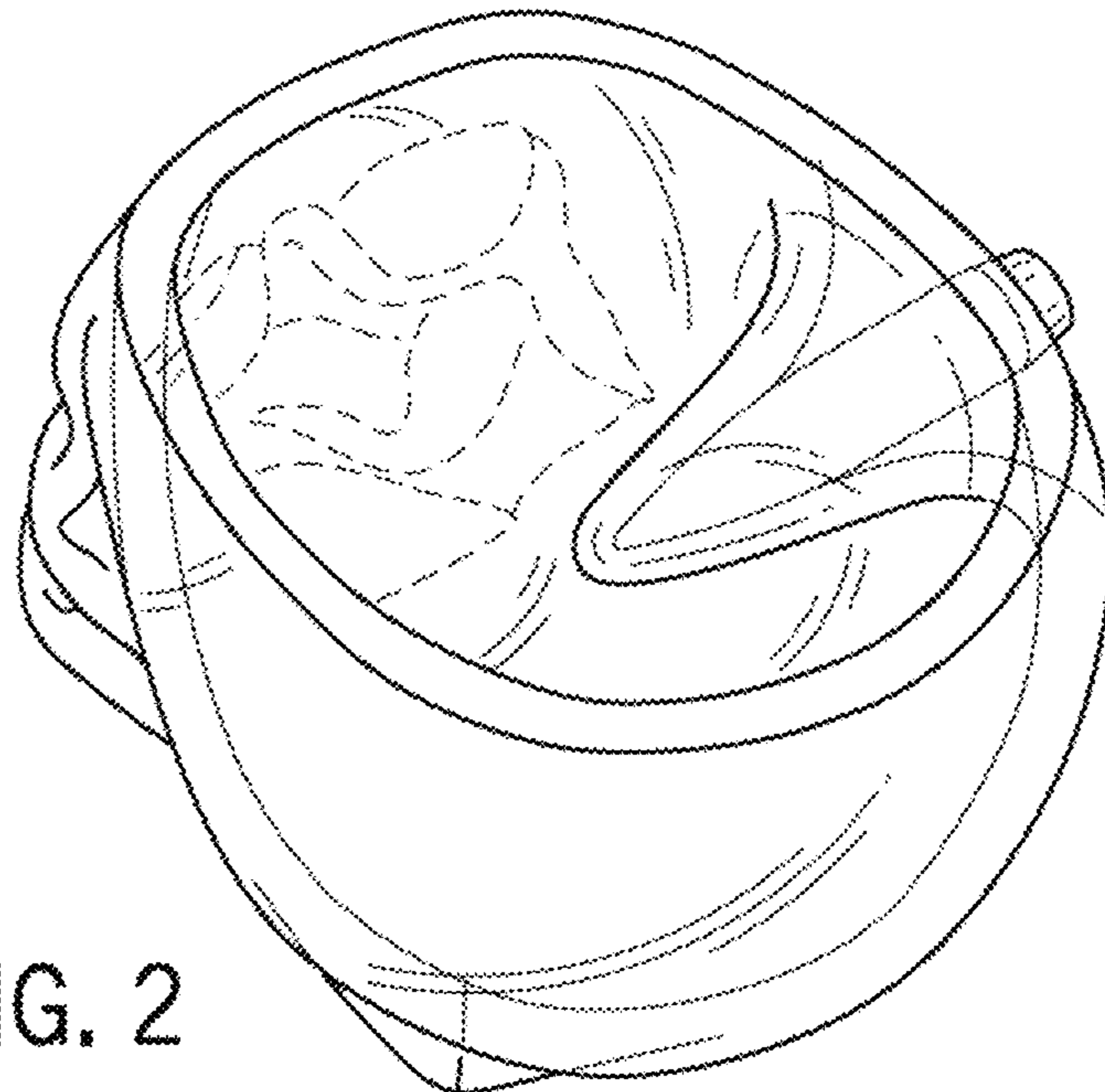

FIG. 2

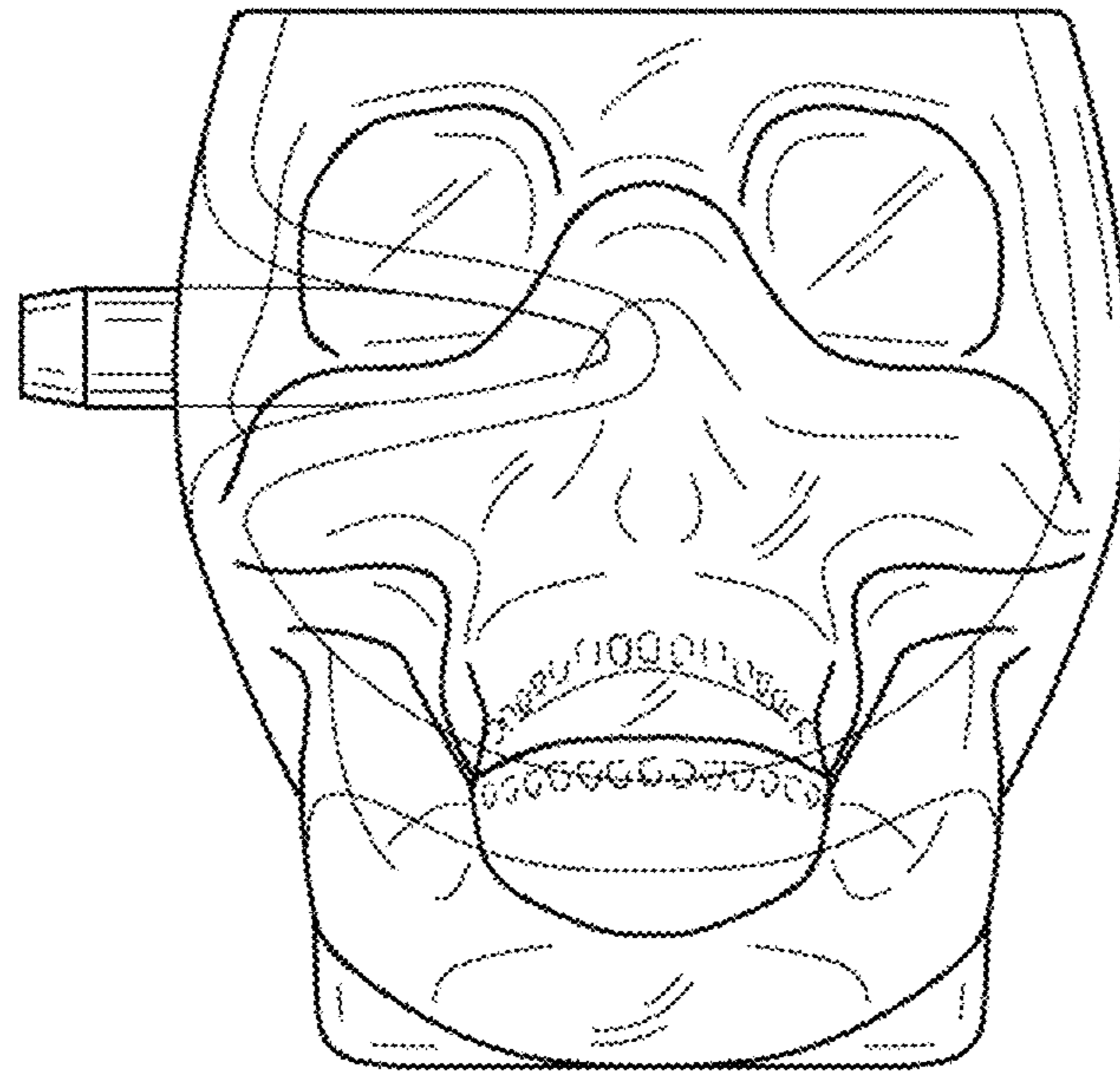

FIG. 3

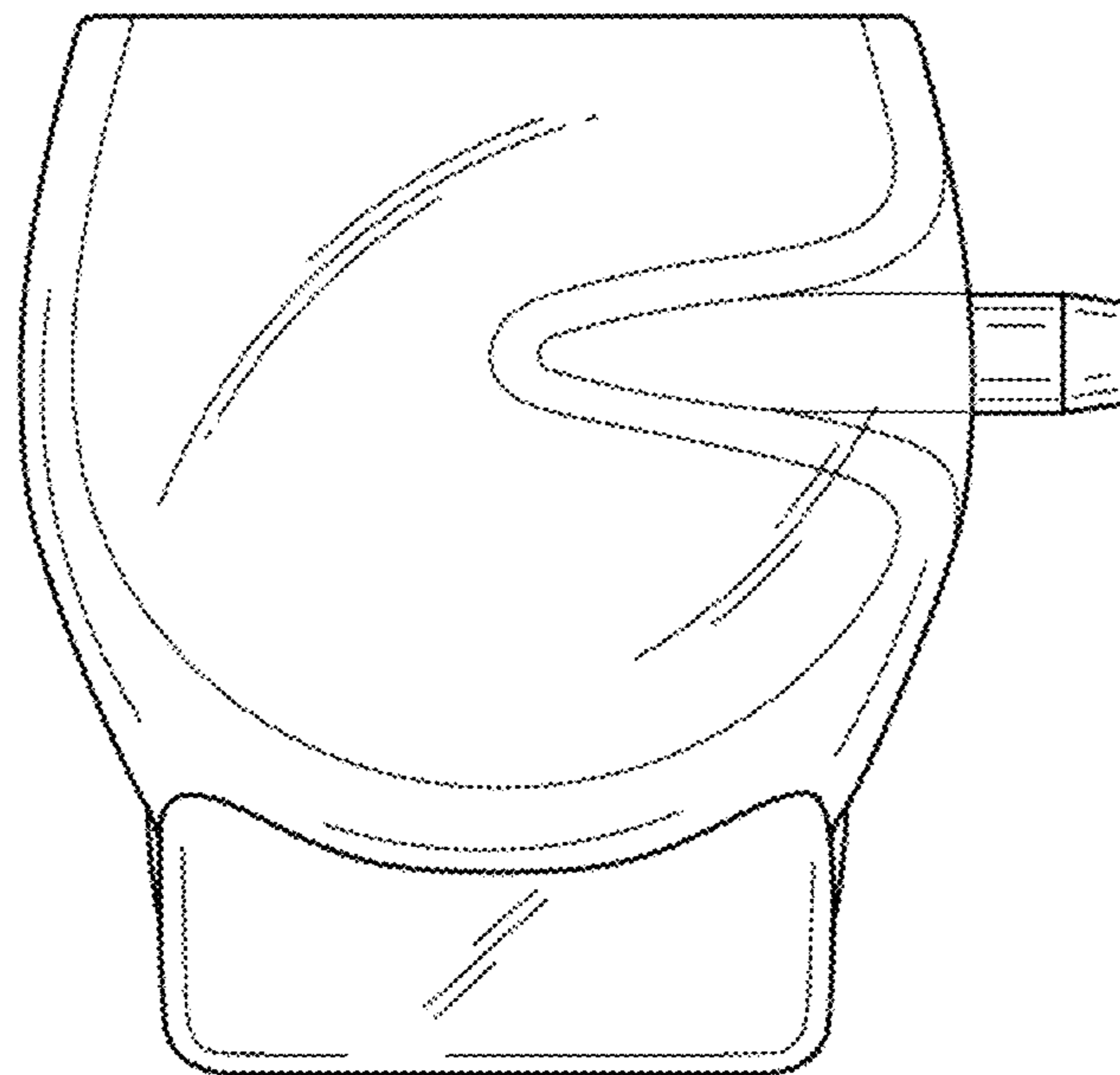

FIG. 4

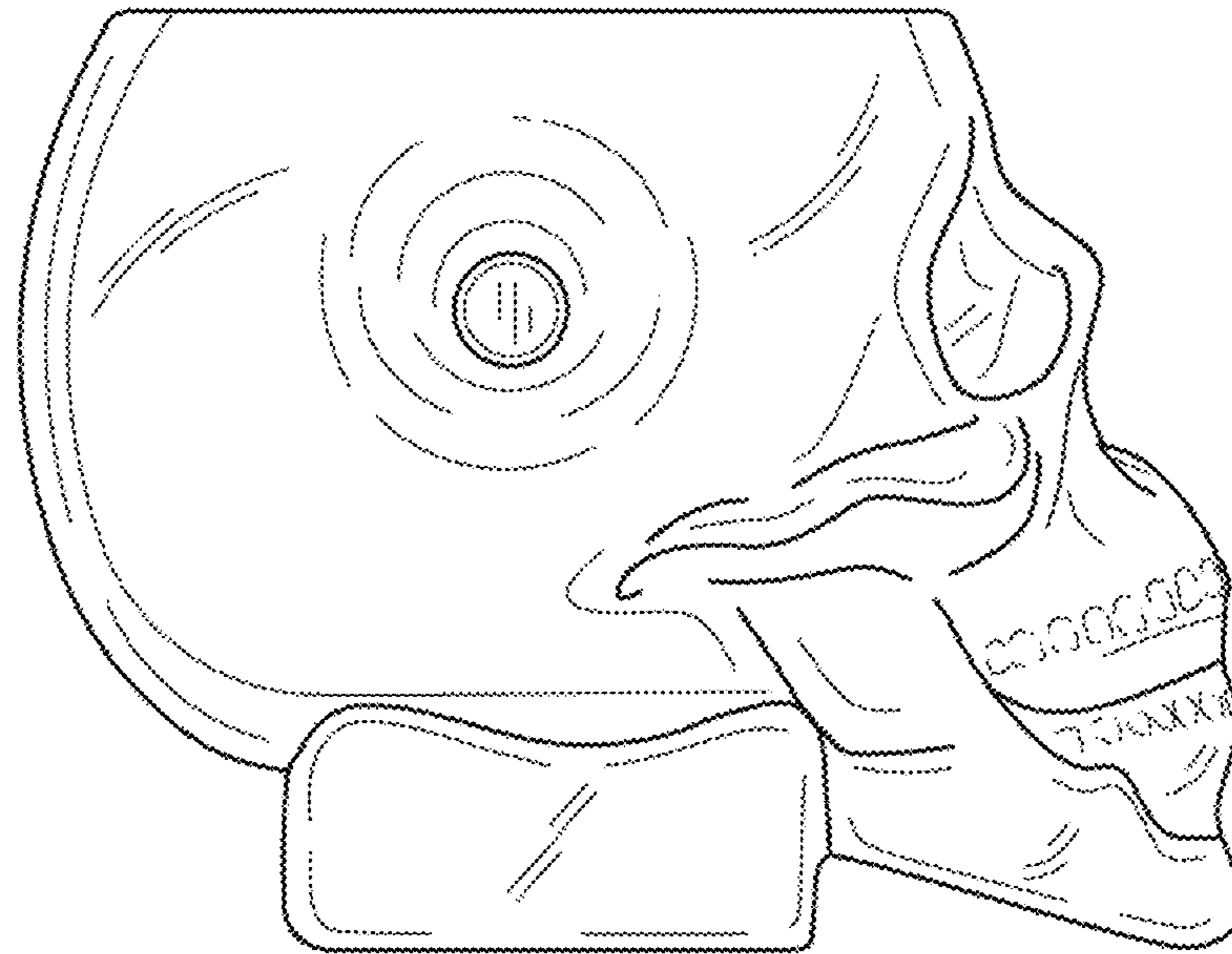

FIG. 5

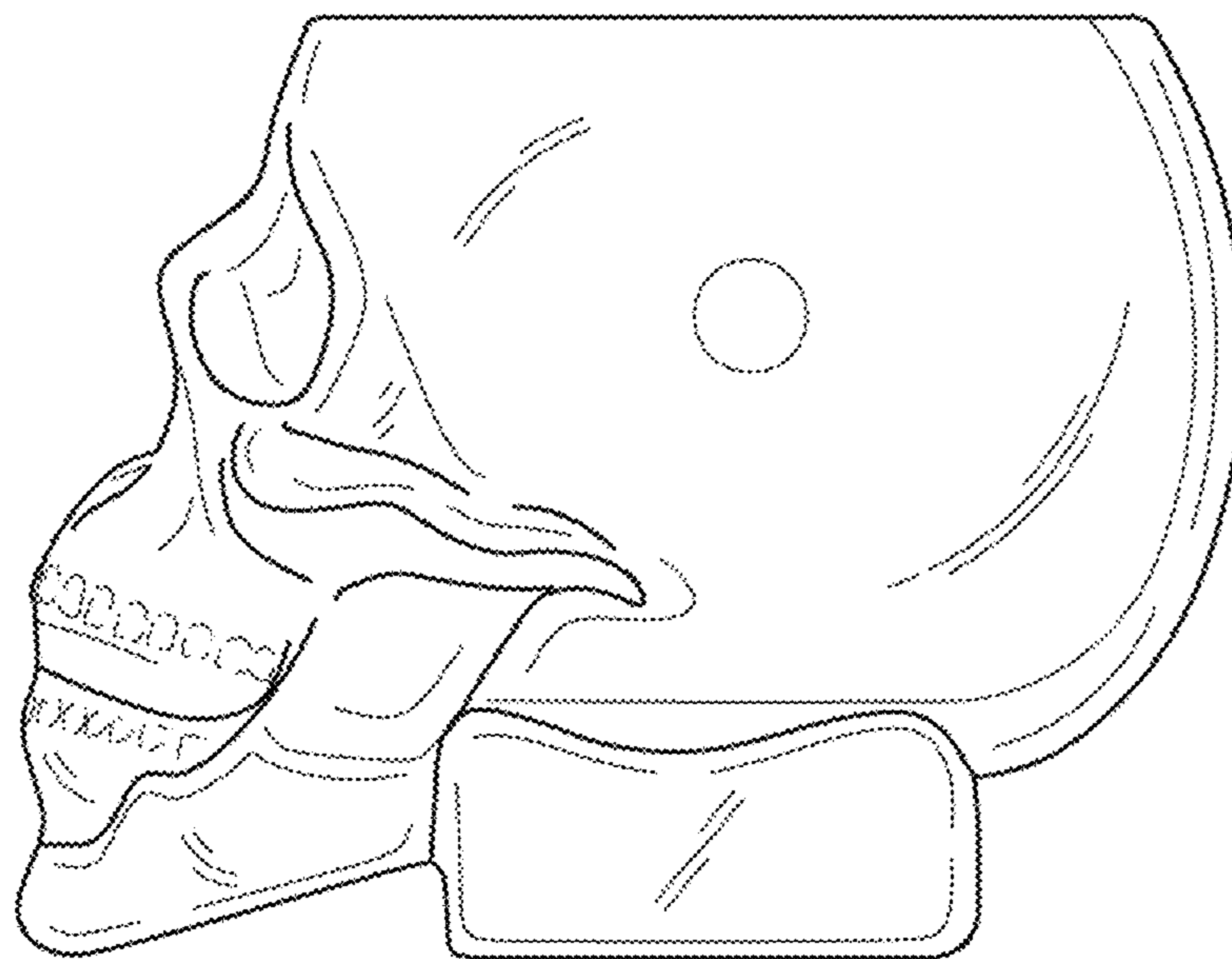

FIG. 6

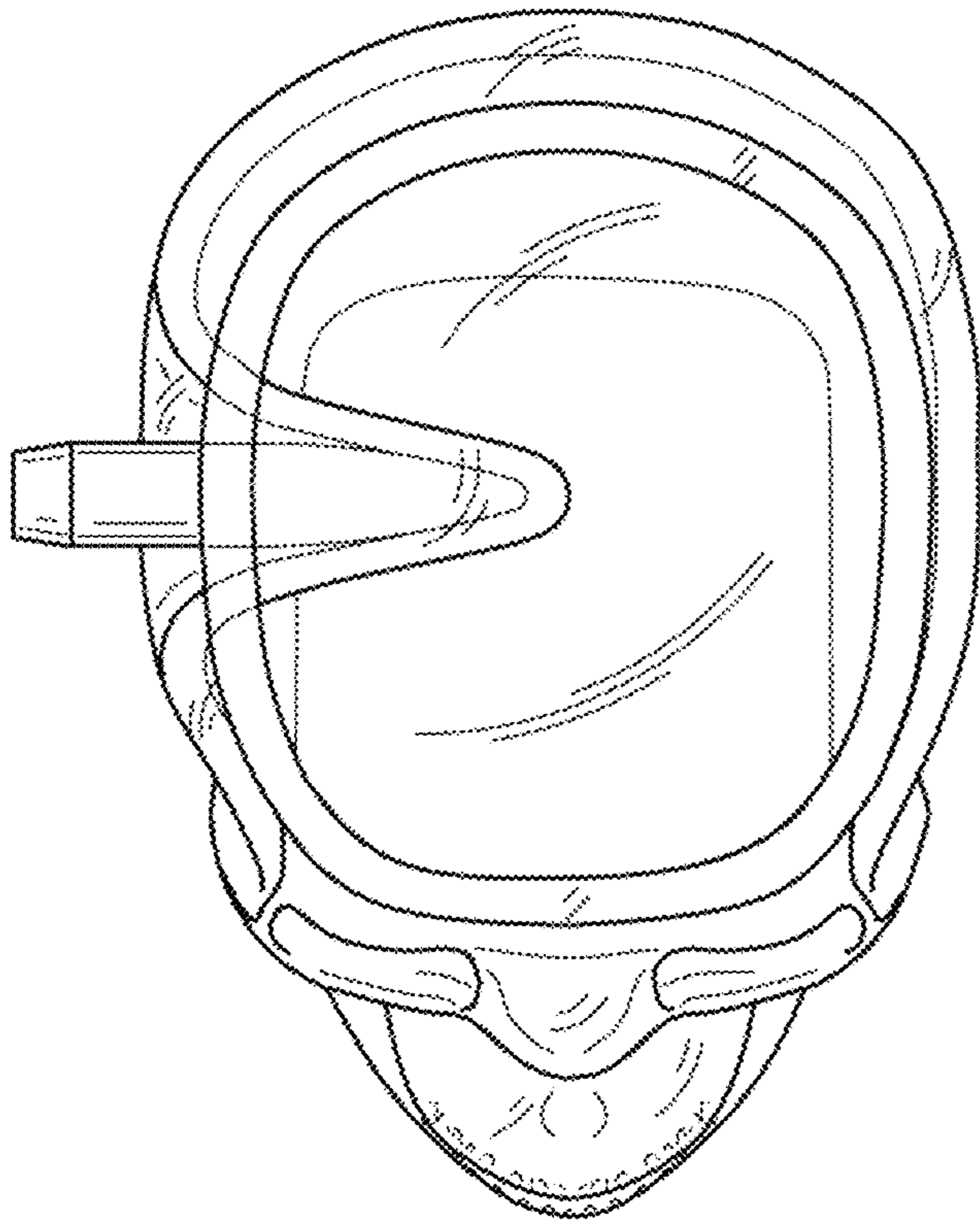

FIG. 7

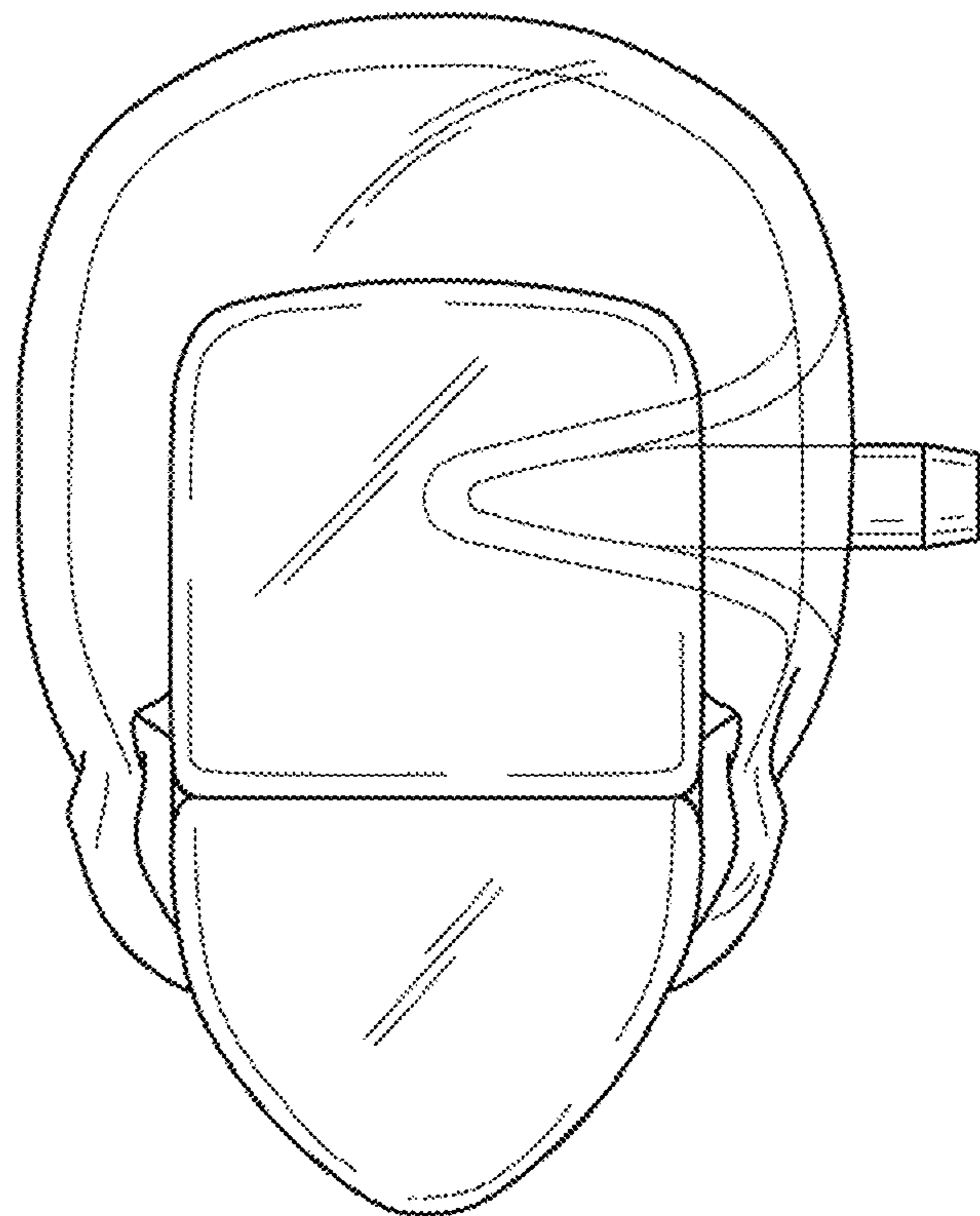

FIG. 8

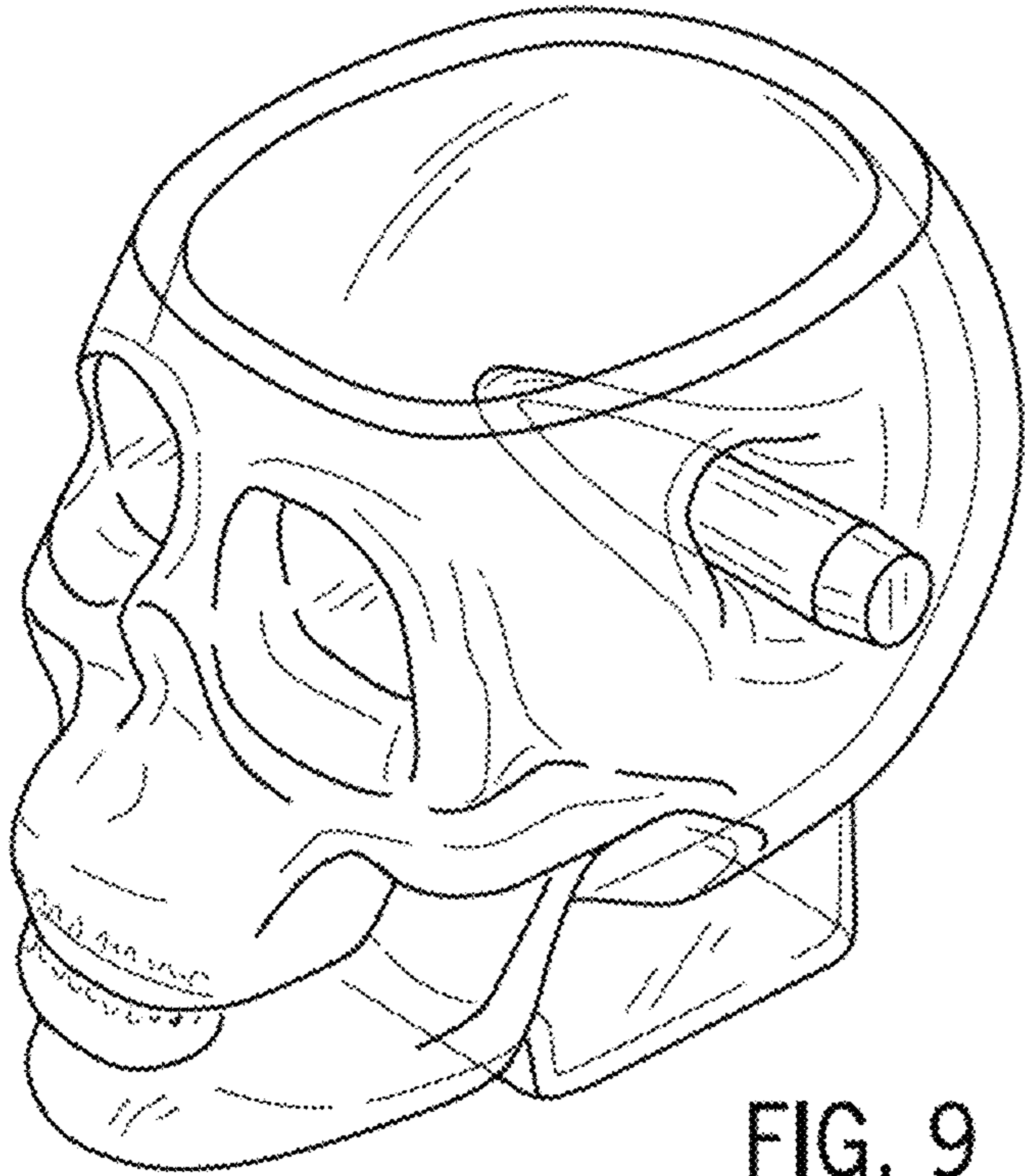

FIG. 9

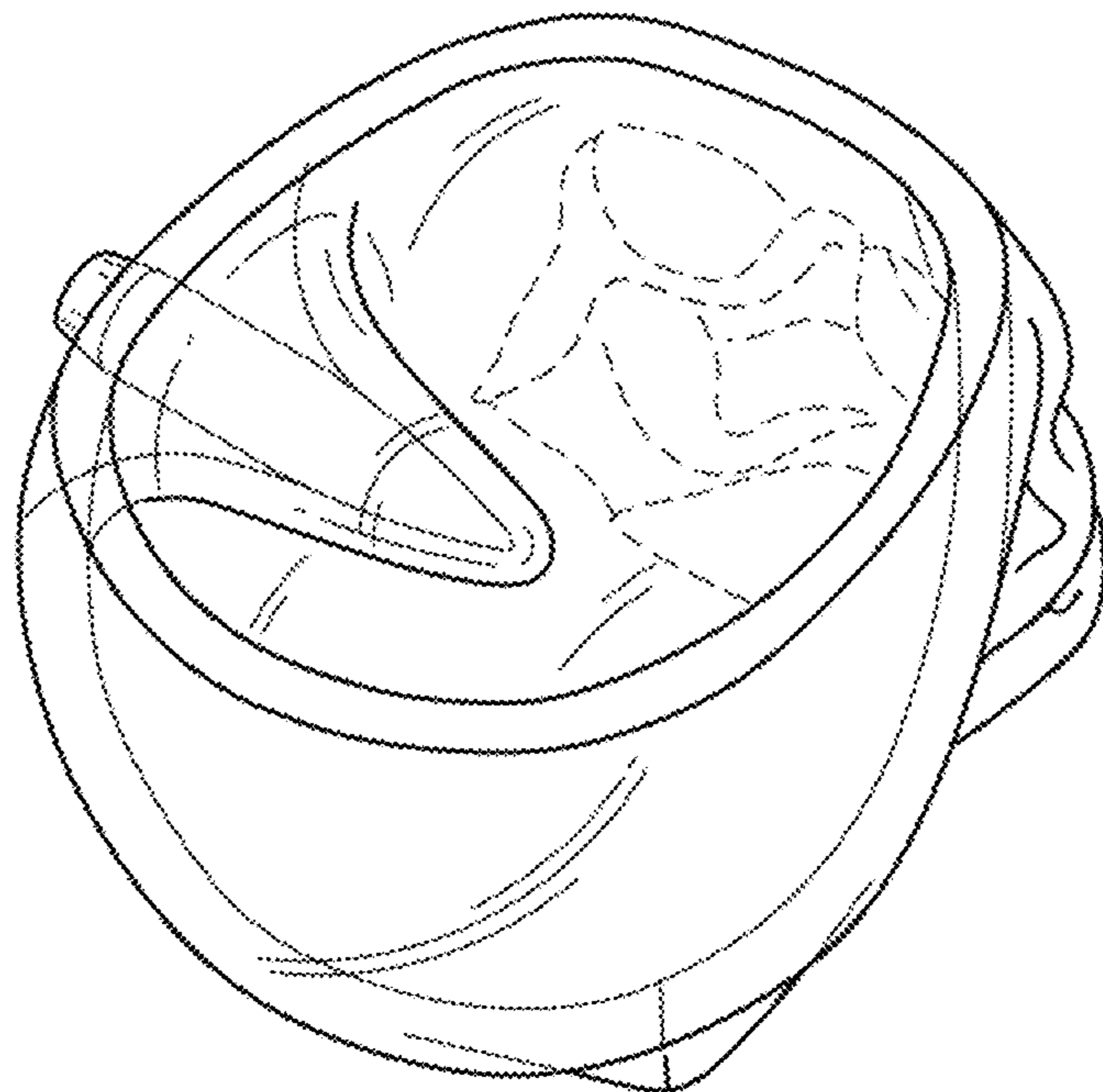

FIG. 10

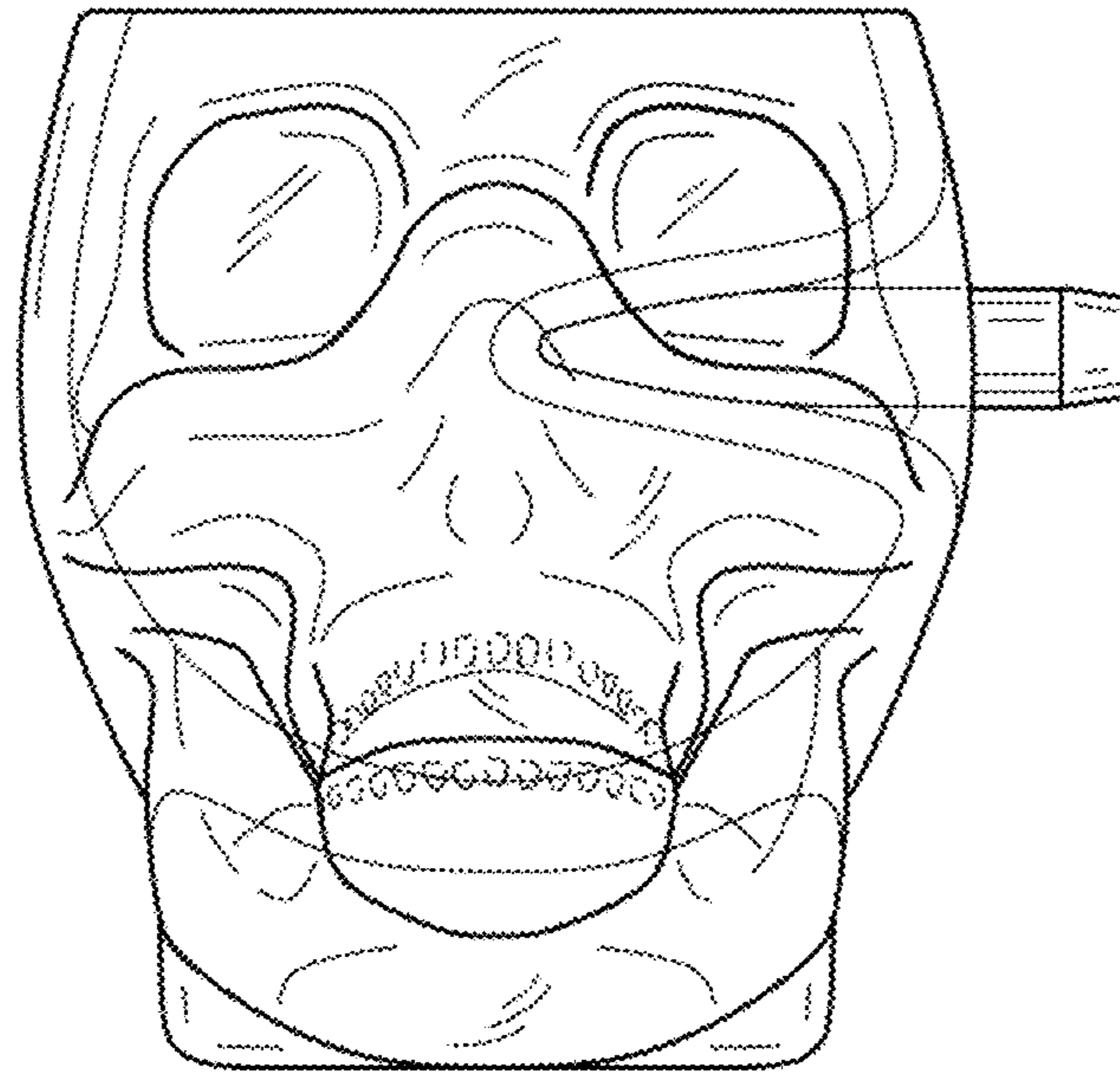

FIG. 11

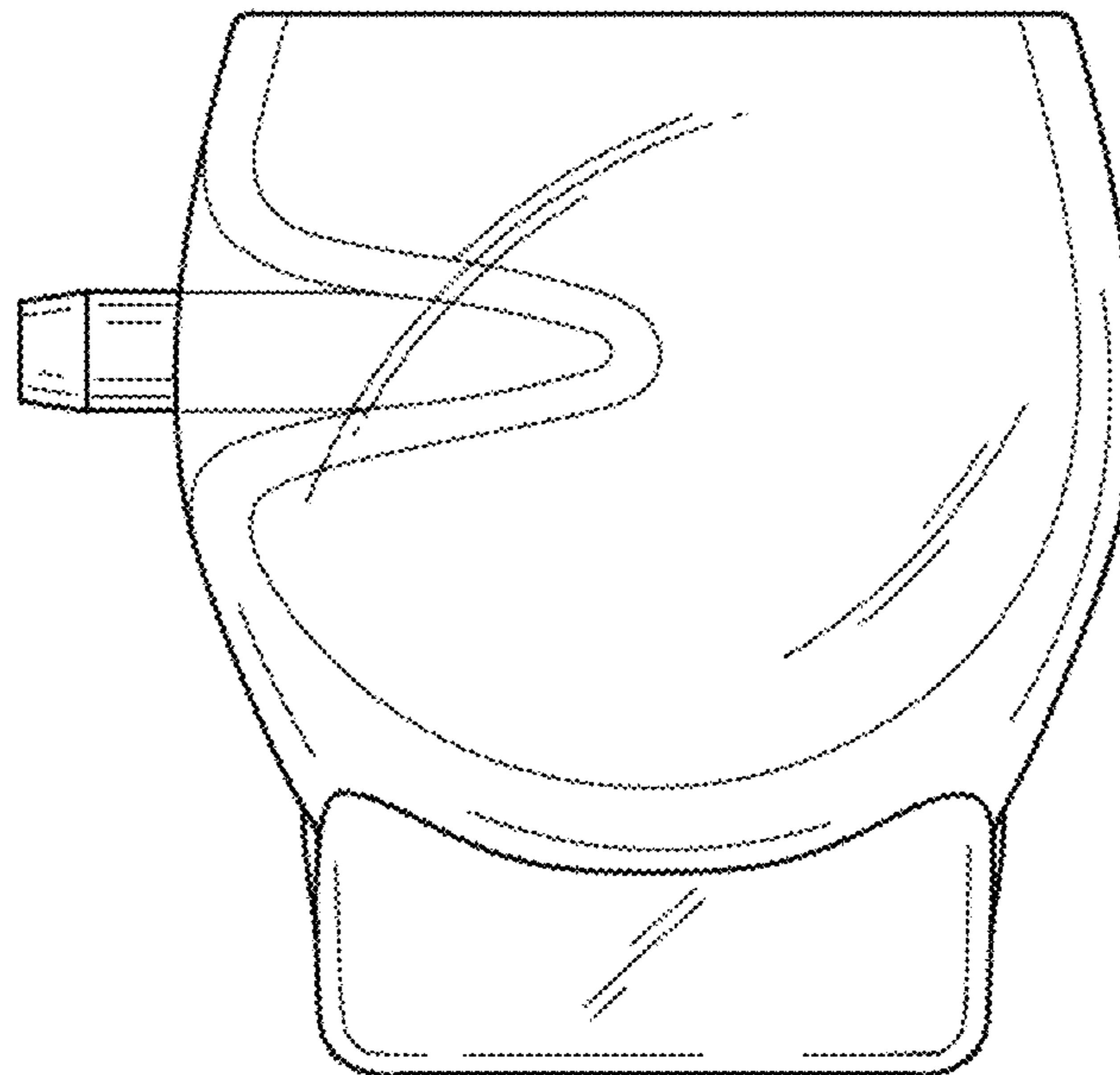

FIG. 12

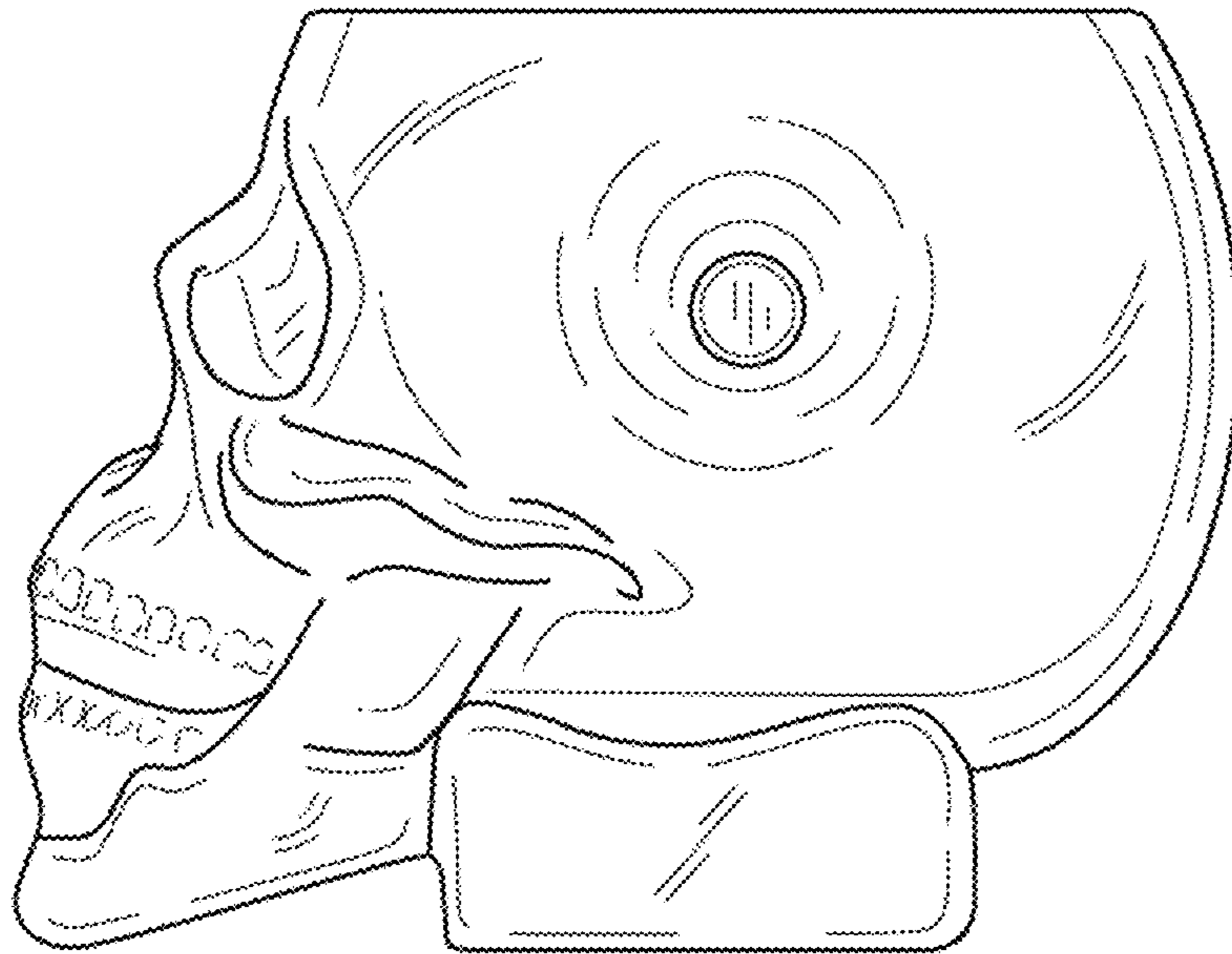

FIG. 13

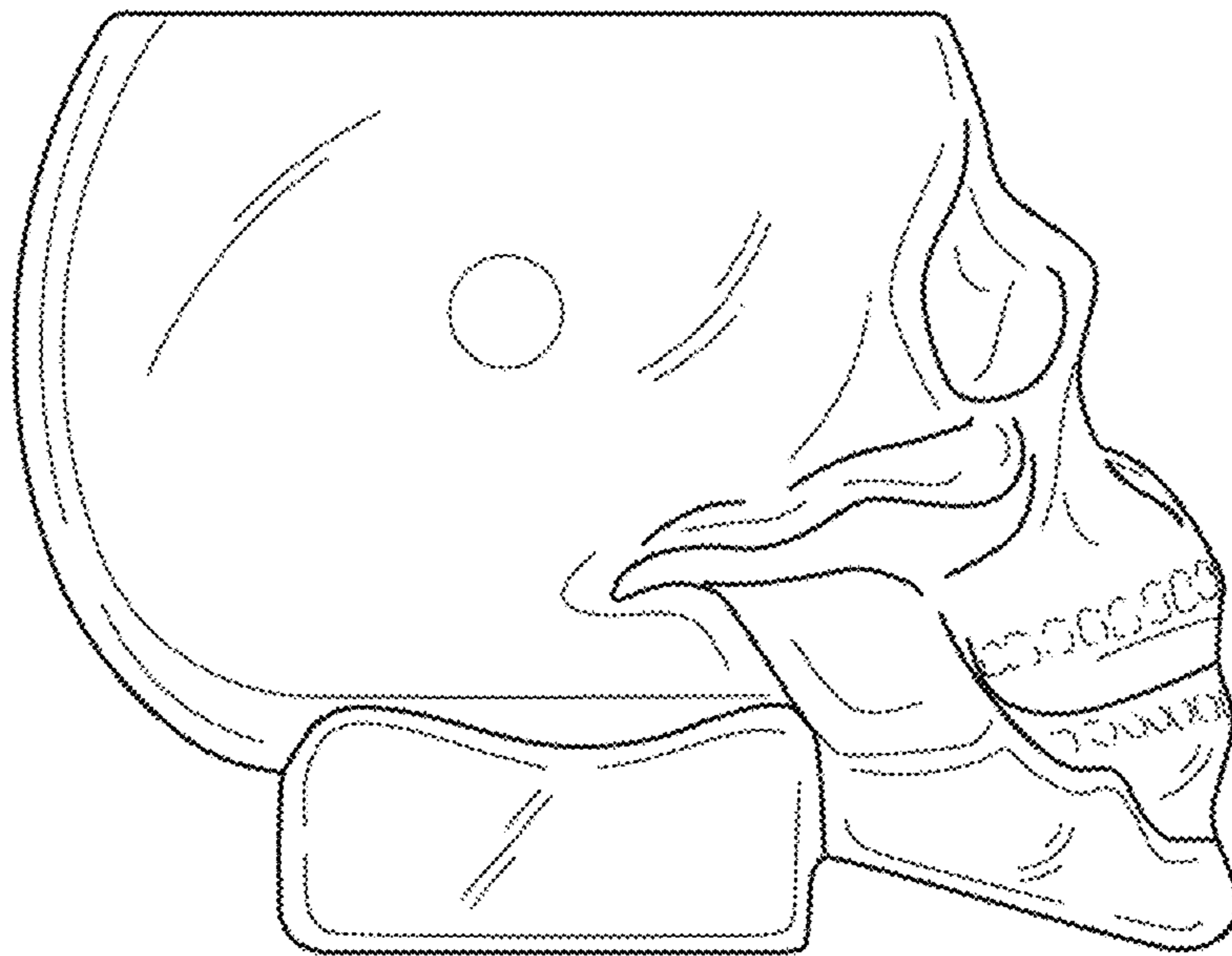

FIG. 14

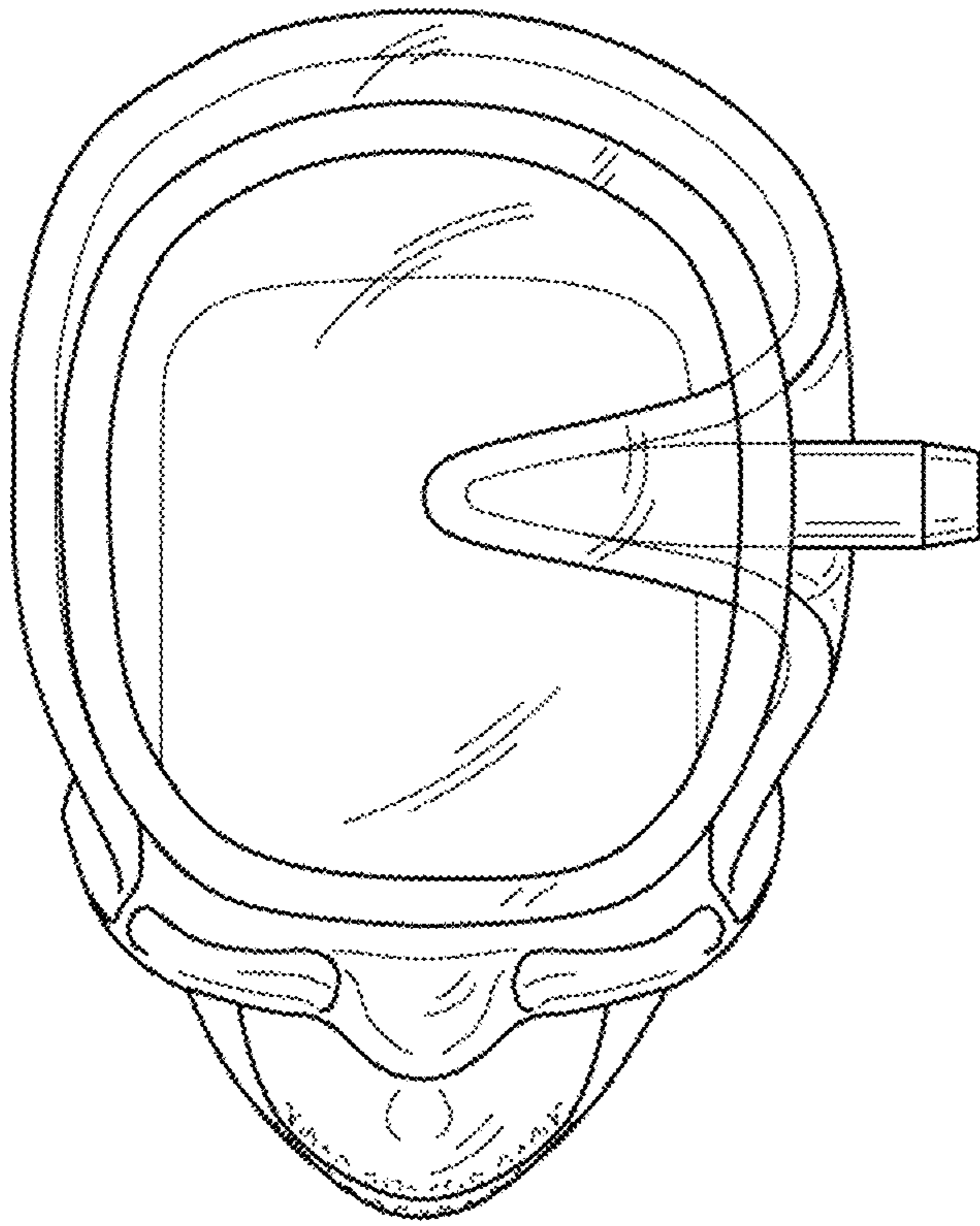

FIG. 15

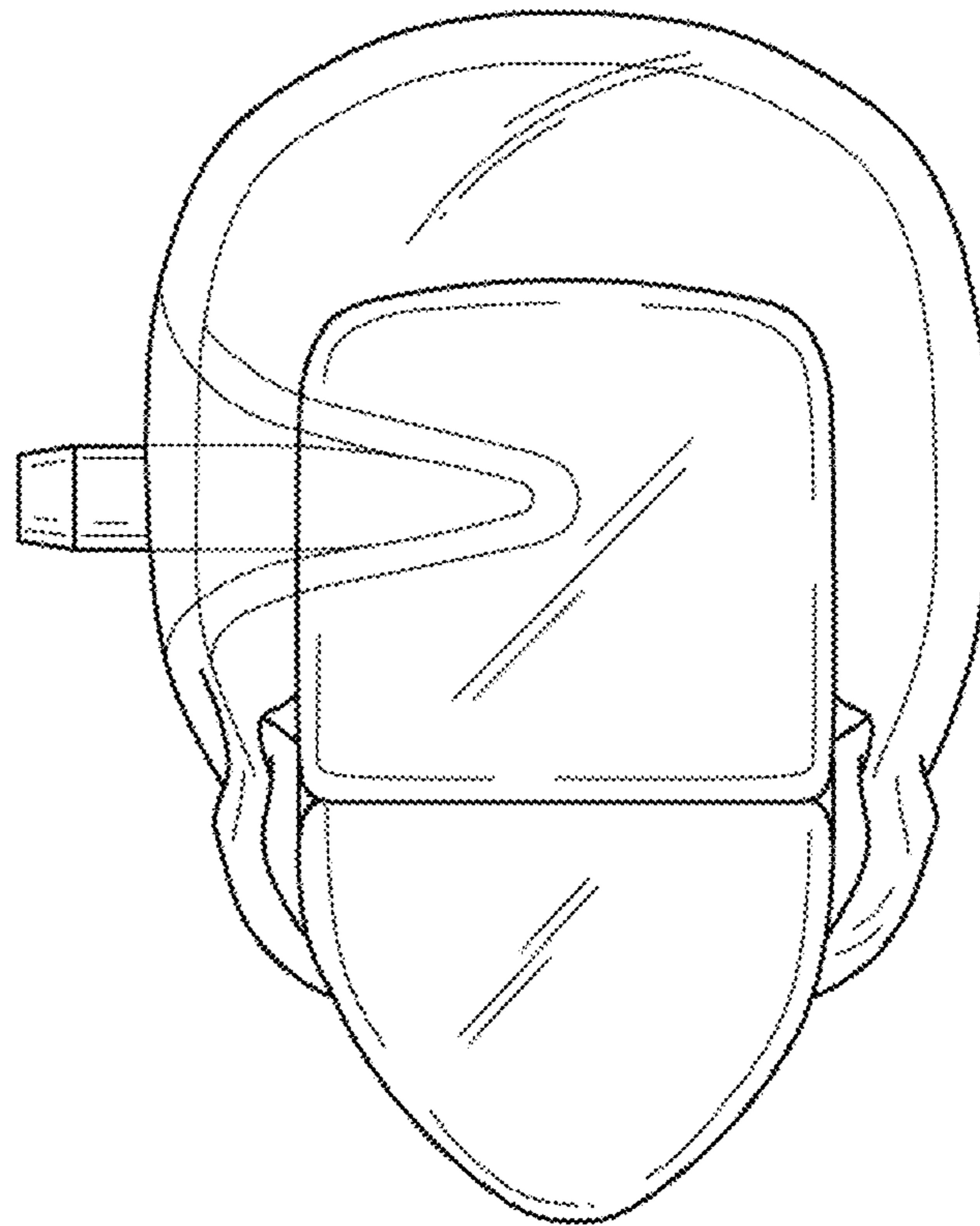

FIG. 16