



US00D896585S

(12) **United States Design Patent** (10) **Patent No.:** **US D896,585 S**  
**Berberet et al.** (45) **Date of Patent:** **\*\* Sep. 22, 2020**

(54) **GAS GRATE**  
(71) Applicant: **WHIRLPOOL CORPORATION**,  
Benton Harbor, MI (US)  
(72) Inventors: **Suzanne M. Berberet**, St. Joseph, MI  
(US); **Michael C. Lah**, Benton Harbor,  
MI (US)  
(73) Assignee: **Whirlpool Corporation**, Benton  
Harbor, MI (US)

D383,355 S 9/1997 Uter  
D393,567 S 4/1998 Ashcraft et al.  
D393,774 S 4/1998 Ashcraft et al.  
D401,112 S 11/1998 Miller  
D427,487 S 7/2000 Holbrook  
D551,501 S \* 9/2007 Baldwin ..... D7/408  
D610,405 S \* 2/2010 McConnell ..... D7/409  
D651,464 S 1/2012 Funnell et al.  
D702,497 S \* 4/2014 Funnell, II ..... D7/408  
D704,509 S \* 5/2014 Funnell, II ..... D7/408  
D758,797 S 6/2016 Lee et al.  
D767,324 S \* 9/2016 Funnell, II ..... D7/345  
D790,905 S 7/2017 Sajjad et al.

(Continued)

(\*\*) Term: **15 Years**

*Primary Examiner* — Susan E Krakower

(21) Appl. No.: **29/641,020**

*Assistant Examiner* — Andrew Kerr

(22) Filed: **Mar. 19, 2018**

(74) *Attorney, Agent, or Firm* — Price Heneveld LLP

(51) **LOC (12) Cl.** ..... **07-99**

(57) **CLAIM**

(52) **U.S. Cl.**  
USPC ..... **D7/408**

We claim the ornamental design for a gas grate, as shown and described.

(58) **Field of Classification Search**  
USPC ..... D7/339–341, 346, 347, 362, 402,  
D7/407–409; D23/397, 402  
CPC ..... F24C 15/107; F24C 15/36; F24C 3/08;  
F24C 3/082; F24C 7/067; F24C 7/062;  
A47J 37/0709  
See application file for complete search history.

**DESCRIPTION**

(56) **References Cited**

FIG. 1 is a top perspective view of a gas grate of the present disclosure;  
FIG. 2 is a first side elevational view of the gas grate of FIG. 1;  
FIG. 3 is a second side elevational view of the gas grate of FIG. 1;  
FIG. 4 is a third side elevational view of the gas grate of FIG. 1;  
FIG. 5 is a fourth side elevational view of the gas grate of FIG. 1;  
FIG. 6 is a top plan view of the gas grate of FIG. 1;  
FIG. 7 is a bottom plan view of the gas grate of FIG. 1; and,  
FIG. 8 is a bottom perspective view of the gas grate of FIG. 1.  
The broken lines depict portions of the article that form no part of the claimed design.

U.S. PATENT DOCUMENTS

D251,106 S 2/1979 Petursson  
D282,139 S 1/1986 Radford  
D293,069 S 12/1987 Cerola  
D293,070 S 12/1987 Cerola  
D303,605 S 9/1989 Davis et al.  
D343,989 S 2/1994 Falk  
D346,306 S 4/1994 Falk  
D361,015 S 8/1995 Doty et al.  
D364,535 S 11/1995 Moore  
D369,062 S 4/1996 Holbrook, Jr.  
D378,885 S 4/1997 Sparks

**1 Claim, 5 Drawing Sheets**

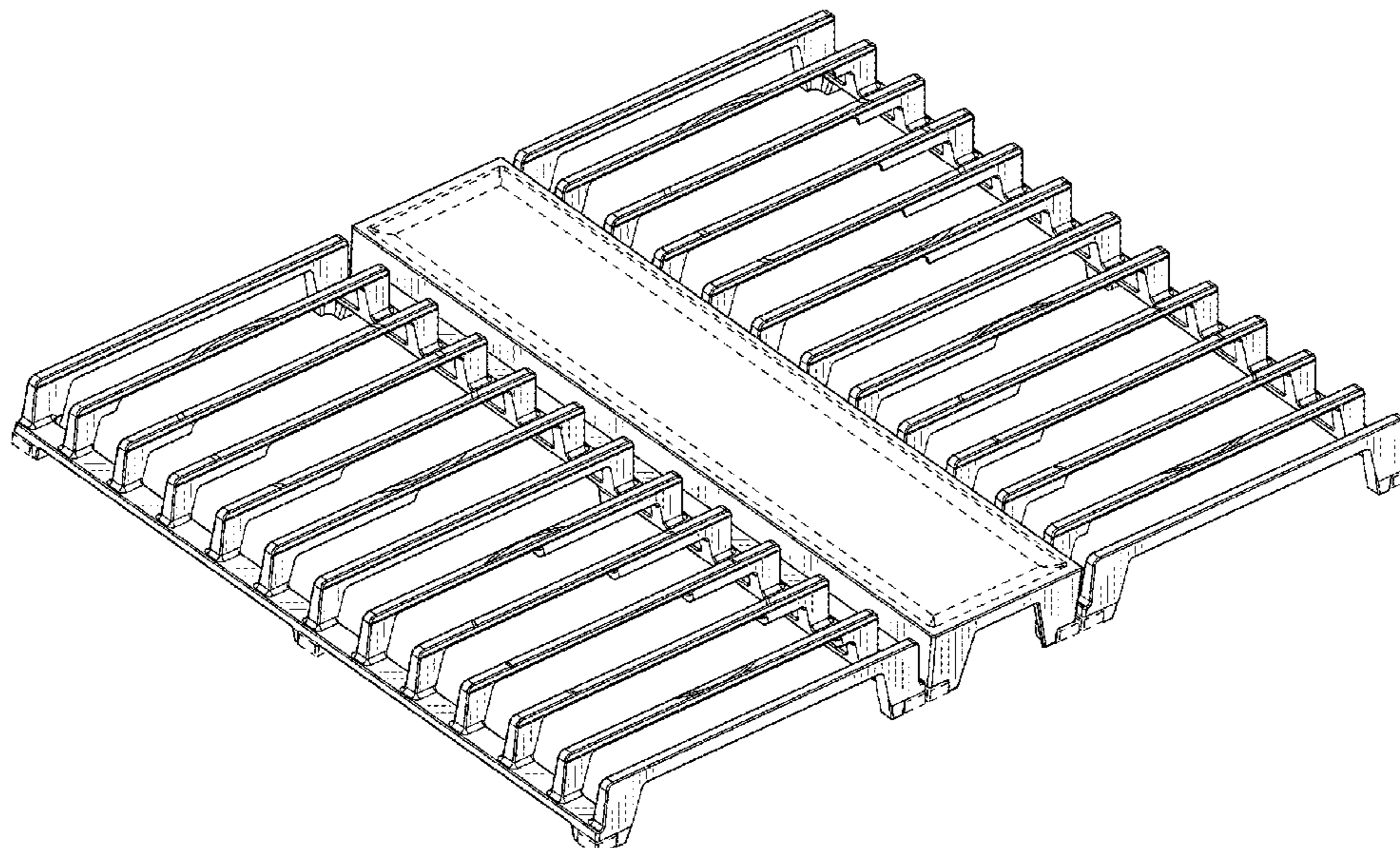

(56)

**References Cited**

U.S. PATENT DOCUMENTS

D812,425 S \* 3/2018 Reischmann ..... D7/409  
D840,752 S \* 2/2019 Kamper ..... D7/408  
D852,581 S \* 7/2019 Hackley ..... D7/409  
2003/0022052 A1\* 1/2003 Kearl ..... H01M 8/0204  
429/423  
2008/0264404 A1\* 10/2008 Hoyles ..... A47J 37/0709  
126/25 R  
2010/0199967 A1\* 8/2010 Wiczorek ..... A47J 37/0704  
126/25 R

\* cited by examiner



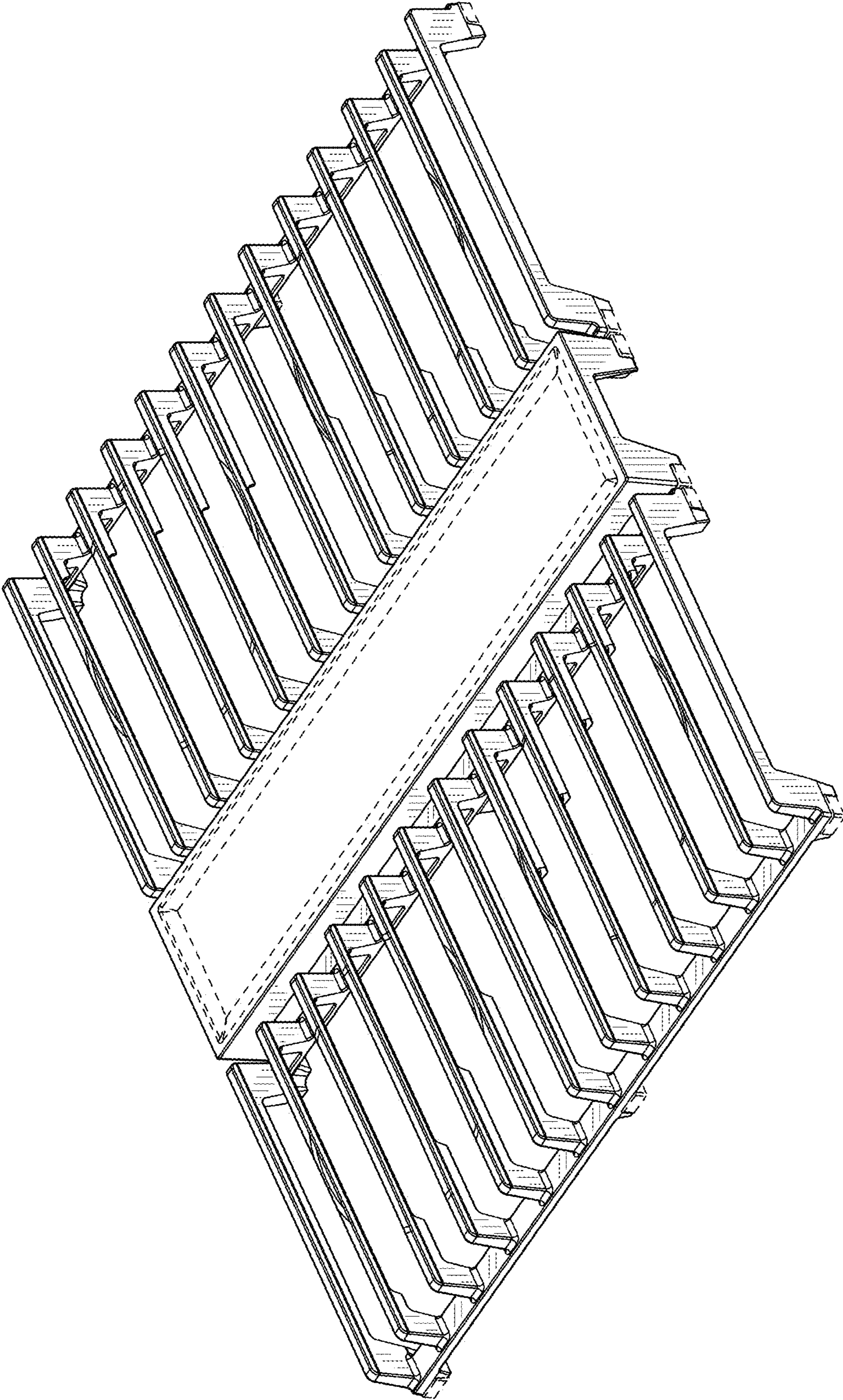

FIG. 1

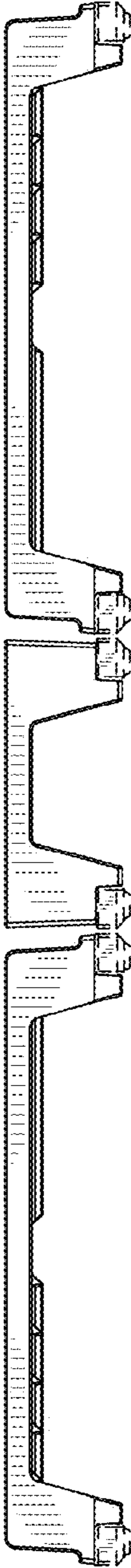

FIG. 2

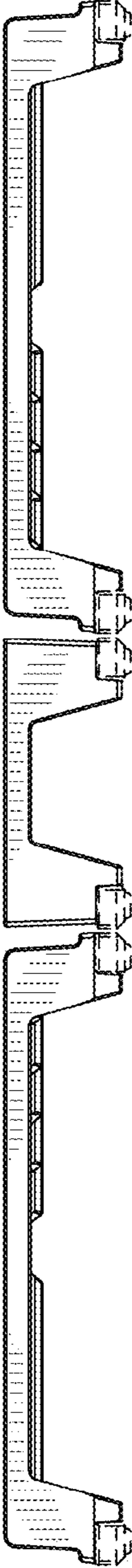

FIG. 3

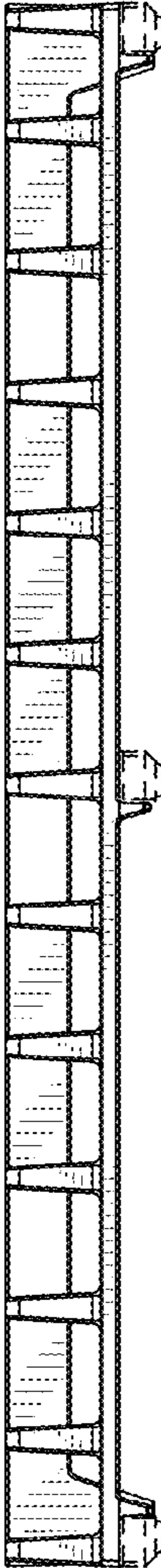

FIG. 4

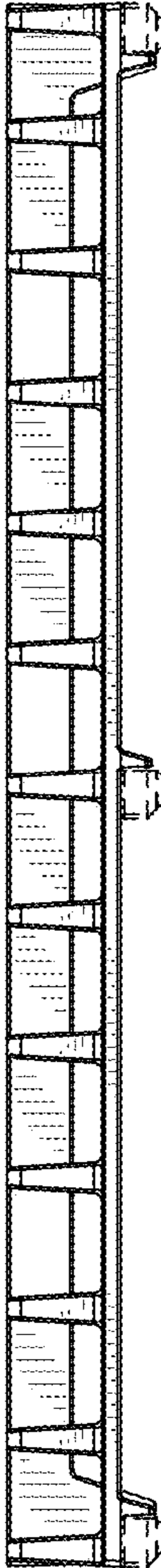

FIG. 5



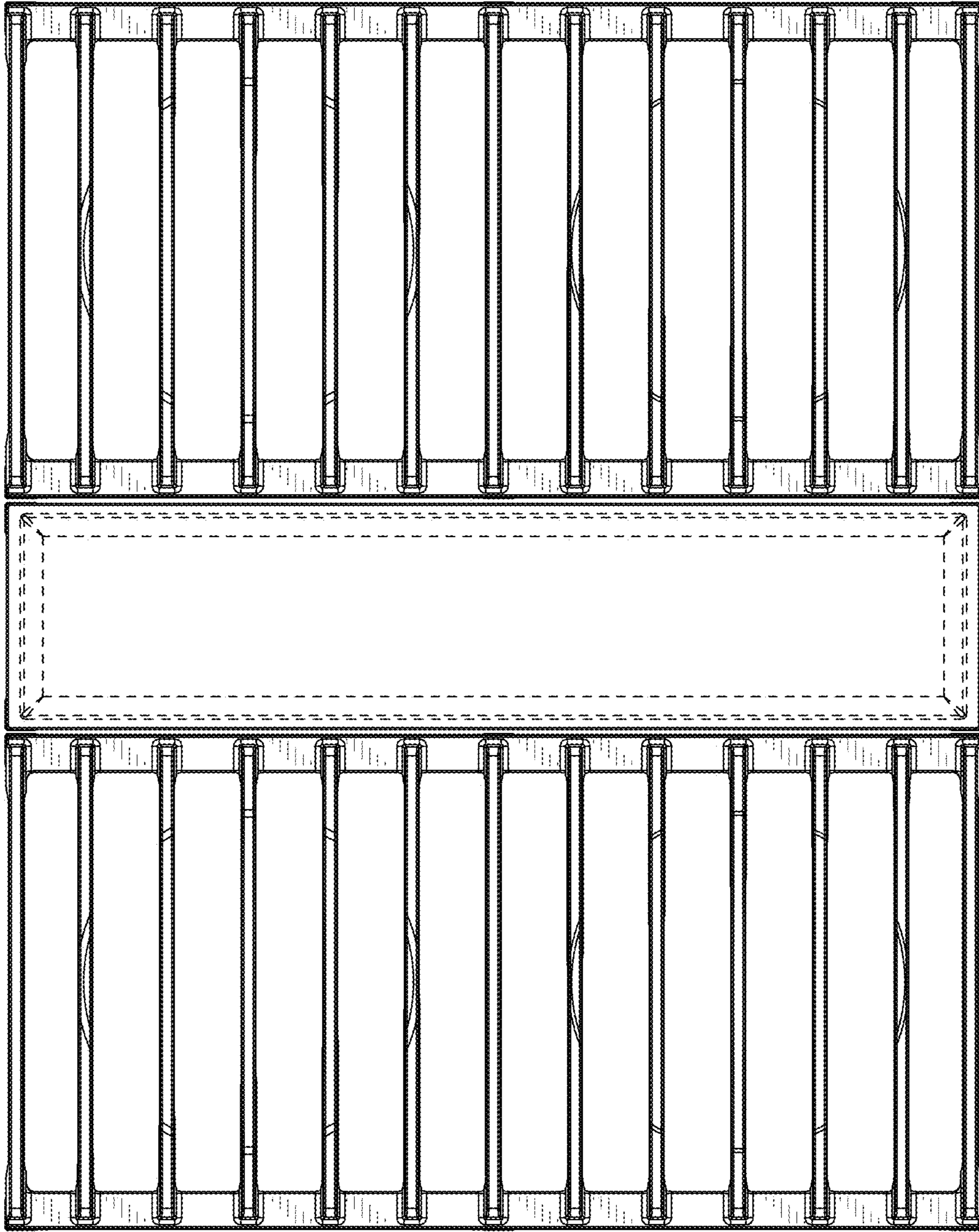

FIG. 6

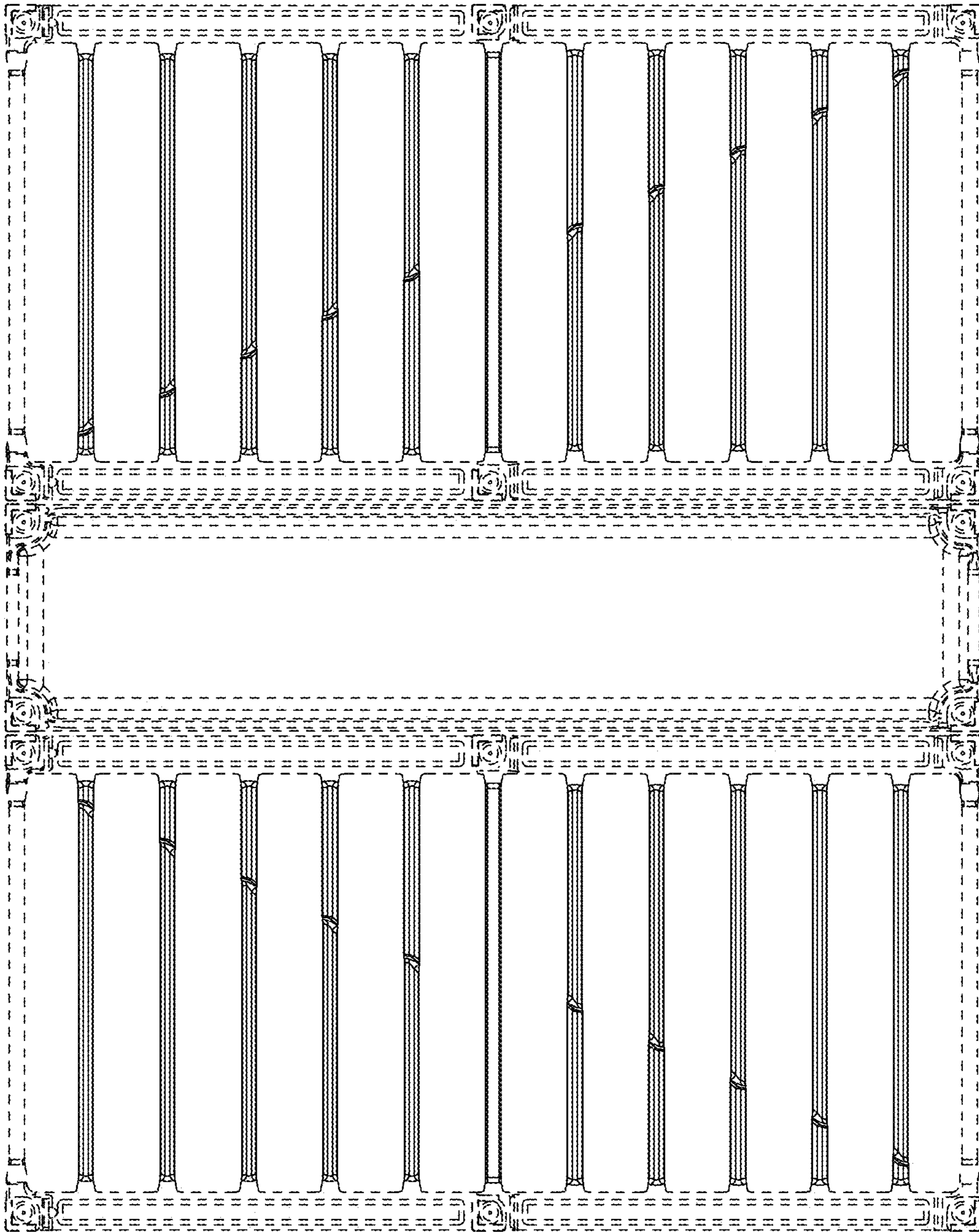

FIG. 7



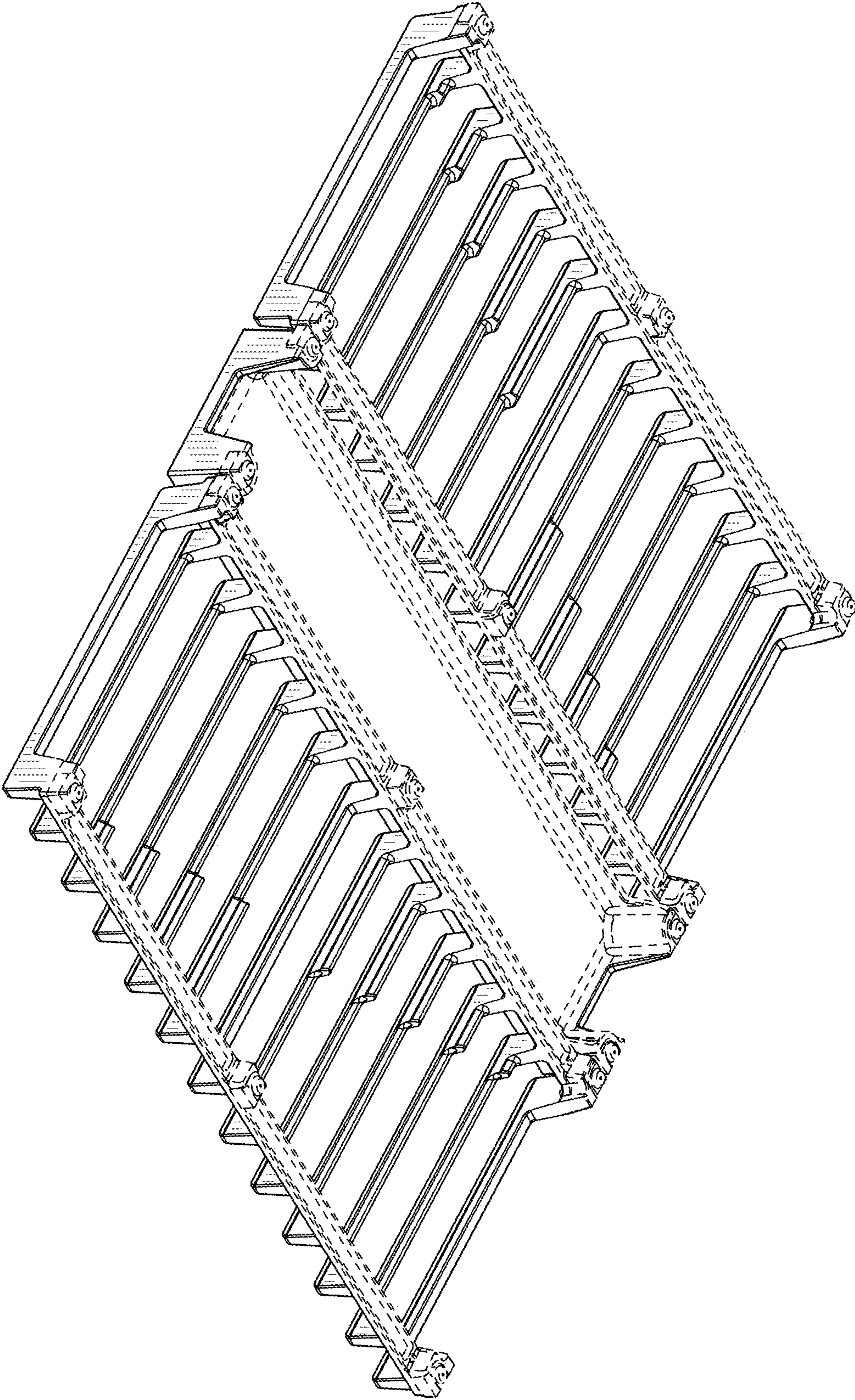

FIG. 8