



US00D896531S

(12) **United States Design Patent** (10) **Patent No.:** **US D896,531 S**
Lai (45) **Date of Patent:** **** Sep. 22, 2020**

(54) **DETANGLING BRUSH**
(71) Applicant: **Yuan Tao Lai**, Zhanjiang (CN)
(72) Inventor: **Yuan Tao Lai**, Zhanjiang (CN)
(**) Term: **15 Years**
(21) Appl. No.: **29/736,904**
(22) Filed: **Jun. 3, 2020**
(51) **LOC (12) Cl.** **04-02**
(52) **U.S. Cl.**
USPC **D4/134**
(58) **Field of Classification Search**
USPC D4/104, 105, 106, 107, 108, 109, 110,
D4/111, 112, 113, 117, 121, 130, 132,
D4/133, 134, 135, 136, 138, 199; 15/201
CPC A46B 5/002; A46B 5/0025; A46B 5/0033;
A46B 5/0037; A46B 5/02; A46B 9/023;
A46B 15/0087; A46B 2200/104
See application file for complete search history.

(56) **References Cited**

U.S. PATENT DOCUMENTS

D26,973 S * 4/1897 Shepherd D4/134
825,910 A * 7/1906 Kleinsorgen A46B 7/06
15/201
1,367,385 A * 2/1921 Harrison A46B 5/0075
15/202
D88,805 S * 12/1932 MacInnis D4/134
D96,072 S * 6/1935 Wewetzer D4/134
2,796,620 A * 6/1957 Bressler A46B 5/0025
15/201
D358,489 S * 5/1995 Balster D4/134
D452,079 S * 12/2001 Ping D4/104
D488,621 S * 4/2004 Wong D4/104
D566,402 S * 4/2008 Neuner D4/136
D568,612 S * 5/2008 Chan D4/120
8,627,537 B2 * 1/2014 Mercier A46B 9/028
15/160

D750,896 S * 3/2016 Park D4/136
D767,283 S 9/2016 Mishan
D784,705 S 4/2017 York

OTHER PUBLICATIONS

Video review of detangling hairbrush by ©AberMaria101 [on-line].
[Published Oct. 18, 2019.] URL: >https://www.youtube.com/watch?v=sTam5LJGdkc< (Year: 2019).*
Screen captures from video review of detangling hairbrush by ©AmberMaria101 [on-line]. [Published Oct. 18, 2019.] [Retrieved from the Internet Aug. 7, 2020. URL: >https://www.youtube.com/watch?v=sTam5LJGdkc< (Year: 2019).*
Eight-claw Comb™ Quick Detangle Brush [on-line]. [First availability date unknown.] [Retrieved from the Internet Aug. 6, 2020.] URL: >https://www.depotnation.co/products/eight-claw-comb-quick-detangle-brush< (Year: 2020).*
Eight-Claw Comb Hair Soft Scalp Massage Brush Static Scalp Comb Dr Brush Women Detangle Hairbrush [on-line]. [First availability date unknown.] [Retrieved from the Internet Aug. 6, 2020.] for complete URL, see p. 8 of printed copy. (Year: 2020).*

* cited by examiner

Primary Examiner — Karen E Eldridge Powers

(57) **CLAIM**

The ornamental design for a detangling brush, as shown and described.

DESCRIPTION

FIG. 1 is a perspective view of a detangling brush showing my new design;
FIG. 2 is another perspective view thereof;
FIG. 3 is a front elevational view thereof;
FIG. 4 is a rear elevational view thereof;
FIG. 5 is a left side elevational view thereof;
FIG. 6 is a right side elevational view thereof;
FIG. 7 is a top plan view thereof; and,
FIG. 8 is a bottom plan view thereof.
The broken lines in the drawings depict portions of the detangling brush that form no part of the claimed design.

1 Claim, 8 Drawing Sheets

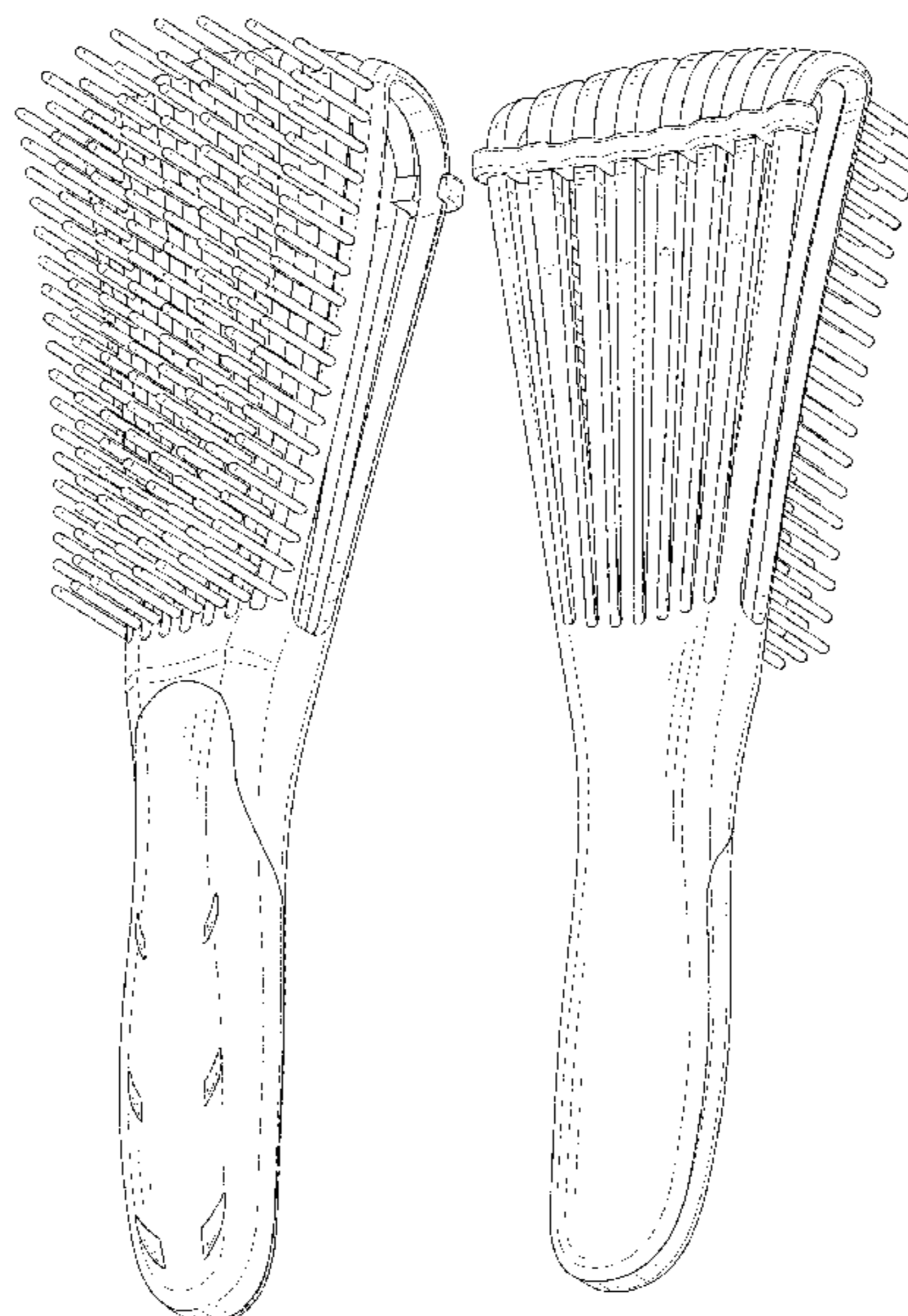

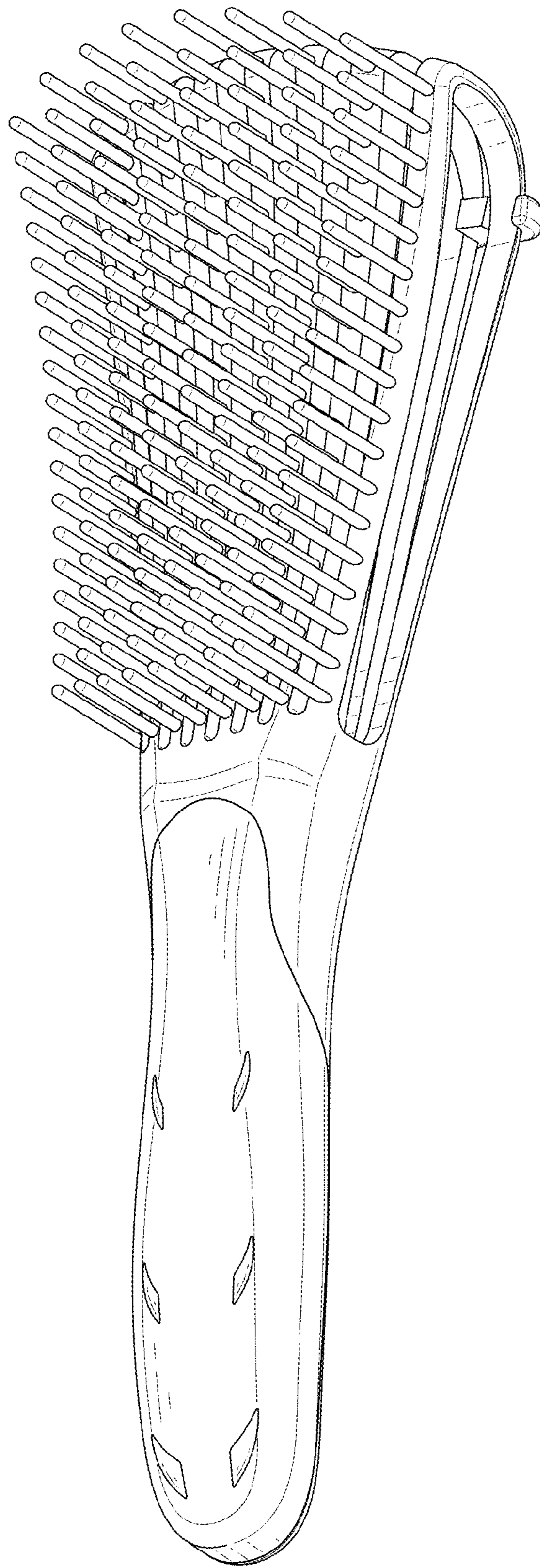

FIG. 1

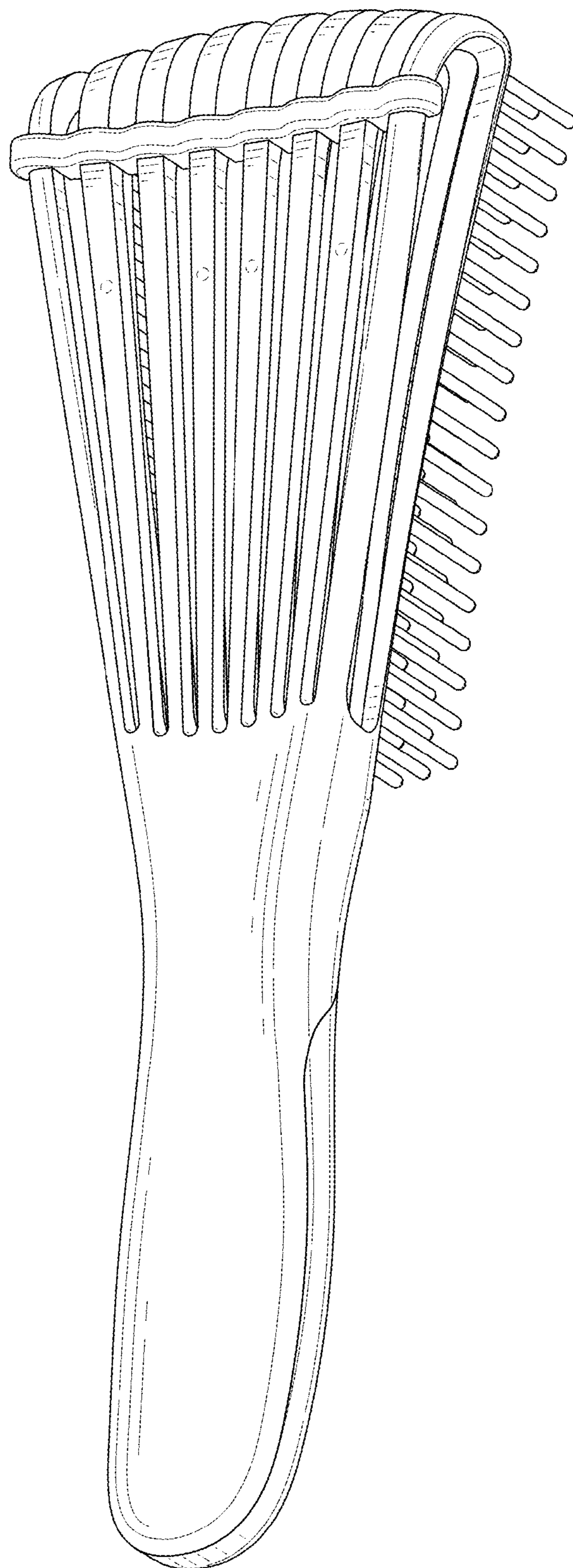

FIG. 2

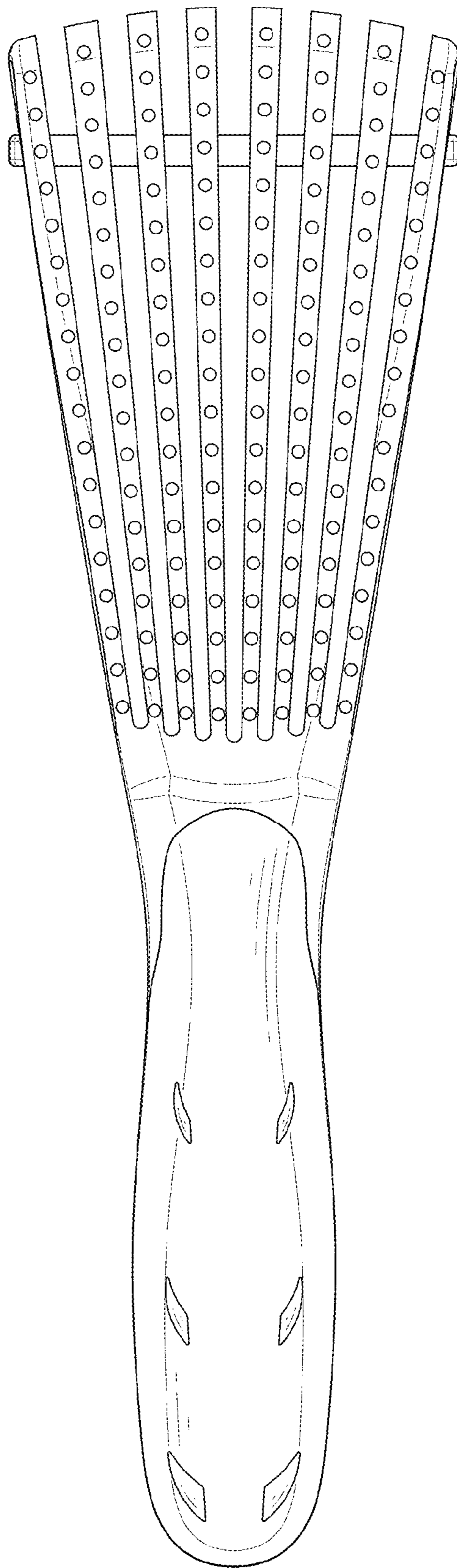

FIG. 3

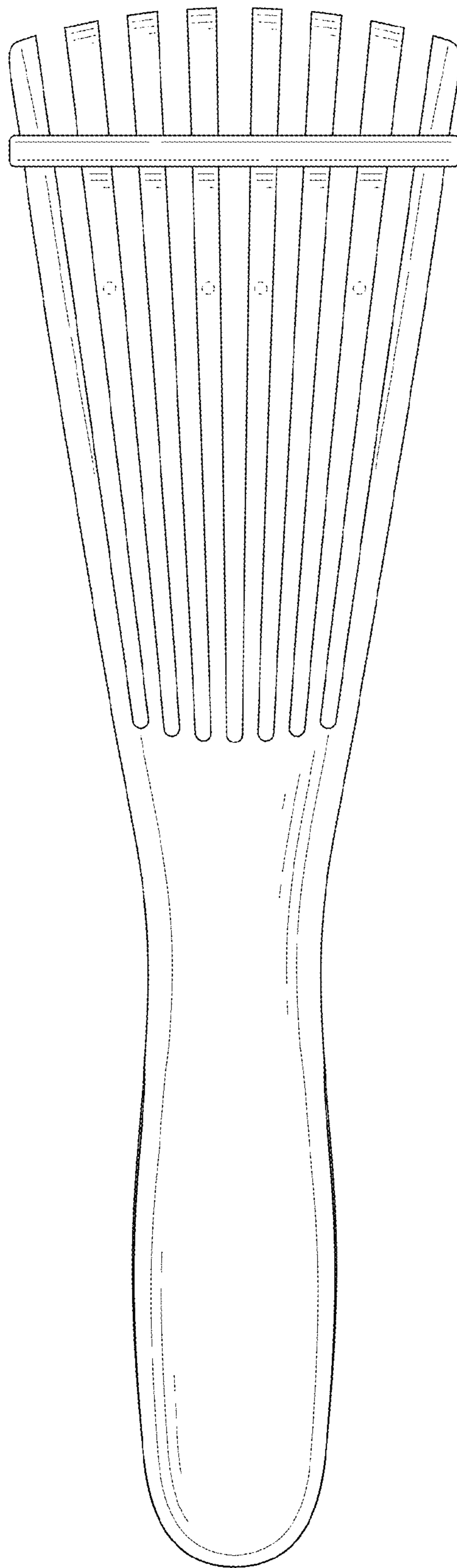

FIG. 4

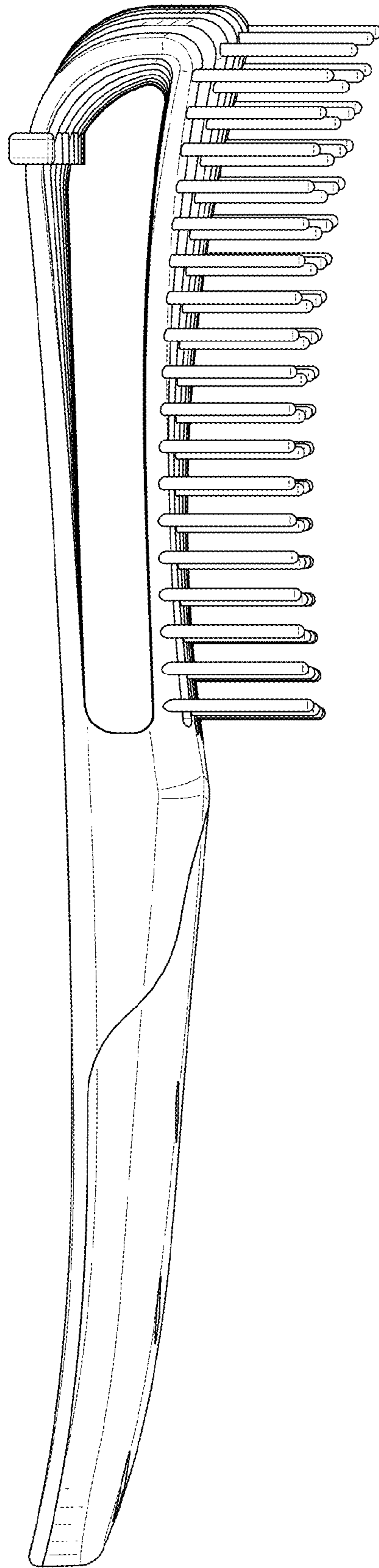

FIG. 5

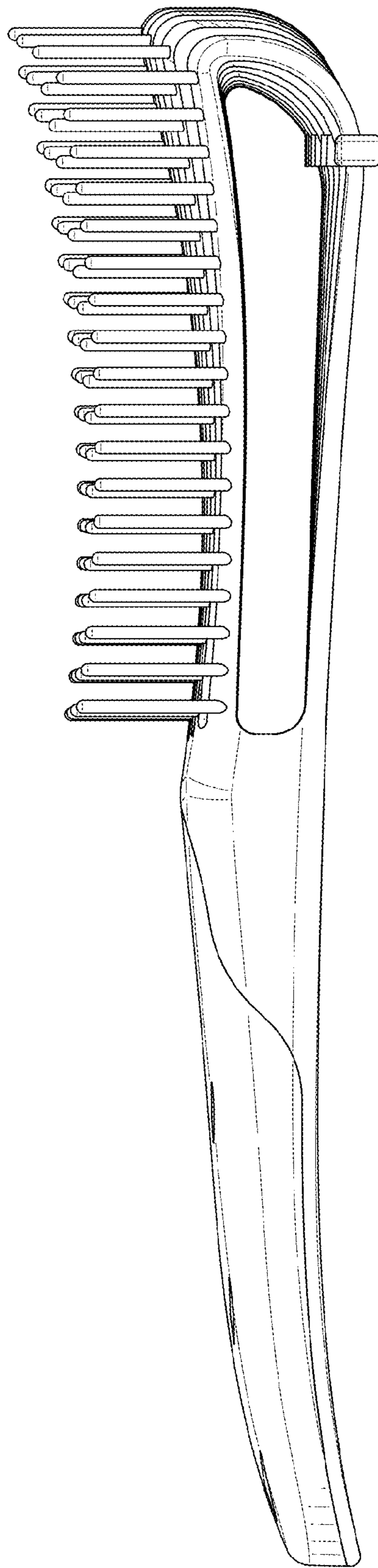

FIG. 6

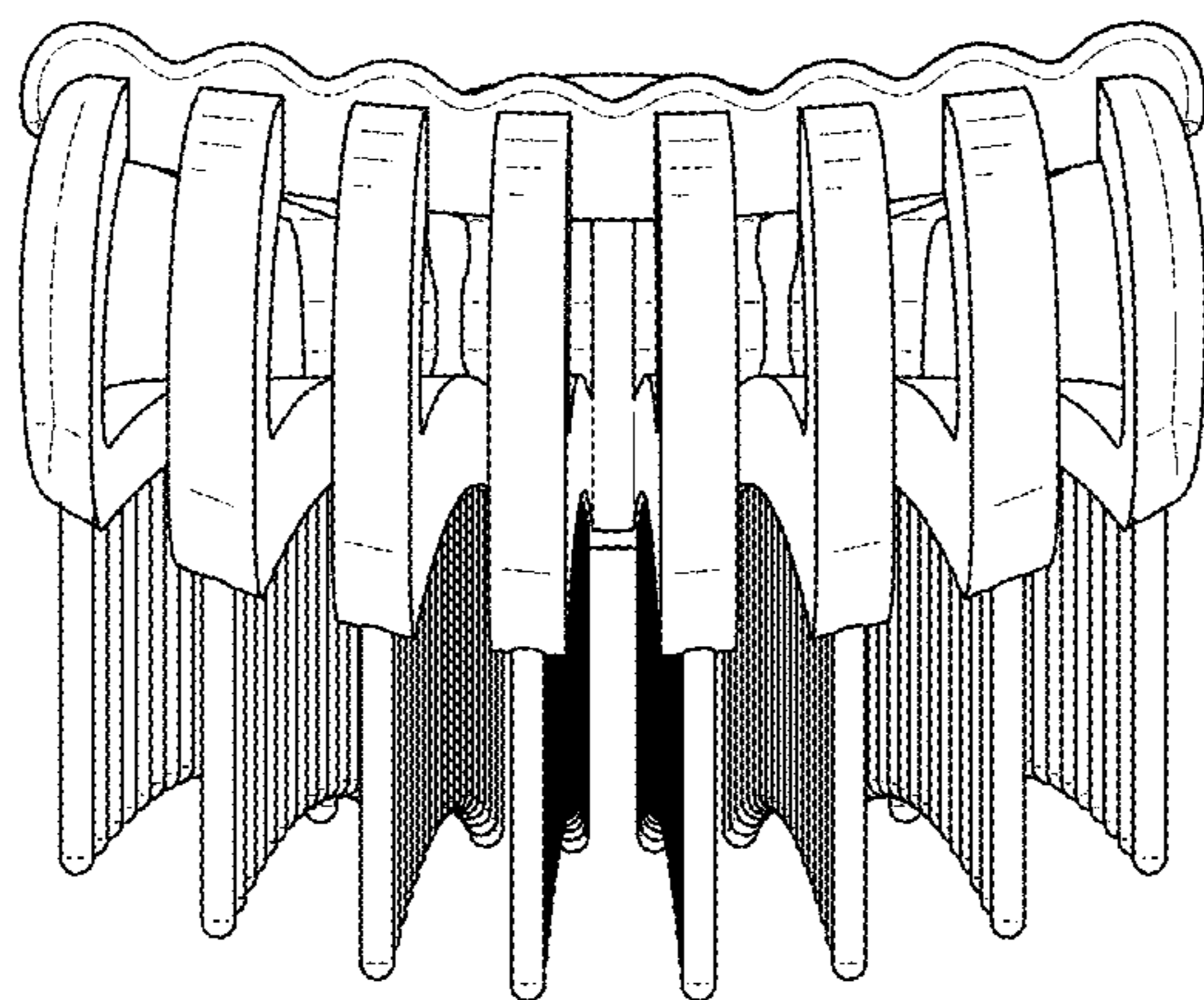

FIG. 7

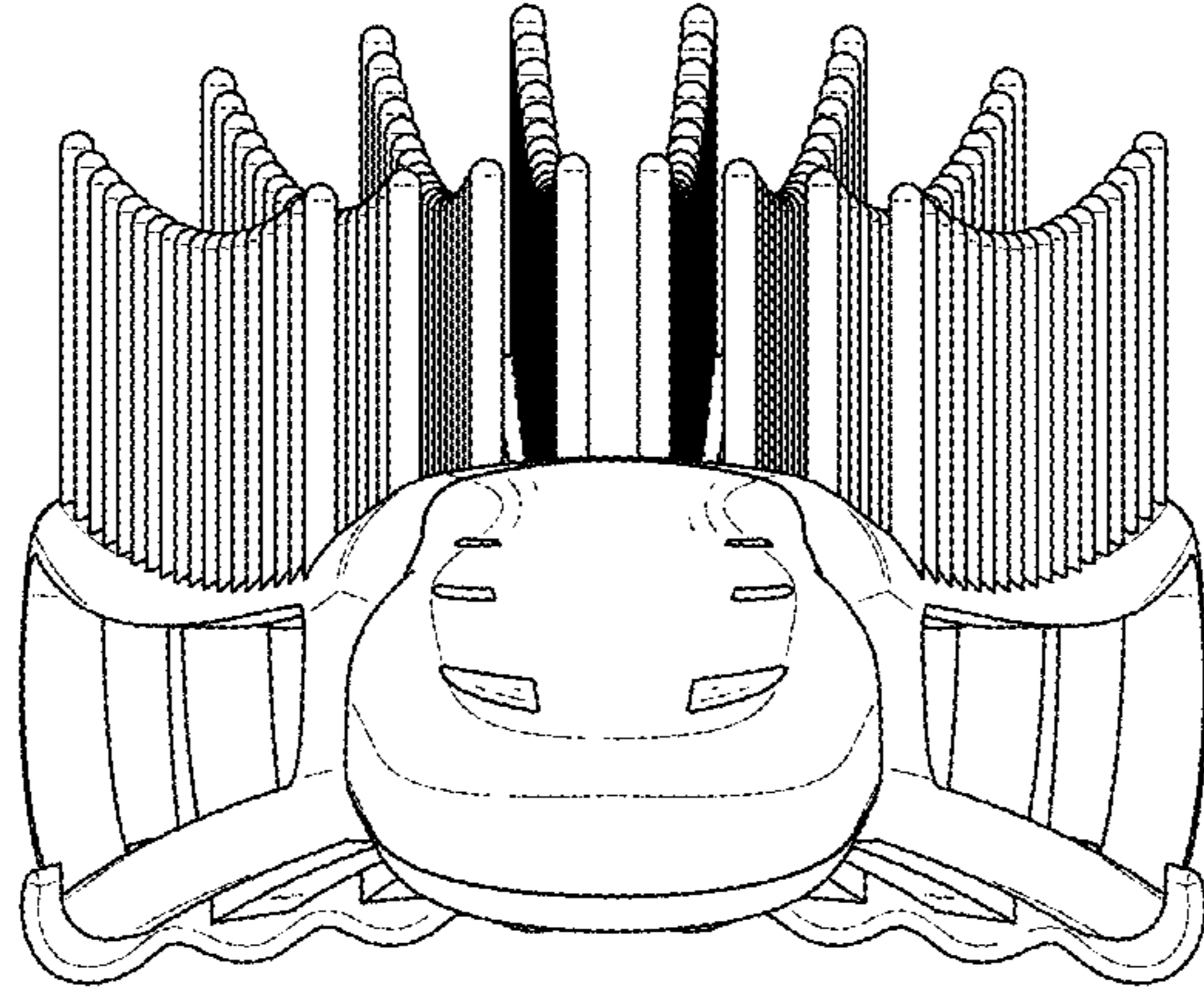

FIG. 8