



US00D896347S

(12) **United States Design Patent**
Lazarini et al.

(10) **Patent No.:** **US D896,347 S**

(45) **Date of Patent:** **** Sep. 15, 2020**

(54) **FAUCET**

(71) Applicant: **DELTA FAUCET COMPANY,**
Indianapolis, IN (US)

(72) Inventors: **Alejandra Lazarini,** Carmel, IN (US);
Song Qing Liao, Guangdong (CN)

(73) Assignee: **DELTA FAUCET COMPANY,**
Indianapolis, IN (US)

(**) Term: **15 Years**

(21) Appl. No.: **29/638,951**

(22) Filed: **Mar. 2, 2018**

(51) **LOC (12) Cl.** **23-01**

(52) **U.S. Cl.**
USPC **D23/238**

(58) **Field of Classification Search**
USPC D23/238, 241–243, 249–250, 252,
D23/254–255, 257; D8/307–308
CPC Y10T 137/9464; Y10T 137/6014; Y10T
137/6017
See application file for complete search history.

(56) **References Cited**

U.S. PATENT DOCUMENTS

D576,709 S * 9/2008 Fritz D23/238
D602,122 S * 10/2009 Corbett D23/238

D616,071 S * 5/2010 Fakonas D23/252
D651,287 S * 12/2011 Kwok D23/252
D655,790 S * 3/2012 Kwok D23/252
D656,590 S * 3/2012 Ko D23/257
8,156,963 B2 * 4/2012 Lopp E03C 1/0404
137/625.41
D676,938 S * 2/2013 Kwok D23/252
D687,126 S * 7/2013 Romero D23/238
D820,957 S * 6/2018 Schaubach D23/238
D874,614 S * 2/2020 Lazarini D23/238

* cited by examiner

Primary Examiner — Robert A Delehanty

(74) *Attorney, Agent, or Firm* — Nirav D. Parikh; Edgar
A. Zarins

(57) **CLAIM**

The ornamental design for a faucet, as shown and described.

DESCRIPTION

FIG. 1 is a front perspective view of a faucet showing our new design;
FIG. 2 is a rear perspective view thereof;
FIG. 3 is a front elevational view thereof;
FIG. 4 is a left side view thereof;
FIG. 5 is a rear view thereof;
FIG. 6 is a right side view thereof; and,
FIG. 7 is a top plan view thereof.

1 Claim, 4 Drawing Sheets

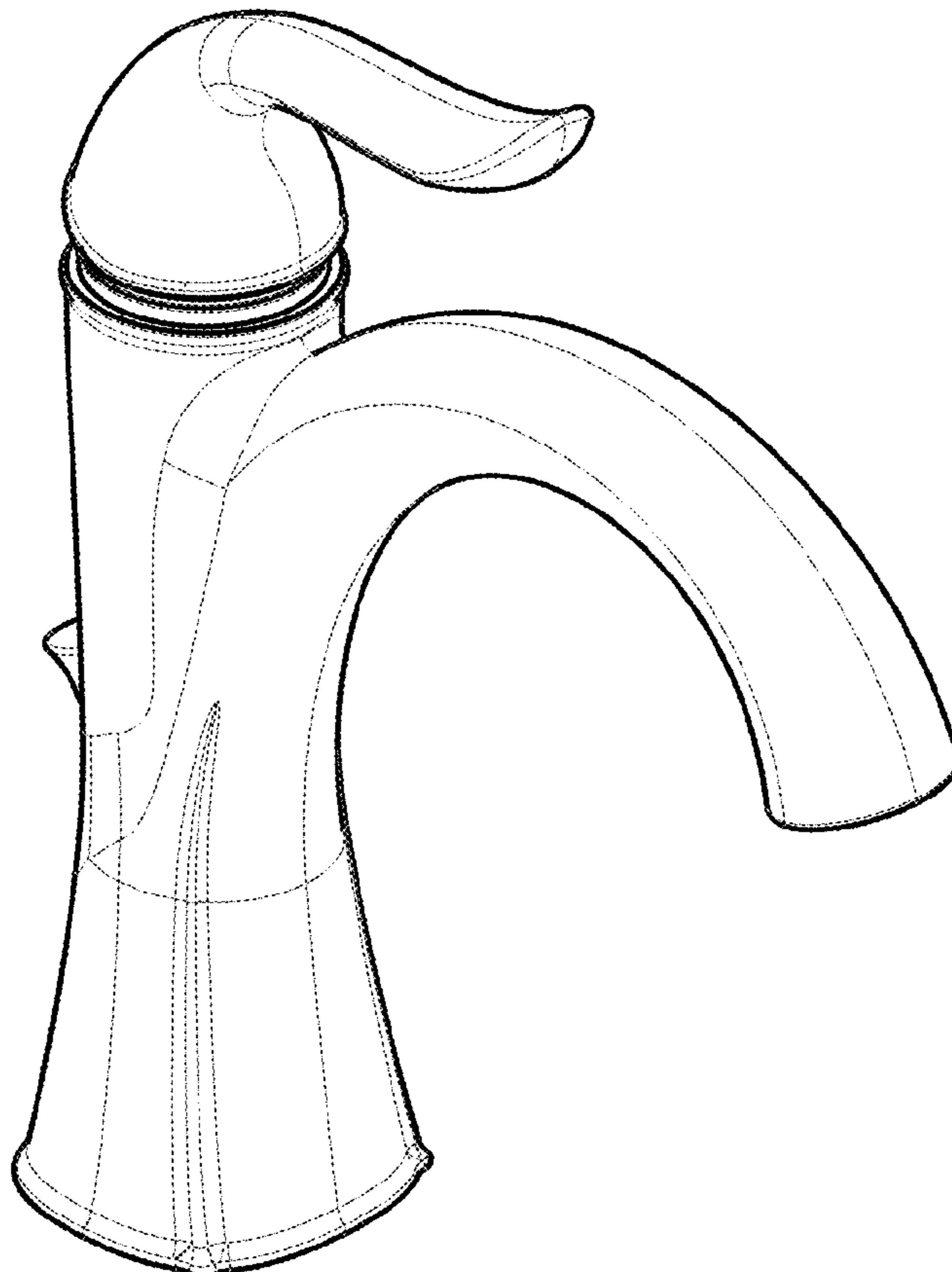

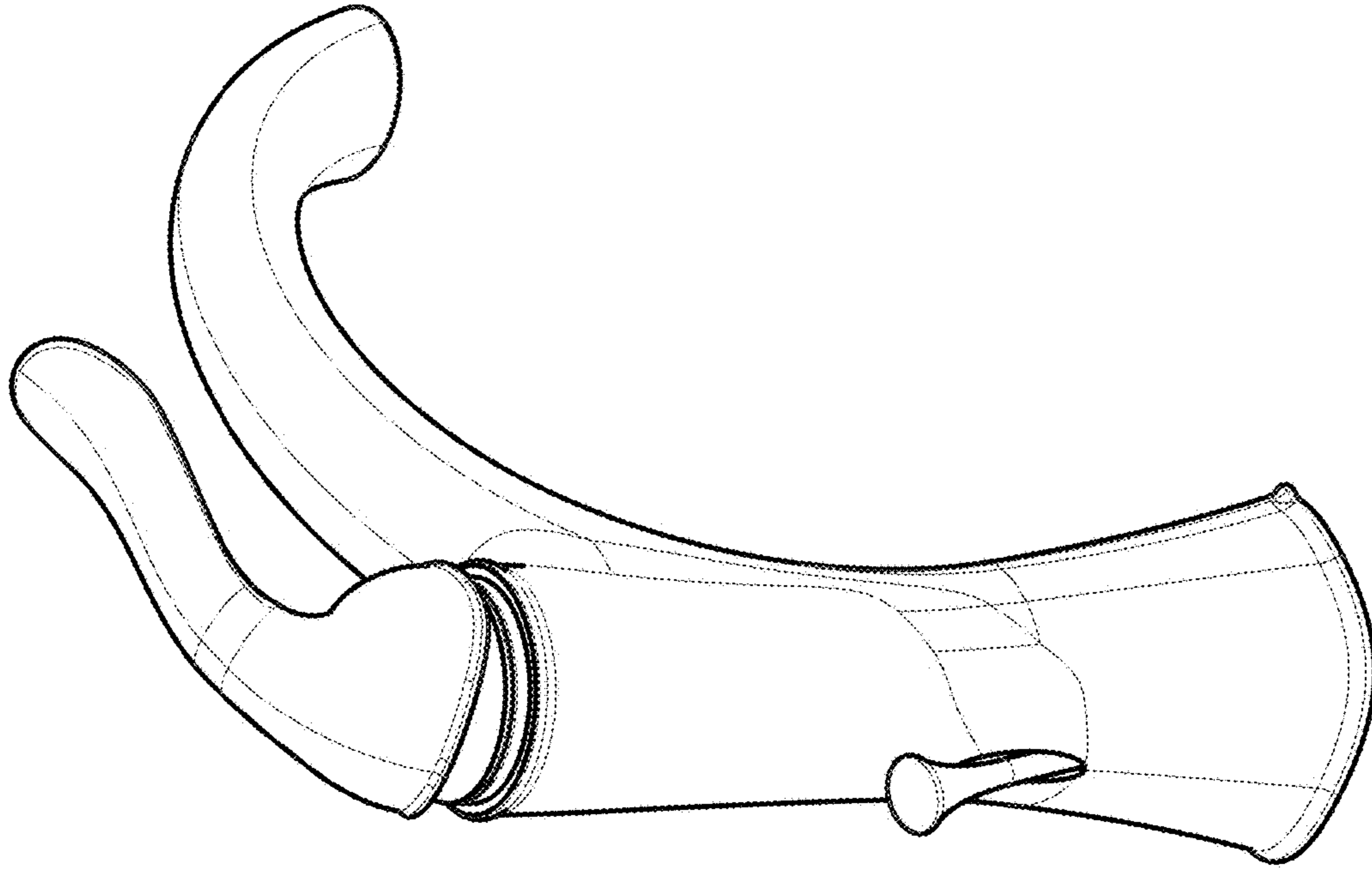

Fig. 2

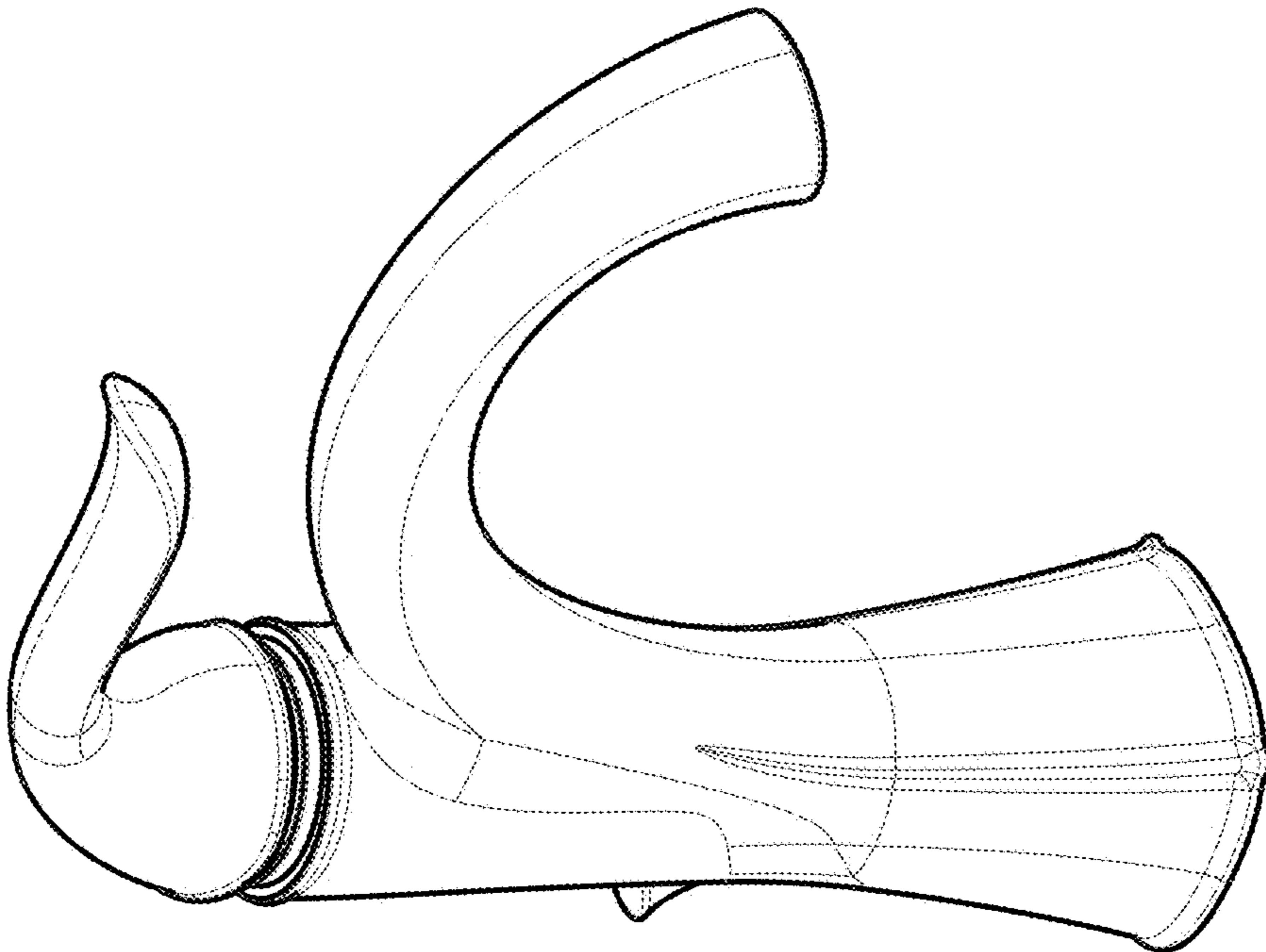

Fig. 1

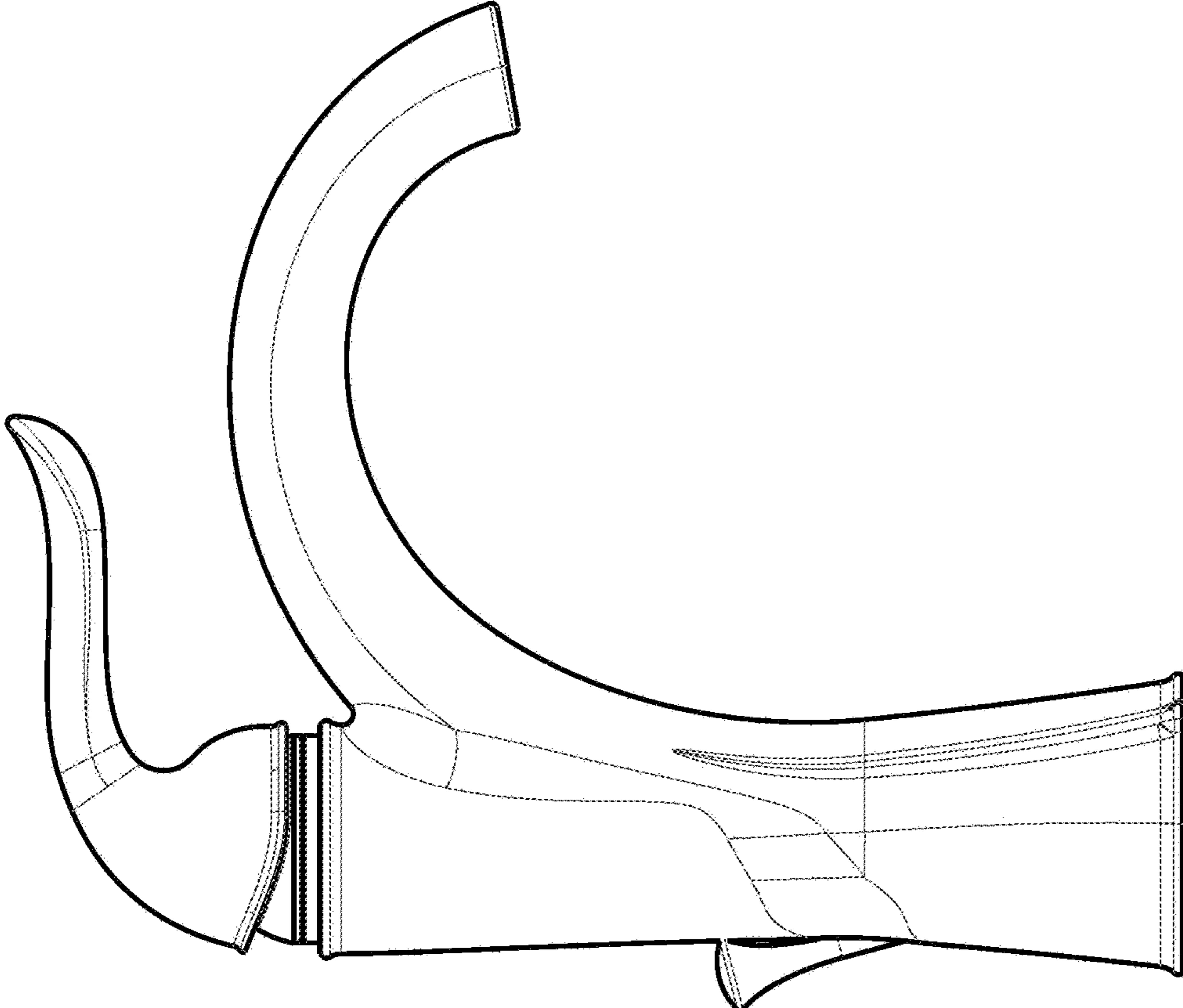

Fig. 3

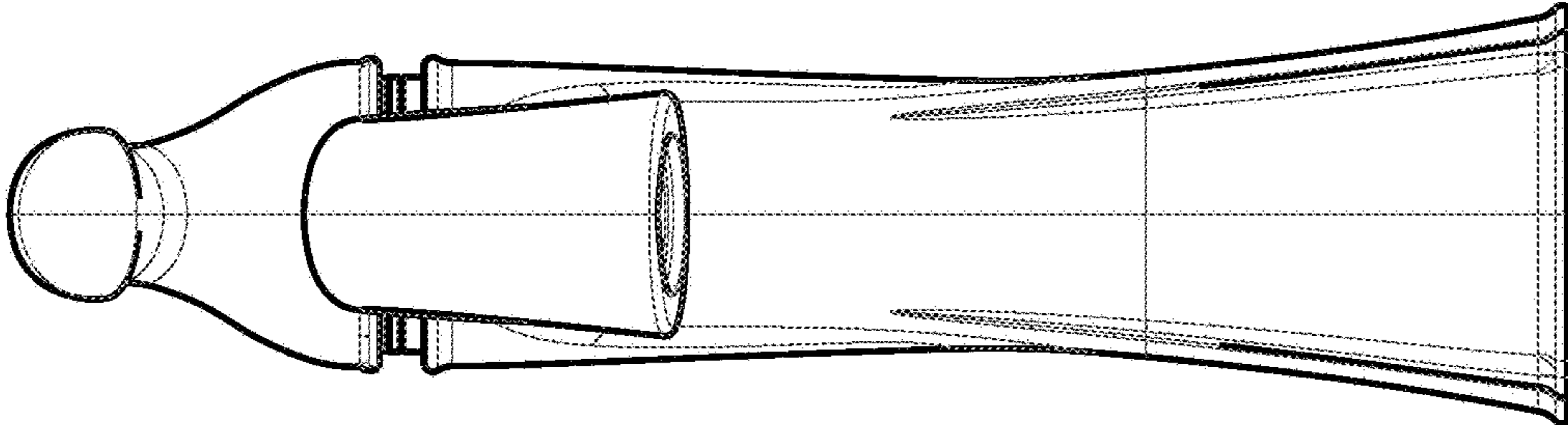

Fig. 4

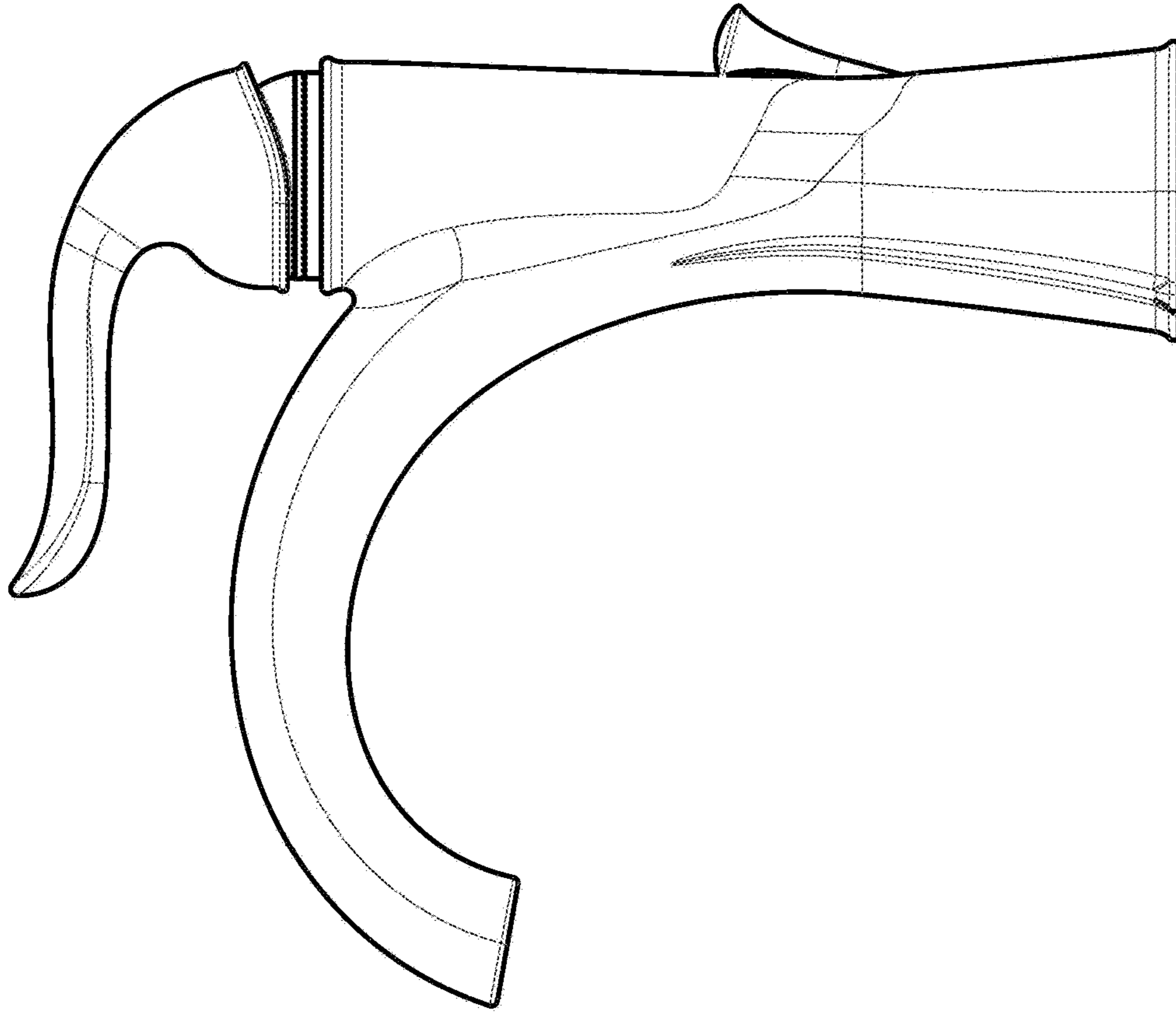

Fig. 5

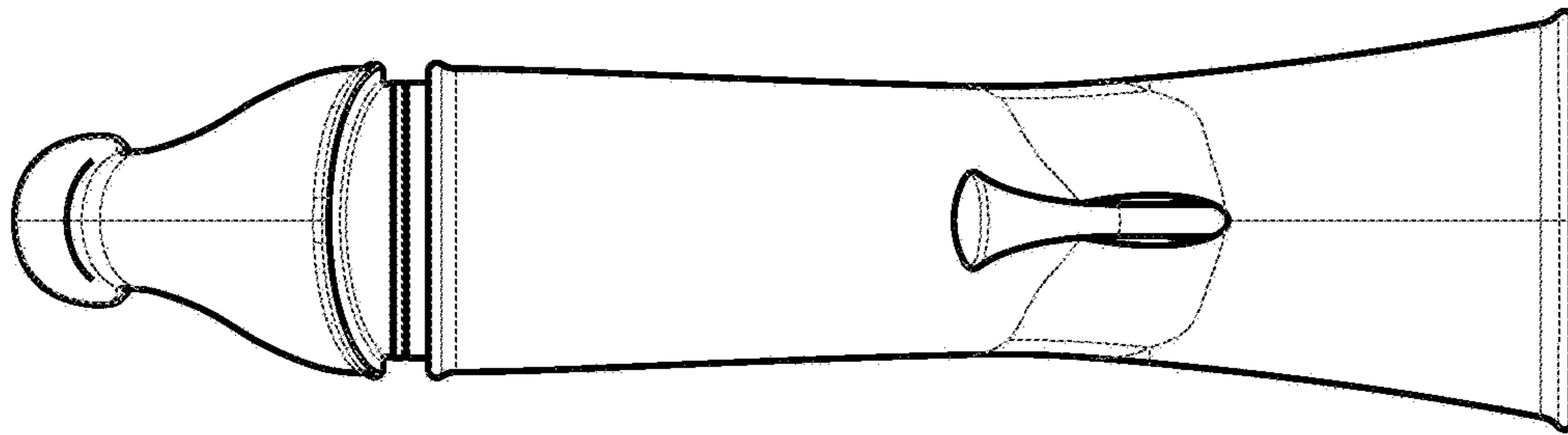

Fig. 6

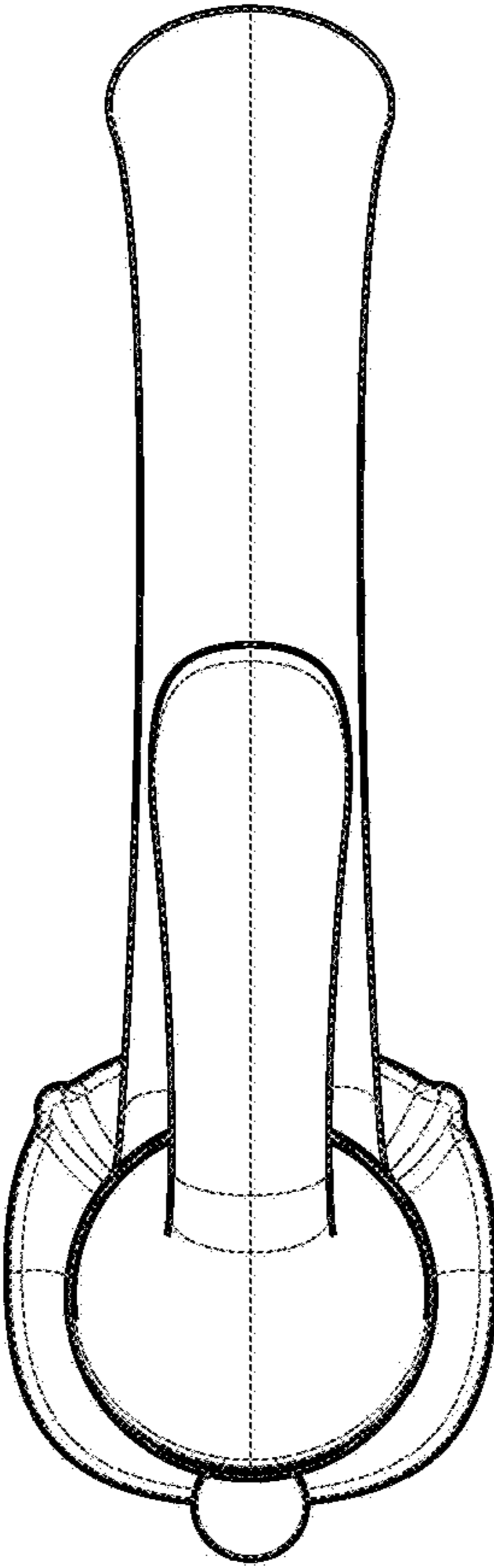

Fig. 7