



US00D896223S

(12) **United States Design Patent**
Amijo et al.

(10) **Patent No.:** **US D896,223 S**

(45) **Date of Patent:** **** Sep. 15, 2020**

(54) **DISPLAY DEVICE**

(71) Applicant: **HTC Corporation**, Taoyuan (TW)

(72) Inventors: **Natalia Amijo**, Taoyuan (TW);
Motokimi Yono, Taoyuan (TW); **Stuart Kyle**, Taoyuan (TW); **Benjamin Kai Norman Robertson**, Taoyuan (TW)

(73) Assignee: **HTC CORPORATION**, Taoyuan (TW)

(**) Term: **15 Years**

(21) Appl. No.: **29/674,931**

(22) Filed: **Dec. 27, 2018**

(51) **LOC (12) Cl.** **14-02**

(52) **U.S. Cl.**
USPC **D14/372**

(58) **Field of Classification Search**
USPC D14/372, 496, 432, 371, 125, 126, 129,
D14/299; D16/300-342; 351/158, 153,
351/144; 345/7-9, 905; 455/344;
348/115, 53, 121, 739
CPC G02B 27/017; G02B 27/0158; G02B
27/0161; G02B 27/0181; G02B 27/0185;
G02B 27/0189

See application file for complete search history.

(56) **References Cited**

U.S. PATENT DOCUMENTS

D801,970 S	11/2017	Sullivan et al.	
D838,718 S *	1/2019	Chiang	D14/372
D839,269 S *	1/2019	Wang	D14/372
D840,399 S *	2/2019	Miller	D14/372
D858,521 S *	9/2019	Neil	D14/372
D860,199 S *	9/2019	McGinty, Jr.	D14/372
D861,680 S *	10/2019	Chou	D14/372
D865,763 S *	11/2019	Lau	D14/372
D865,764 S *	11/2019	Miller	D14/372
D869,464 S *	12/2019	Chang	D14/372

D872,079 S *	1/2020	Huang	D14/372
D872,082 S *	1/2020	Denhez	D14/372
D873,825 S *	1/2020	Lionel	D14/372
D875,093 S *	2/2020	Park	D14/372

FOREIGN PATENT DOCUMENTS

CN	304301738 S	9/2017
JP	D1617521 S	11/2018
TW	D185058 S	8/2017

OTHER PUBLICATIONS

The Taiwanese Office Action and Search Report, dated Oct. 8, 2019, for Taiwanese Application No. 108302951 are provided.
The Taiwanese Office Action and Search Report, dated Oct. 8, 2019, for Taiwanese Application No. 108302952 are provided.
The Taiwanese Office Action and Search Report, dated Oct. 8, 2019, for Taiwanese Application No. 108302953 are provided.

(Continued)

Primary Examiner — Austin Murphy

(74) *Attorney, Agent, or Firm* — Birch, Stewart, Kolasch & Birch, LLP

(57) **CLAIM**

The ornamental design for a display device, as shown and described.

DESCRIPTION

FIG. 1 is a top perspective view of a display device in accordance with our new design;
FIG. 2 is a front view thereof;
FIG. 3 is a rear view thereof;
FIG. 4 is left view thereof;
FIG. 5 is a right view thereof;
FIG. 6 is a top plan view thereof; and,
FIG. 7 is a bottom plan view thereof.

1 Claim, 5 Drawing Sheets

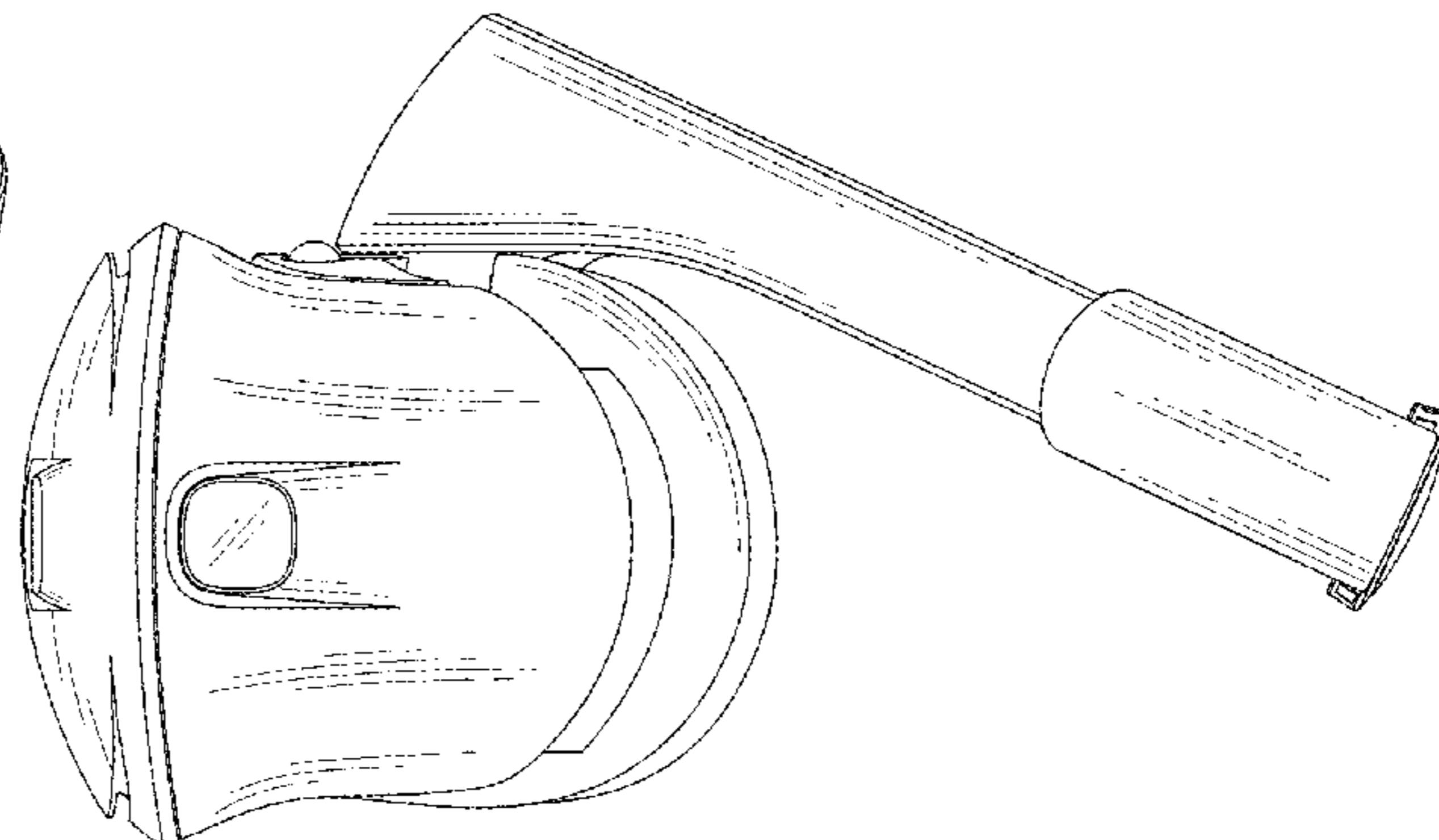
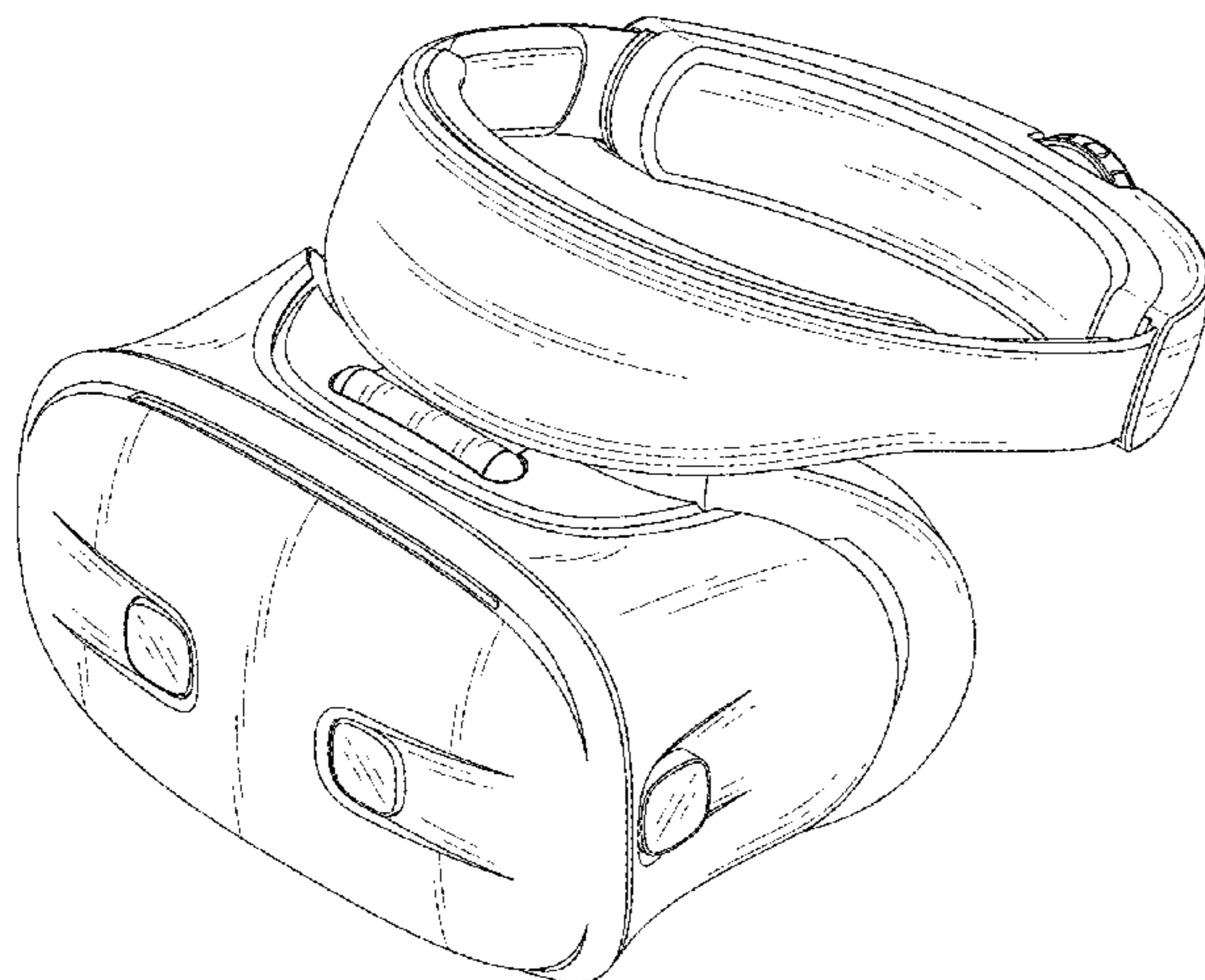

(56)

References Cited

OTHER PUBLICATIONS

The Taiwanese Office Action and Search Report, dated Oct. 8, 2019, for Taiwanese Application No. 108302954 are provided.

The Taiwanese Office Action and Search Report, dated Oct. 8, 2019, for Taiwanese Application No. 108302955 are provided.

The Taiwanese Office Action and Search Report, dated Oct. 8, 2019, for Taiwanese Application No. 108302956 are provided.

The Taiwanese Office Action and Search Report, dated Oct. 8, 2019, for Taiwanese Application No. 108302957 are provided.

* cited by examiner

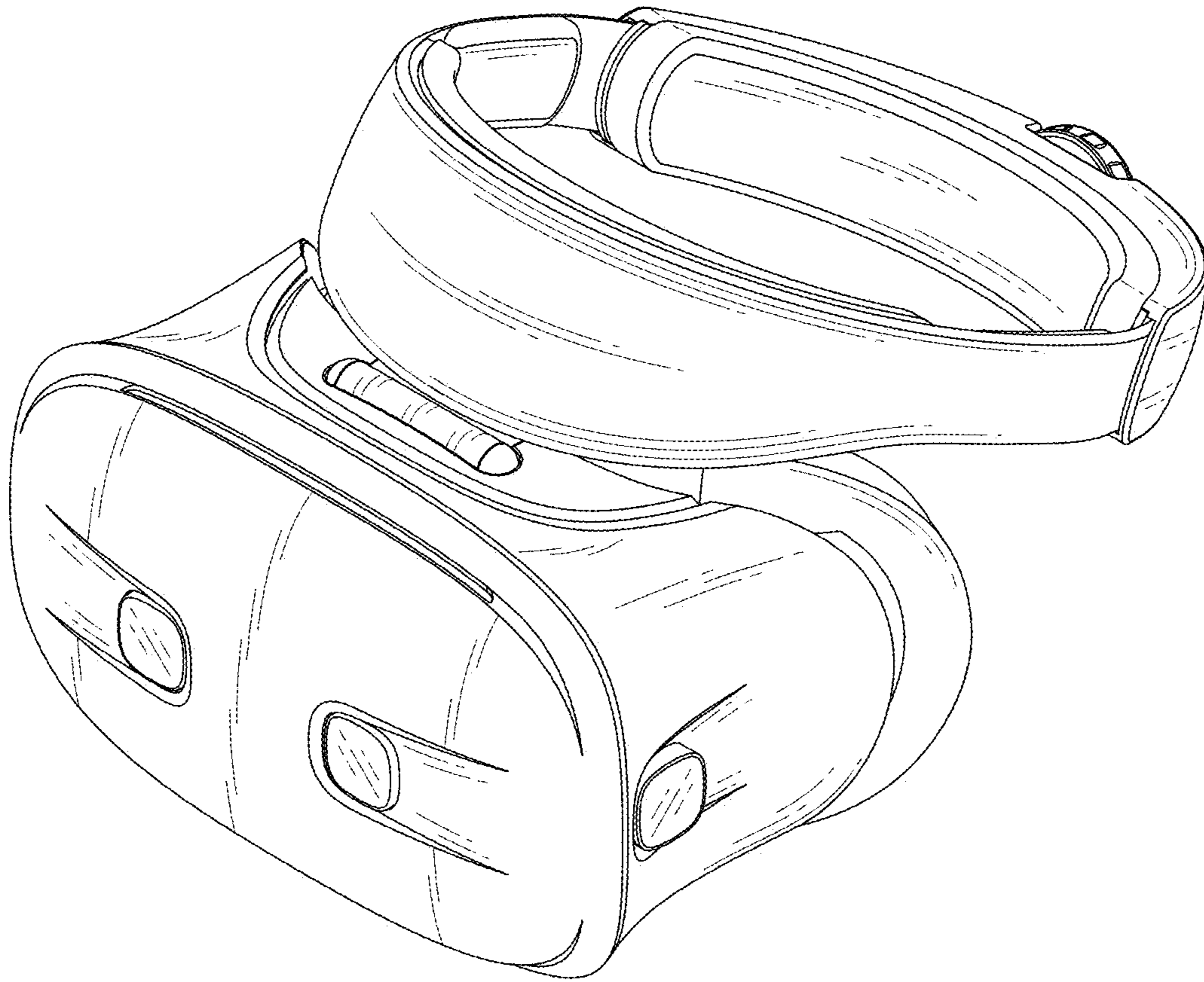

FIG. 1

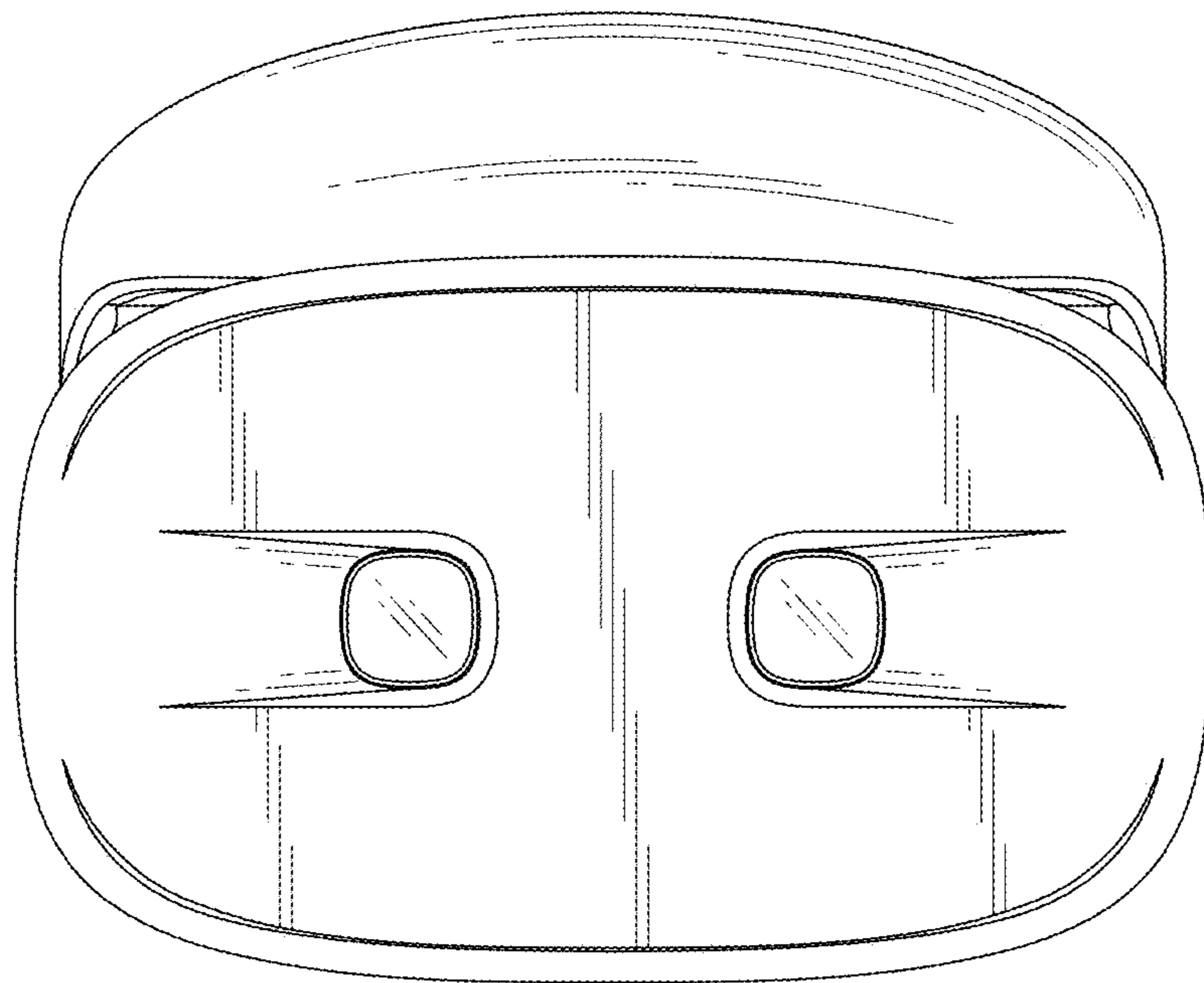

FIG. 2

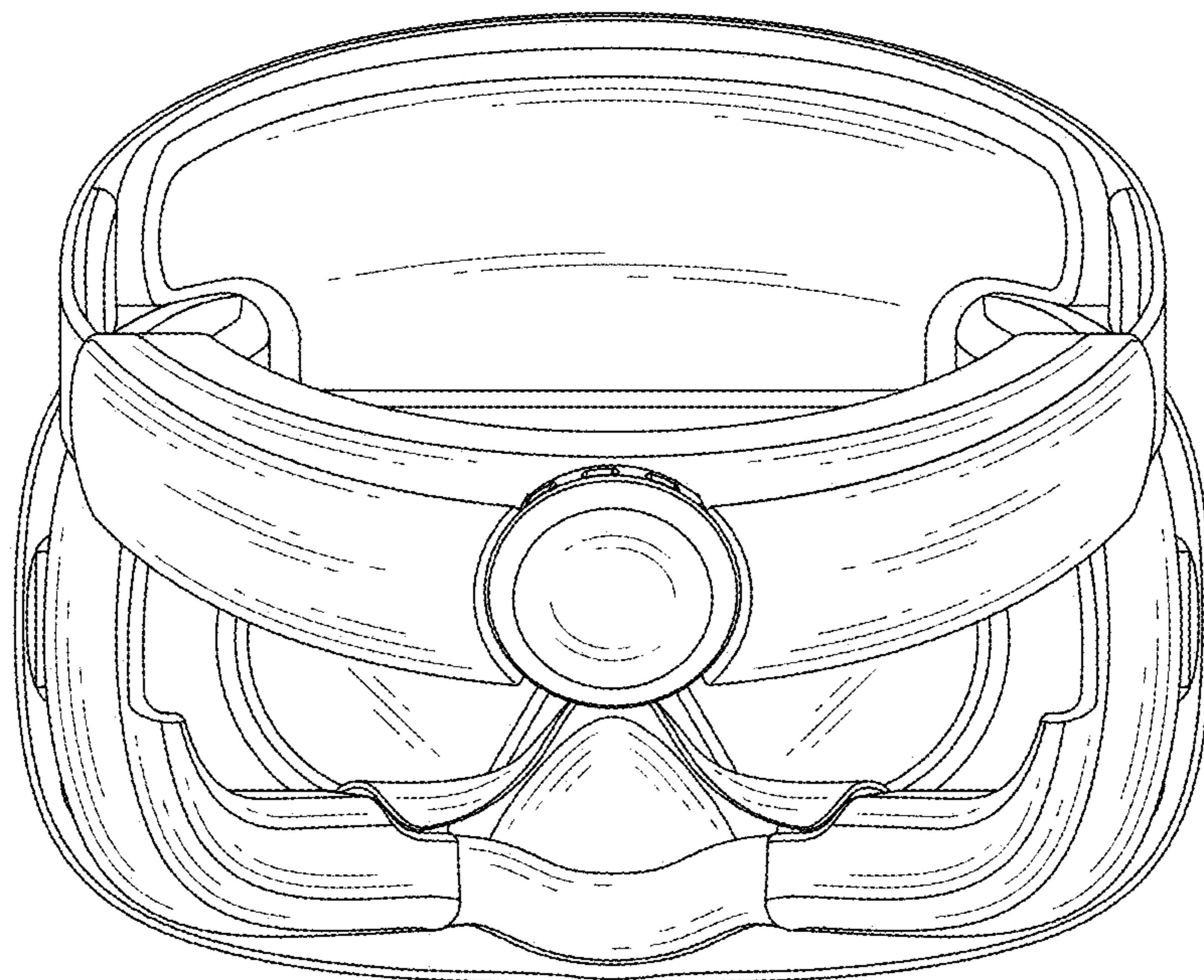

FIG. 3

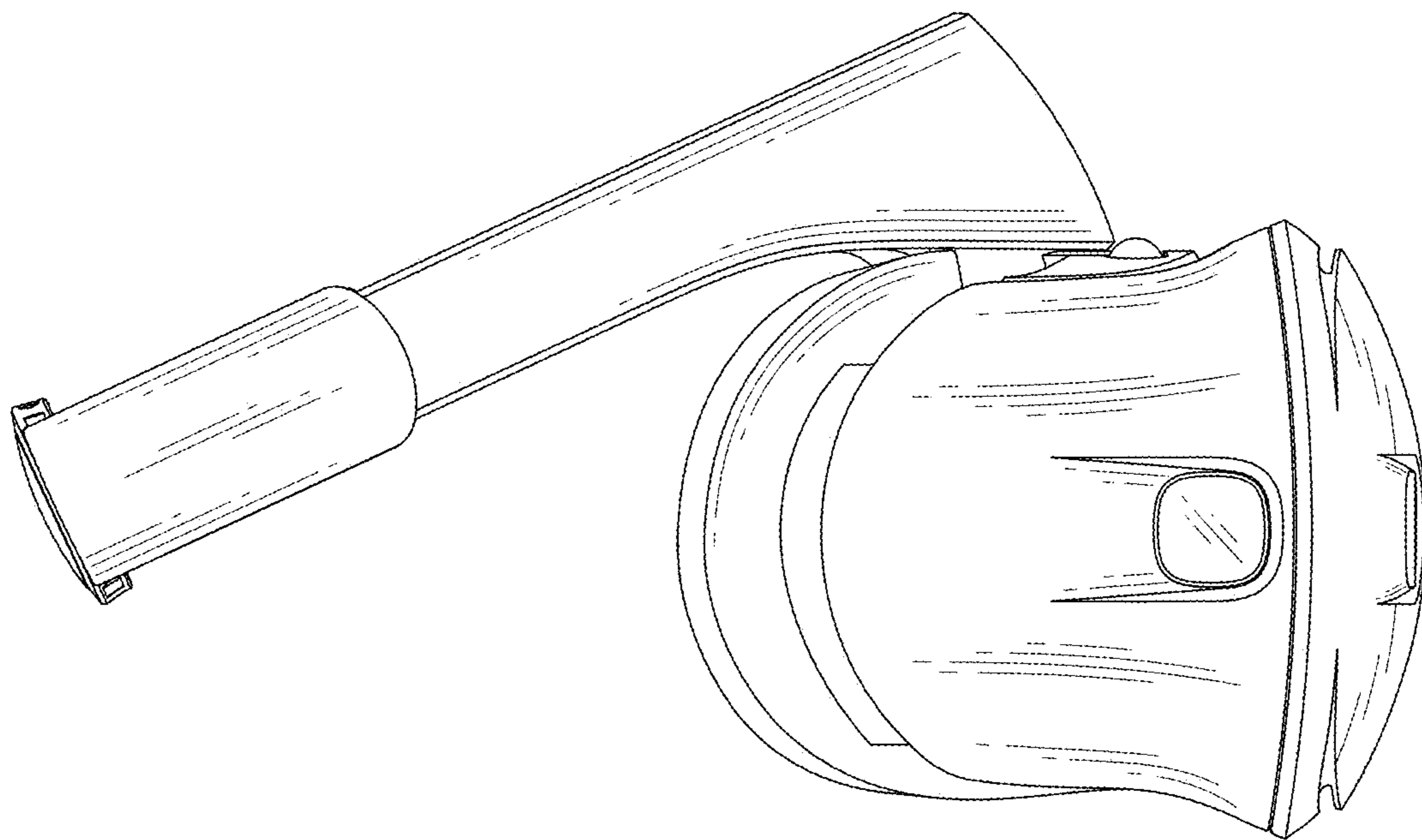

FIG. 4

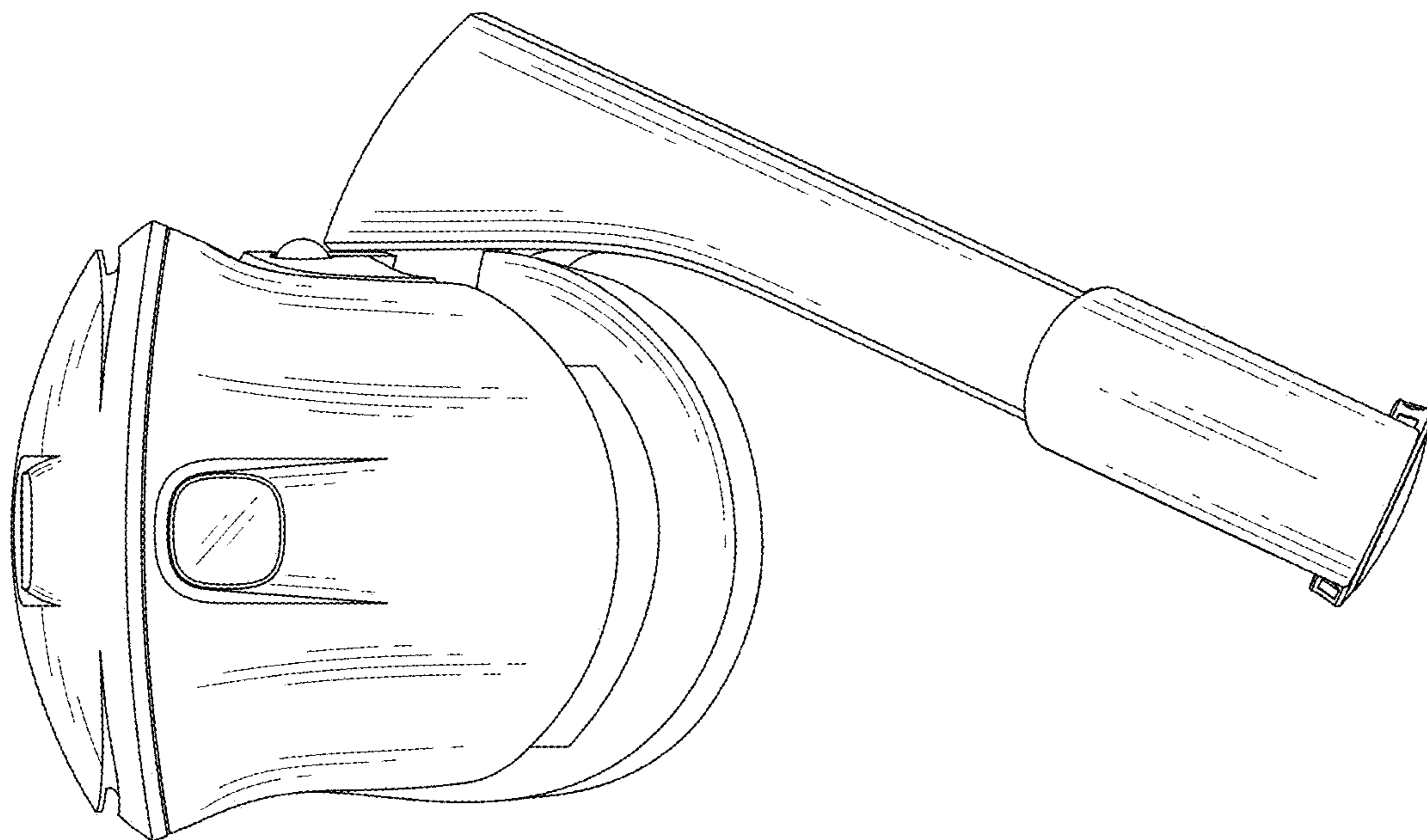

FIG. 5

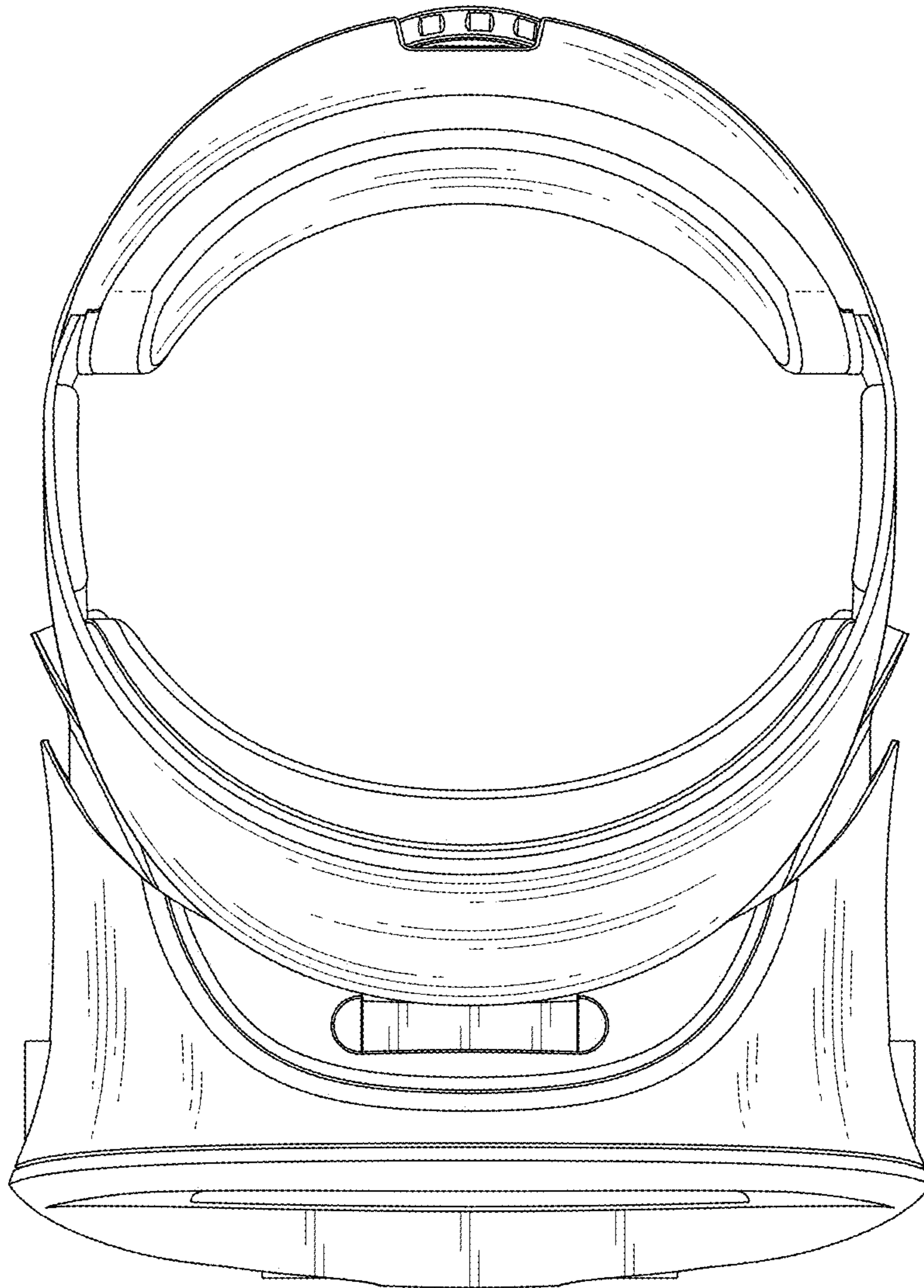

FIG. 6

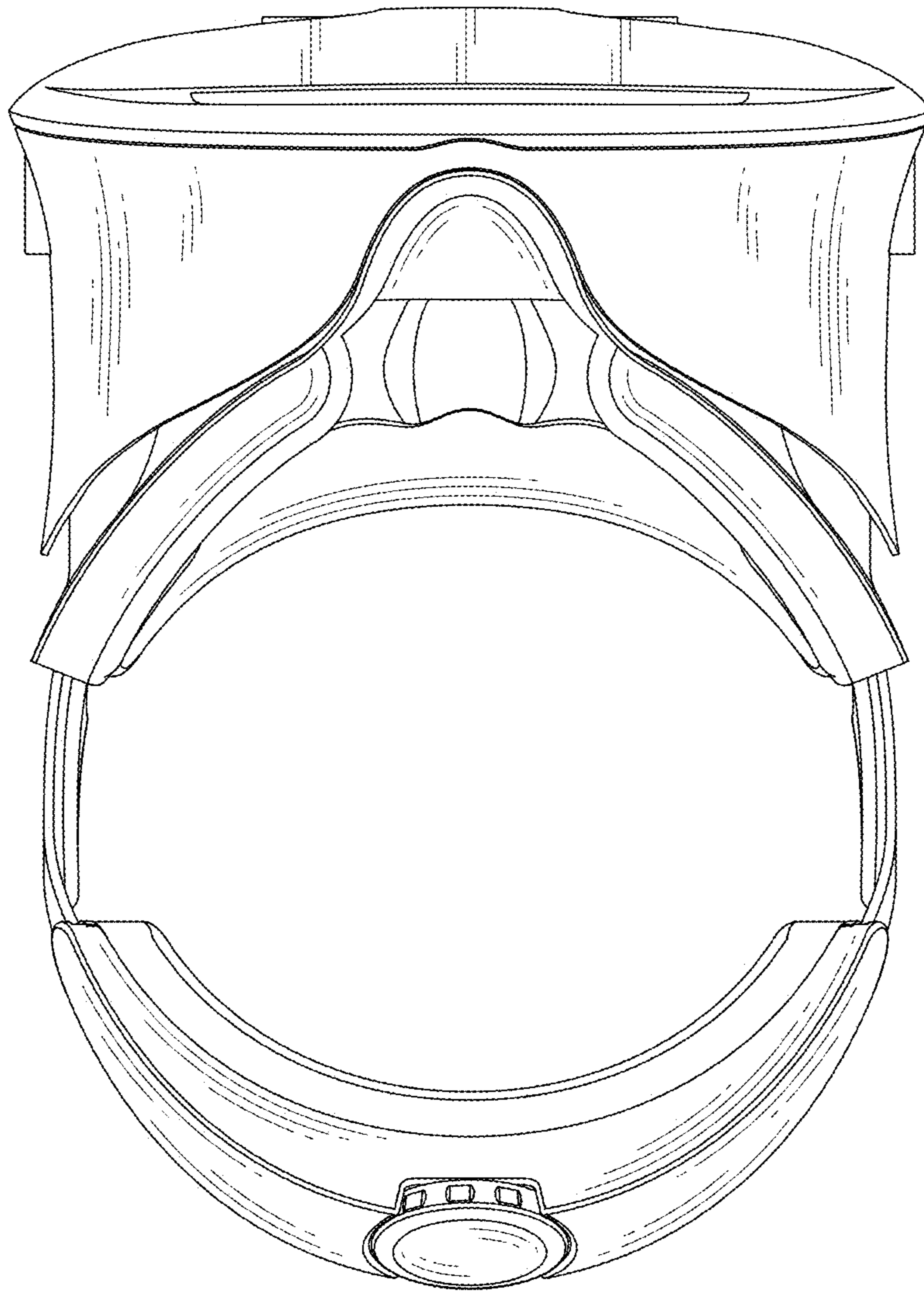

FIG. 7