

US00D896198S

(12) **United States Design Patent** (10) **Patent No.:** **US D896,198 S**
Nalbandian et al. (45) **Date of Patent:** **** Sep. 15, 2020**

(54) **MOBILE DEVICE**

(71) Applicant: **RAZER (ASIA-PACIFIC) PTE. LTD.**,
Singapore (SG)

(72) Inventors: **Saro Nalbandian**, San Francisco, CA
(US); **Scott Croyle**, San Francisco, CA
(US)

(73) Assignee: **RAZER (ASIA-PACIFIC) PTE. LTD.**,
Singapore (SG)

(**) Term: **15 Years**

(21) Appl. No.: **29/684,710**

(22) Filed: **Mar. 22, 2019**

Related U.S. Application Data

(62) Division of application No. 29/623,587, filed on Oct.
25, 2017, now Pat. No. Des. 851,054.

(51) **LOC (12) Cl.** **14-03**

(52) **U.S. Cl.**
USPC **D14/138 G**

(58) **Field of Classification Search**
USPC D14/138 G, 138 AD, 248, 341, 371, 374,
D14/138 R, 138 AA, 138 AB, 138 AC,
D14/138 C, 247

(Continued)

(56) **References Cited**

U.S. PATENT DOCUMENTS

D502,162 S 2/2005 Kim et al.
D541,785 S 5/2007 Hwang et al.

(Continued)

OTHER PUBLICATIONS

Razer Phone, announced Nov. 2017, [online], [retrieved on Apr. 25,
2020]. Retrieved from Internet ,<URL: <http://www.gsmarena.com>>.*

(Continued)

Primary Examiner — Bridget L Eland

(74) *Attorney, Agent, or Firm* — Polsinelli PC

(57) **CLAIM**

We claim the ornamental design for a mobile device, as
shown and described.

DESCRIPTION

FIG. 1 is a perspective view of a first embodiment of a
mobile device, showing our new design;
FIG. 2 is a front elevational view thereof;
FIG. 3 is a rear elevational view thereof;
FIG. 4 is a right side elevational view thereof;
FIG. 5 is a left side elevational view thereof;
FIG. 6 is a top plan view thereof; and
FIG. 7 is a bottom plan view thereof.

FIG. 8 is a perspective view of a second embodiment of a
mobile device, showing our new design;
FIG. 9 is a front elevational view thereof;
FIG. 10 is a rear elevational view thereof;
FIG. 11 is a right side elevational view thereof;
FIG. 12 is a left side elevational view thereof;
FIG. 13 is a top plan view thereof; and
FIG. 14 is a bottom plan view thereof.

FIG. 15 is a perspective view of a third embodiment of a
mobile device, showing our new design;
FIG. 16 is a front elevational view thereof;
FIG. 17 is a rear elevational view thereof;
FIG. 18 is a right side elevational view thereof;
FIG. 19 is a left side elevational view thereof;
FIG. 20 is a top plan view thereof; and
FIG. 21 is a bottom plan view thereof.

FIG. 22 is a perspective view of a fourth embodiment of a
mobile device, showing our new design;
FIG. 23 is a front elevational view thereof;
FIG. 24 is a rear elevational view thereof;
FIG. 25 is a right side elevational view thereof;
FIG. 26 is a left side elevational view thereof;
FIG. 27 is a top plan view thereof; and
FIG. 28 is a bottom plan view thereof.

FIG. 29 is a perspective view of a fifth embodiment of a
mobile device, showing our new design; and

(Continued)

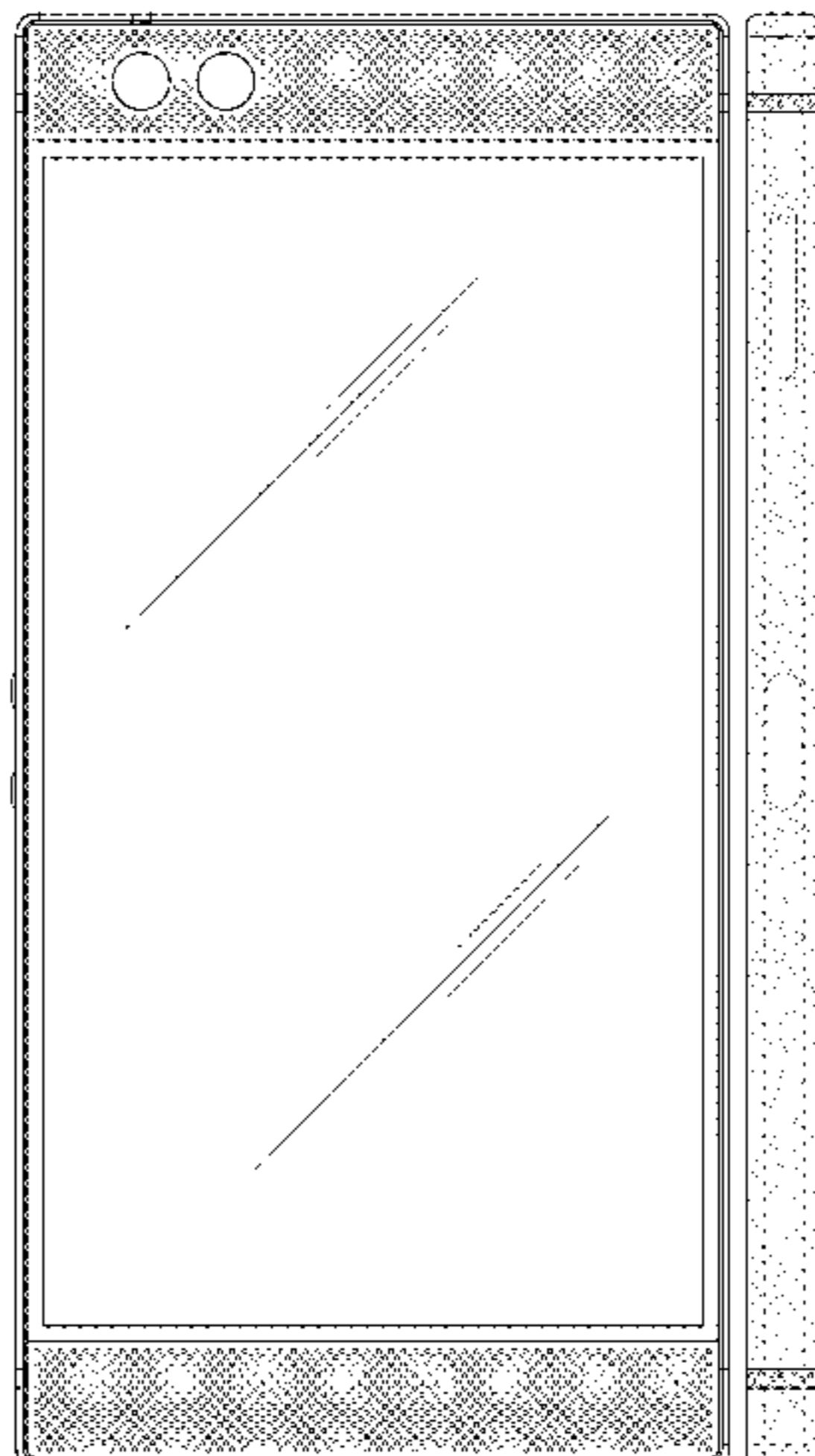

FIG. 30 is a front elevational view thereof;
 FIG. 31 is a rear elevational view thereof;
 FIG. 32 is a right side elevational view thereof;
 FIG. 33 is a left side elevational view thereof;
 FIG. 34 is a top plan view thereof; and
 FIG. 35 is a bottom plan view thereof.
 FIG. 36 is a perspective view of a sixth embodiment of a mobile device, showing our new design;
 FIG. 37 is a front elevational view thereof;
 FIG. 38 is a rear elevational view thereof;
 FIG. 39 is a right side elevational view thereof;
 FIG. 40 is a left side elevational view thereof;
 FIG. 41 is a top plan view thereof; and,
 FIG. 42 is a bottom plan view thereof.
 Broken lines are for illustrating portions of the mobile device which form no part of the claimed design.
 The contrast in stippling type between the light and dark stippling represents a contrast in appearance as shown.
 The logo present in the embodiments and forming part of the disclosure is a registered trademark of RAZER (ASIA-PACIFIC) PTE. LTD.

1 Claim, 42 Drawing Sheets

(58) **Field of Classification Search**

CPC H04M 1/0202; H04M 1/0235; H04M 1/0237; H04M 1/0239; H04M 1/0266; H04M 1/0268; H04M 1/027; H04M 1/0295; H04M 1/02; H04M 1/0279; H04M 1/0283

See application file for complete search history.

(56) **References Cited**

U.S. PATENT DOCUMENTS

D546,810 S	7/2007	Kwak
D578,987 S	10/2008	Lee et al.
D583,344 S	12/2008	Sohn et al.
D583,346 S	12/2008	Jung et al.
D592,168 S	5/2009	Bai et al.
D592,629 S	5/2009	Bai et al.
D609,680 S	2/2010	Kim et al.
D616,852 S	6/2010	Kim et al.
D622,718 S	8/2010	Andre et al.
D622,719 S	8/2010	Andre et al.
D654,464 S	2/2012	Han
D662,907 S	7/2012	Sim
D670,262 S	11/2012	Mitchell et al.
D673,924 S	1/2013	Mitchell et al.
D683,711 S	6/2013	Hofer et al.
D695,704 S	12/2013	Kim et al.
D712,368 S	9/2014	Hibi

D730,859 S	6/2015	Kaneta	
D736,766 S	8/2015	Paschke et al.	
D745,004 S	12/2015	Kim	
D745,483 S	12/2015	Dhondt	
D749,534 S	2/2016	Liu et al.	
D755,148 S	5/2016	Wu et al.	
D760,707 S	7/2016	Walliser et al.	
D762,607 S	8/2016	Yoon et al.	
D768,594 S	10/2016	Szeto	
D770,409 S	11/2016	Jing	
D770,433 S	11/2016	Kangasmaa et al.	
D774,486 S	12/2016	Defazio et al.	
D777,700 S	1/2017	Kwon et al.	
D780,179 S	2/2017	Bae et al.	
D783,564 S	4/2017	Park et al.	
D787,467 S	5/2017	Xu	
D788,729 S	6/2017	Park et al.	
D788,733 S	6/2017	Park et al.	
D789,902 S	6/2017	Park et al.	
D790,496 S	6/2017	Park et al.	
D790,534 S	* 6/2017	Paschke D14/341
D791,732 S	7/2017	Xu et al.	
D801,295 S	10/2017	Park et al.	
D801,947 S	11/2017	Gordon et al.	
D802,550 S	* 11/2017	Enquist D14/138 G
D808,952 S	1/2018	Defazio et al.	
D812,049 S	3/2018	Akana et al.	
D817,297 S	5/2018	Lee	
D820,801 S	6/2018	Yeom	
D822,633 S	7/2018	Yeom	
D823,272 S	7/2018	Croyle	
D827,605 S	* 9/2018	Yao D14/138 G
D827,625 S	9/2018	Berneth	
D829,187 S	9/2018	Zhang	
D838,270 S	1/2019	Cho et al.	
D840,367 S	* 2/2019	Jiang D14/138 G
D841,611 S	* 2/2019	Kim D14/138 G
D851,054 S	* 6/2019	Nalbandian D14/138 G
D861,630 S	* 10/2019	Chiang D14/138 G
2008/0045279 A1	2/2008	Ohki	

OTHER PUBLICATIONS

Razer Phone 2, announced Oct. 2018, [online], [retrieved on Apr. 25, 2020]. Retrieved from Internet ,<URL: <http://www.gsmarena.com>>.*
 Applie iPhone 7 Plus, announced Sep. 2016, [online], [retrieved on Jan. 26, 2019]. Retrieved from Internet, <URL: <http://www.gsmarena.com>>.
 Plum Might, announced May 2012, [online], [retrieved on Nov. 28, 2012]. Retrieved from Internet , <URL: [http:// www.gsmarena.com](http://www.gsmarena.com)>.
 HTC One, announced Feb. 2013, [online], [retrieved on Mar. 4, 2013]. Retrieved from Internet,<URL: <http://www.gsmarena.com>>.
 BlackBerry Z10, announced Jan. 2013, [online], [retrieved on Mar. 4, 2013]. Retrieved from Internet,<URL: [http:// www.gsmarena.com](http://www.gsmarena.com)>.

* cited by examiner

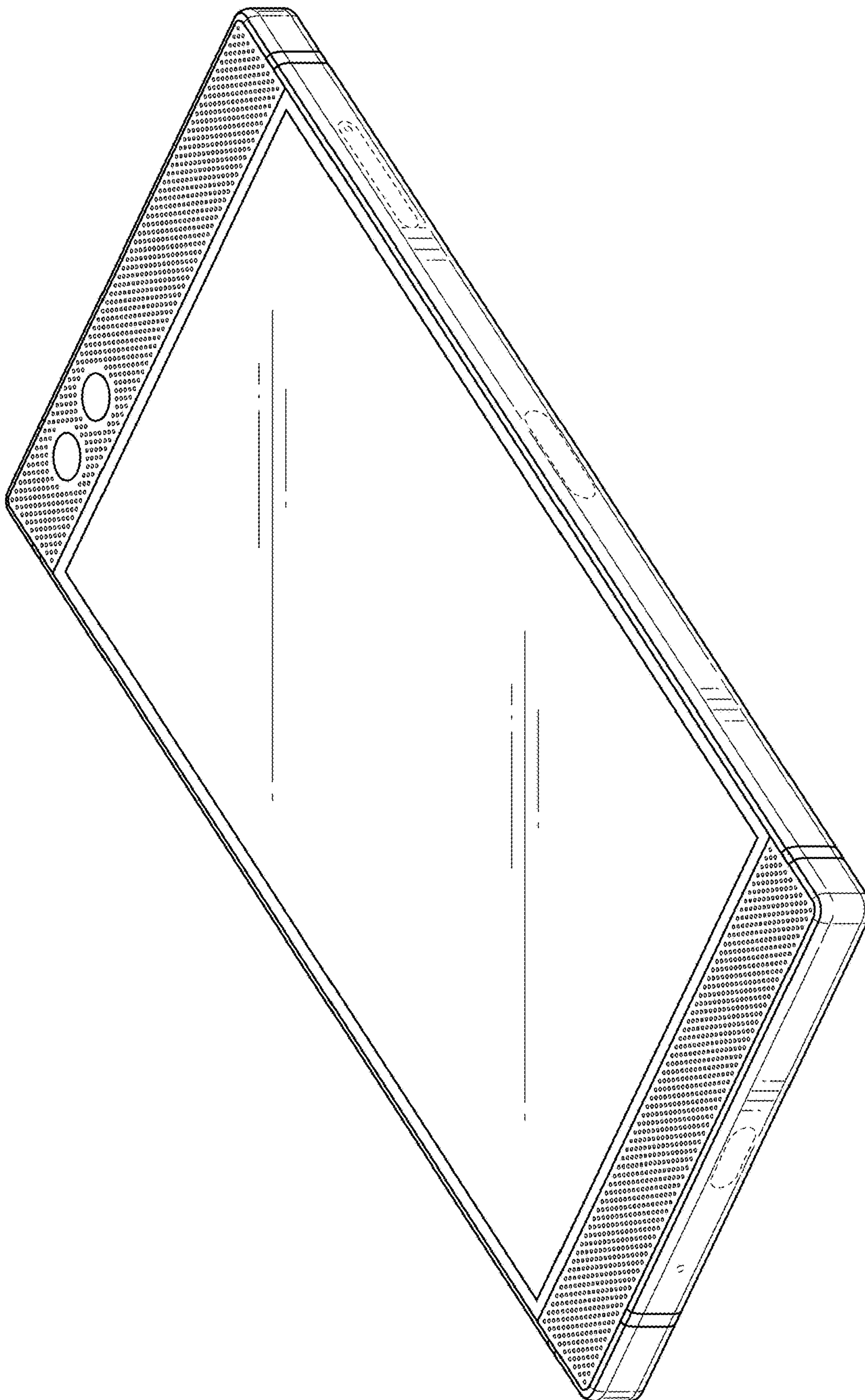

FIG. 1

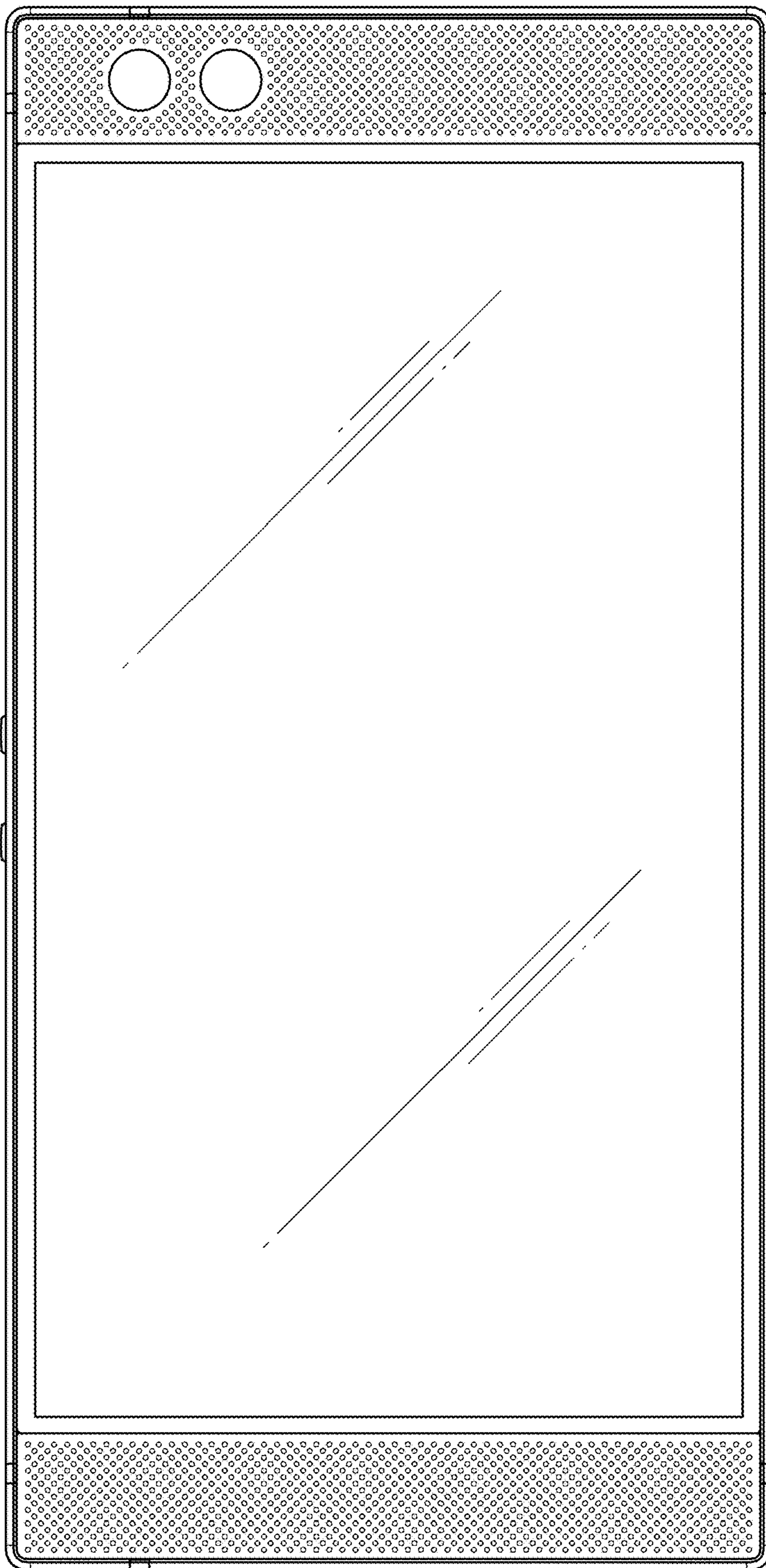

FIG. 2

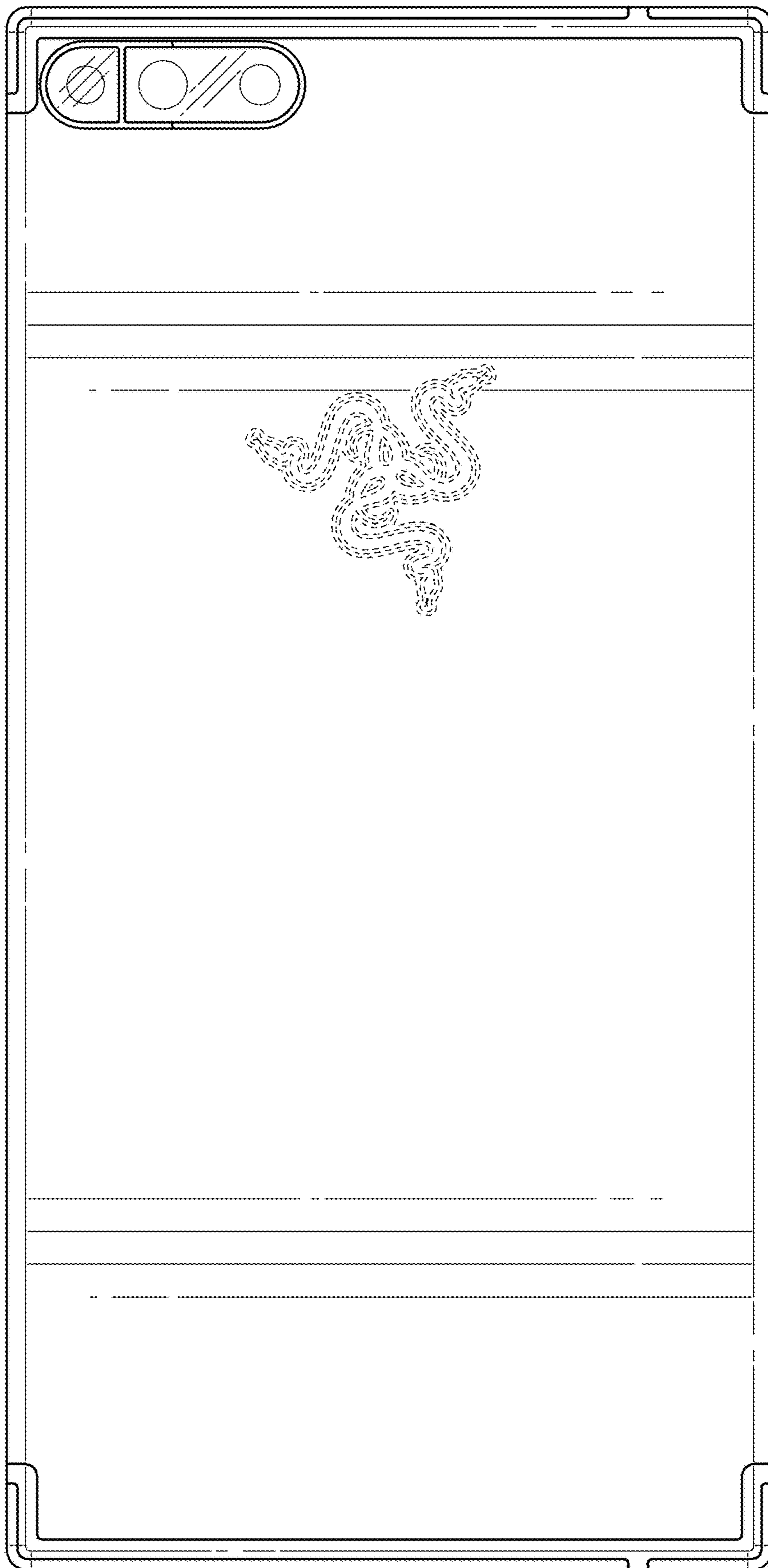

FIG. 3

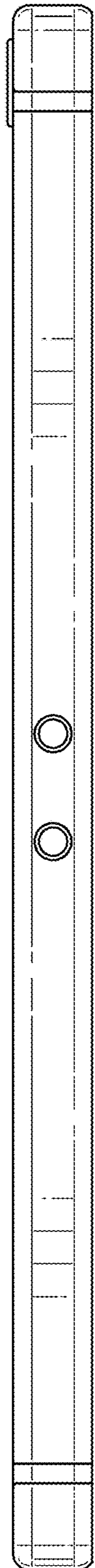

FIG. 4

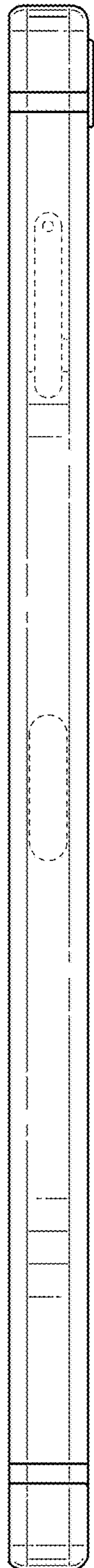

FIG. 5

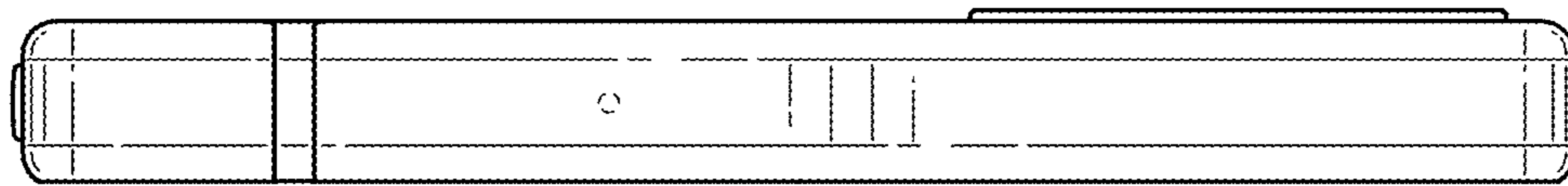

FIG. 6

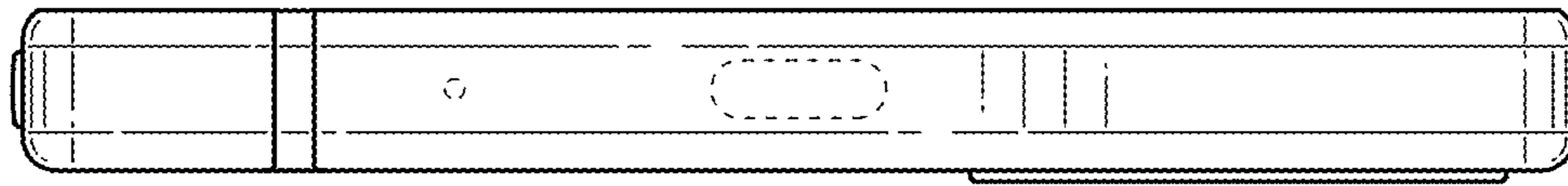

FIG. 7

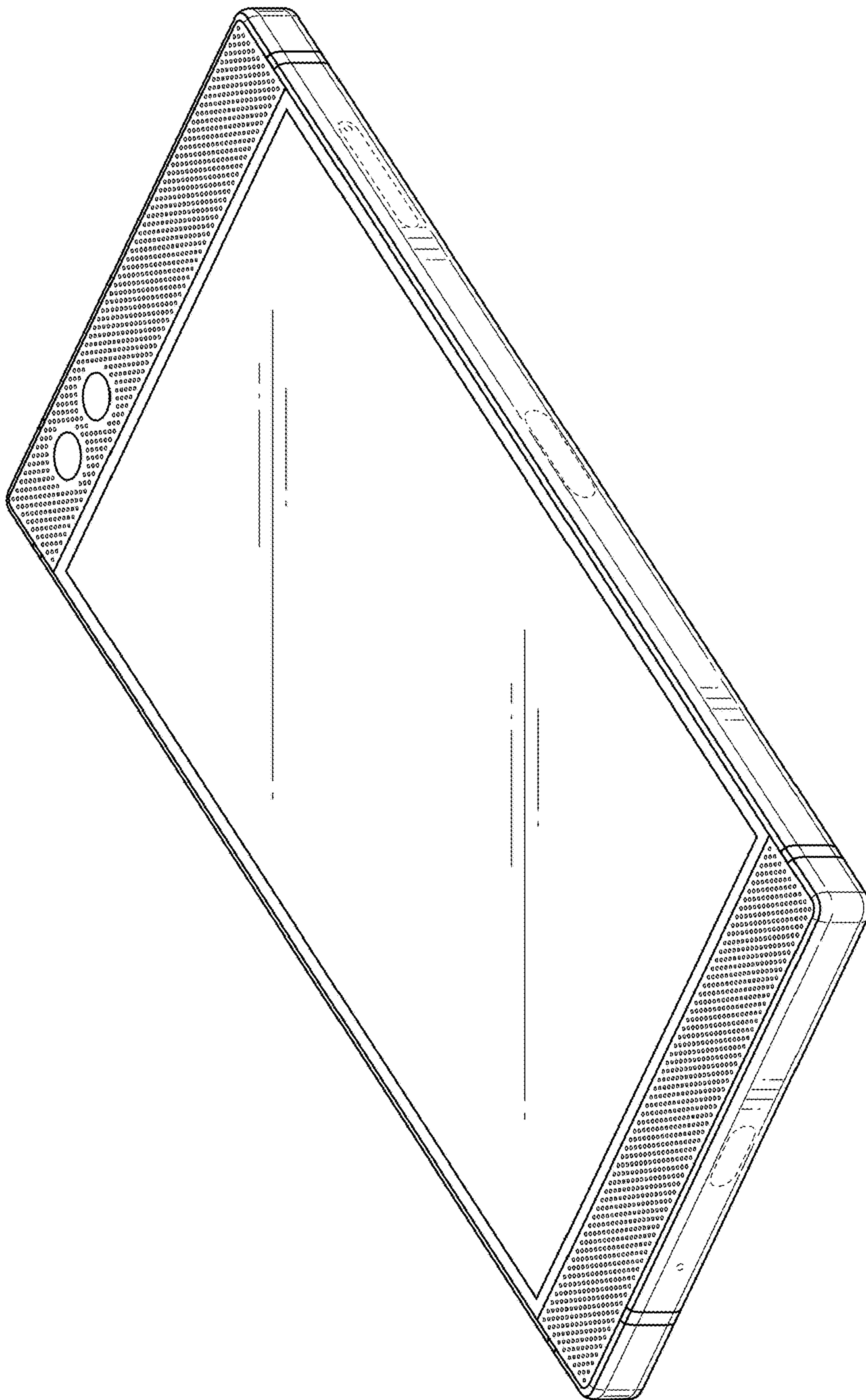

FIG. 8

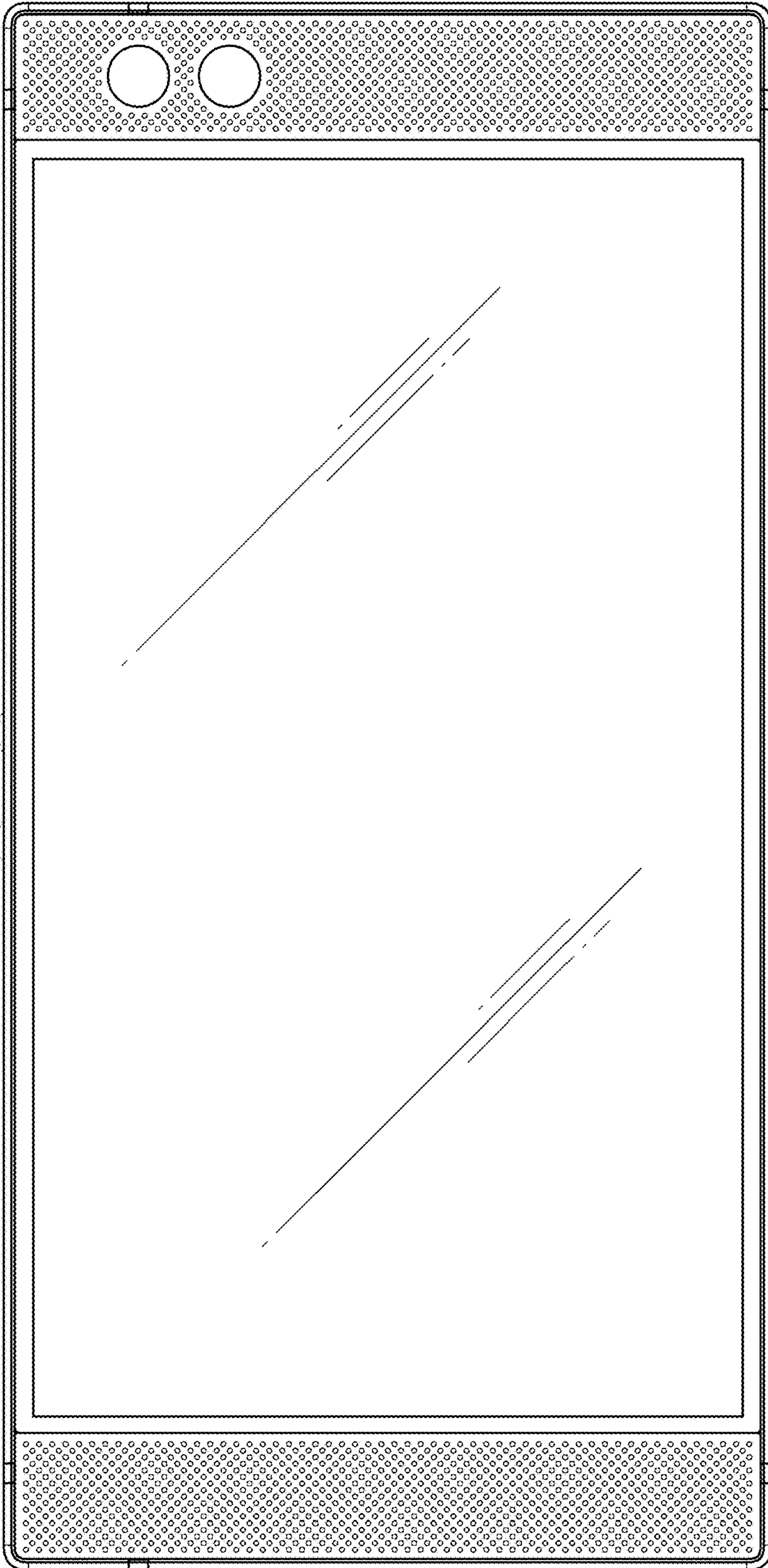

FIG. 9

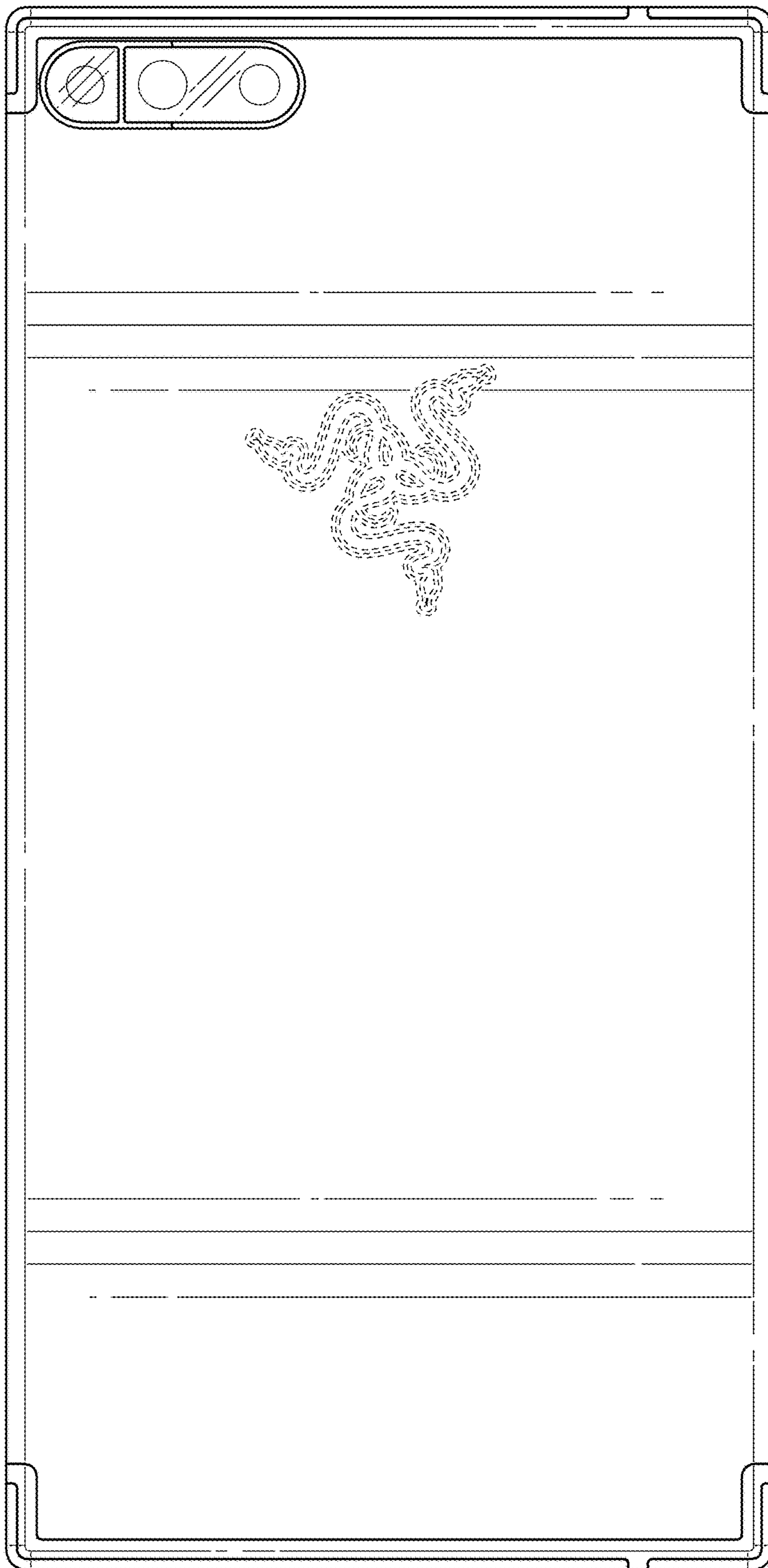

FIG. 10

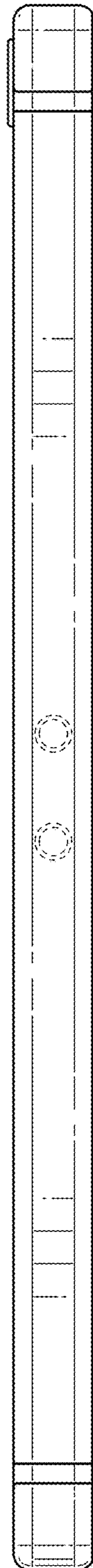

FIG. 11

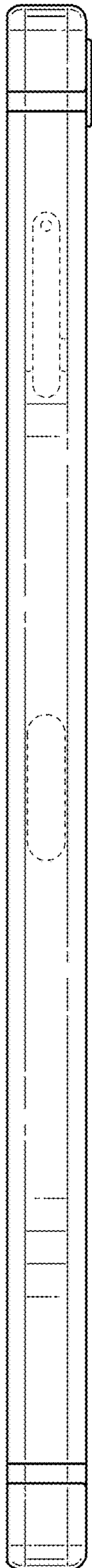

FIG. 12

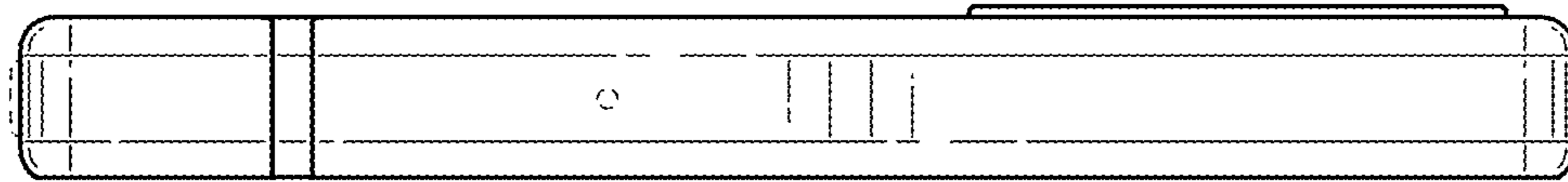

FIG. 13

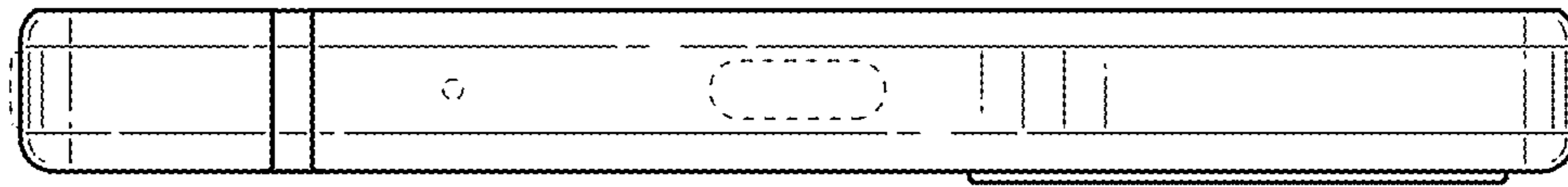

FIG. 14

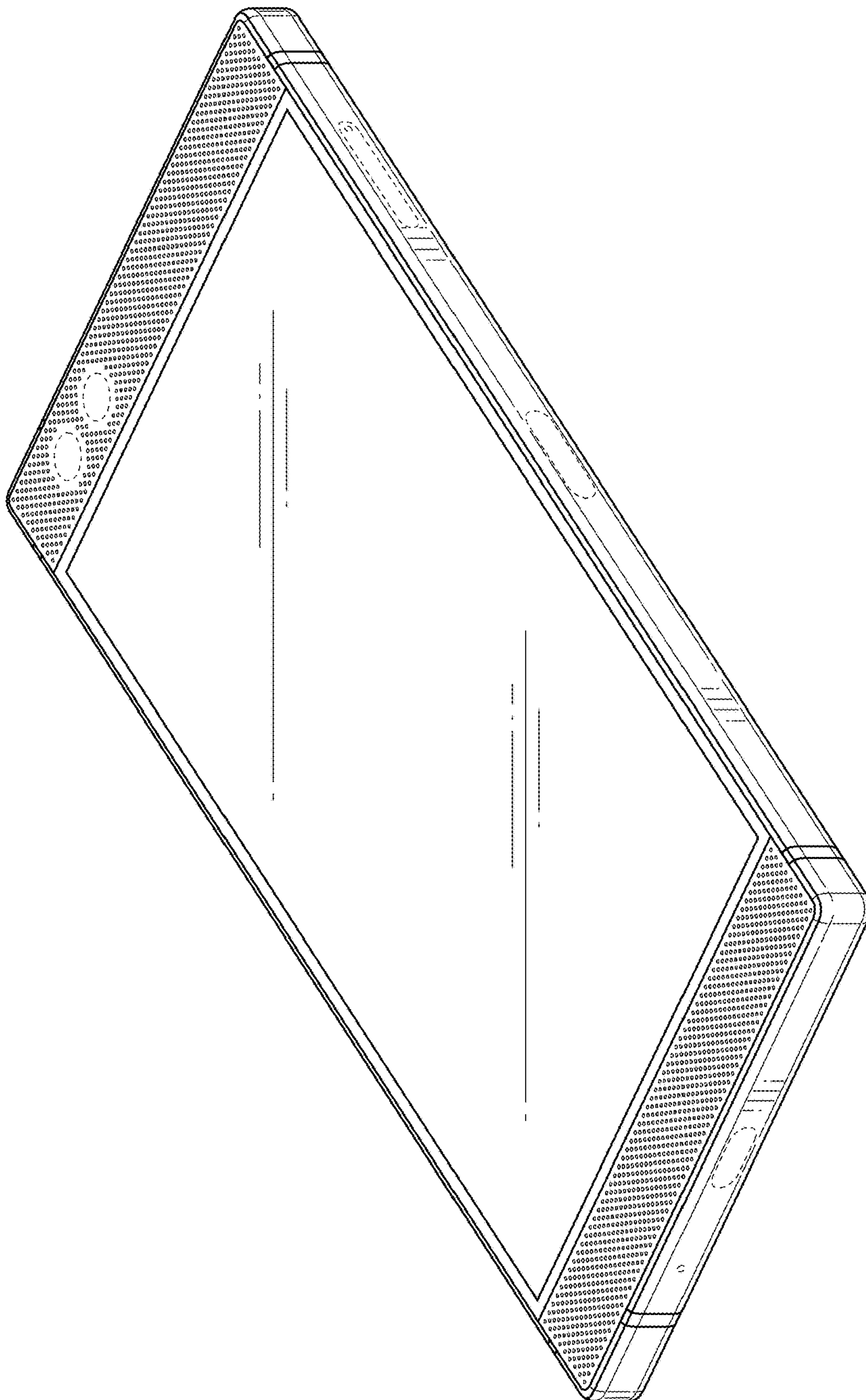

FIG. 15

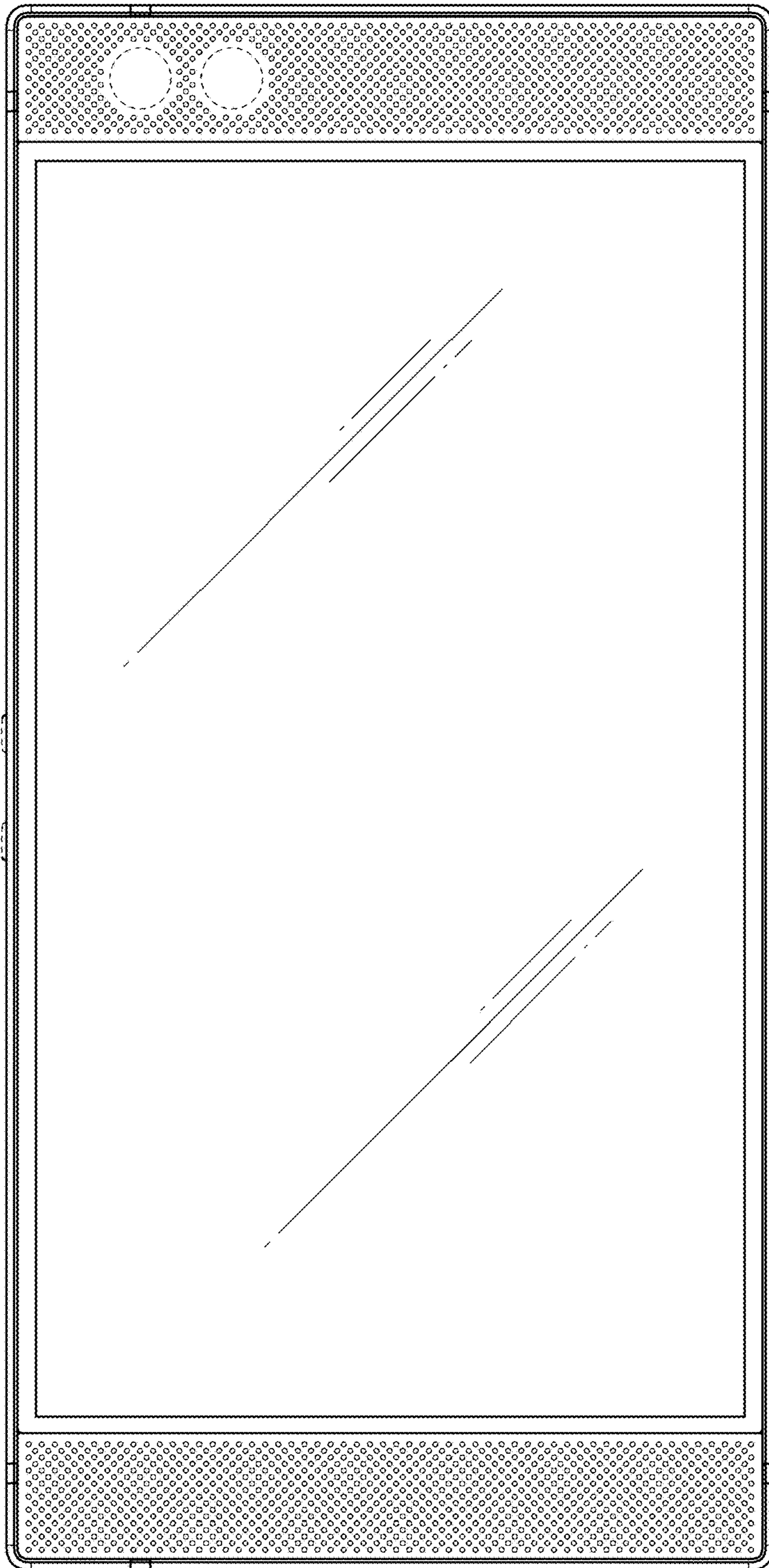

FIG. 16

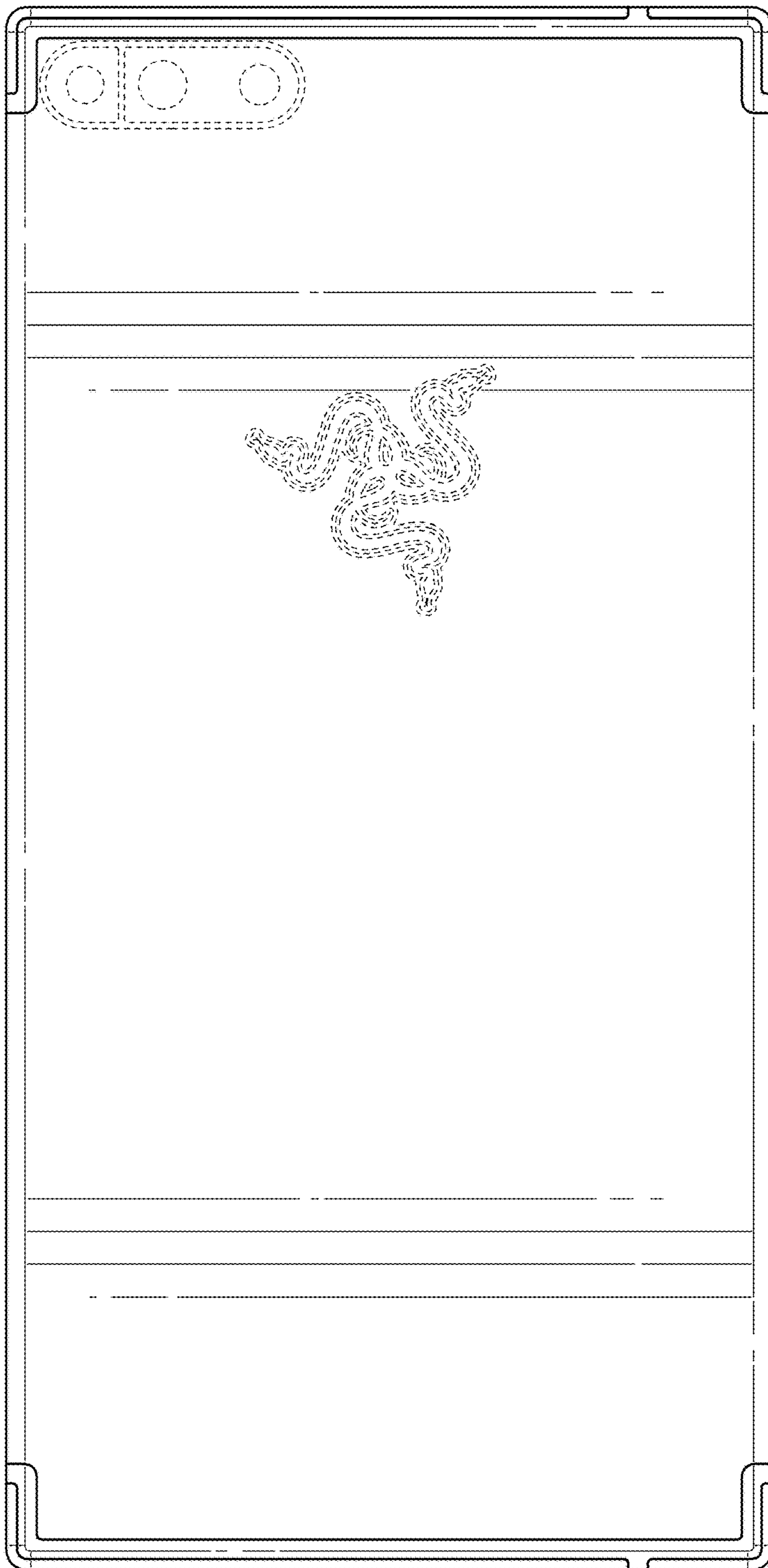

FIG. 17

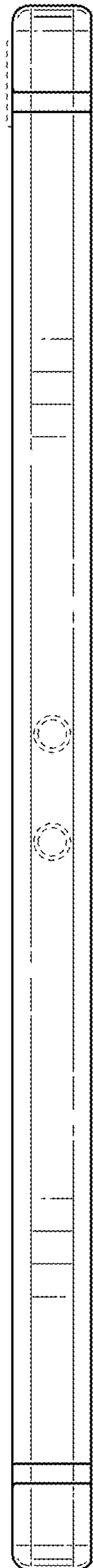

FIG. 18

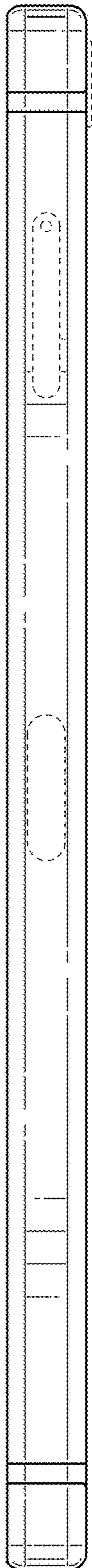

FIG. 19

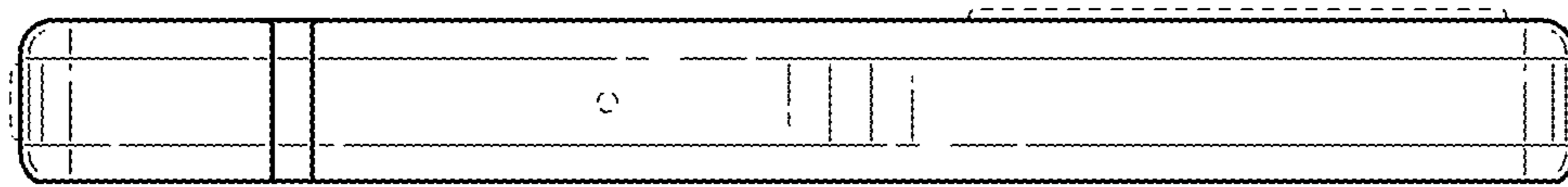

FIG. 20

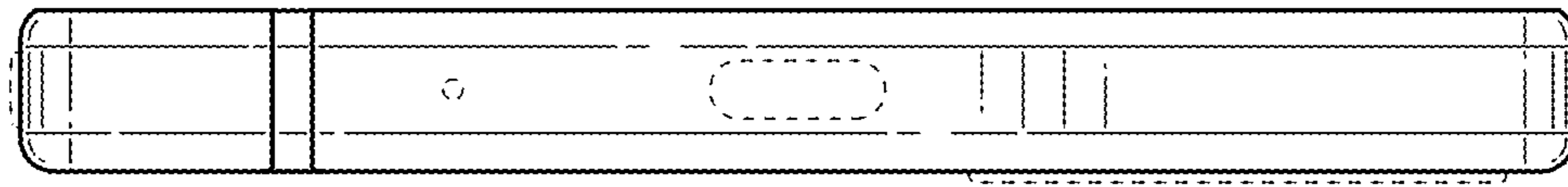

FIG. 21

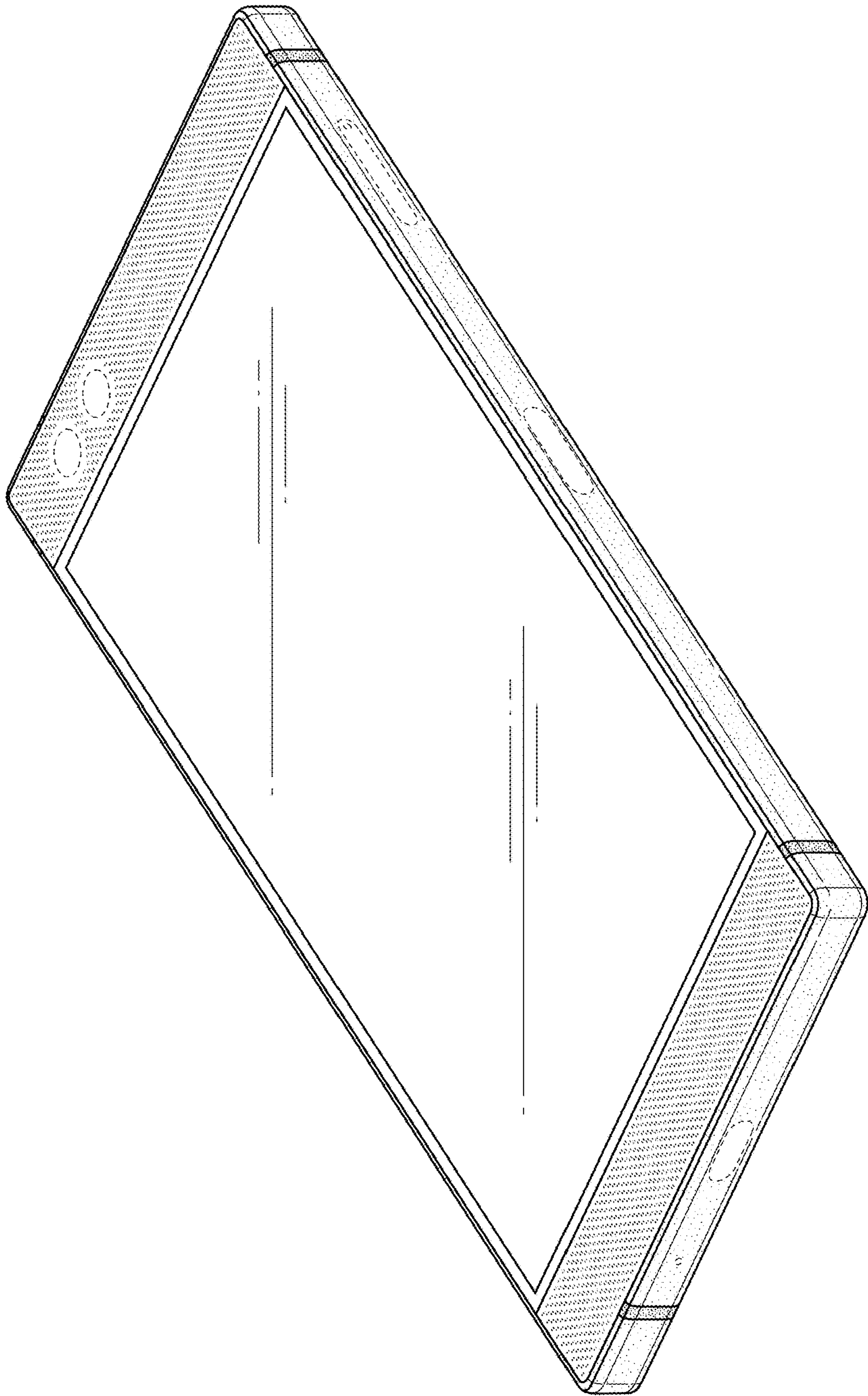

FIG. 22

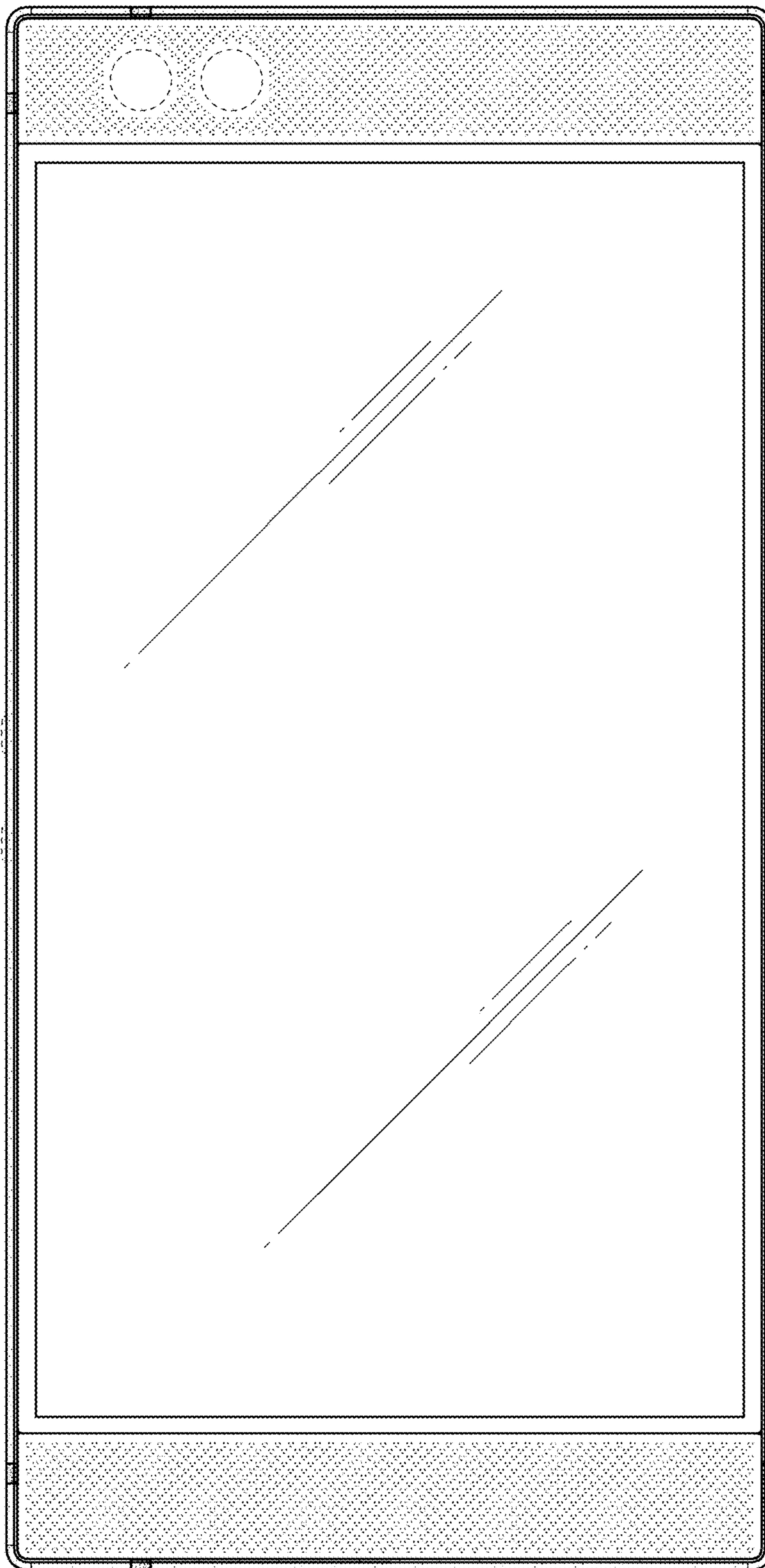

FIG. 23

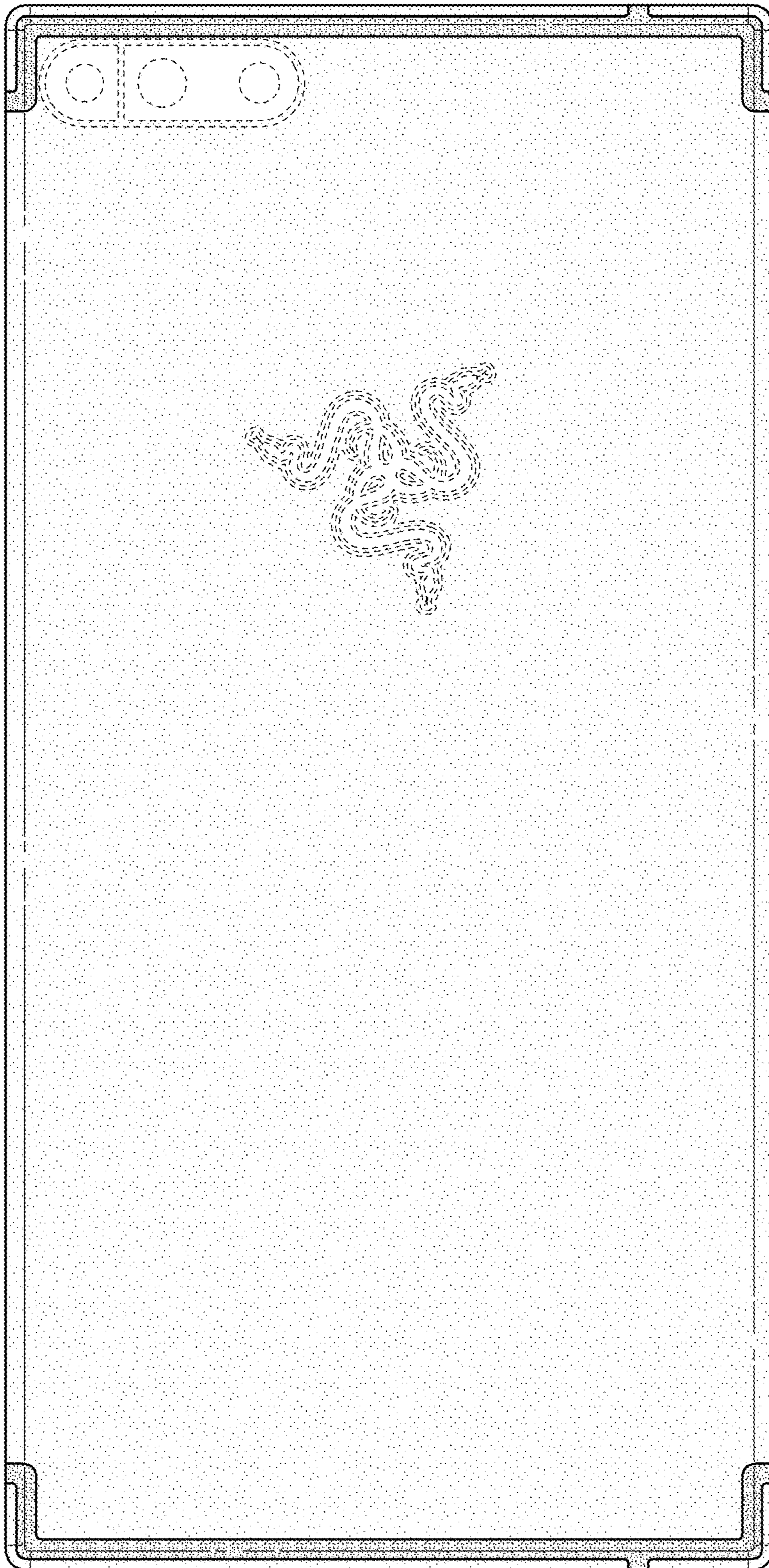

FIG. 24

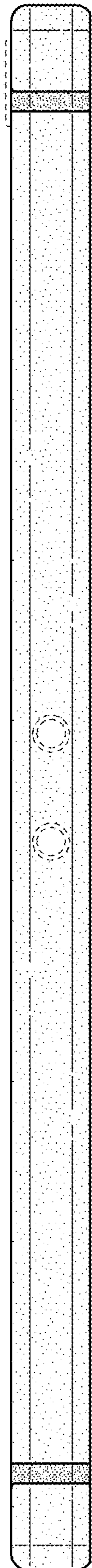

FIG. 25

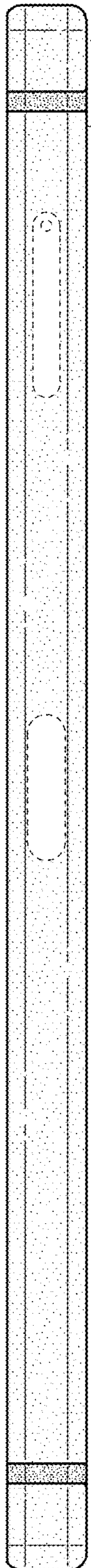

FIG. 26

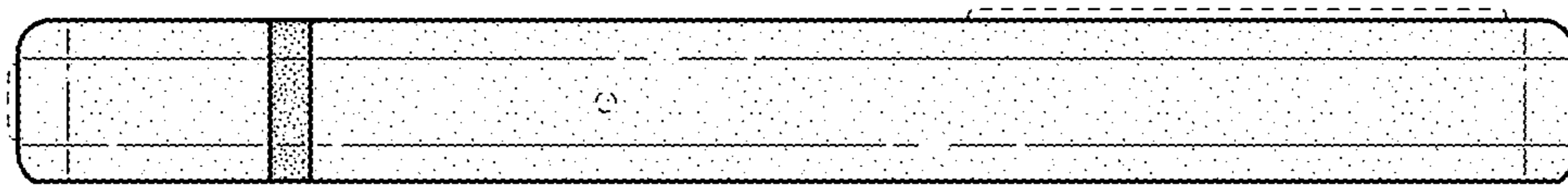

FIG. 27

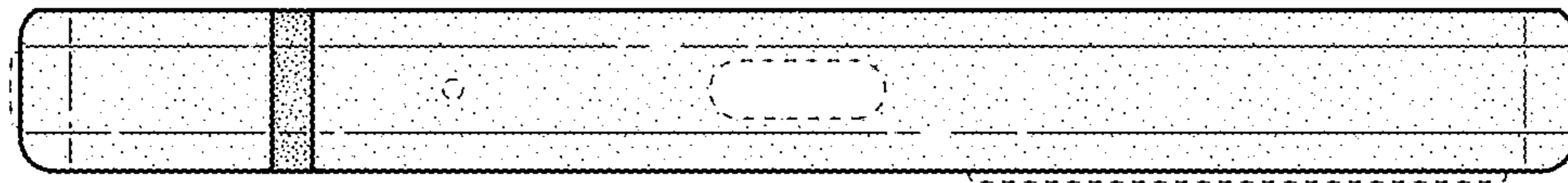

FIG. 28

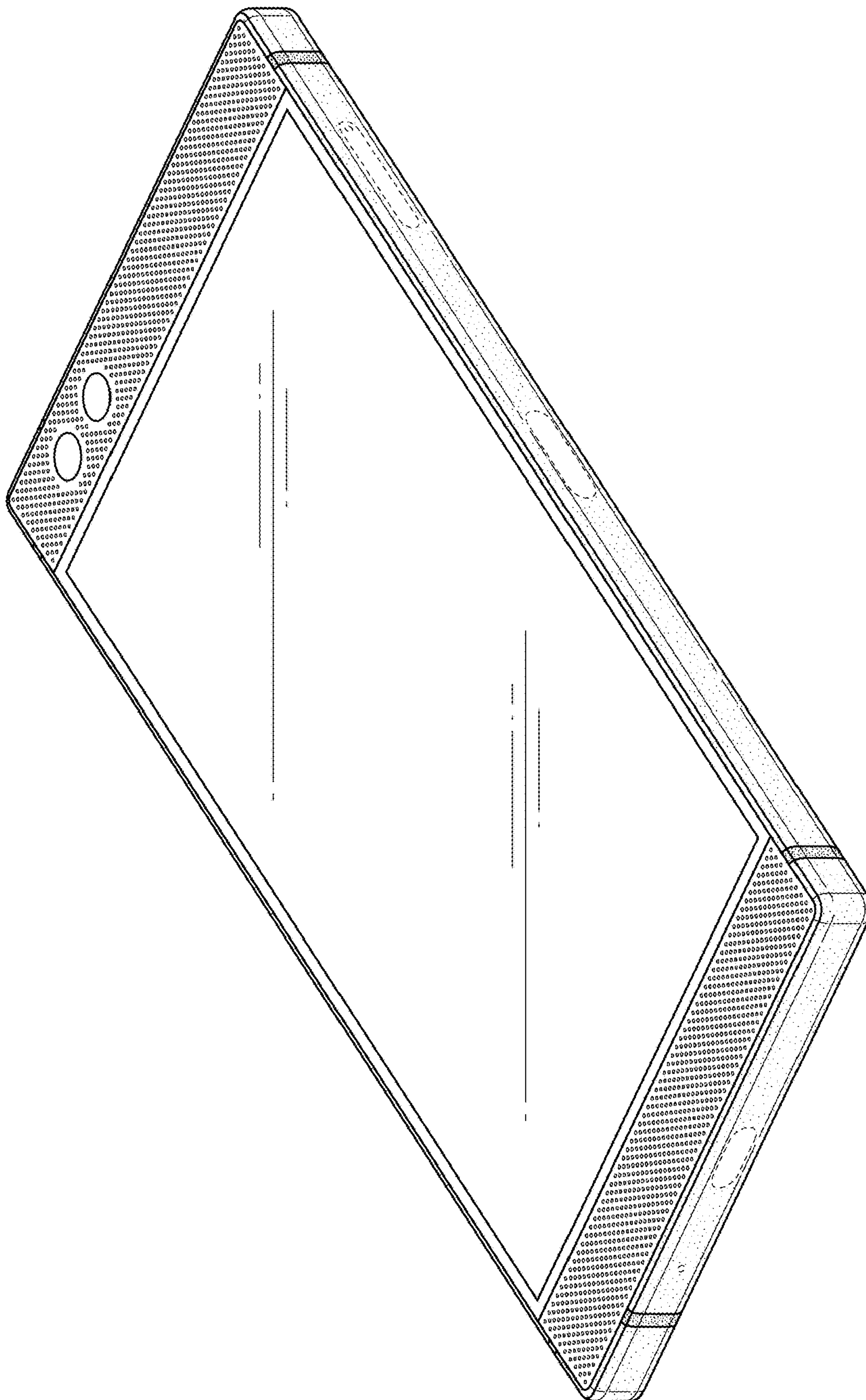

FIG. 29

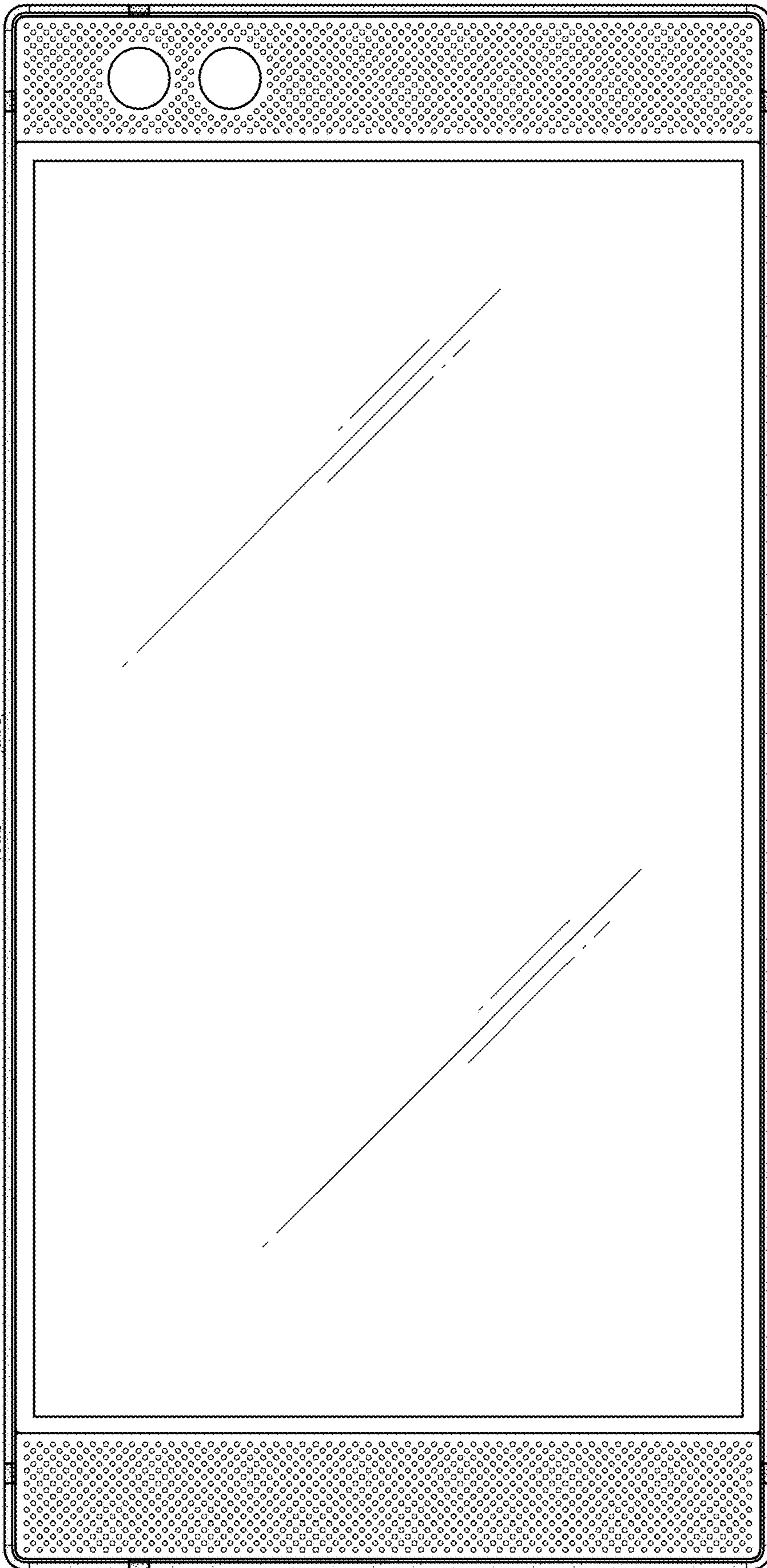

FIG. 30

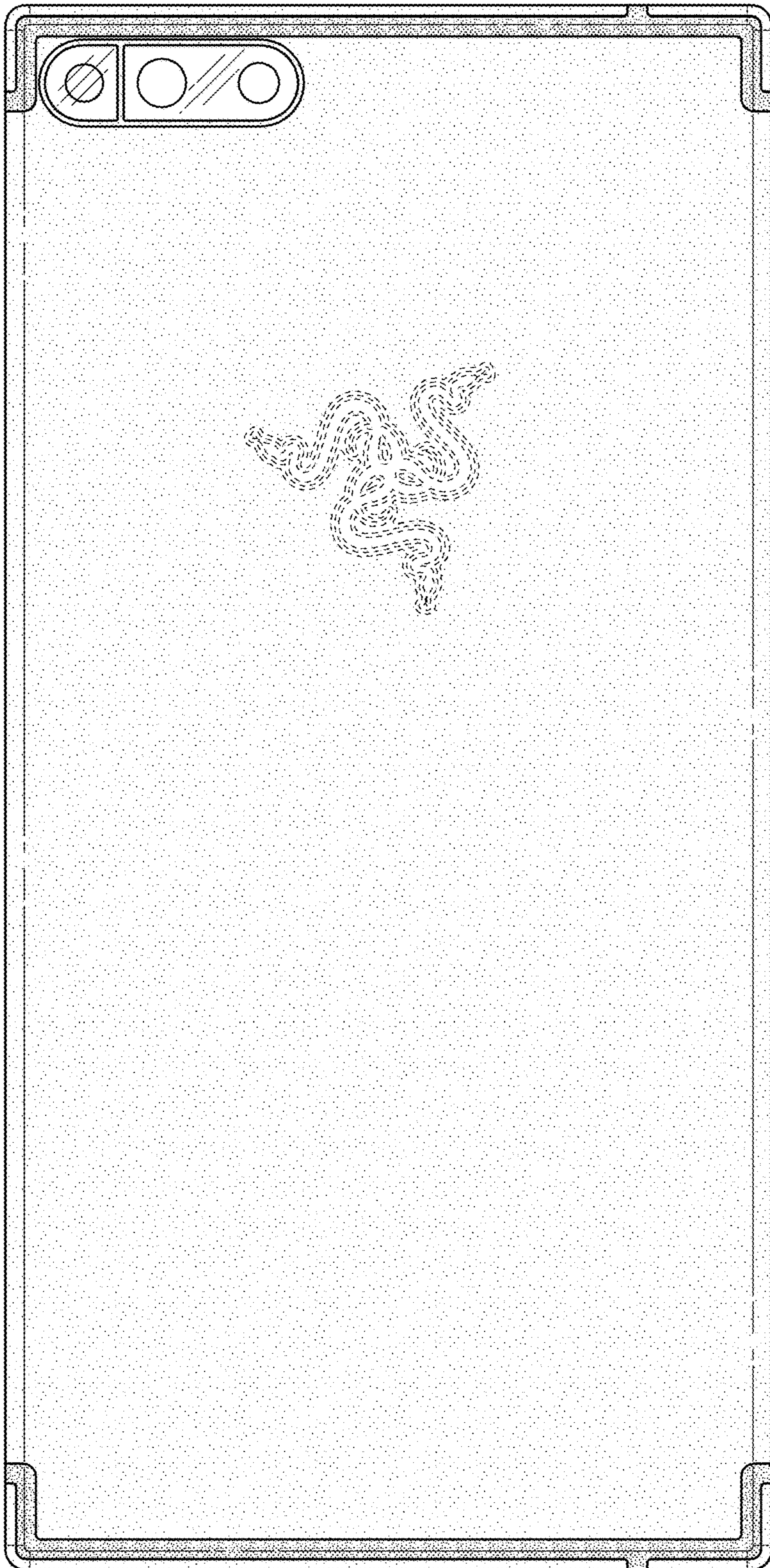

FIG. 31

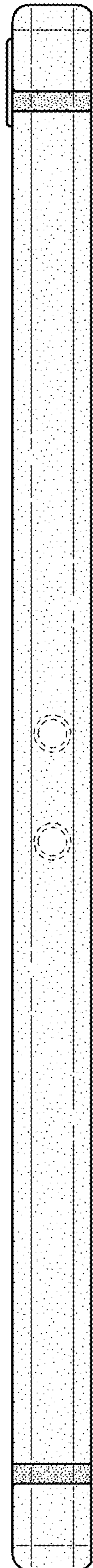

FIG. 32

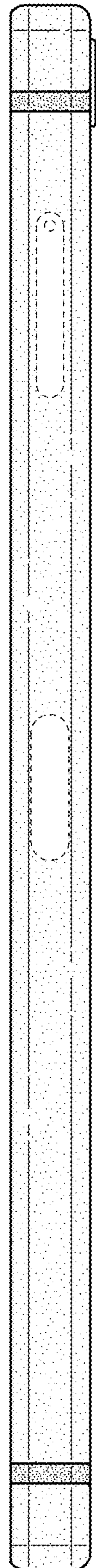

FIG. 33

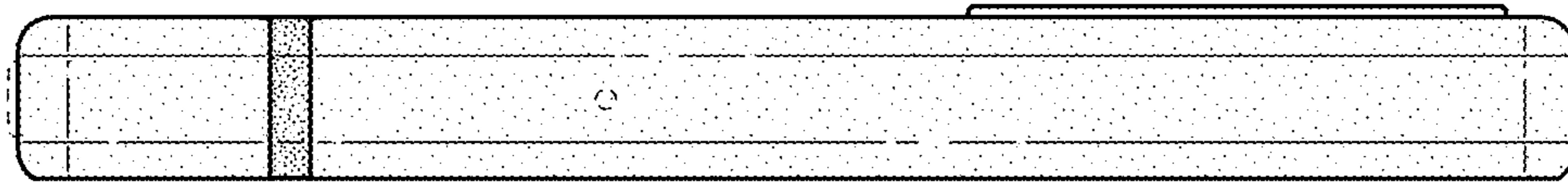

FIG. 34

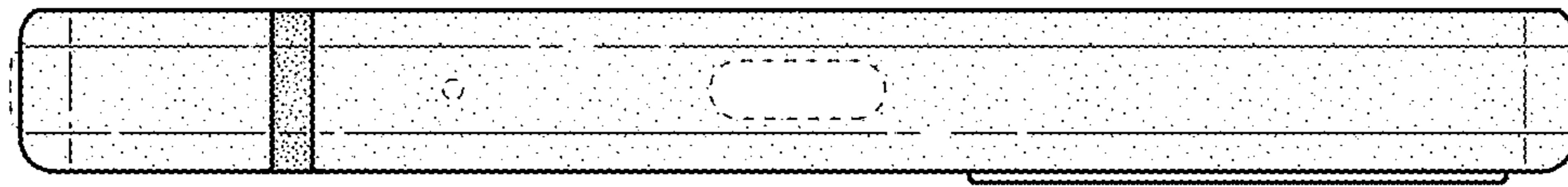

FIG. 35

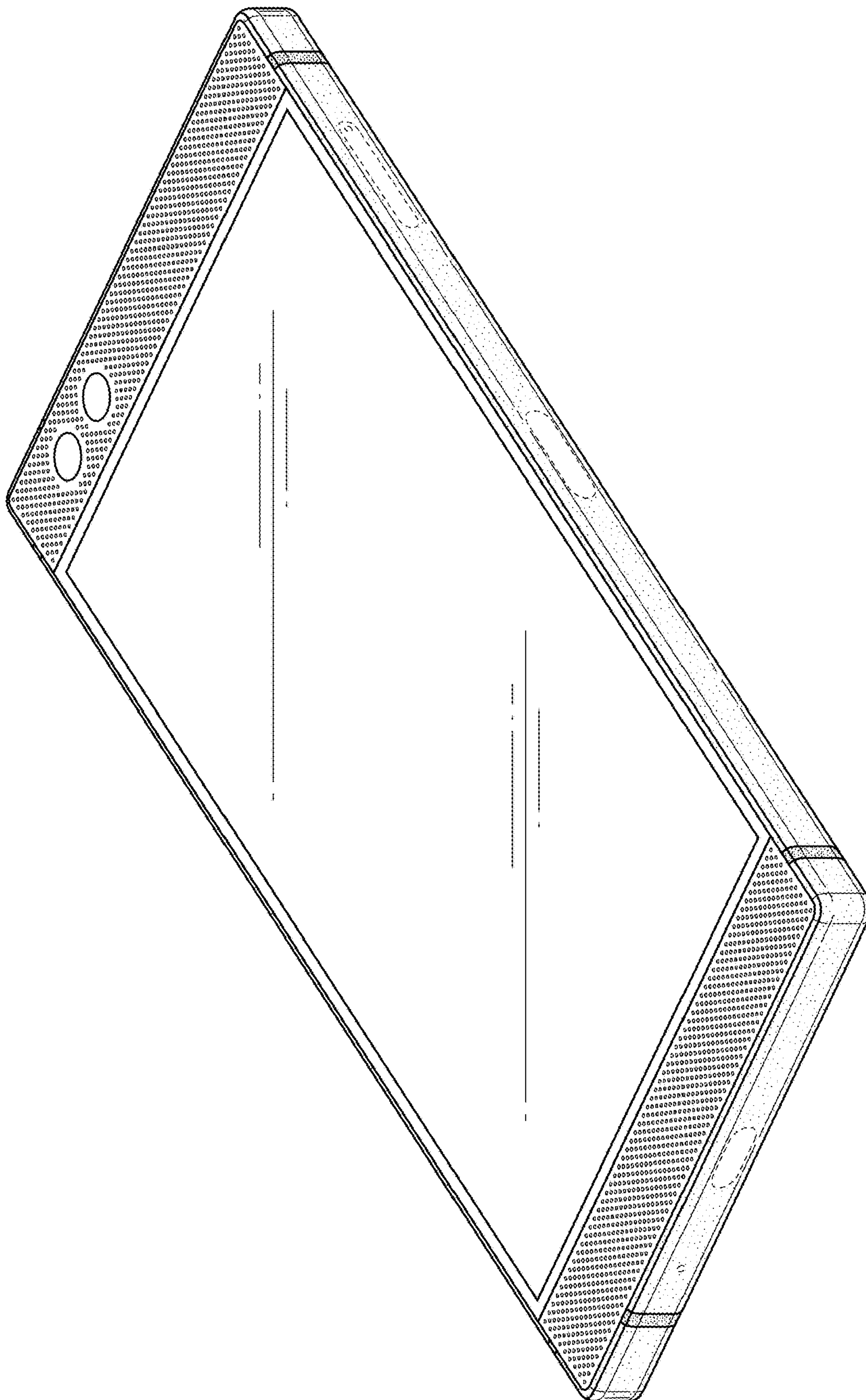

FIG. 36

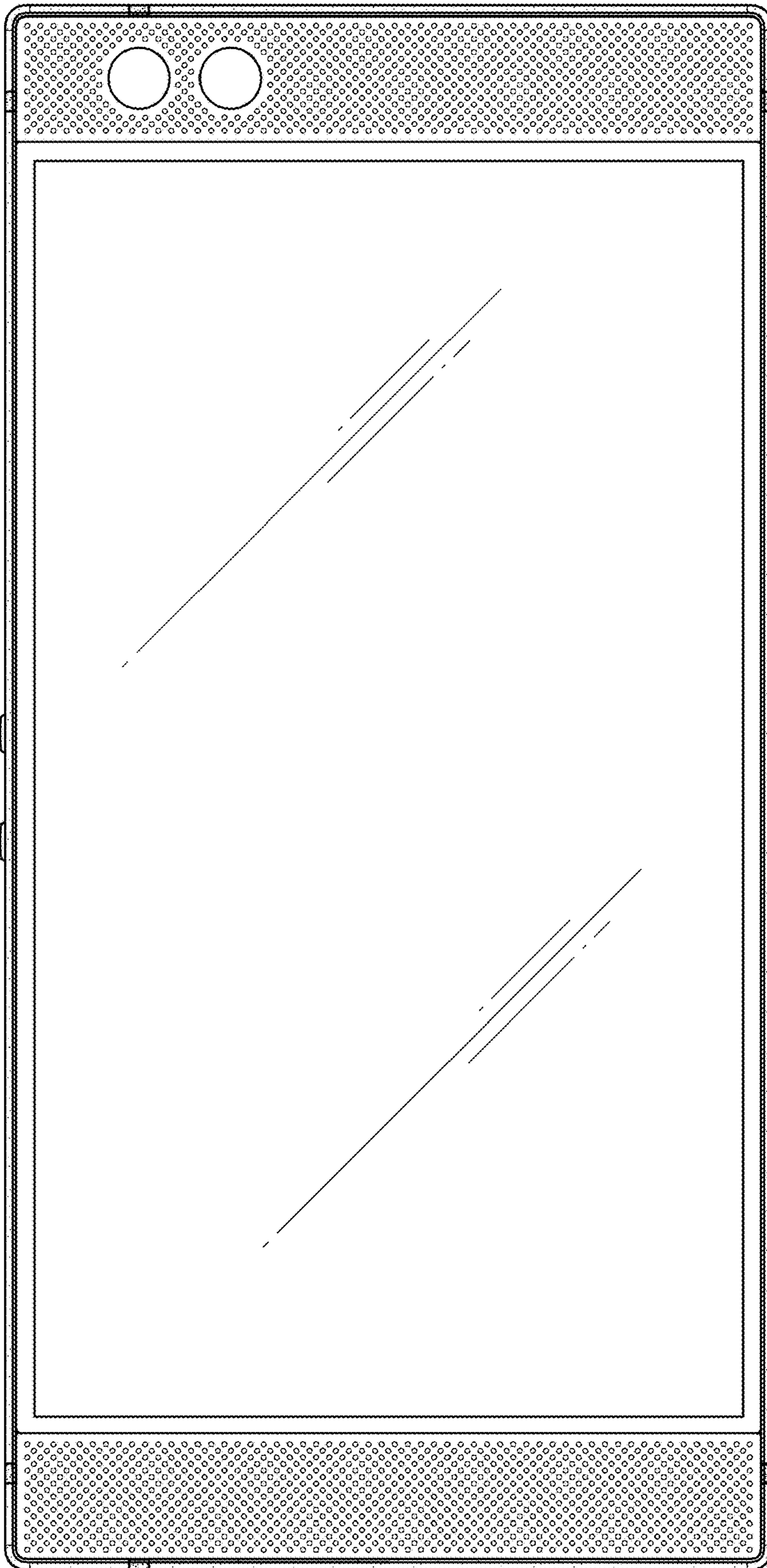

FIG. 37

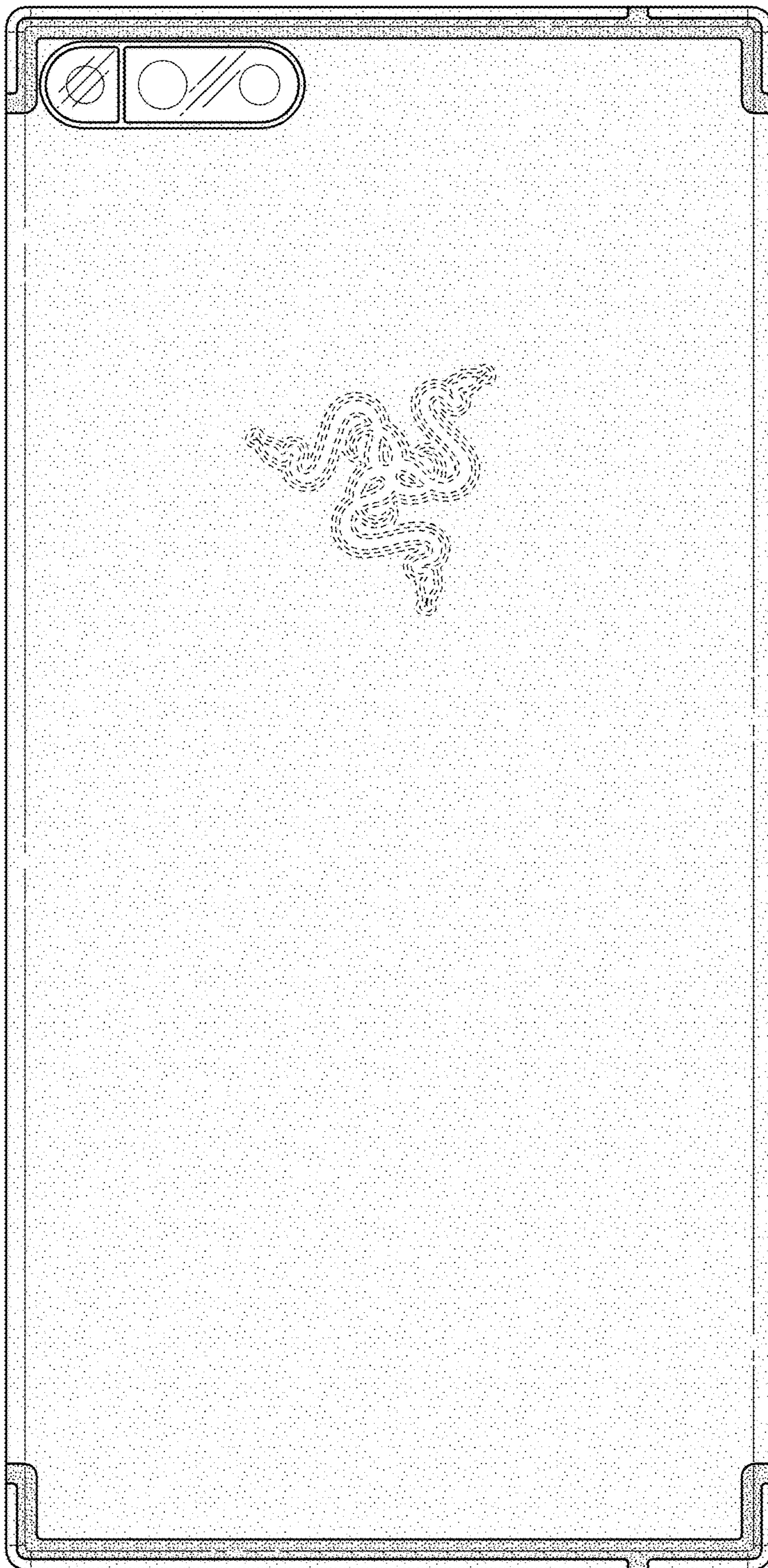

FIG. 38

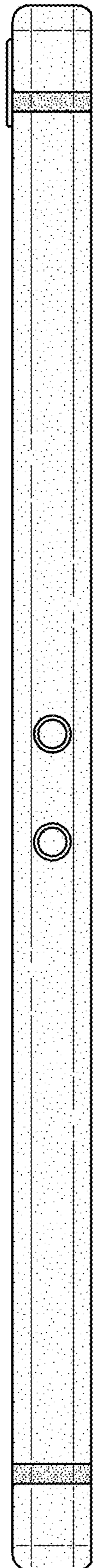

FIG. 39

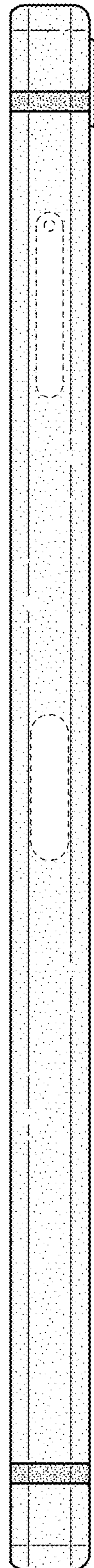

FIG. 40

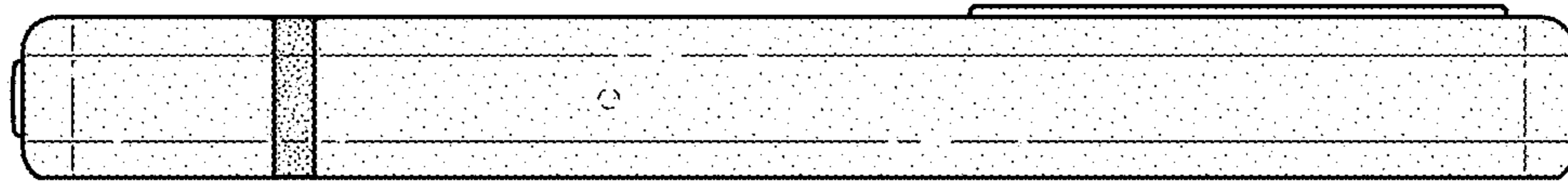

FIG. 41

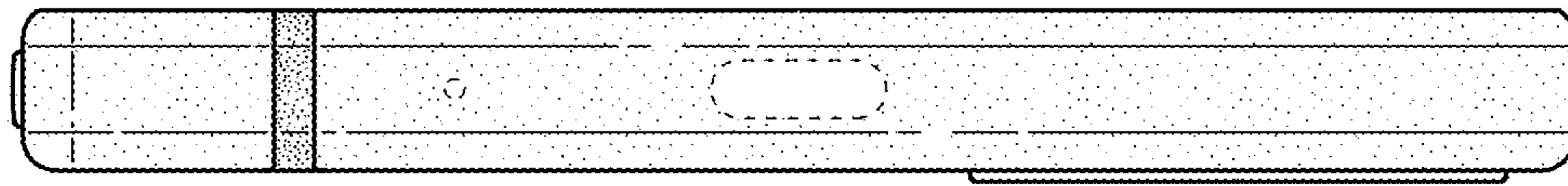

FIG. 42