



US00D896074S

(12) **United States Design Patent**  
**Hudson et al.**

(10) **Patent No.:** **US D896,074 S**  
(45) **Date of Patent:** **\*\* Sep. 15, 2020**

(54) **STORAGE CONTAINER LID**

(71) Applicant: **THE SHERWIN-WILLIAMS COMPANY**, Cleveland, OH (US)

(72) Inventors: **Richard D. Hudson**, North Olmsted, OH (US); **James J. Johnson**, Akron, OH (US); **Gustavo A. Morales**, Brunswick, OH (US)

(73) Assignee: **The Sherwin-Williams Company**, Cleveland, OH (US)

(\*\*) Term: **15 Years**

(21) Appl. No.: **29/703,915**

(22) Filed: **Aug. 30, 2019**

**Related U.S. Application Data**

(63) Continuation of application No. 29/580,170, filed on Oct. 6, 2016, now Pat. No. Des. 863,055, which is a (Continued)

(51) **LOC (12) Cl.** ..... **09-07**

(52) **U.S. Cl.**  
USPC ..... **D9/435**

(58) **Field of Classification Search**  
USPC ..... D7/300–322, 391–396.2, 509–511, 523, D7/589, 598, 612, 615, 619.1; D9/435,  
(Continued)

(56) **References Cited**

**U.S. PATENT DOCUMENTS**

D73,368 S 8/1927 Cavanaugh  
2,019,787 A 11/1935 Leopold  
(Continued)

**FOREIGN PATENT DOCUMENTS**

EP D 162 727 A2 11/1985

**OTHER PUBLICATIONS**

Machin, Alec, Decorate Paints—Alec Machin Design, company website, <<http://www.alecmachindesigns.com/decorate-paints/>>, UK, accessed Mar. 23, 2016.

(Continued)

*Primary Examiner* — Cathron C Brooks

*Assistant Examiner* — Christian P. McLean

(74) *Attorney, Agent, or Firm* — Tucker Ellis LLP; Carlos Garritano; Patrick Clunk

(57) **CLAIM**

The ornamental design for a storage container lid, as shown and described.

**DESCRIPTION**

FIG. 1 is a perspective view of a storage container lid, showing the new design in a non-claimed environment; FIG. 2 is a bottom perspective view of the storage container lid illustrated in FIG. 1;

FIG. 3 is a left side view of the storage container lid illustrated in FIG. 1;

FIG. 4 is a front view of the storage container lid illustrated in FIG. 1;

FIG. 5 is a right side view of the storage container lid illustrated in FIG. 1;

FIG. 6 is a rear view of the storage container lid illustrated in FIG. 1;

FIG. 7 is a top view of the storage container lid illustrated in FIGS. 1; and,

FIG. 8 is a bottom view of the storage container lid illustrated in FIG. 1.

The broken line showing of a storage container in FIG. 1 illustrates the environment of the design and forms no part of the claim. The remaining broken lines in all figures illustrate portions of the storage container lid that form no part of the claimed.

**1 Claim, 4 Drawing Sheets**

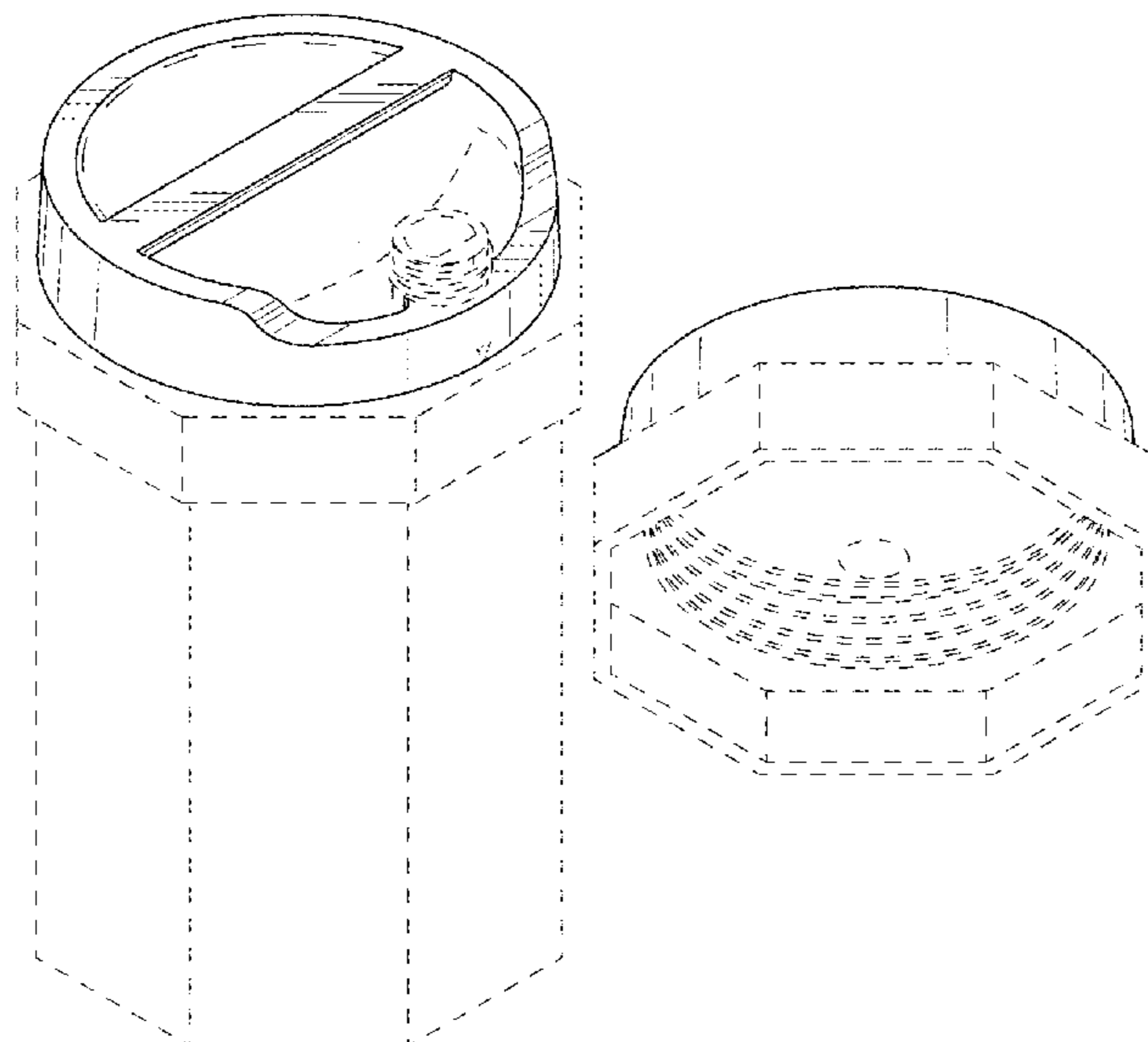

**Related U.S. Application Data**

continuation-in-part of application No. 29/558,788,  
filed on Mar. 21, 2016, now abandoned.

(58) **Field of Classification Search**

USPC ..... D9/436, 439, 440, 443, 447, 454, 500,  
D9/503-505, 516-575, 763-783;  
215/40-55, 316-354, 370-385;  
220/574-575

CPC ..... B65D 1/00; B65D 1/02; B65D 1/0223;  
B65D 1/023; B65D 1/0276

See application file for complete search history.

(56) **References Cited**

U.S. PATENT DOCUMENTS

2,713,938	A	7/1955	Snyder	
2,819,833	A	1/1958	Sauer	
3,204,849	A	9/1965	Vinney	
D206,306	S	11/1966	Helms	
4,205,775	A	6/1980	Swan	
D268,385	S	3/1983	Sinopoli	
4,623,063	A	11/1986	Balkin	
D309,511	S *	7/1990	Bertlin	D28/78
D314,066	S *	1/1991	Bakic	D28/77
D318,144	S *	7/1991	Scarpa	D28/78
D328,168	S	7/1992	Bartle	
D328,706	S	8/1992	Ruff	
D334,805	S	4/1993	Ivey	
D385,186	S	10/1997	Fildan	
D393,999	S	5/1998	Gruenbacher et al.	
5,775,571	A	7/1998	Edelman	
D411,079	S	6/1999	Graham	
6,161,696	A	12/2000	Lashley	
6,412,686	B1	7/2002	Mahl	
6,415,927	B1	7/2002	Stone	
D465,726	S	11/2002	Tet	
D474,682	S	5/2003	Berman	
D474,683	S	5/2003	Berman	
D489,605	S	5/2004	Berman	
D490,310	S	5/2004	Aggenberg	
D532,703	S	11/2006	Wild	
D552,982	S *	10/2007	Liebe	D28/78
D563,797	S	3/2008	McMorris	
D583,255	S	12/2008	Castor	
D585,763	S	2/2009	Friebe et al.	

D599,676	S	9/2009	Friebe et al.	
D602,669	S	10/2009	Gardner	
D650,274	S	12/2011	Neumann	
D679,148	S	4/2013	Schwartz	
9,290,310	B2	3/2016	Sinn et al.	
D756,037	S	5/2016	Schlatter	
D771,832	S *	11/2016	Yeager	D24/224
D772,056	S	11/2016	O'Dowd	
D783,306	S	4/2017	Gal	
D786,668	S	5/2017	Comaglia	
D812,427	S *	3/2018	Barber	D7/510
D821,746	S	7/2018	Heyman	
D822,482	S	7/2018	Dib	
D838,175	S	1/2019	Giannantonio	
D839,738	S *	2/2019	Hudson	D9/454
D840,238	S	2/2019	Hudson	
D842,105	S *	3/2019	Willemstyn	D9/436
D846,993	S	4/2019	Nguyen	
D862,225	S *	10/2019	Horn	B65D 25/20 D9/436
D863,055	S *	10/2019	Hudson	D9/430
D863,686	S *	10/2019	Min	D28/83
D864,672	S *	10/2019	Callinan	D7/608
D865,296	S *	10/2019	Min	D28/83
2005/0067476	A1	3/2005	Hengami	
2010/0147865	A1 *	6/2010	Yang	B65F 1/04 220/810
2010/0301108	A1 *	12/2010	Wisecarver	B65D 5/029 229/174
2015/0083715	A1	3/2015	Shuert	
2015/0102041	A1 *	4/2015	Lee	A47G 19/30 220/575
2017/0233160	A1	8/2017	Hudson	
2017/0273438	A1 *	9/2017	Liu	A45D 33/003

OTHER PUBLICATIONS

Muoio, Danielle, "Redesigning the Paint Can to Save Millions of Gallons of Paint", Bloomberg Business, Aug. 8, 2014, US <<https://www.bloomberg.com/news/articles/2014-08-08/redesigning-paint>>, accessed Mar. 23, 2016.  
Alibaba.com; Octagon cardboard candy packaging box with clear pvc window; 1 page.  
Amazon.com; (4 pack) Chefland 6x6 drip tray black pastic octagonal shape; 4 pages.

\* cited by examiner

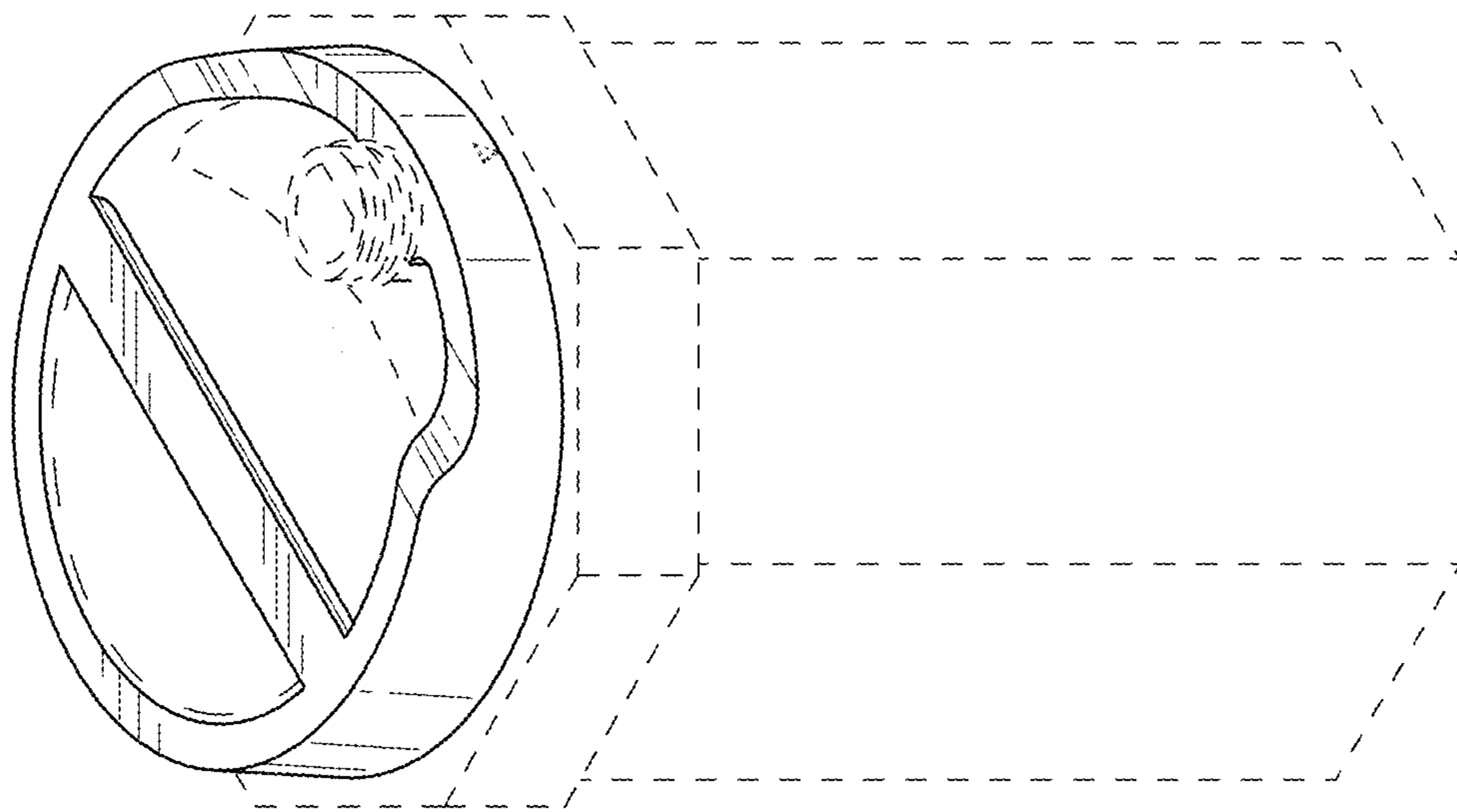

**FIG. 1**

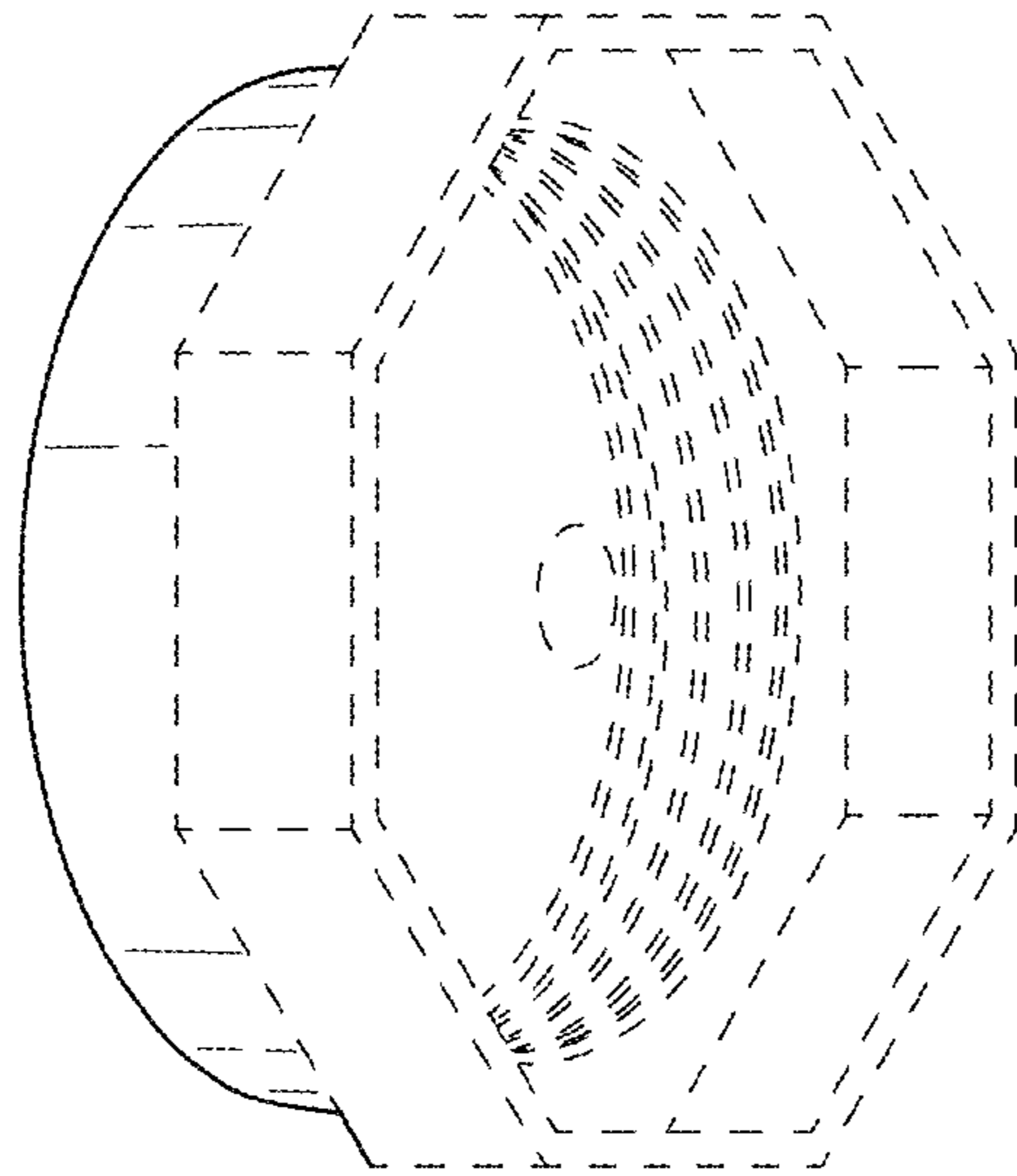

**FIG. 2**

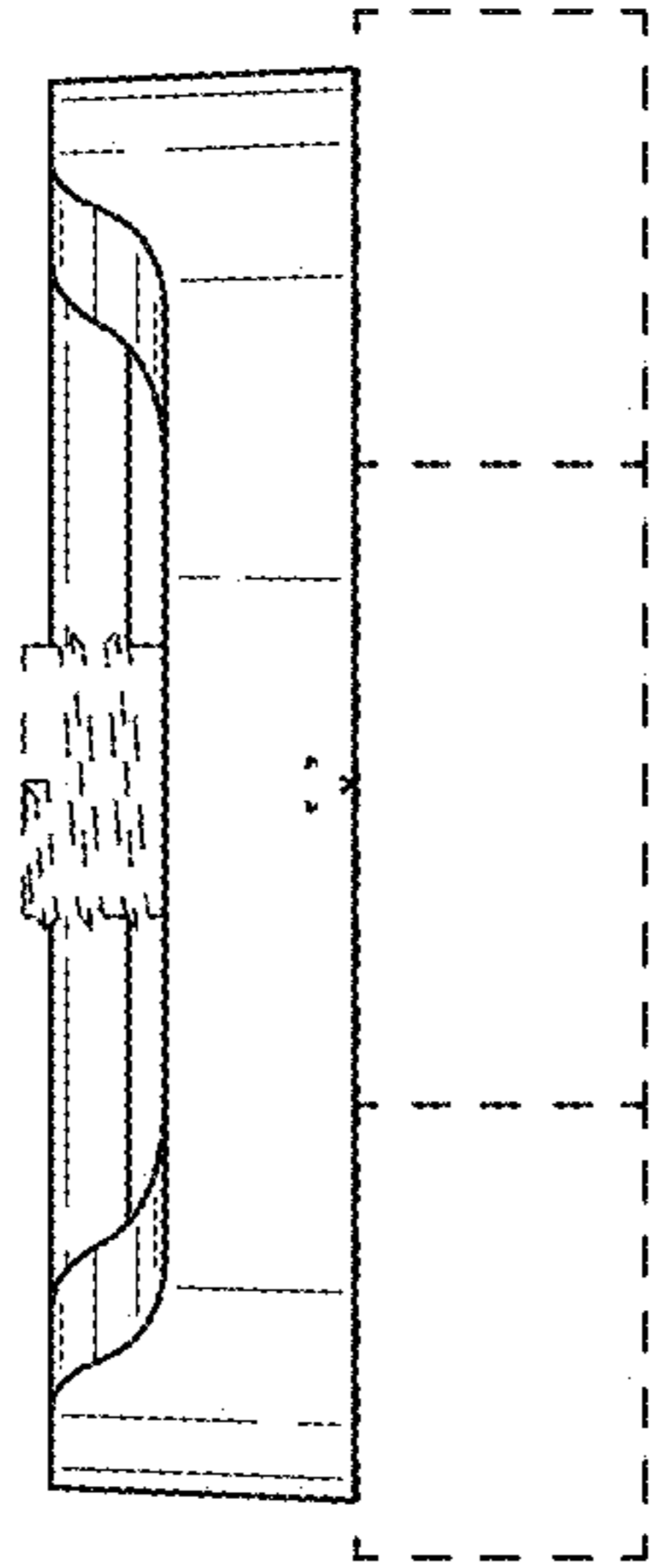

FIG. 3

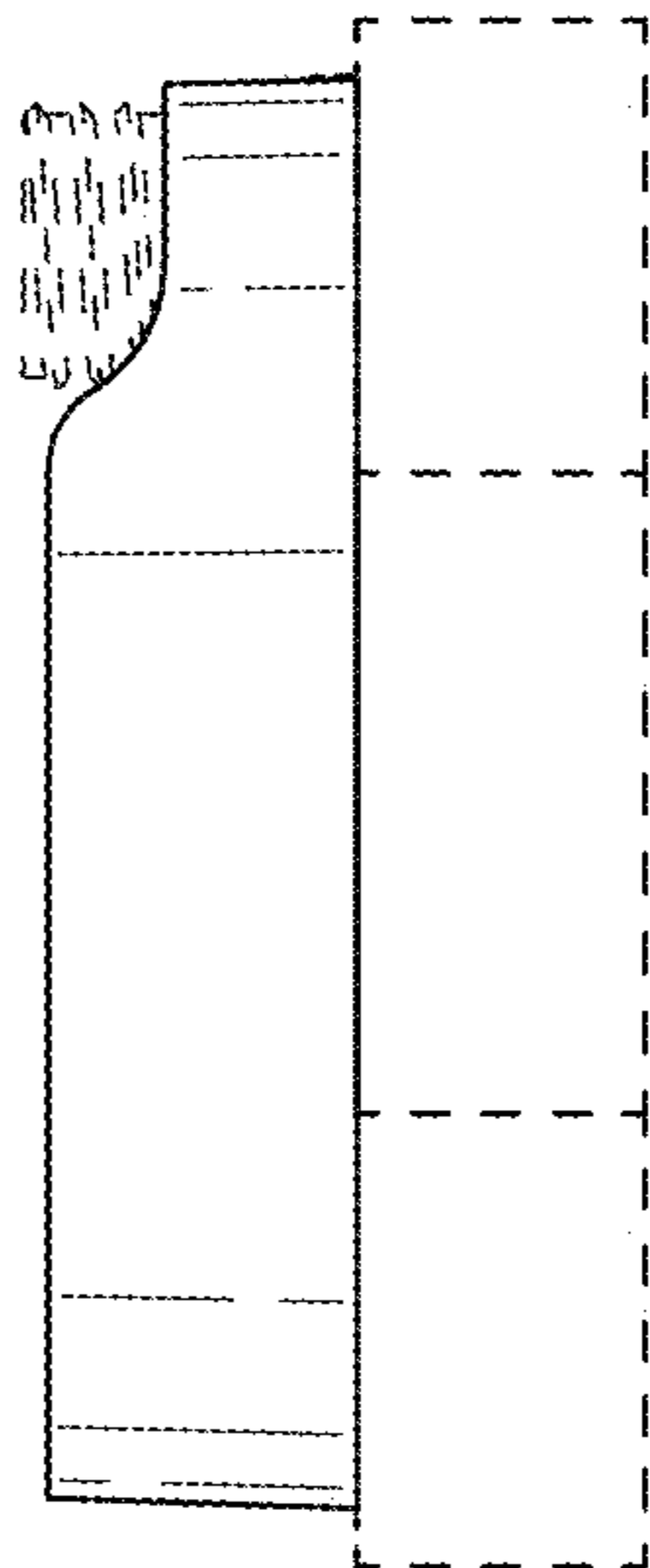
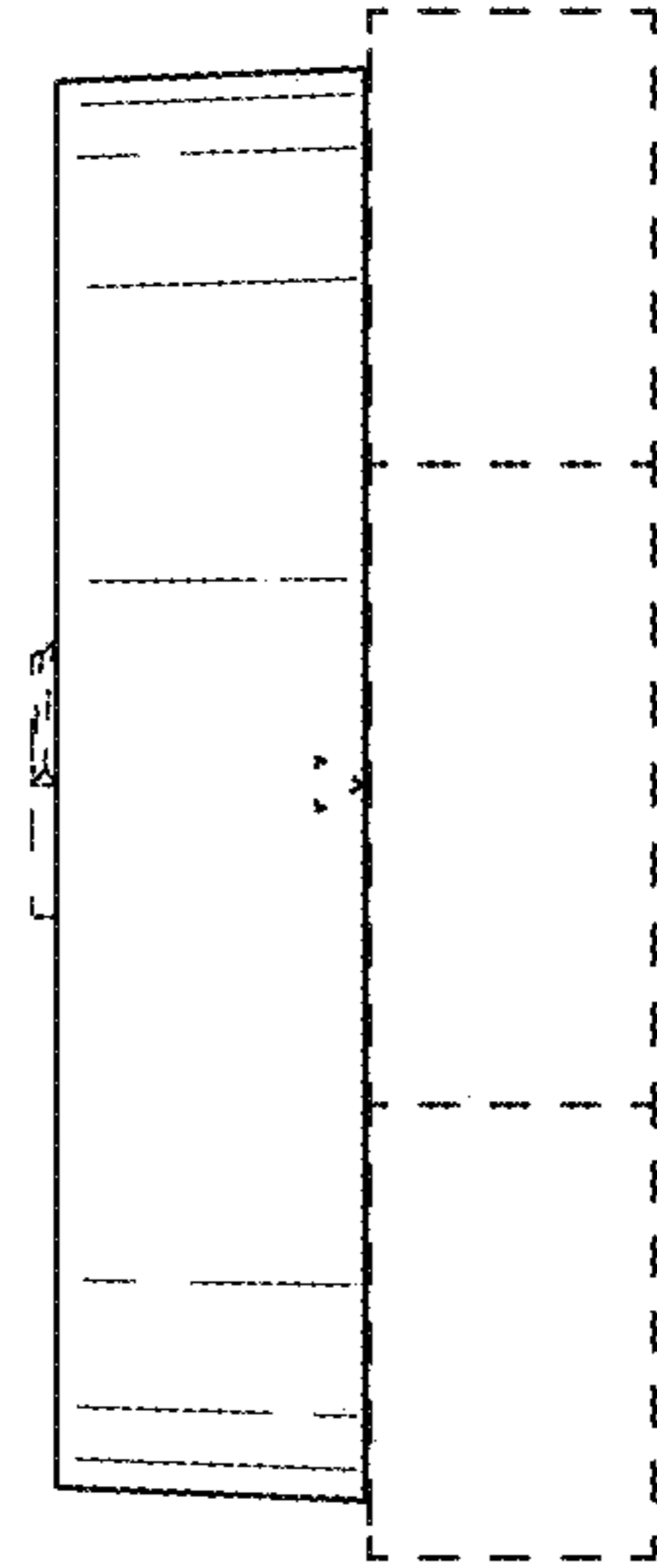
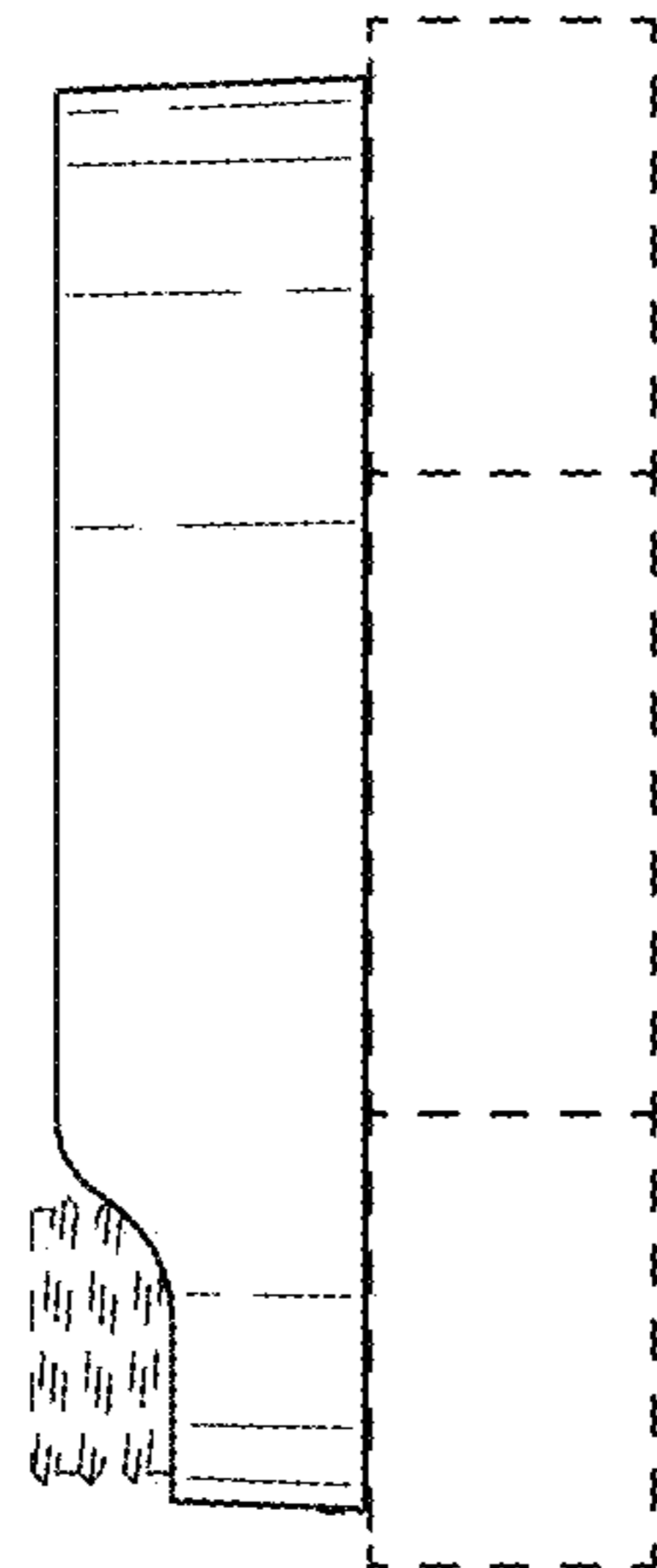

FIG. 4



**FIG. 5**



**FIG. 6**

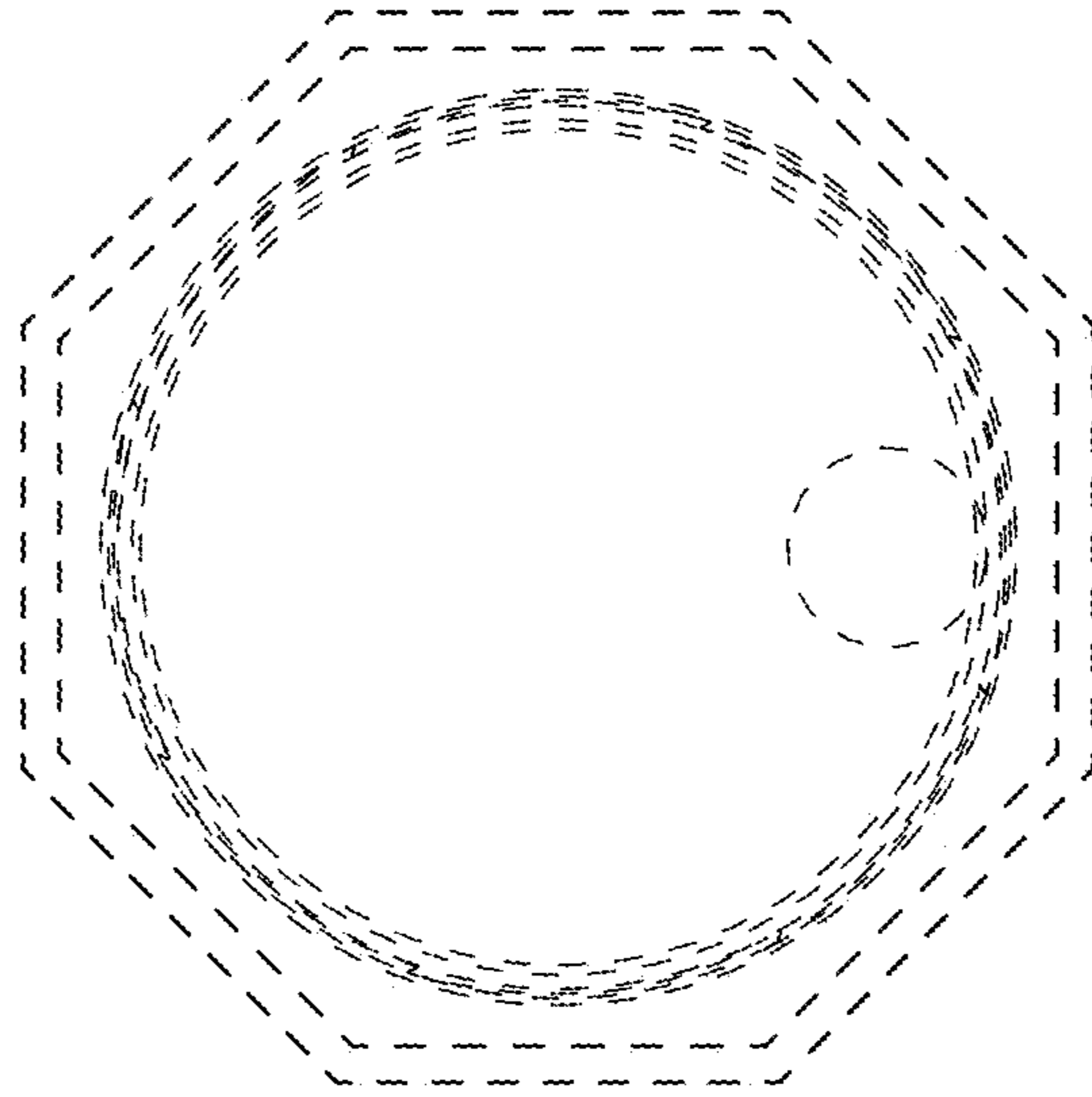

FIG. 8

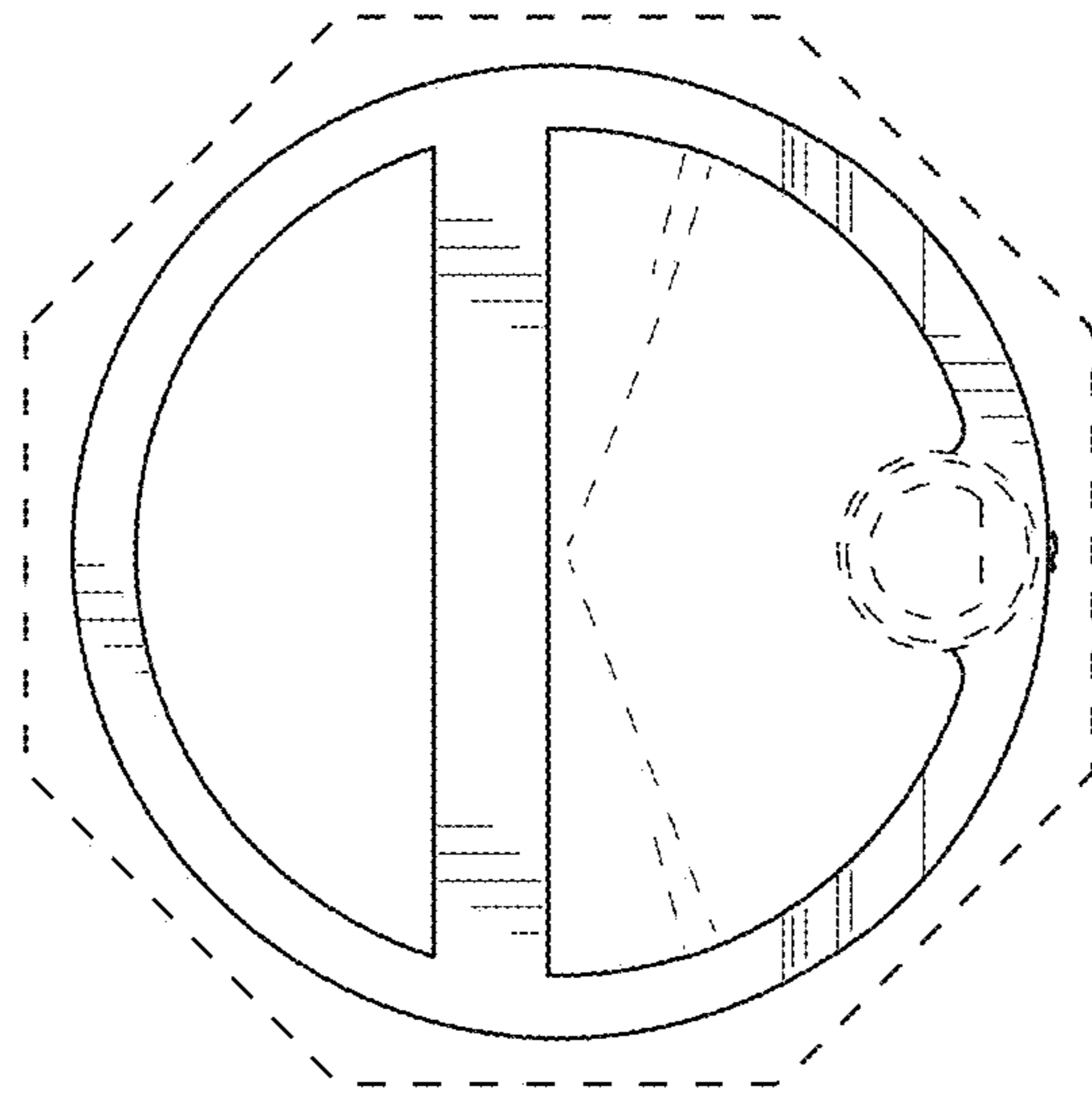

FIG. 7