



US00D895995S

(12) **United States Design Patent**  
**Killinger**

(10) **Patent No.:** **US D895,995 S**

(45) **Date of Patent:** **\*\* \*Sep. 15, 2020**

(54) **CHAIR**

(71) Applicant: **Williams-Sonoma, Inc.**, San Francisco, CA (US)

(72) Inventor: **James Ian Killinger**, Brooklyn, NY (US)

(73) Assignee: **Williams-Sonoma, Inc.**, San Francisco, CA (US)

(\*) Notice: This patent is subject to a terminal disclaimer.

(\*\*) Term: **15 Years**

(21) Appl. No.: **29/663,557**

(22) Filed: **Sep. 17, 2018**

(51) **LOC (12) Cl.** ..... **06-01**

(52) **U.S. Cl.**  
USPC ..... **D6/374**

(58) **Field of Classification Search**  
USPC ..... D6/334, 335, 349, 370-376, 379, 380  
CPC .... A47C 1/00; A47C 3/00; A47C 3/04; A47C 3/12; A47C 5/04; A47C 5/14; A47C 7/02; A47C 7/16; A47C 7/18; A47C 7/24; A47C 7/36; A47C 7/40

See application file for complete search history.

(56) **References Cited**

**U.S. PATENT DOCUMENTS**

D386,909 S *	12/1997	Mourgue	.....	D6/334
D569,647 S *	5/2008	Mezger	.....	D6/374
D716,064 S *	10/2014	George, II	.....	D6/334
D730,097 S *	5/2015	Kubryk	.....	D6/716
D746,609 S *	1/2016	Lievore	.....	D6/375
D751,838 S *	3/2016	Ciani	.....	D6/381
D794,349 S *	8/2017	Levy	.....	D6/374
D798,068 S *	9/2017	Iqbal	.....	D6/334

D807,066 S *	1/2018	Vance	.....	D6/334
D815,449 S *	4/2018	Hannoosh	.....	D6/374
D815,452 S *	4/2018	Hannoosh	.....	D6/380
D836,360 S *	12/2018	Novak	.....	D6/375
D836,934 S *	1/2019	Guffler	.....	D6/380

**OTHER PUBLICATIONS**

Target. <https://www.target.com/p/sanibel-blush-channel-tufted-velvet-accent-chair-pink-abbyson-living/-/A-54191716>. "Sanibel Blush Channel Tufted Velvet Accent Chair Pink". Date Unknown: Viewed Aug. 2019 (Year: 2019).\*

1stopbedrooms. <https://www.1stopbedrooms.com/red-accent-chair-460407>. "Red Accent Chair". Date unknown: Viewed Aug. 2019 (Year: 2019).\*

Carvana Furniture. <http://carvanafurniture.com/product/mid-century-modern-accent-chair/>. "Mid-Century Modern Accent Chair". Date unknown: Viewed Aug. 2019 (Year: 2019).\*

\* cited by examiner

*Primary Examiner* — R. Johnson

(74) *Attorney, Agent, or Firm* — Cook Alex Ltd.; R. Blake Johnston

(57) **CLAIM**

The ornamental design for a chair, as shown and described.

**DESCRIPTION**

FIG. 1 is a perspective view of the chair; FIG. 2 is a front elevational view of the chair; FIG. 3 is a rear elevational view of the chair; FIG. 4 is a left side elevational view of the chair, the opposite side of which is a mirror image; FIG. 5 is a top plan view of the chair; and, FIG. 6 is a bottom plan view of the chair.

**1 Claim, 5 Drawing Sheets**

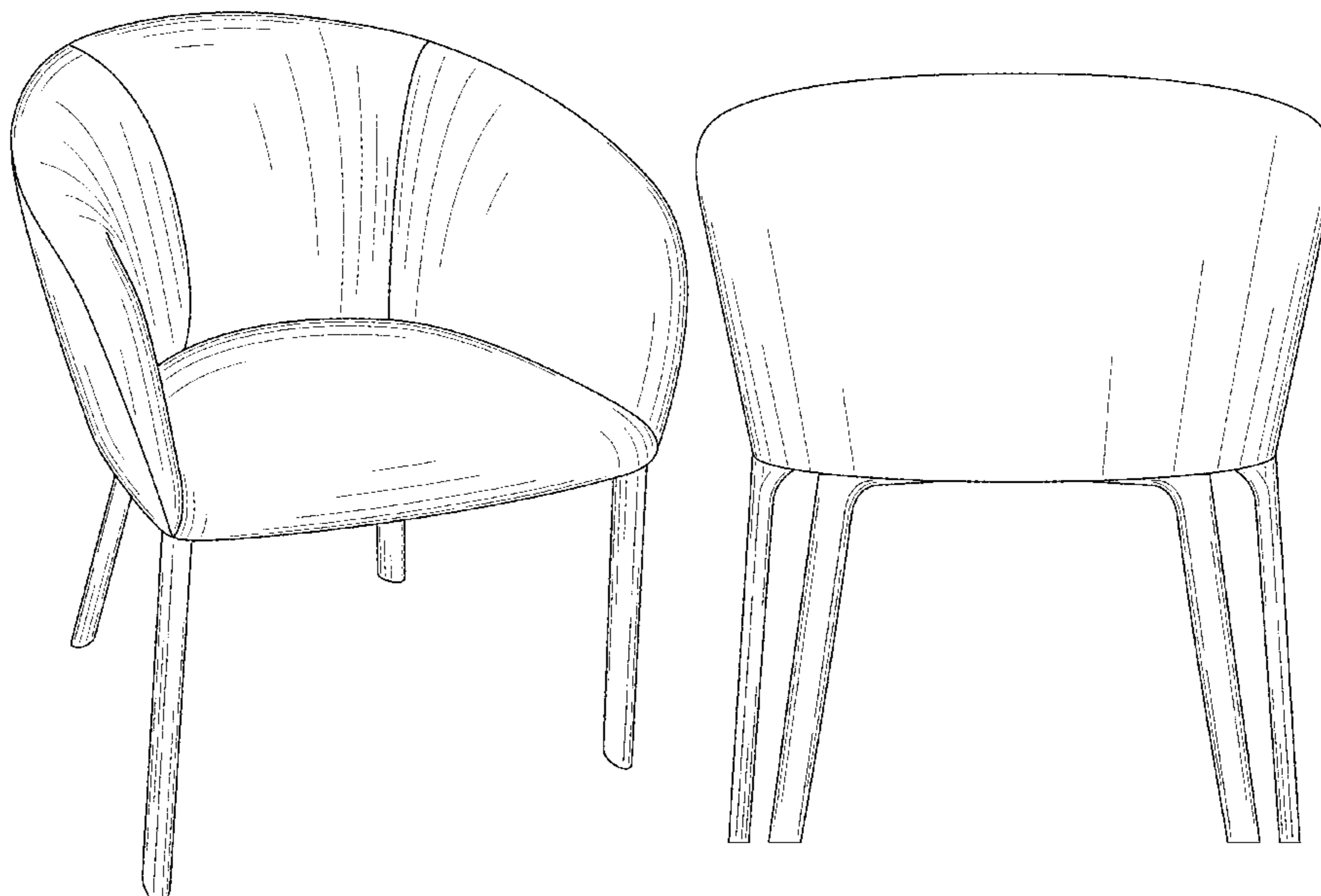

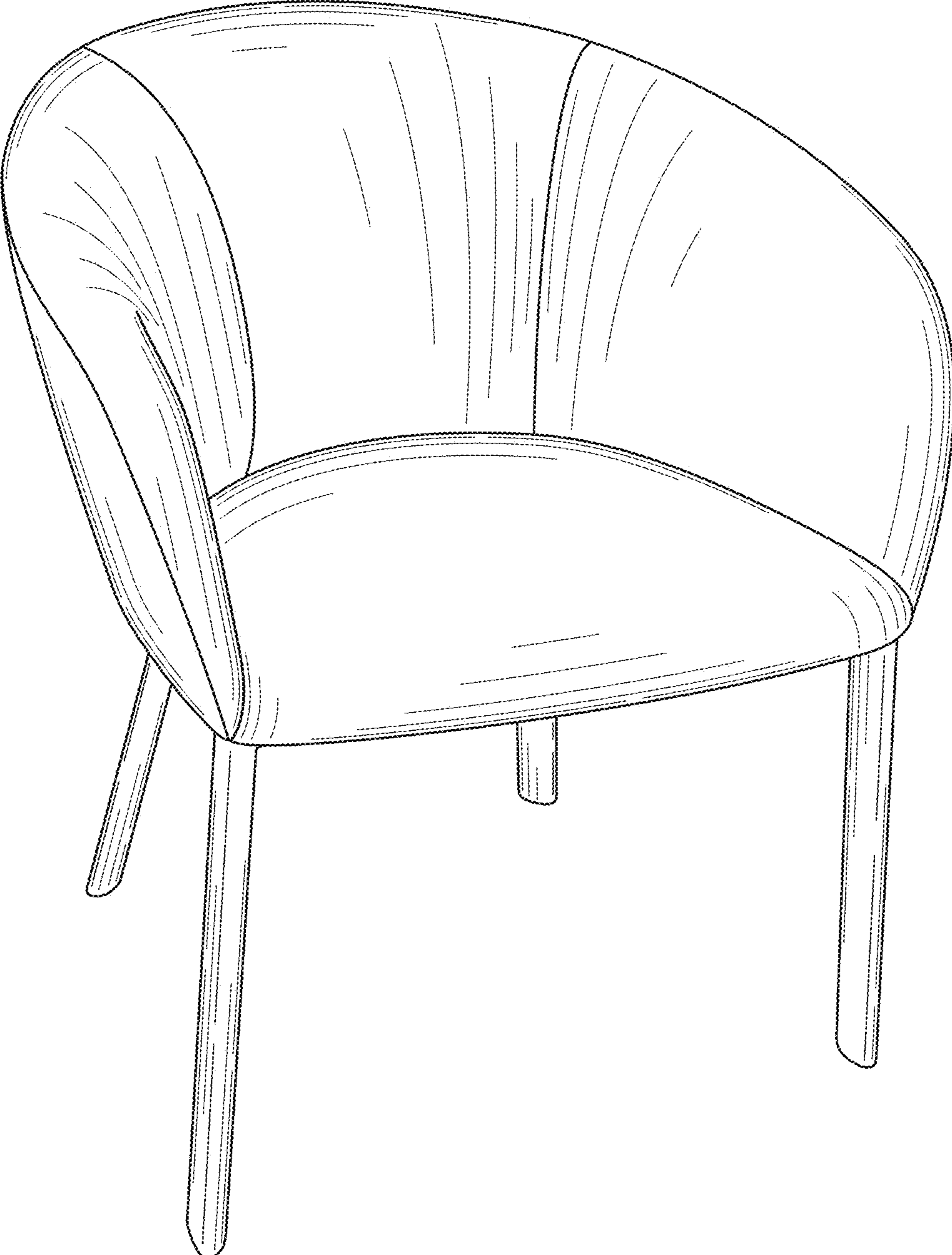

FIG. 1

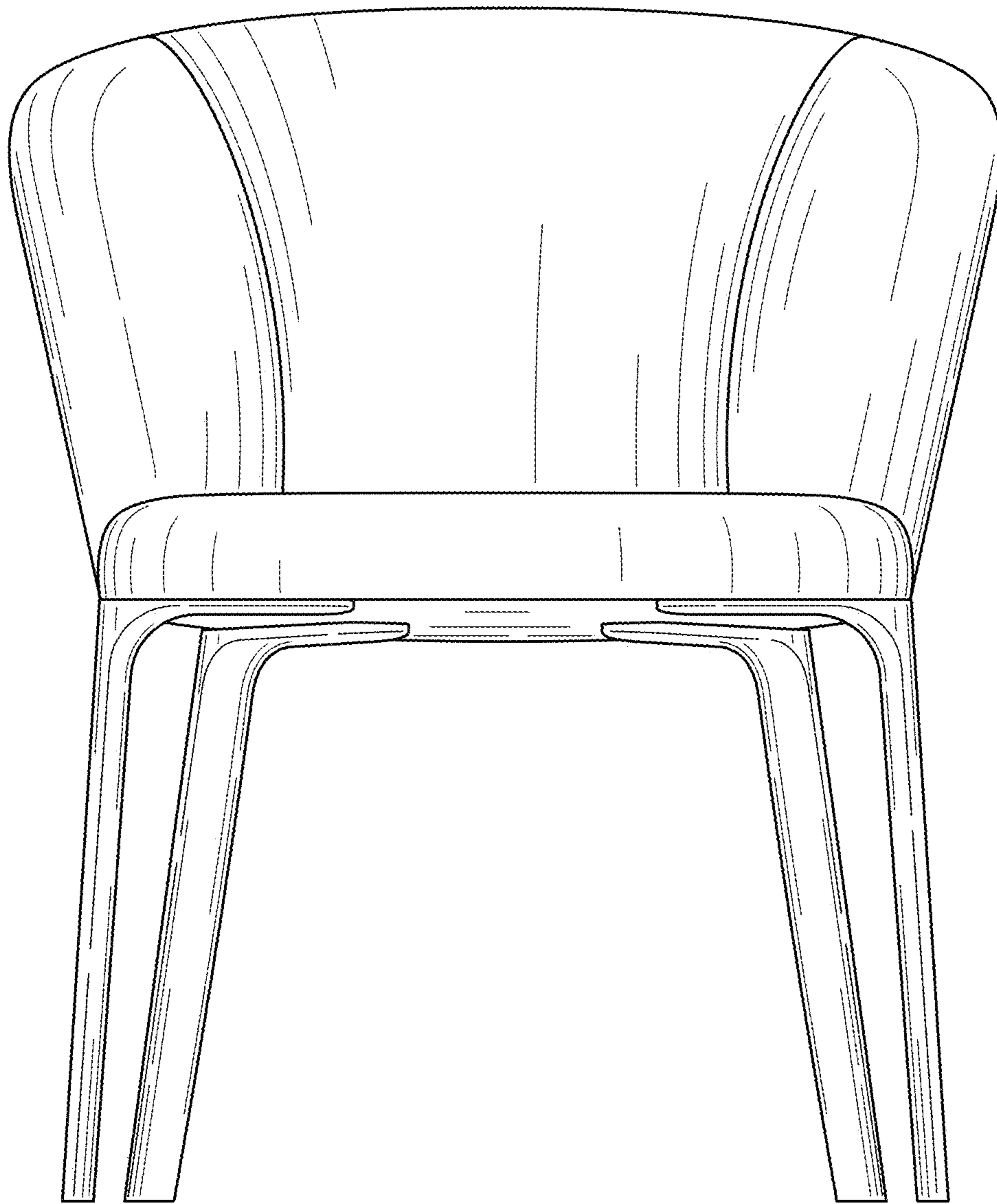

FIG. 2

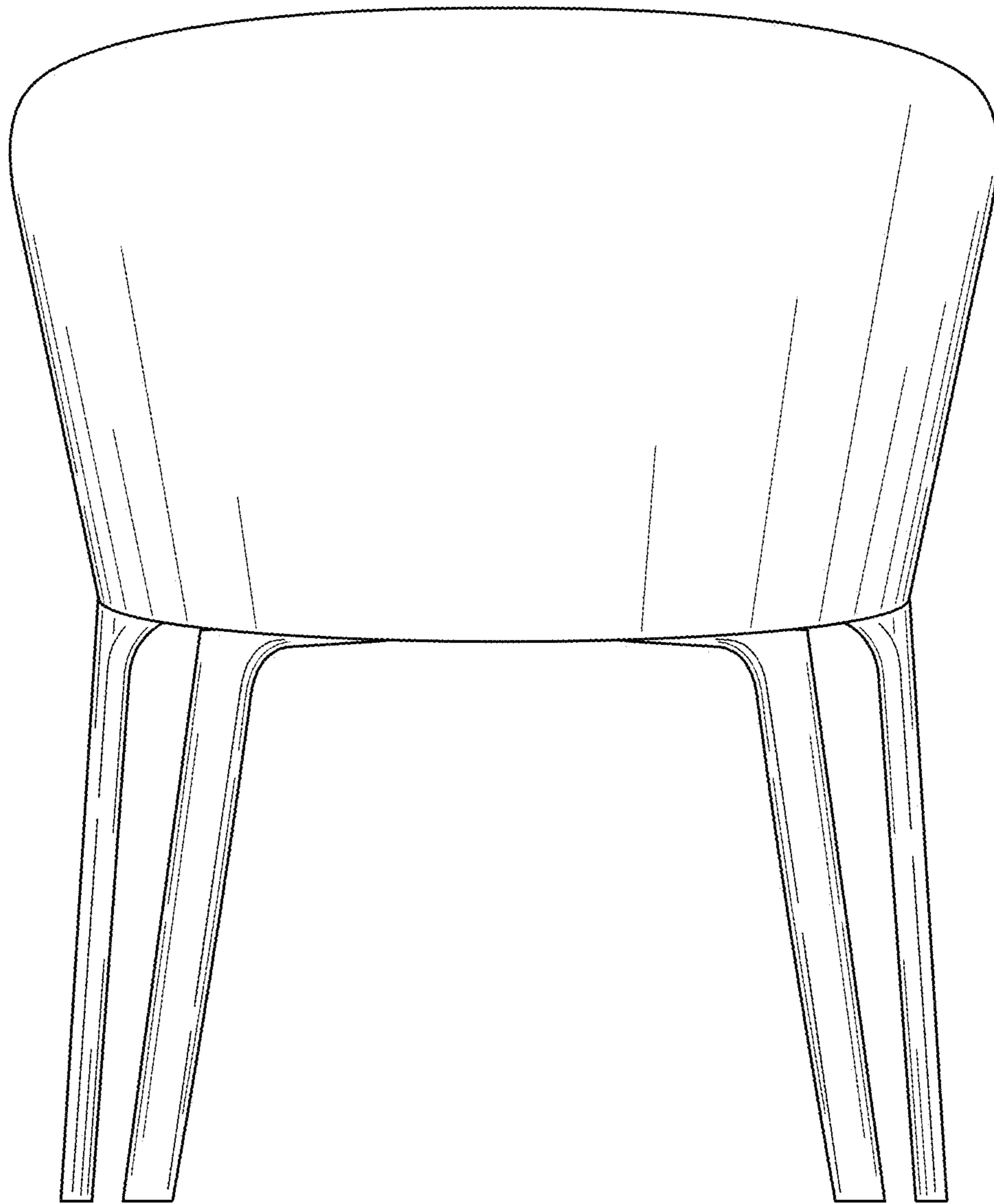

FIG. 3

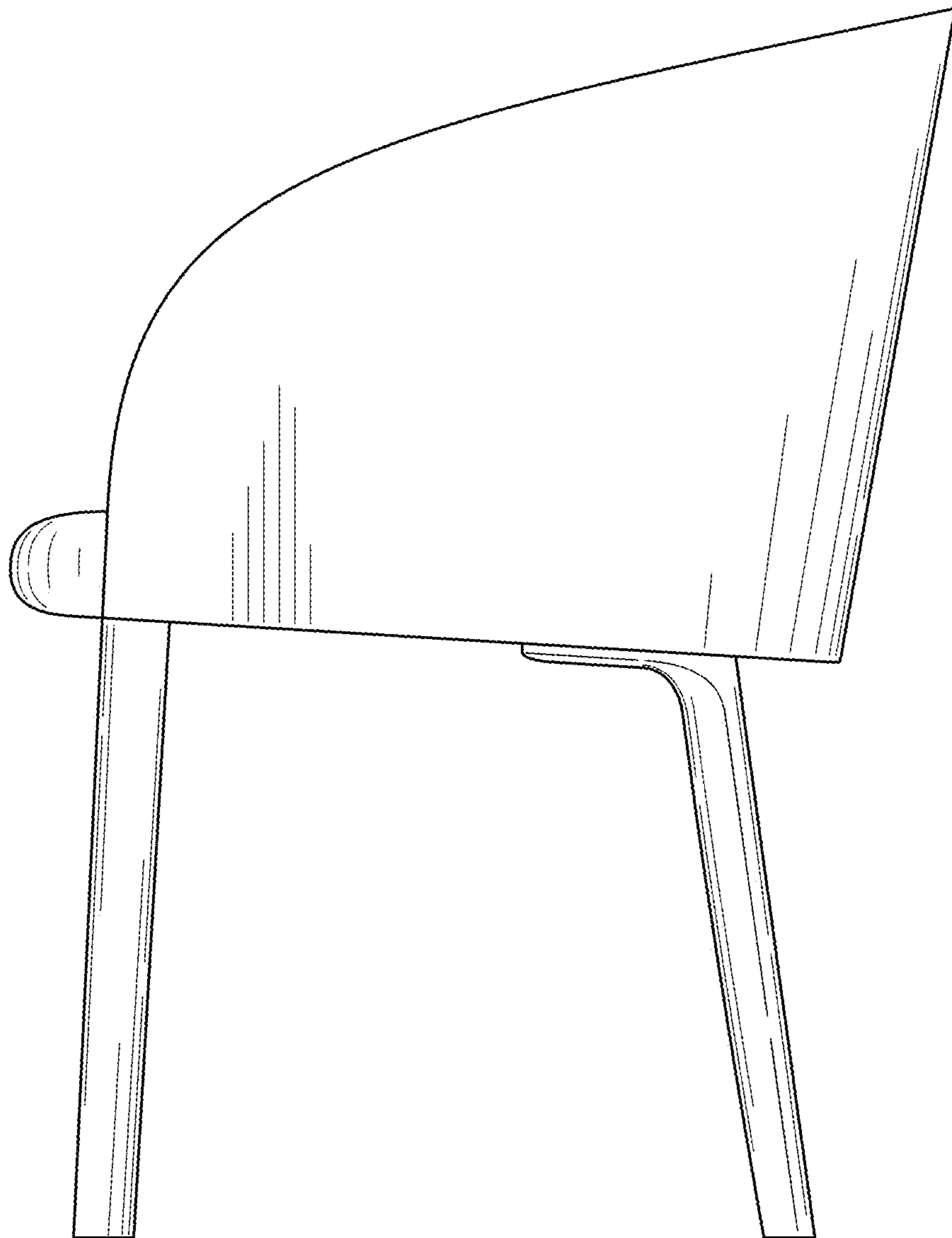

FIG. 4

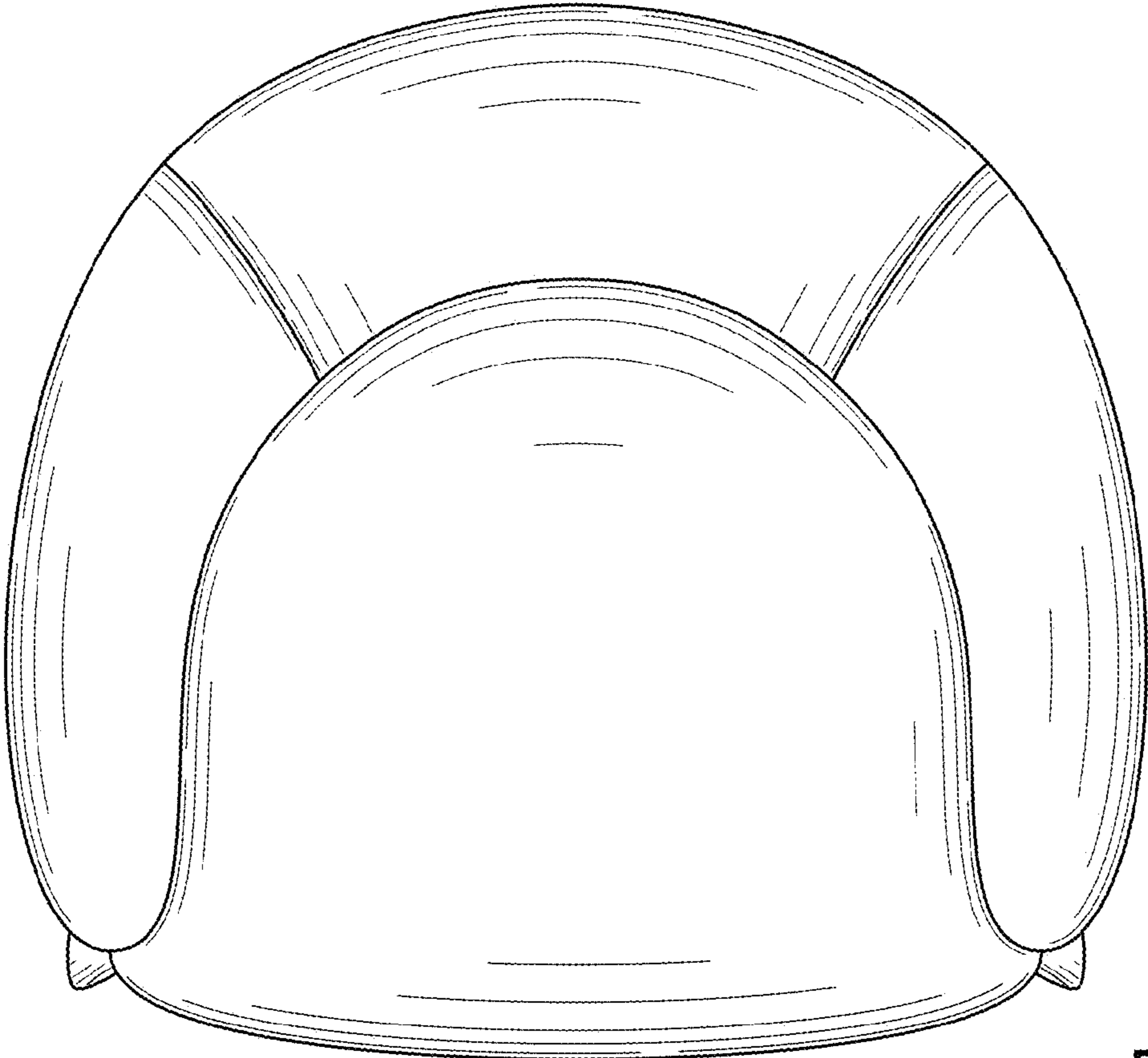

FIG. 5

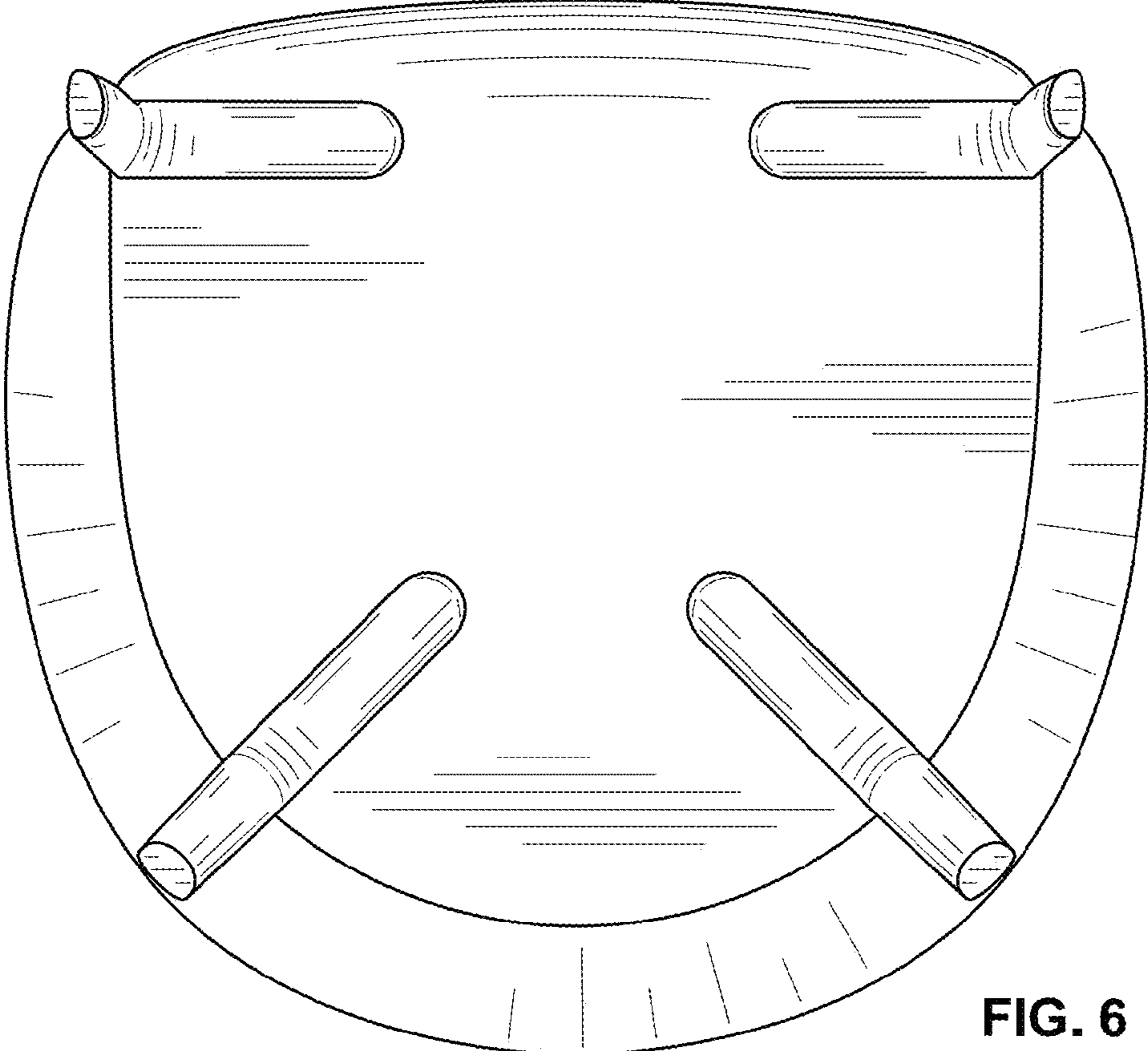

FIG. 6