



US00D895934S

(12) **United States Design Patent** (10) **Patent No.:** **US D895,934 S**  
**Ott** (45) **Date of Patent:** **\*\* Sep. 15, 2020**

(54) **WEARABLE HOLDER FOR ITEMS**

(71) Applicant: **Peter A. Ott**, Brookeville, MD (US)

(72) Inventor: **Peter A. Ott**, Brookeville, MD (US)

(\*\*) Term: **15 Years**

(21) Appl. No.: **29/642,196**

(22) Filed: **Mar. 28, 2018**

(51) **LOC (12) Cl.** ..... **02-02**

(52) **U.S. Cl.**  
USPC ..... **D2/857**

(58) **Field of Classification Search**  
USPC ..... D2/858, 980, 857; D3/218, 226, 215  
See application file for complete search history.

(56) **References Cited**

U.S. PATENT DOCUMENTS

4,029,242	A	6/1977	Stoesser
4,303,239	A	12/1981	Walsh, Jr.
4,579,265	A	4/1986	Schiller
D302,489	S	8/1989	Stone et al.
4,923,105	A	5/1990	Snyder
D313,121	S	12/1990	Dise
4,974,762	A	12/1990	Boretsky et al.
5,020,711	A	6/1991	Kelley
D323,067	S	1/1992	Palma
5,199,621	A	4/1993	McLennan
5,201,448	A	4/1993	Schue
D342,831	S	1/1994	Dise
D348,778	S	6/1994	Dancyger
D348,982	S	7/1994	Dancyger
D348,983	S	7/1994	Dancyger

(Continued)

FOREIGN PATENT DOCUMENTS

WO WO 2004/017784 3/2004

OTHER PUBLICATIONS

Wrist Wallet posted to instructables.com. Available date 2016 based off of review posted "4 years ago," [site visited Mar. 16, 2020 ]. Available: <<https://www.instructables.com/id/Wrist-Wallet-Quick-and-Easy-For-Running/#intro>> (Year: 2016).\*

(Continued)

*Primary Examiner* — Kevin K Rudzinski

(74) *Attorney, Agent, or Firm* — Leveque IP Law, P.C.

(57) **CLAIM**

The ornamental design for a wearable holder for items, as shown and described.

**DESCRIPTION**

FIG. 1 is a front view of a wearable holder for items in an at-rest state;

FIG. 2 is a front view of the wearable holder for items lying substantially flat;

FIG. 3 is a rear view of the wearable holder for items lying substantially flat;

FIG. 4 is a left side view of the wearable holder for items;

FIG. 5 is a right side view of the wearable holder for items;

FIG. 6 is a top view of the wearable holder for items;

FIG. 7 is a bottom view of the wearable holder for items;

FIG. 8 is a front view of the wearable holder for items lying substantially flat with unclaimed items drawn in broken lines placed into the wearable holder for items; and,

FIG. 9 is an in-use view of the wearable holder for items being worn by an unclaimed user drawn in broken lines with unclaimed items drawn in broken lines placed into the wearable holder for items.

The broken lines showing portions of the design are for illustrative purposes only and form no part of the claimed design.

**1 Claim, 7 Drawing Sheets**

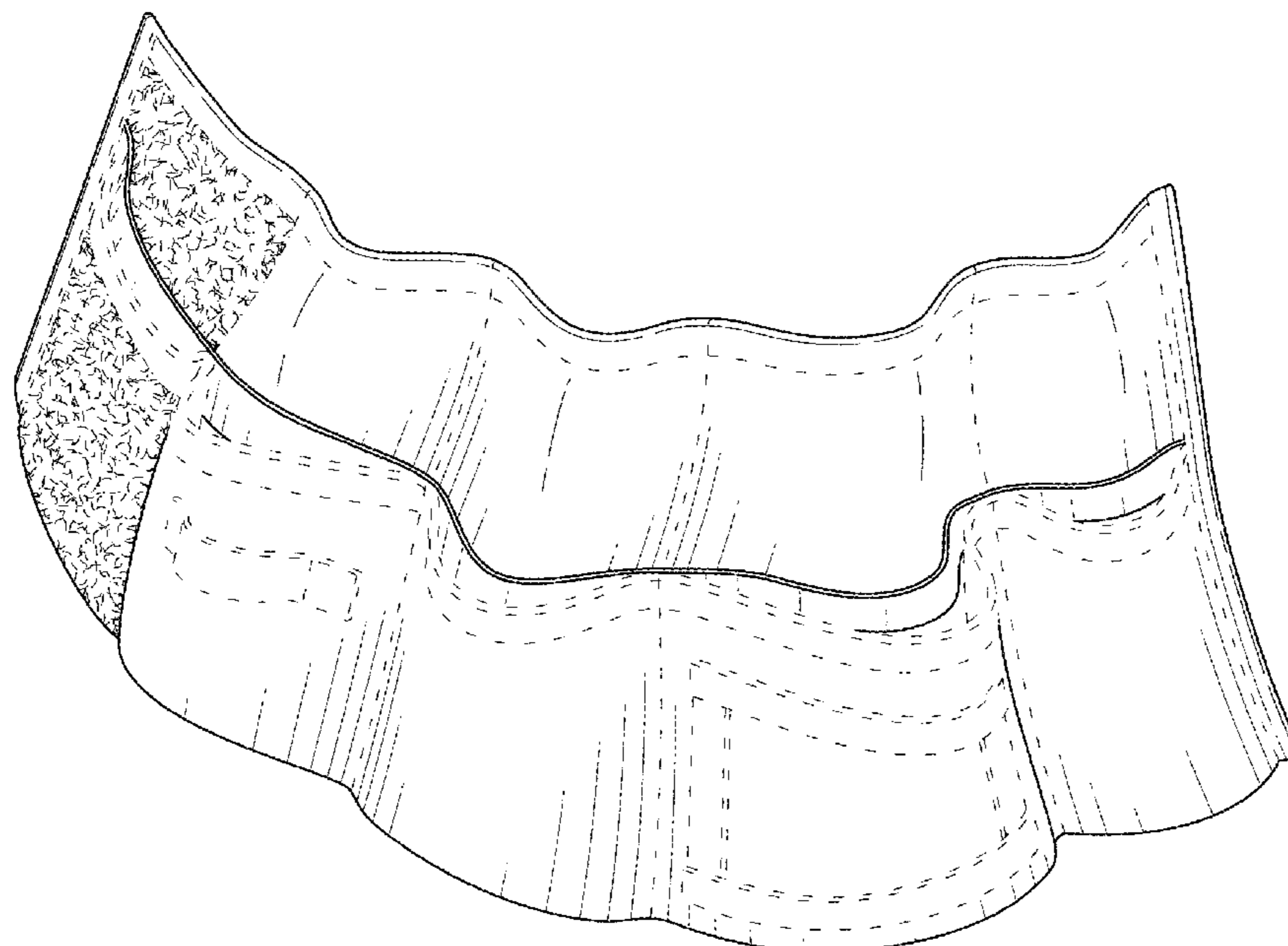

(56)

References Cited

U.S. PATENT DOCUMENTS

D350,849 S 9/1994 Dancyger  
 D352,824 S 11/1994 Saggese, Jr.  
 D359,165 S 6/1995 Kaiser, III  
 5,441,185 A 8/1995 Dragos  
 5,445,303 A 8/1995 Cawile, Jr.  
 D365,677 S \* 1/1996 Dolsey ..... D3/226  
 D371,456 S 7/1996 Champlin et al.  
 5,609,283 A 3/1997 Harrison, Jr.  
 5,651,142 A \* 7/1997 del Valle Mas ..... A41B 11/006  
 2/239  
 6,119,909 A 9/2000 Dancyger  
 D436,243 S 1/2001 Hoy  
 D440,761 S 4/2001 Williams et al.  
 D450,449 S 11/2001 Godshaw et al.  
 6,390,348 B1 5/2002 Godshaw et al.  
 D459,875 S \* 7/2002 Mack ..... D3/226  
 6,446,852 B1 9/2002 Sorensen et al.  
 6,508,391 B2 1/2003 Gilbert  
 D482,196 S 11/2003 Cabrera et al.  
 D485,062 S 1/2004 Hotz  
 6,695,704 B2 2/2004 Parsons  
 6,698,632 B1 3/2004 Turner, Jr. et al.  
 6,712,251 B2 3/2004 Godshaw et al.  
 D501,990 S \* 2/2005 Carr ..... D3/215  
 D507,103 S \* 7/2005 Charles, Jr. .... D3/215  
 D507,106 S 7/2005 Lyle  
 6,913,176 B1 7/2005 Buscemi  
 7,007,832 B1 3/2006 Payne  
 D528,785 S 9/2006 Fraga  
 7,243,824 B2 7/2007 Tabata  
 7,441,278 B2 10/2008 Blakeley  
 D586,553 S 2/2009 Kiss  
 D632,073 S 2/2011 Perez et al.  
 7,996,922 B2 \* 8/2011 Ross ..... A41D 20/00  
 2/170  
 8,196,792 B2 6/2012 Clifton, Jr.  
 D694,518 S 12/2013 Aissa et al.  
 D696,507 S \* 12/2013 Tharp ..... D2/857  
 D696,512 S \* 12/2013 Kryklywicz ..... D3/215  
 D722,764 S \* 2/2015 Sloan ..... D3/218

D745,766 S \* 12/2015 Oppelt ..... D2/627  
 D748,911 S \* 2/2016 Grech ..... D3/218  
 9,289,051 B1 3/2016 Capps  
 D762,372 S \* 8/2016 Jarratt ..... D2/980  
 D771,939 S 11/2016 Kinskey  
 9,846,008 B1 12/2017 DiLeo  
 9,848,688 B2 12/2017 Davis  
 D817,604 S \* 5/2018 Ransmeier ..... D2/858  
 D818,702 S \* 5/2018 Zhuang ..... D3/226  
 D871,052 S \* 12/2019 Overton ..... D2/980  
 2004/0217029 A1 11/2004 Ho  
 2004/0237174 A1 \* 12/2004 Papel ..... A41B 11/006  
 2/239  
 2005/0082323 A1 4/2005 O'Hair  
 2005/0274767 A1 12/2005 Lyle  
 2006/0010578 A1 \* 1/2006 Kane ..... A45F 5/00  
 2/311  
 2006/0102678 A1 5/2006 Bommarito  
 2006/0261107 A1 11/2006 Daniels  
 2007/0006367 A1 1/2007 Newman et al.  
 2007/0295776 A1 12/2007 Whelan  
 2008/0017683 A1 1/2008 Votel  
 2008/0023515 A1 1/2008 Coonan et al.  
 2008/0093406 A1 4/2008 Logan et al.  
 2009/0145789 A1 6/2009 Panosian et al.  
 2010/0152823 A1 6/2010 Muchowicz  
 2013/0008933 A1 1/2013 Clifford  
 2014/0075650 A1 3/2014 Garrison et al.  
 2014/0097216 A1 4/2014 Rogers

OTHER PUBLICATIONS

<https://www.rescue-essentials.com/rescue-essentials-ankle-medical-holster/>, Aug. 10, 2015 first capture Wayback Machine internet archive.  
<https://gear.every-day-ready.com/products/operator-ankle-ifak>, May 28, 2017 first capture (with gear/store) Wayback Machine internet archive.  
<http://www.thewilderness.com/ankle-rigs/ankle-cargo-cuff-ifak/>, May 19, 2017 first capture (with ankle rigs) Wayback Machine internet archive.

\* cited by examiner

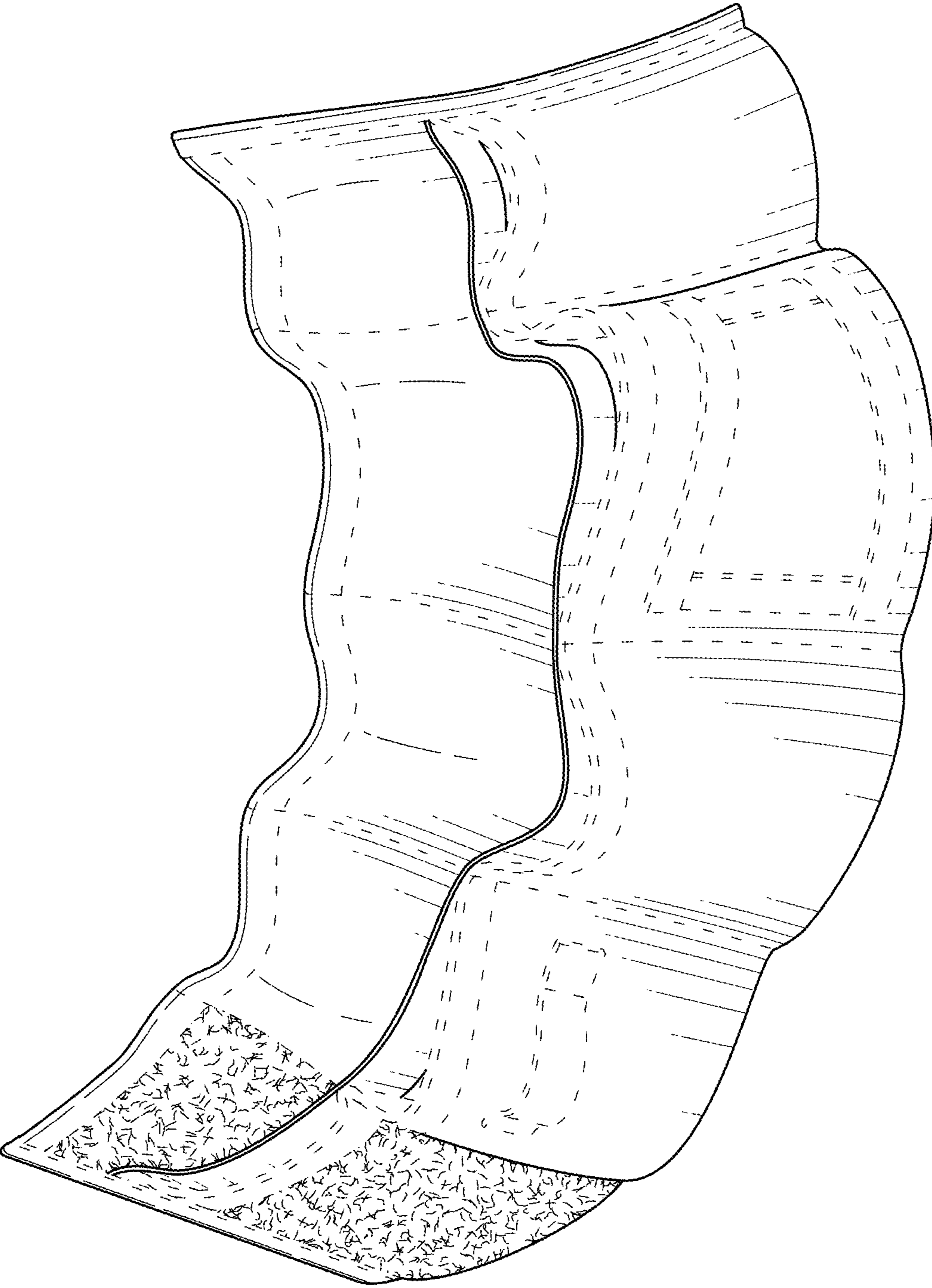

FIG. 1

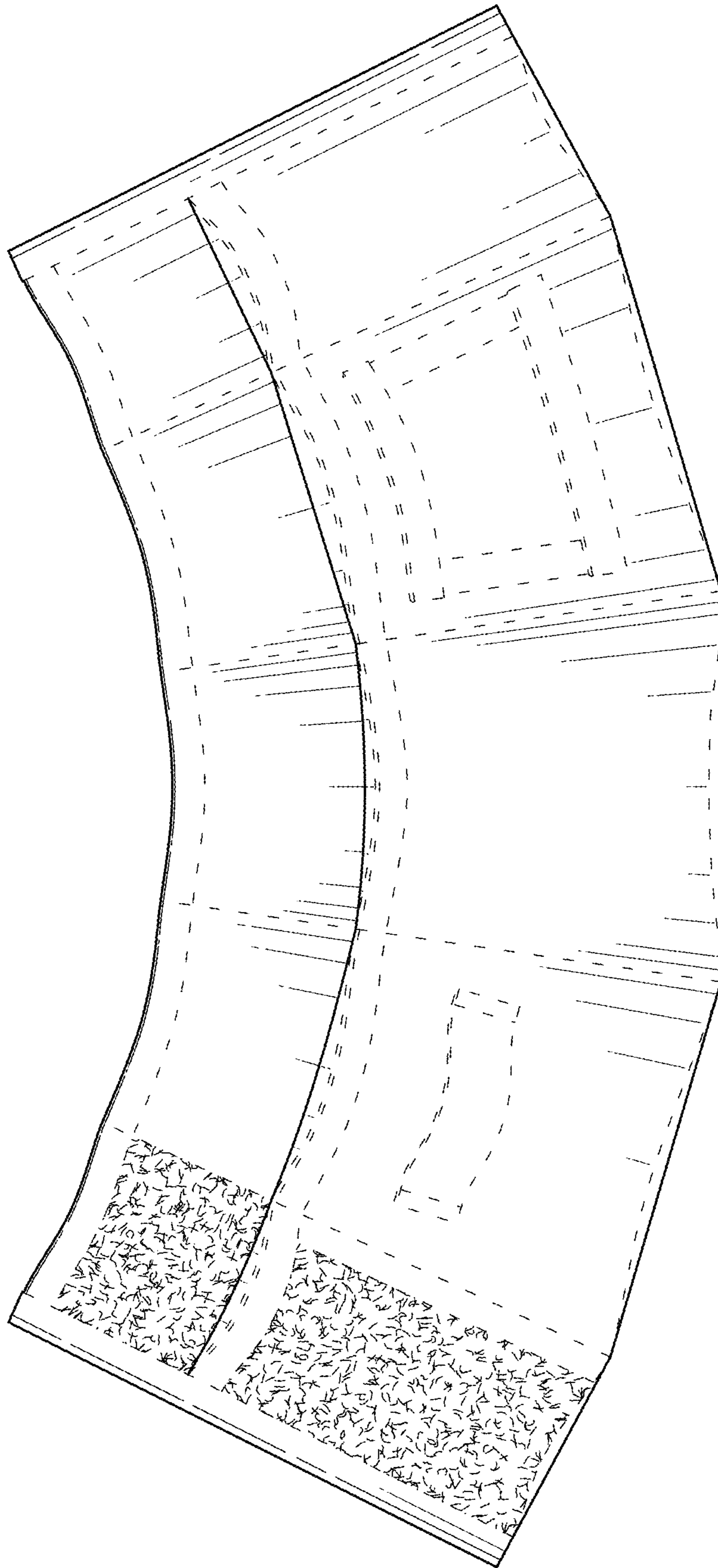

FIG. 2

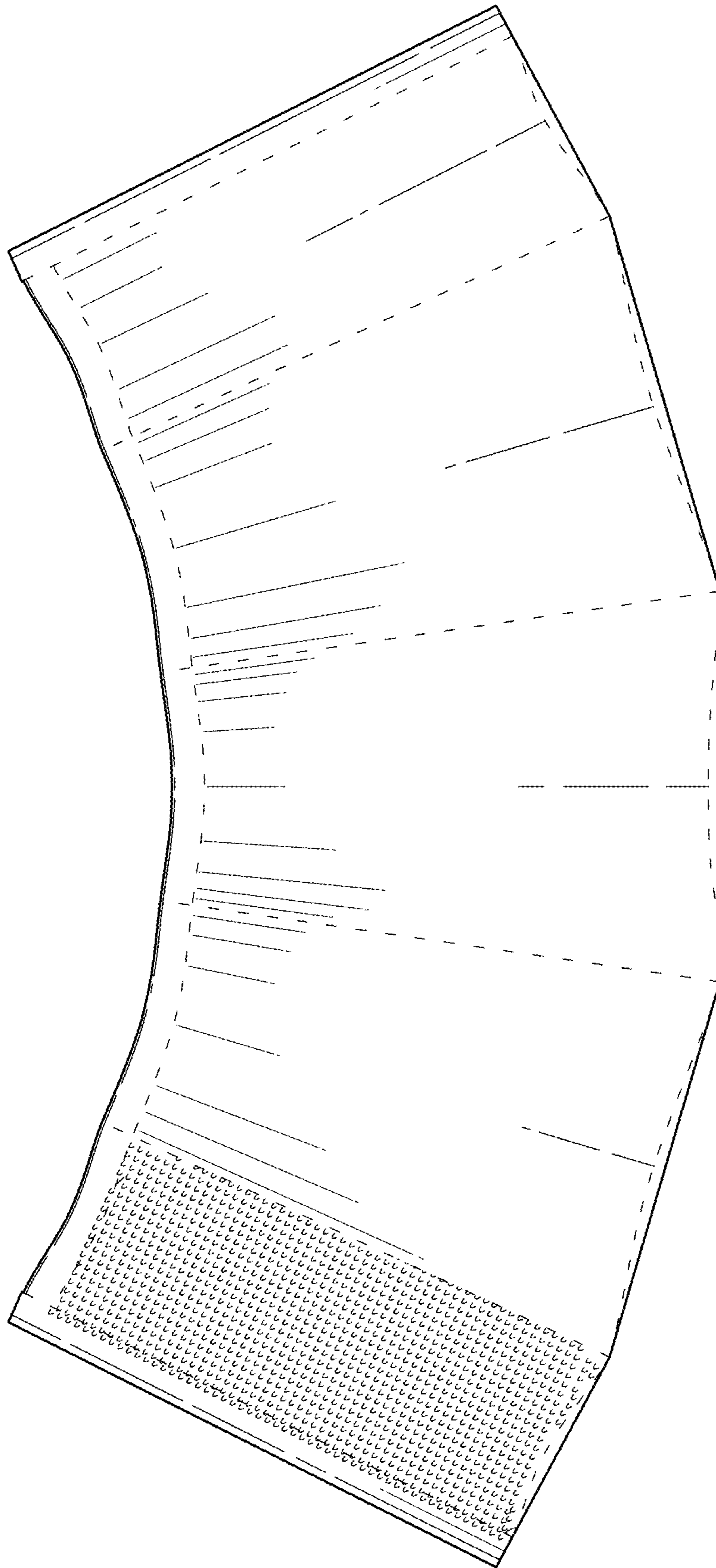

FIG. 3



FIG. 4

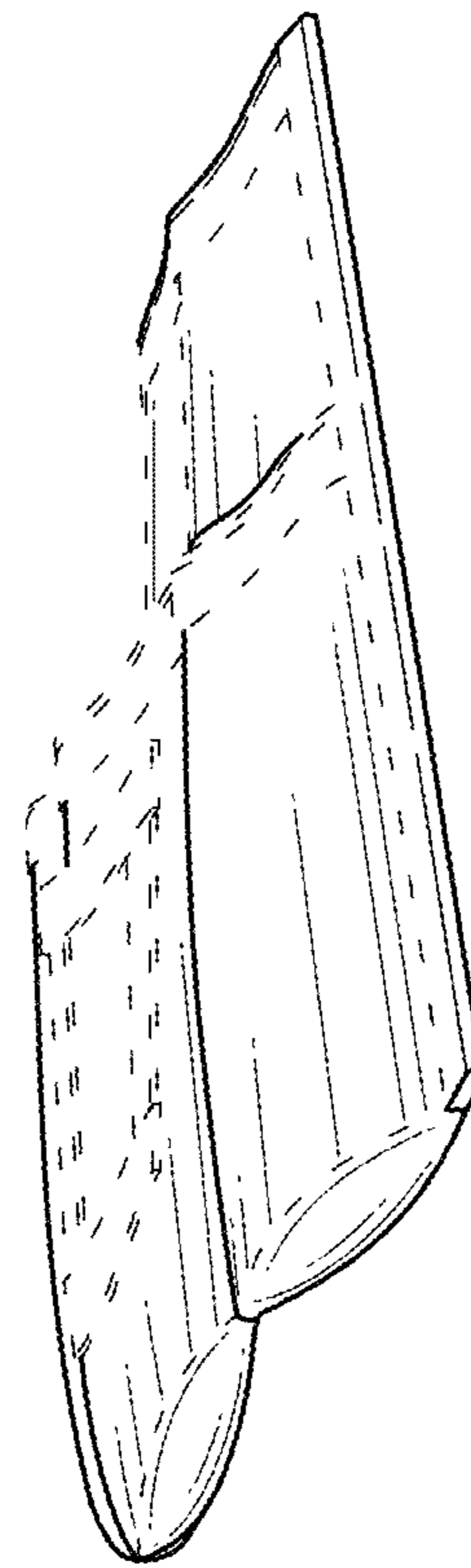

FIG. 5

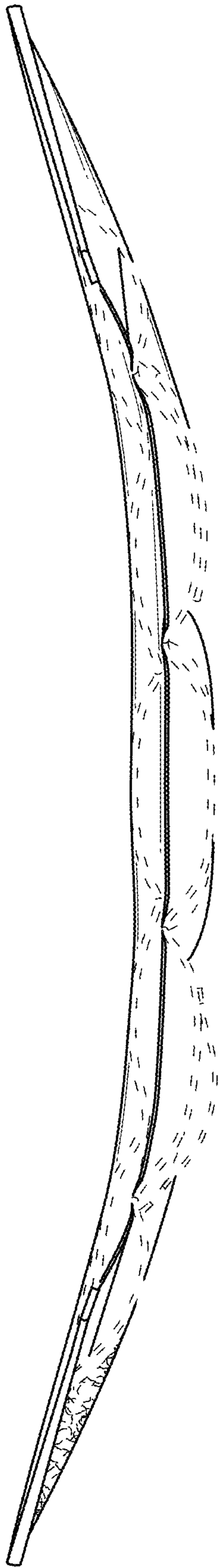

FIG. 6

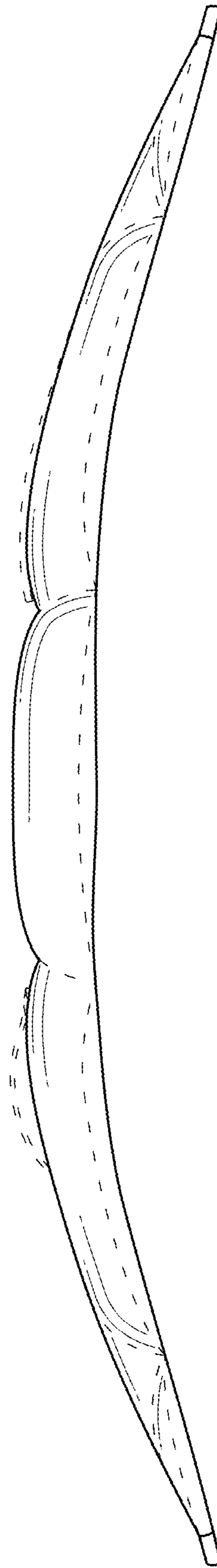

FIG. 7

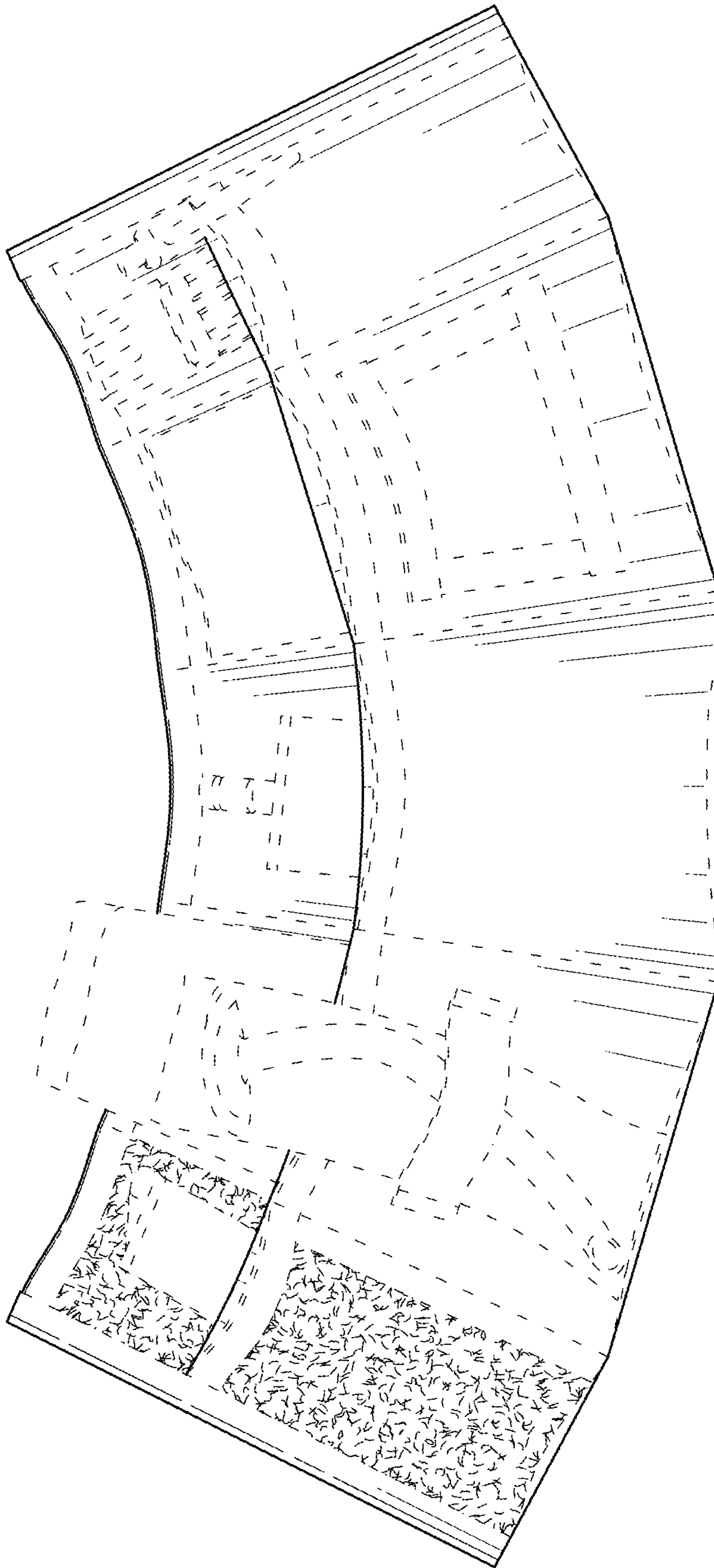

FIG. 8



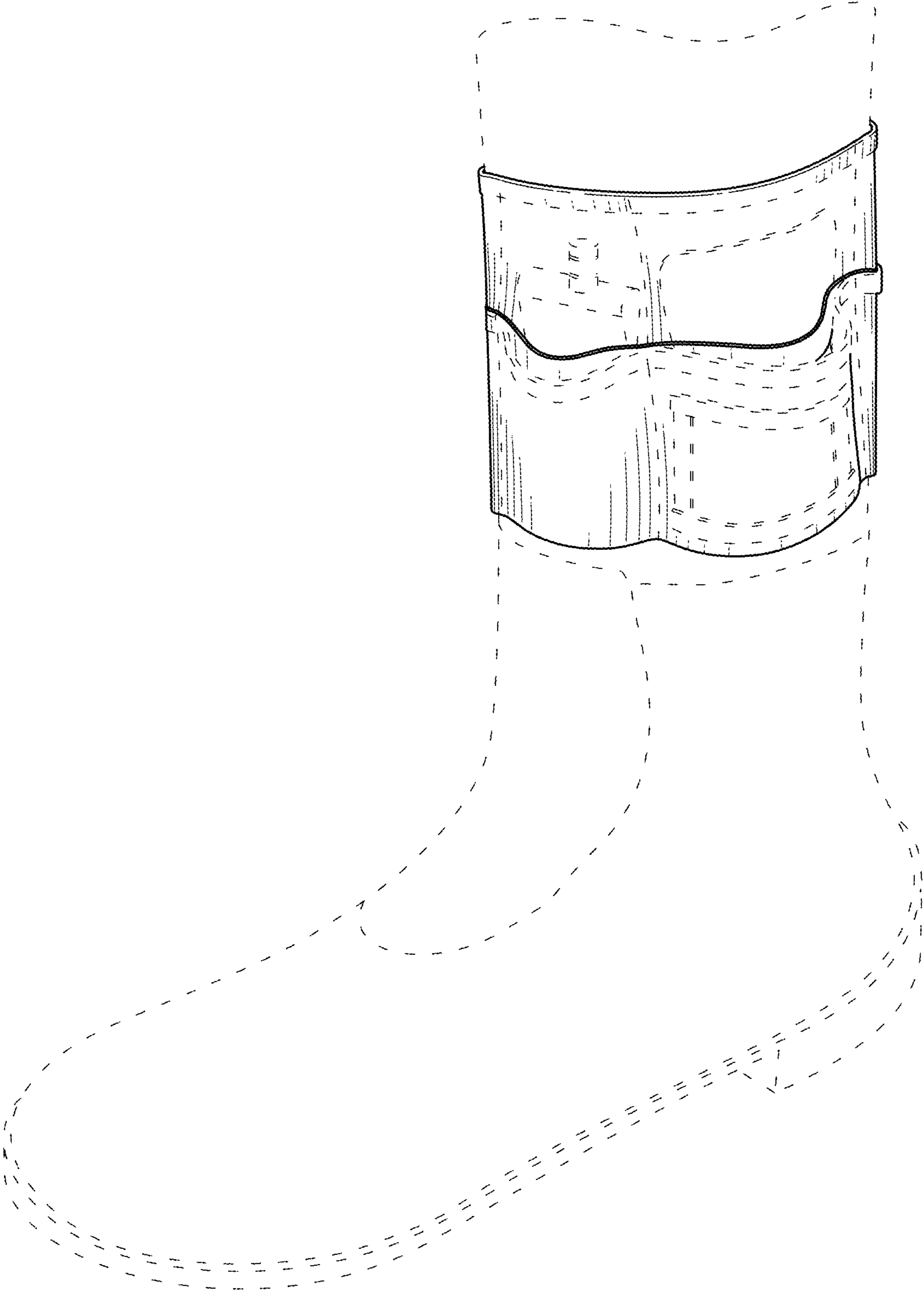

FIG. 9