



US00D895929S

(12) **United States Design Patent**  
**McCombs**

(10) **Patent No.:** **US D895,929 S**  
(45) **Date of Patent:** **\*\* \*Sep. 15, 2020**

- (54) **SPLIT GROIN UNDERGARMENT**
- (71) Applicant: **Kelly McCombs**, Seattle, WA (US)
- (72) Inventor: **Kelly McCombs**, Seattle, WA (US)
- (73) Assignee: **Elira Apparel, LLC**, Seattle, WA (US)
- (\*) Notice: This patent is subject to a terminal disclaimer.
- (\*\*) Term: **15 Years**
- (21) Appl. No.: **29/583,503**
- (22) Filed: **Nov. 6, 2016**

3,040,751 A 6/1962 Mastenbrook  
 3,637,230 A \* 1/1972 Poik ..... A41D 1/08  
 280/845  
 3,813,697 A \* 6/1974 Belpaume ..... A41D 1/06  
 2/227

(Continued)

**OTHER PUBLICATIONS**

“3 Reasons ‘Open-Crotch Underwear’ Just Doesn’t Make Sense” [online]. Jenny Isenman. [Published on Nov. 15, 2012]. Retrieved from the Internet: <[https://thestir.cafemom.com/love/146415/3\\_reasons\\_opencrotch\\_underwear\\_just](https://thestir.cafemom.com/love/146415/3_reasons_opencrotch_underwear_just)>.\*

(Continued)

*Primary Examiner* — Khawaja Anwar  
*Assistant Examiner* — Mojtaba Tehrani  
 (74) *Attorney, Agent, or Firm* — Han Santos, PLLC

**Related U.S. Application Data**

- (63) Continuation-in-part of application No. 29/517,816, filed on Feb. 17, 2015, now Pat. No. Des. 774,727, and a continuation-in-part of application No. 14/623,294, filed on Feb. 16, 2015, now abandoned, and a continuation-in-part of application No. 29/515,607, filed on Jan. 23, 2015, now Pat. No. Des. 775,453.
- (51) **LOC (12) Cl.** ..... **02-02**
- (52) **U.S. Cl.**  
USPC ..... **D2/712**
- (58) **Field of Classification Search**  
USPC ..... D2/712, 713, 714, 715, 716, 731, 732, D2/736, 737, 738  
CPC ..... A41D 1/089; B29L 2031/4871; B29L 2031/5254; D10B 2501/02  
See application file for complete search history.

(56) **References Cited**

**U.S. PATENT DOCUMENTS**

2,190,425 A \* 2/1940 Hurd ..... A41B 9/02  
 2/401  
 2,323,451 A 7/1943 Conrad

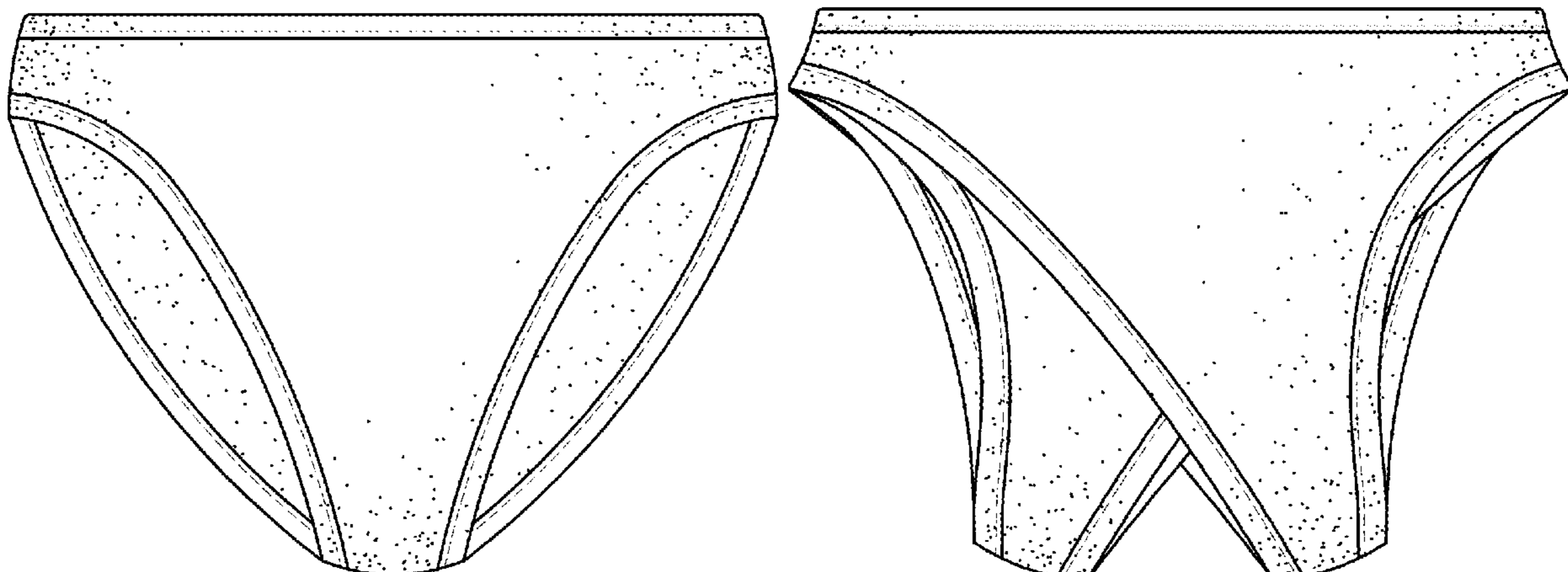
(57) **CLAIM**

The ornamental design for a split groin undergarment, as shown and described.

**DESCRIPTION**

FIG. 1 is an isometric view of a split groin undergarment in the closed configuration;  
 FIG. 2 is front view thereof;  
 FIG. 3 is a rear view thereof;  
 FIG. 4 is a right side view thereof;  
 FIG. 5 is a left side view thereof;  
 FIG. 6 is a top view thereof;  
 FIG. 7 is a bottom view thereof;  
 FIG. 8 is an isometric view of a split groin undergarment in the open configuration;  
 FIG. 9 is front view thereof;  
 FIG. 10 is a rear view thereof;  
 FIG. 11 is a right side view thereof;  
 FIG. 12 is a left side view thereof;  
 FIG. 13 is a top view thereof; and,  
 FIG. 14 is a bottom view thereof.

(Continued)



Dashed lines in the figure drawings represent stitching and form no part of the claimed design.

**1 Claim, 8 Drawing Sheets**

(56)

**References Cited**

U.S. PATENT DOCUMENTS

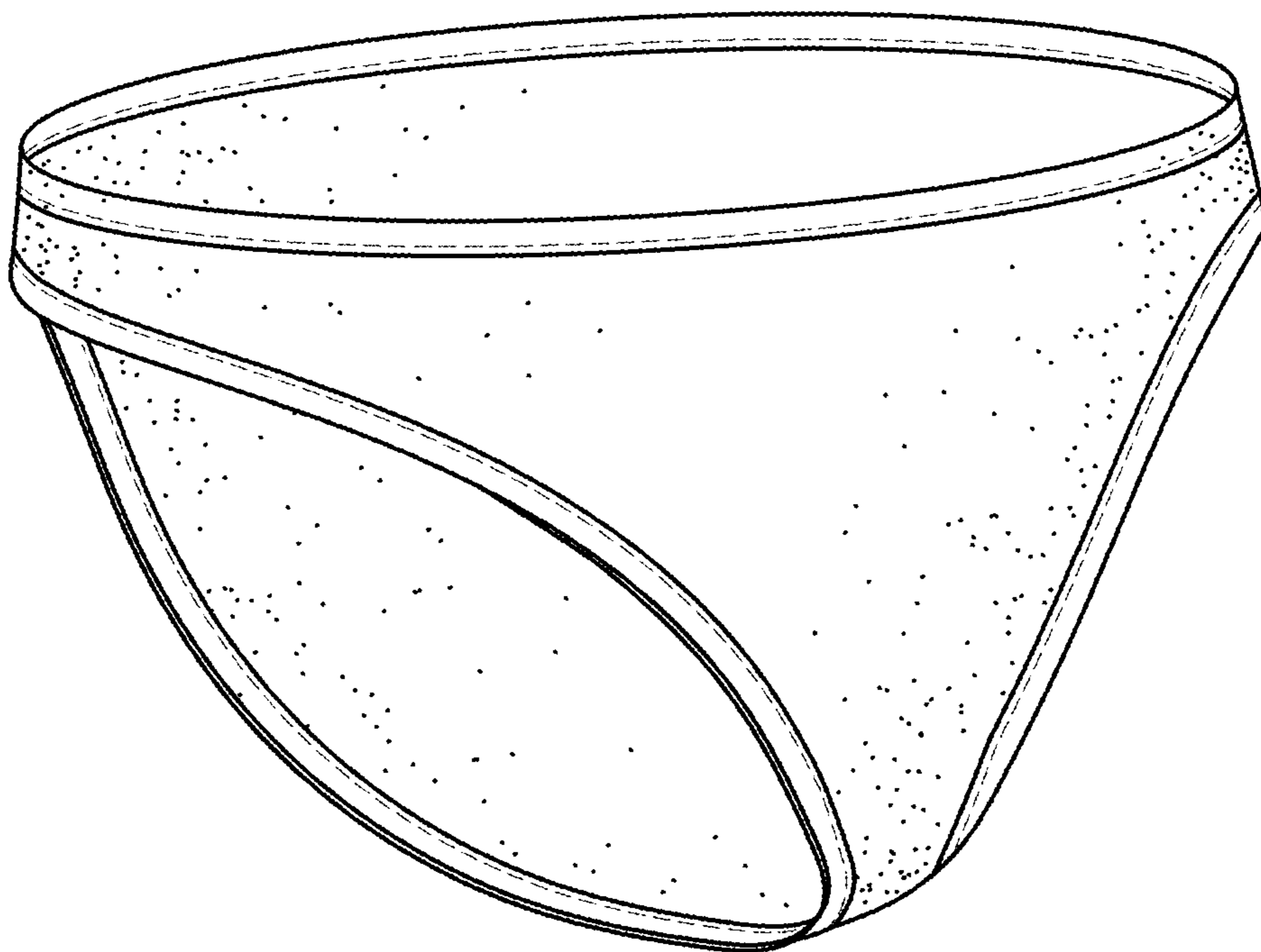
5,182,815 A \* 2/1993 Young ..... A41B 9/004  
2/406  
5,535,757 A \* 7/1996 Fleming, Jr. .... A61F 6/04  
128/842  
D384,487 S \* 10/1997 Ingels ..... D2/713  
6,018,822 A \* 2/2000 Hernandez ..... A41B 9/02  
2/405  
D487,182 S \* 3/2004 Wilson-Robinson ..... D2/712  
D506,303 S \* 6/2005 Rocha ..... 2/69  
7,087,032 B1 8/2006 Ikeda  
D584,880 S \* 1/2009 Ingrassia ..... D2/712  
D663,507 S \* 7/2012 Nguyen ..... D2/738  
D667,198 S \* 9/2012 Calabria ..... D2/712  
D667,609 S \* 9/2012 Zorin ..... D2/713  
D687,617 S 8/2013 LaCour-Phillippi  
D702,917 S \* 4/2014 White ..... D2/712  
D722,420 S 2/2015 Abrams  
D722,742 S 2/2015 Abrams  
D733,396 S \* 7/2015 Waters ..... D2/716  
D733,997 S \* 7/2015 Brown ..... D2/731  
D746,544 S 1/2016 Curran  
D746,545 S 1/2016 Kositchiranant  
D753,893 S \* 4/2016 Yang ..... D2/712  
D768,958 S \* 10/2016 Dickson ..... D2/712  
D774,727 S \* 12/2016 McCombs ..... D2/712

D775,453 S \* 1/2017 McCombs ..... D2/712  
D786,535 S \* 5/2017 Grosse ..... D2/738  
D806,982 S \* 1/2018 Grace ..... D2/700  
D811,041 S \* 2/2018 Bethke, Jr. .... D2/712  
D811,694 S \* 3/2018 Griffin ..... D2/742  
D831,304 S \* 10/2018 Miller ..... D2/731  
D848,113 S \* 5/2019 Flockton ..... D2/731  
D858,940 S \* 9/2019 Rodriguez ..... D2/711  
2005/0115568 A1\* 6/2005 Martin ..... A61F 6/065  
128/844  
2007/0032771 A1\* 2/2007 Abed ..... A41B 9/001  
604/385.22  
2014/0053322 A1\* 2/2014 Zamler ..... A41B 9/04  
2/407  
2014/0182048 A1\* 7/2014 Gregory ..... A41B 9/005  
2/400  
2015/0157058 A1\* 6/2015 McCombs ..... A41B 9/005  
2/400

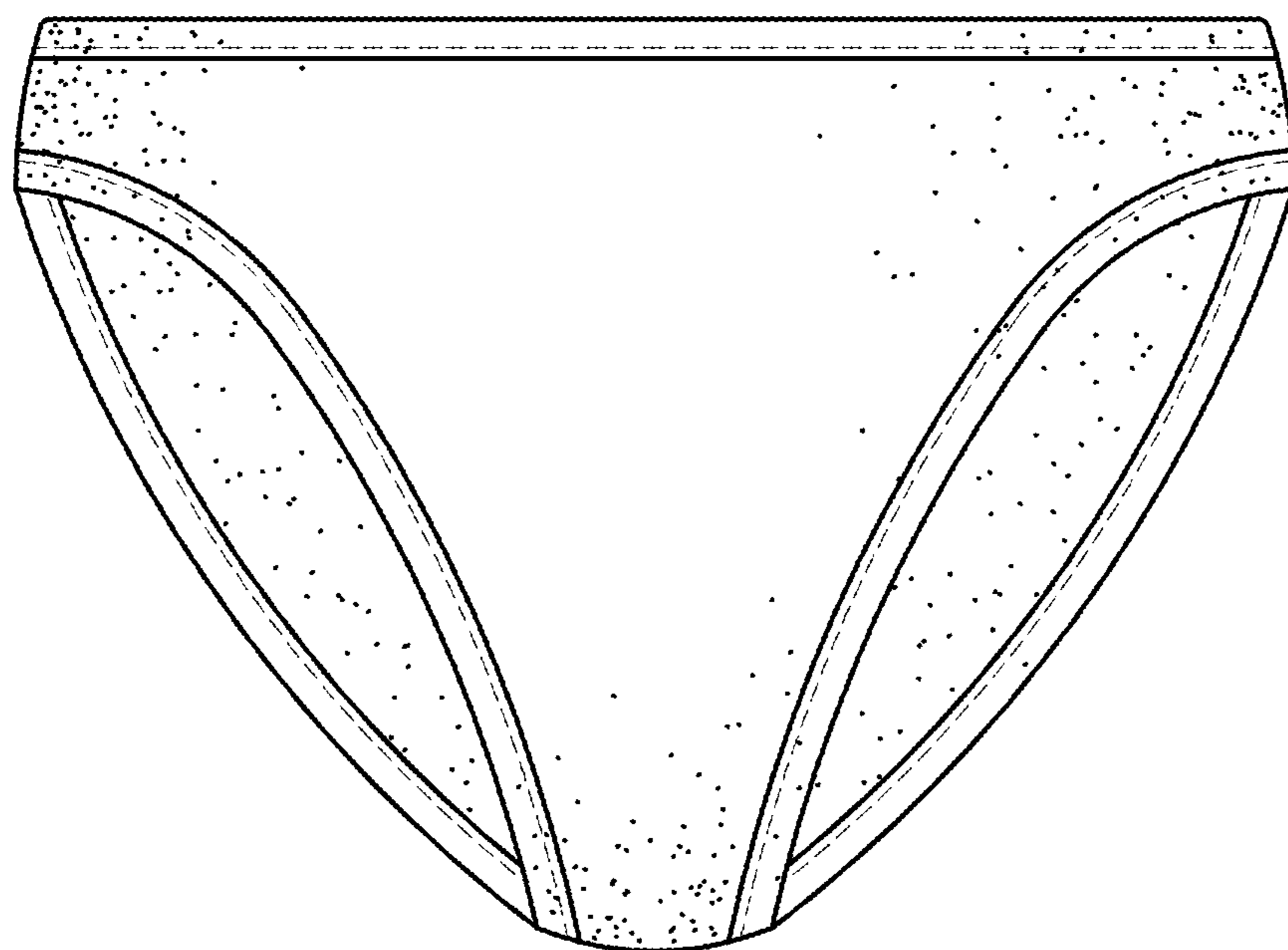
OTHER PUBLICATIONS

<http://www.ergowear.com/gym-compression-shorts-red>—  
downloaded Feb. 10, 2016.  
<http://www.run247.com/article-5137-breakthrough-compression-shorts-to-help-prevent-and-aid-management-of-common-sports-injury/html>—Published Jun. 13, 2014.  
Design U.S. Appl. No. 29/515,607, Non Final Office Action dated Feb. 25, 2016, 14 pages.  
Design U.S. Appl. No. 29/517,816, Non Final Office Action dated Feb. 25, 2016, 10 pages.  
U.S. Appl. No. 14/623,294, Non Final Office Action dated Dec. 1, 2015, 14 pages.  
U.S. Appl. No. 14/623,294, Non Final Office Action dated Feb. 1, 2017, 13 pages.

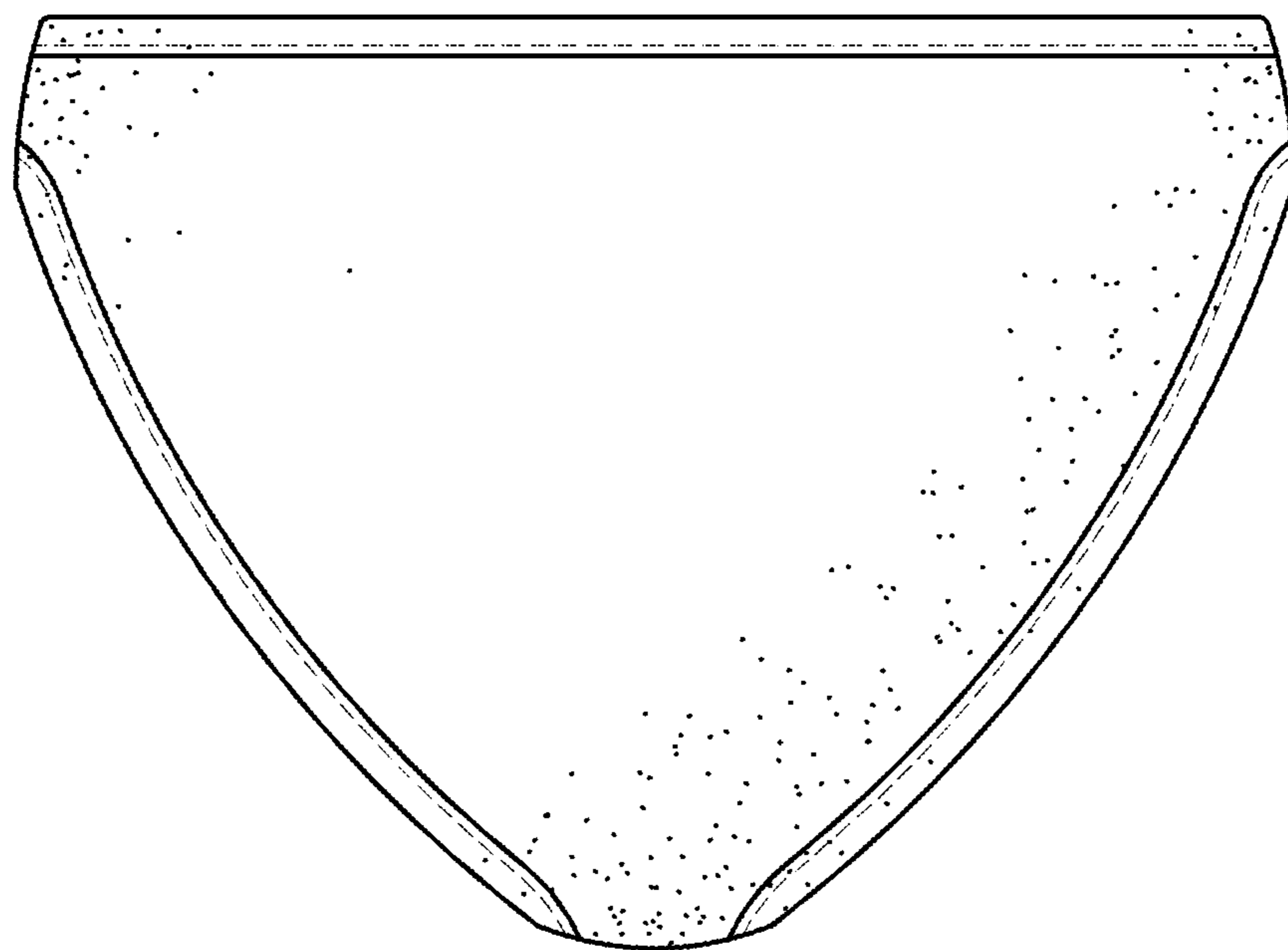
\* cited by examiner



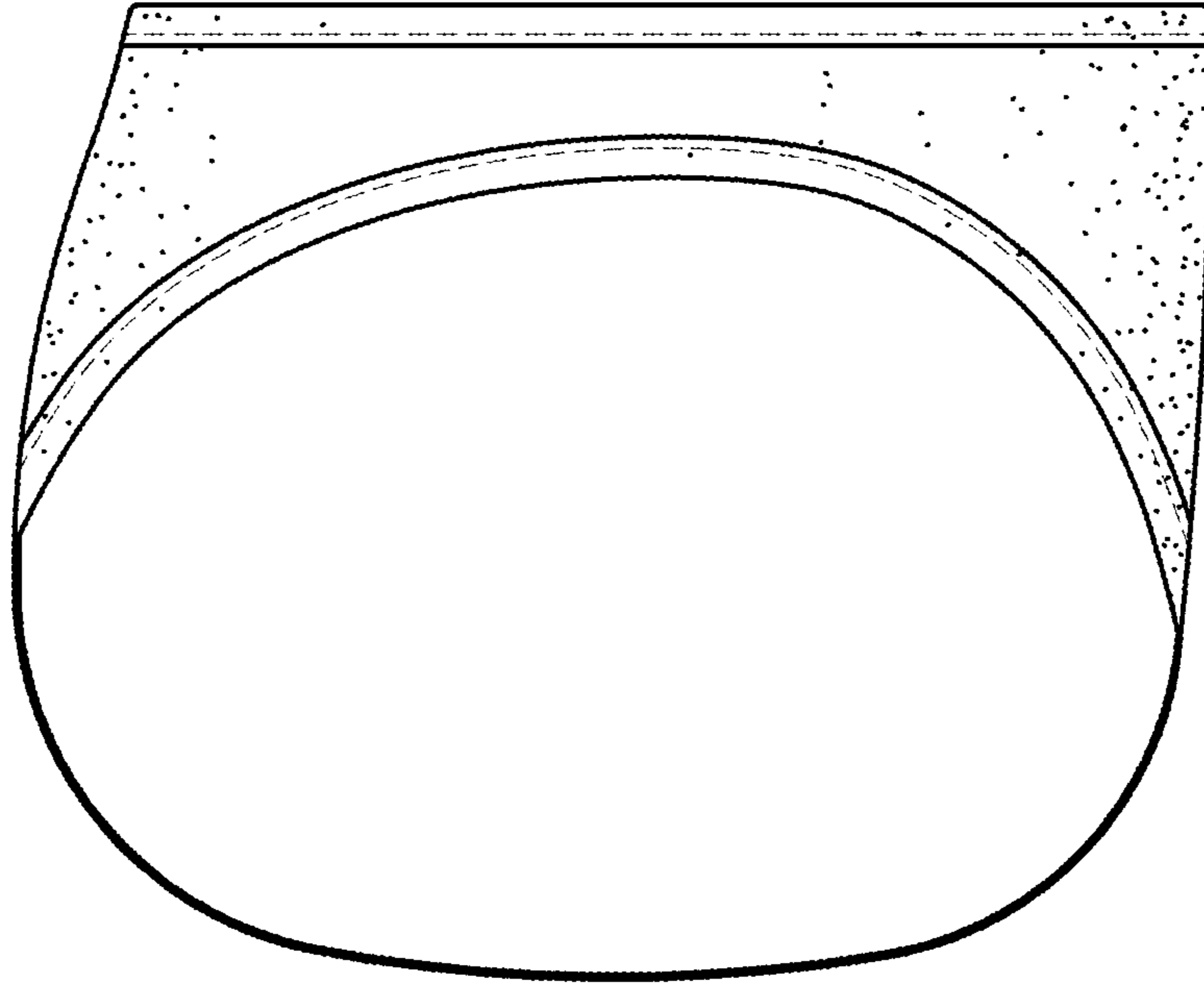
**FIG. 1**



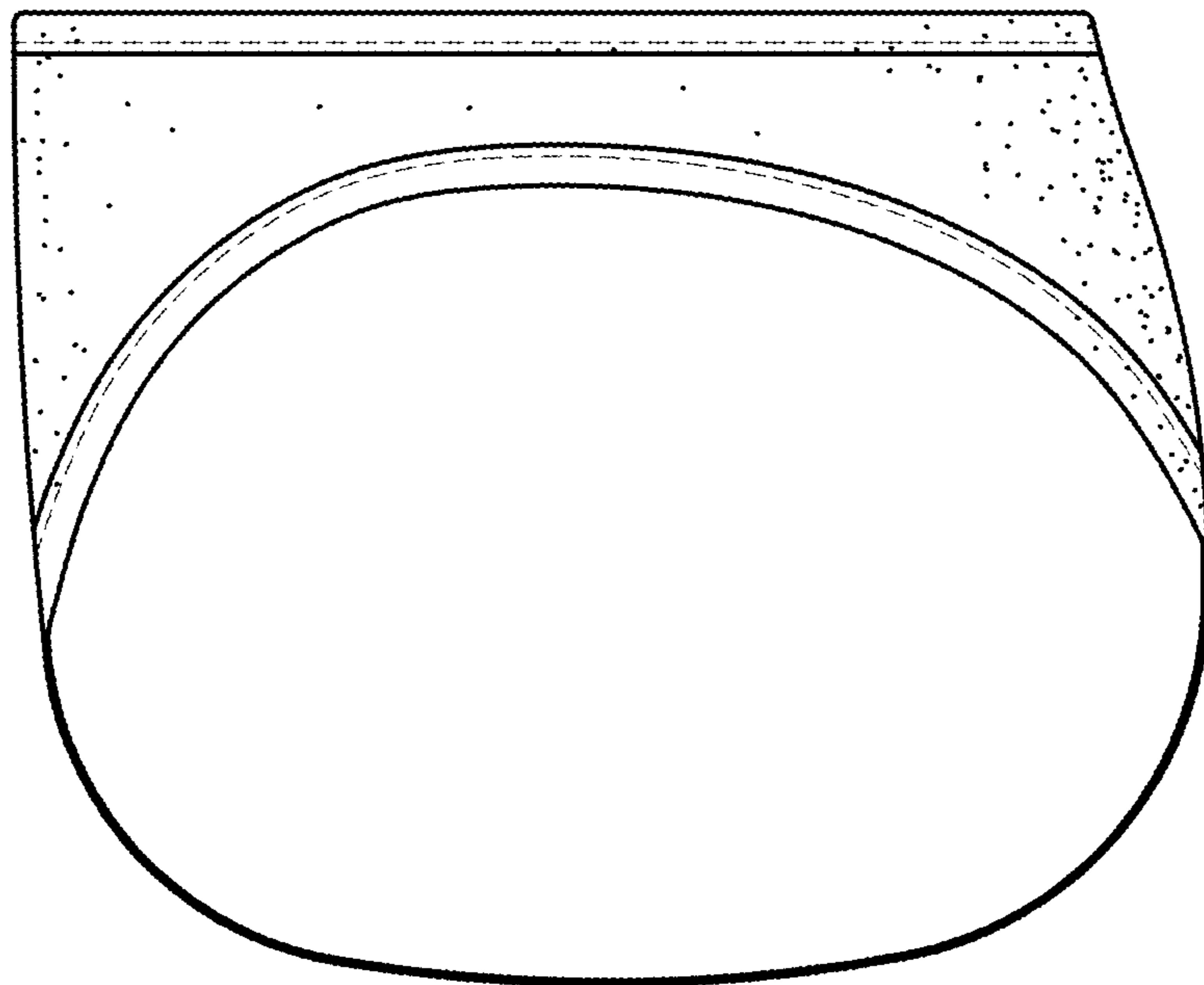
**FIG. 2**



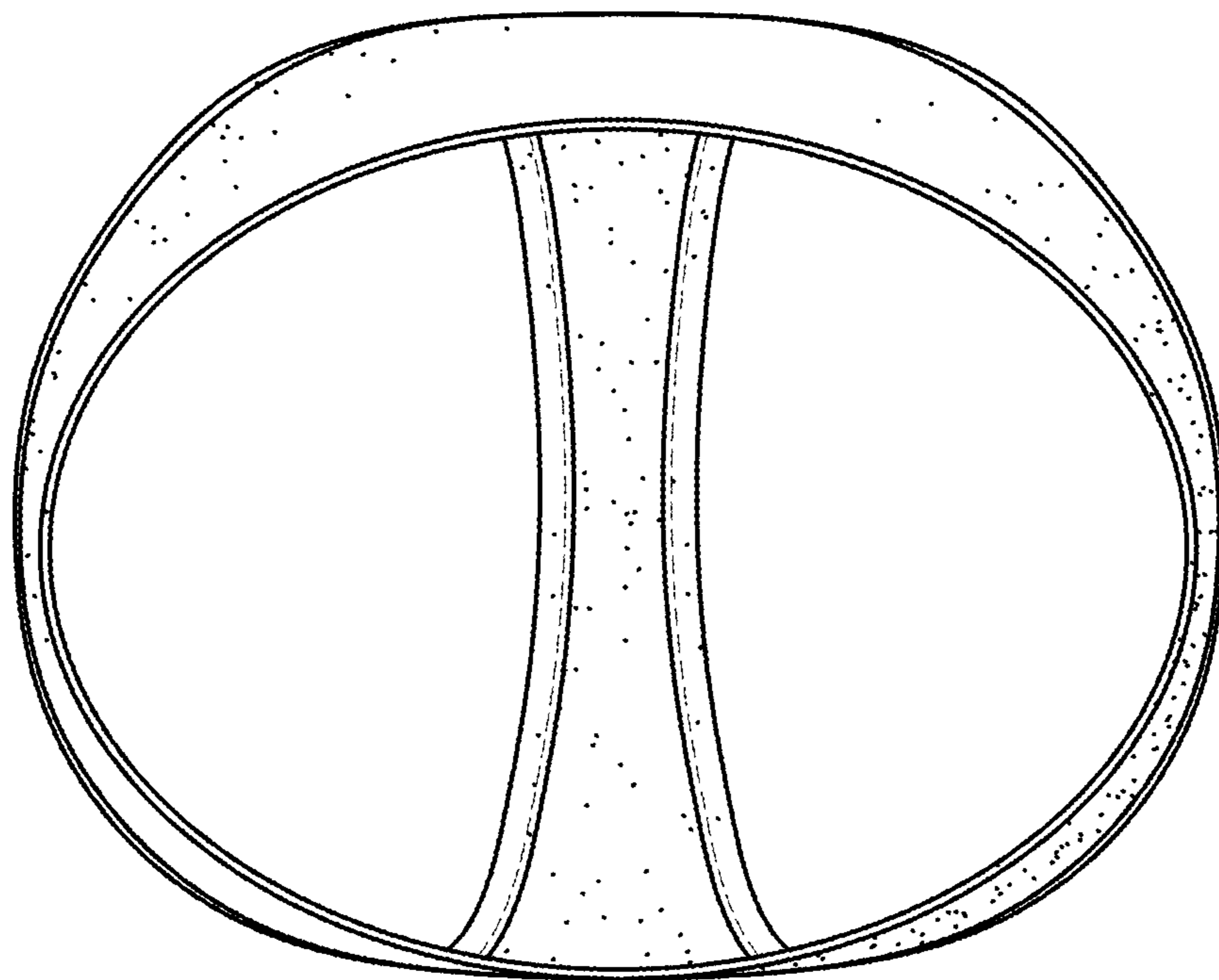
**FIG. 3**



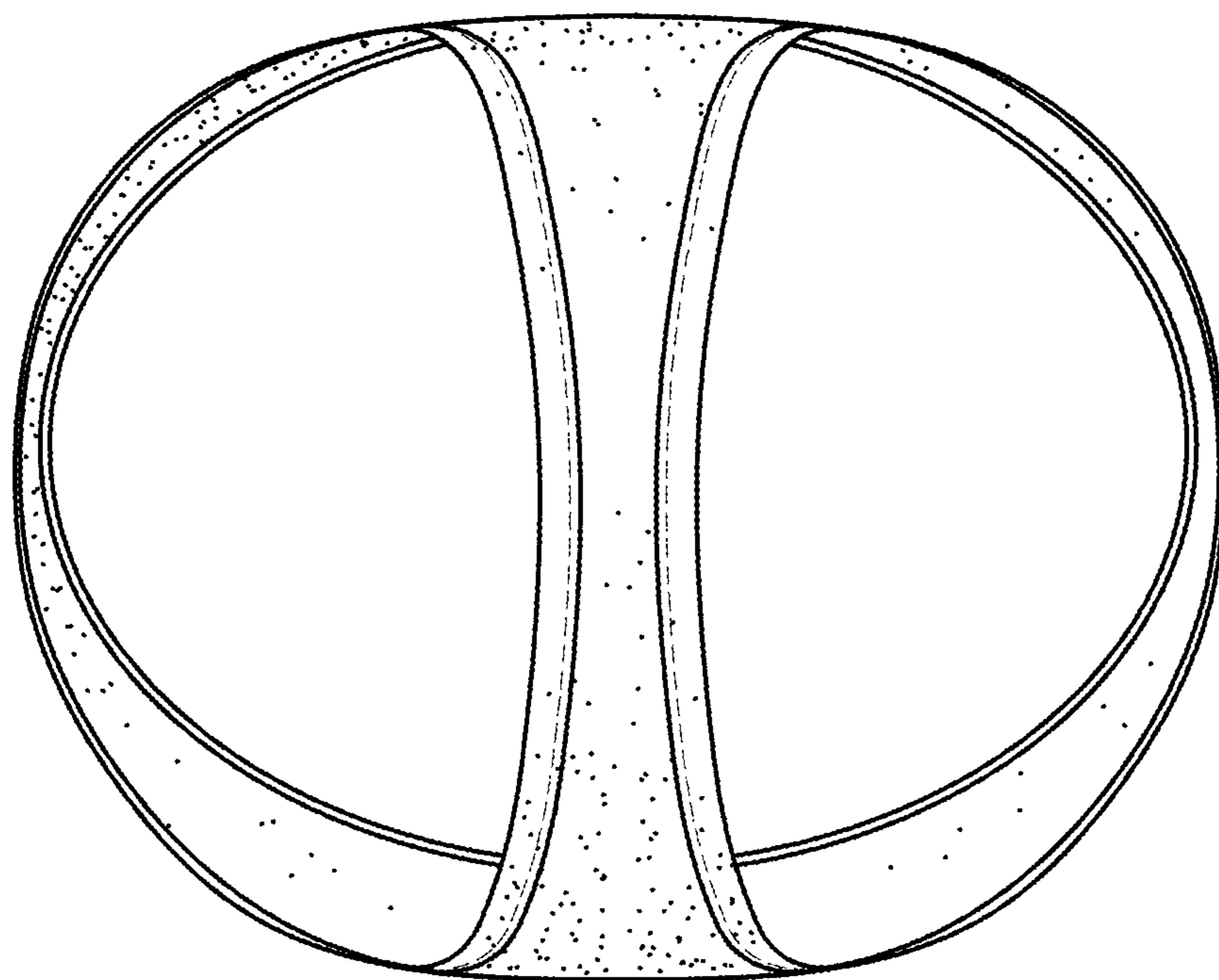
*FIG. 4*



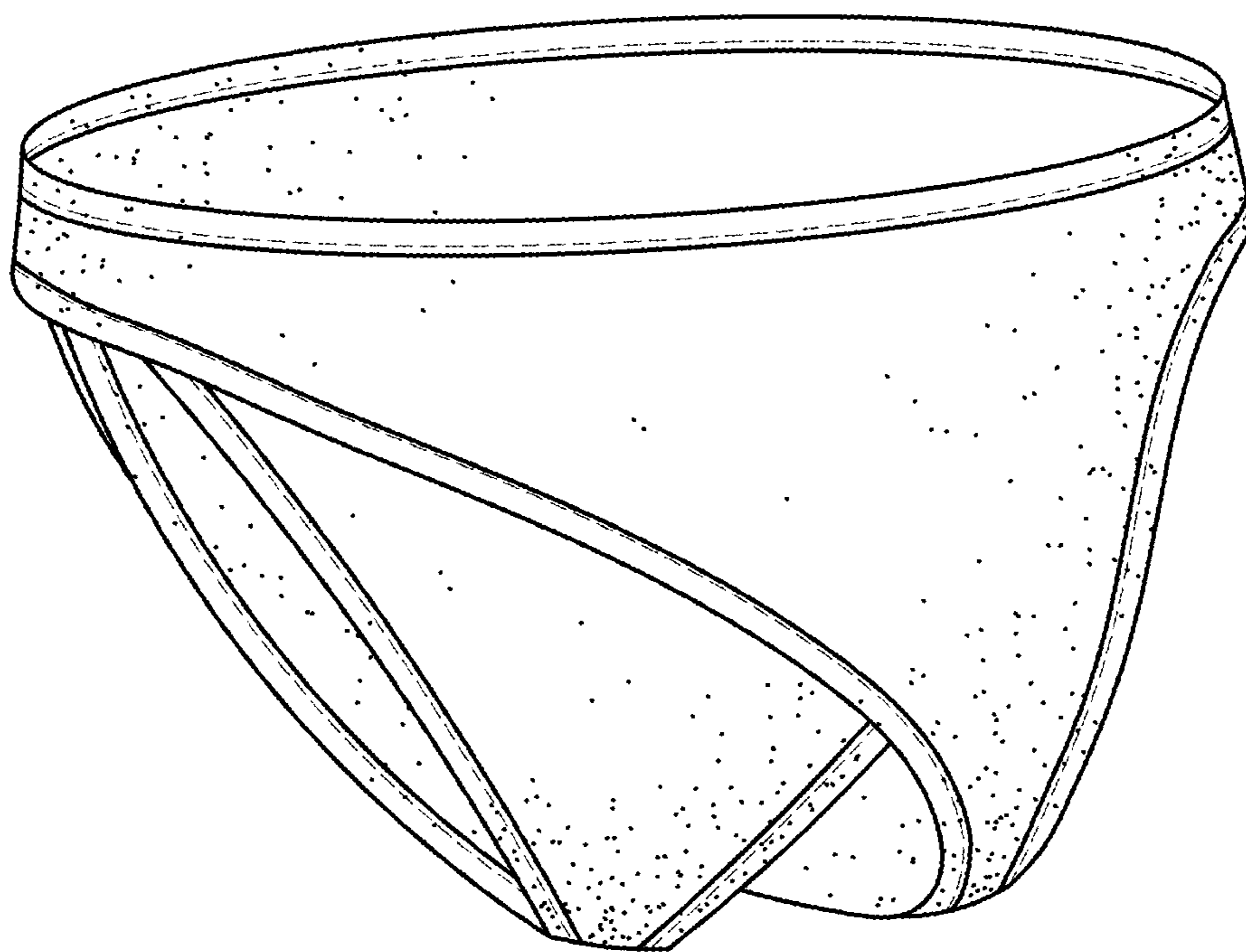
*FIG. 5*



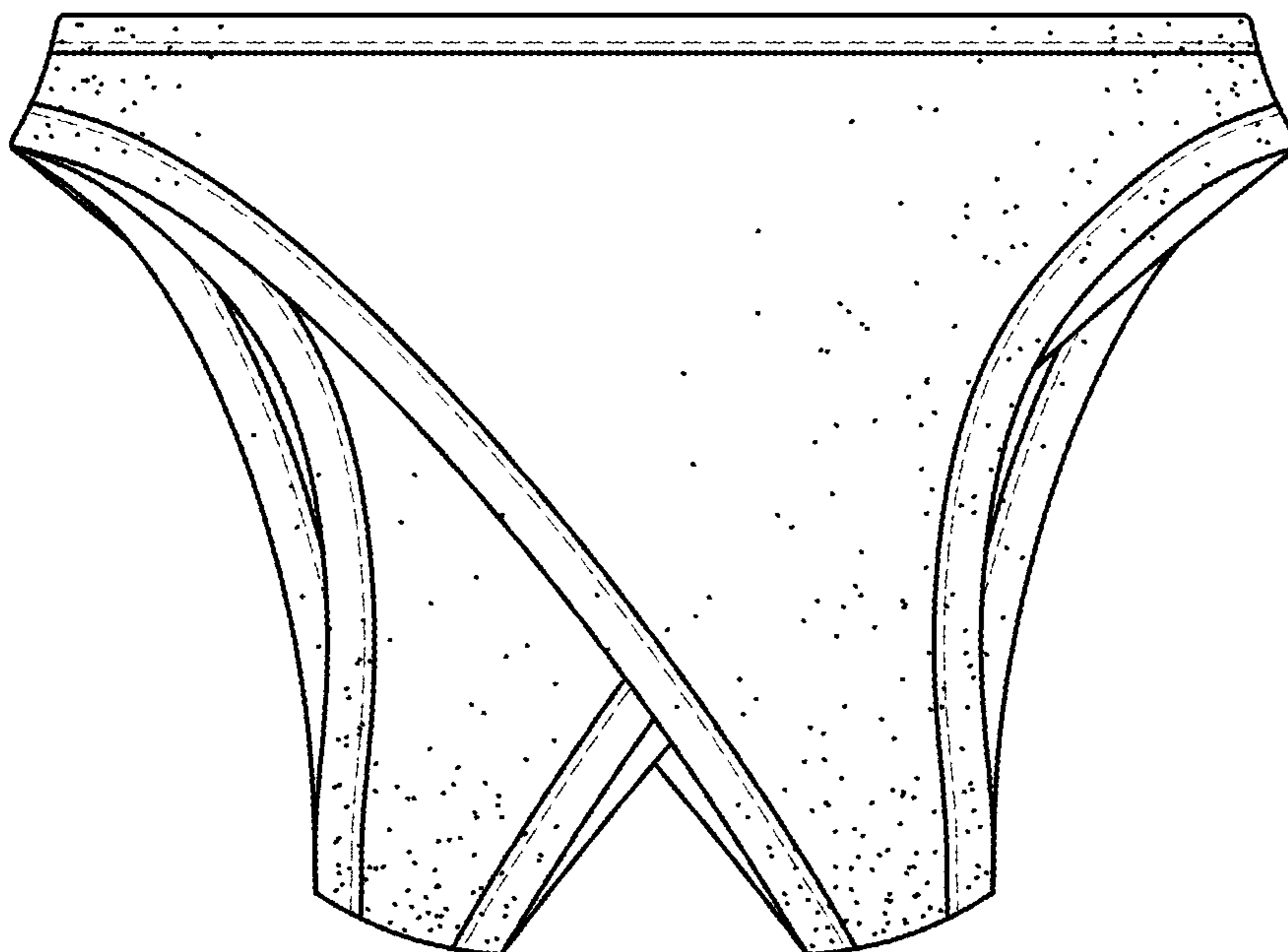
**FIG. 6**



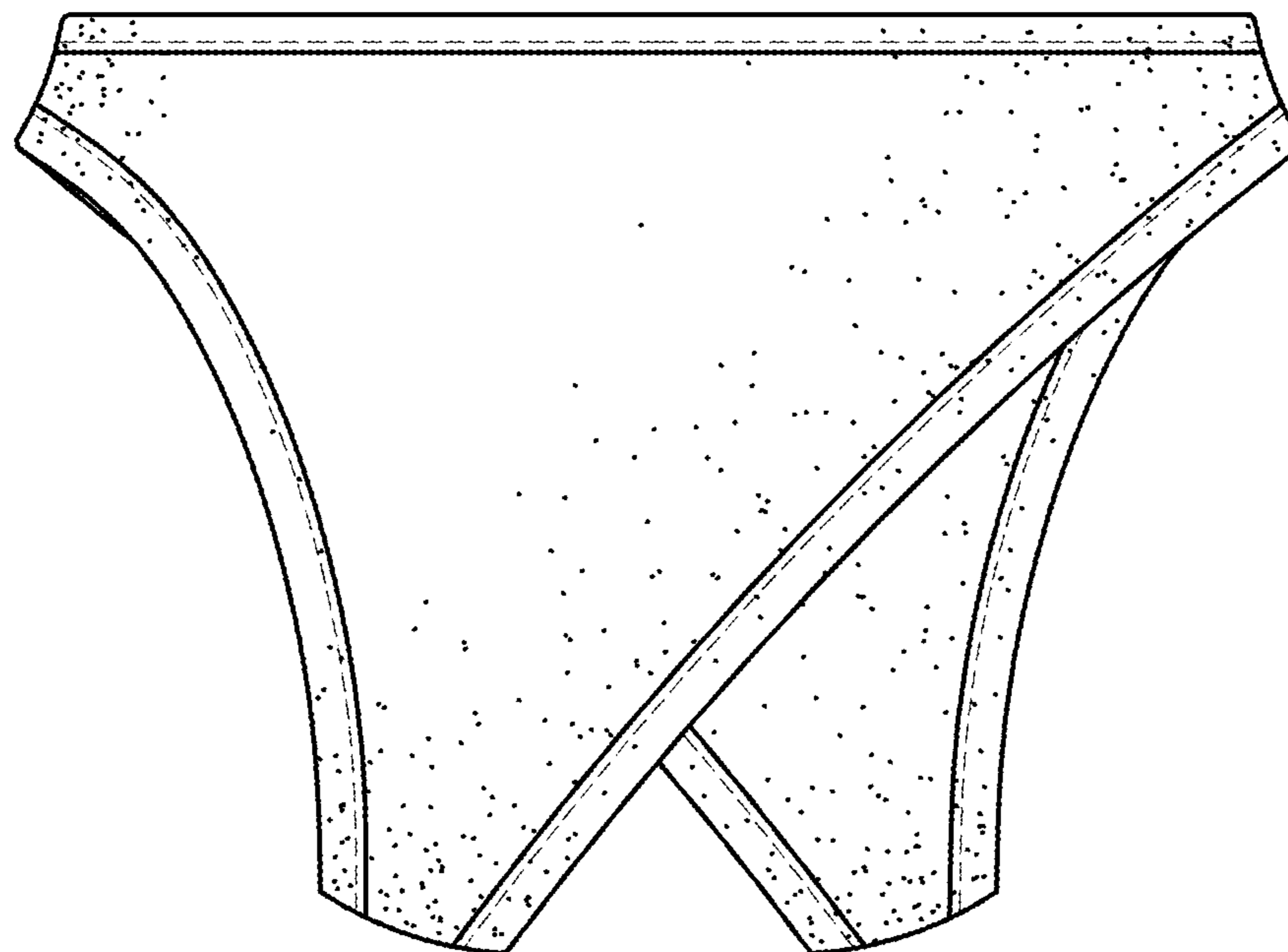
**FIG. 7**



**FIG. 8**

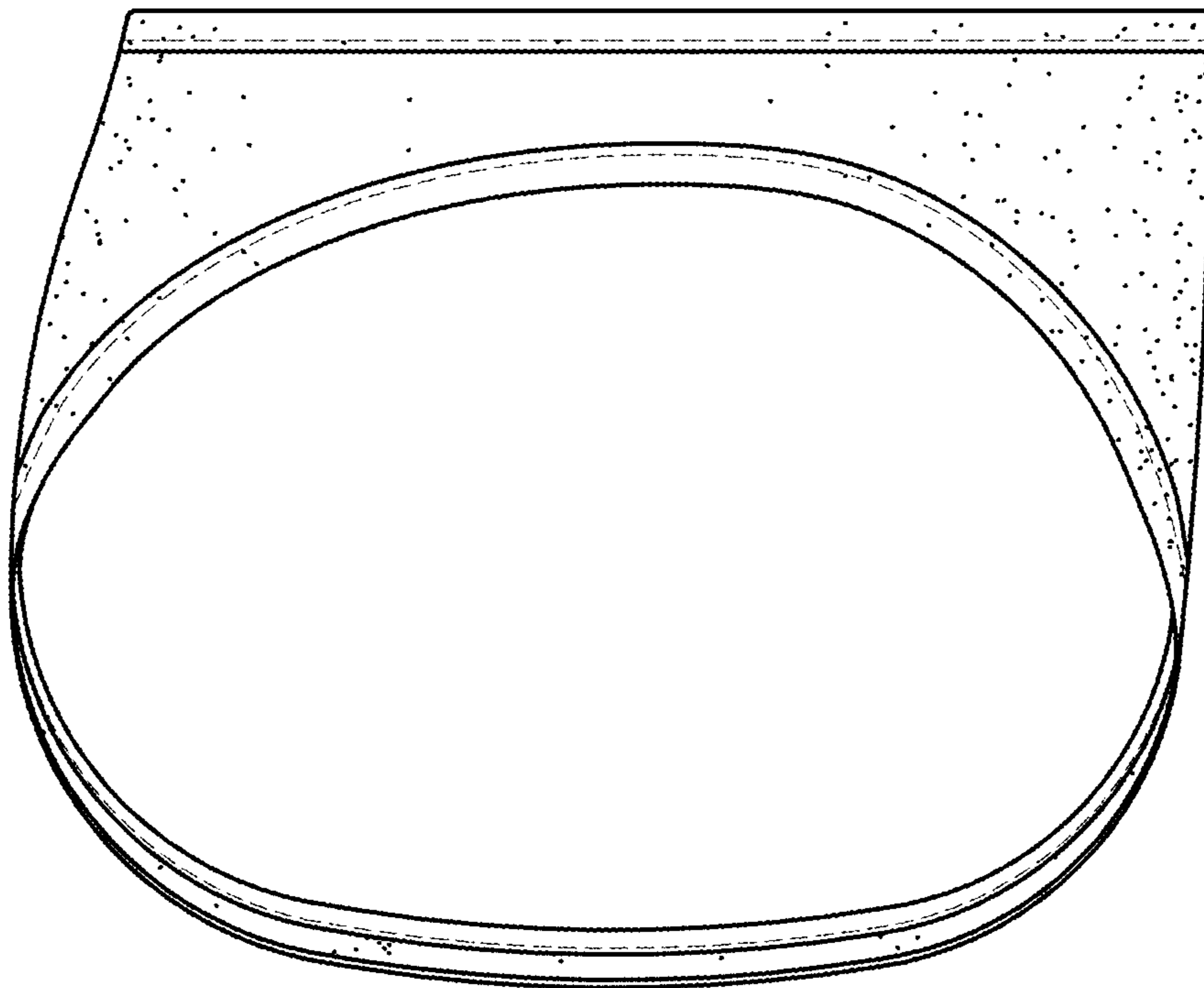


**FIG. 9**

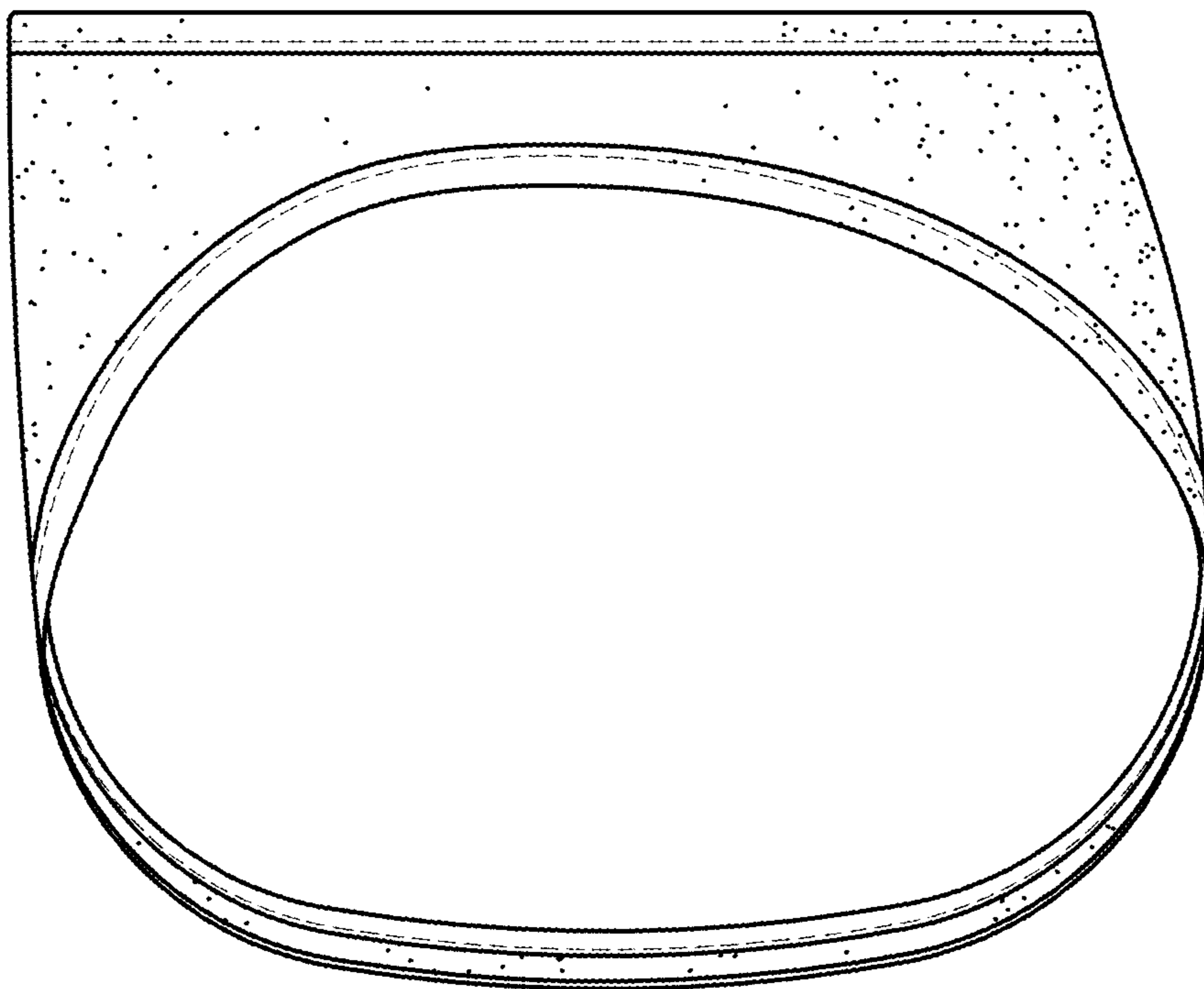


**FIG. 10**

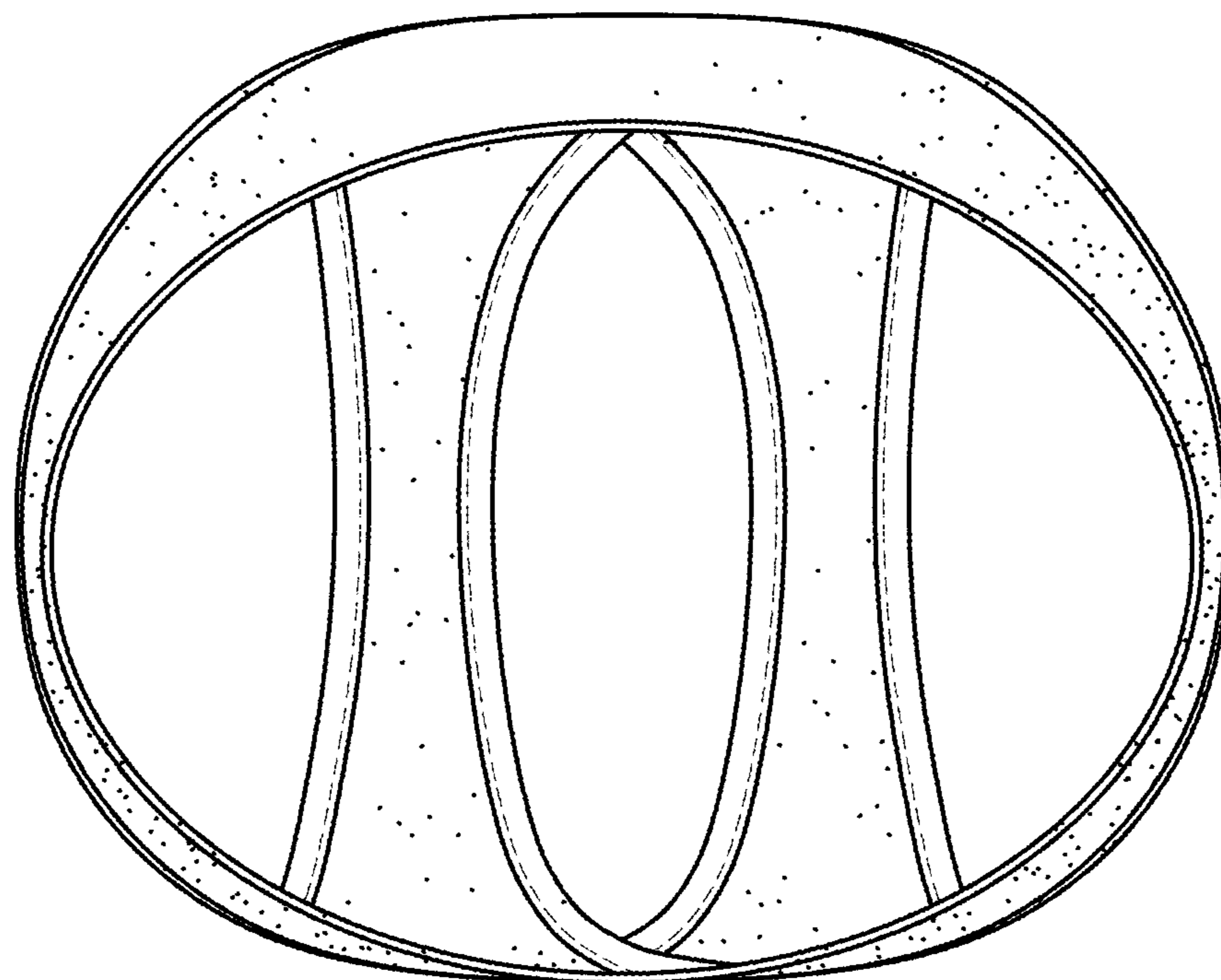




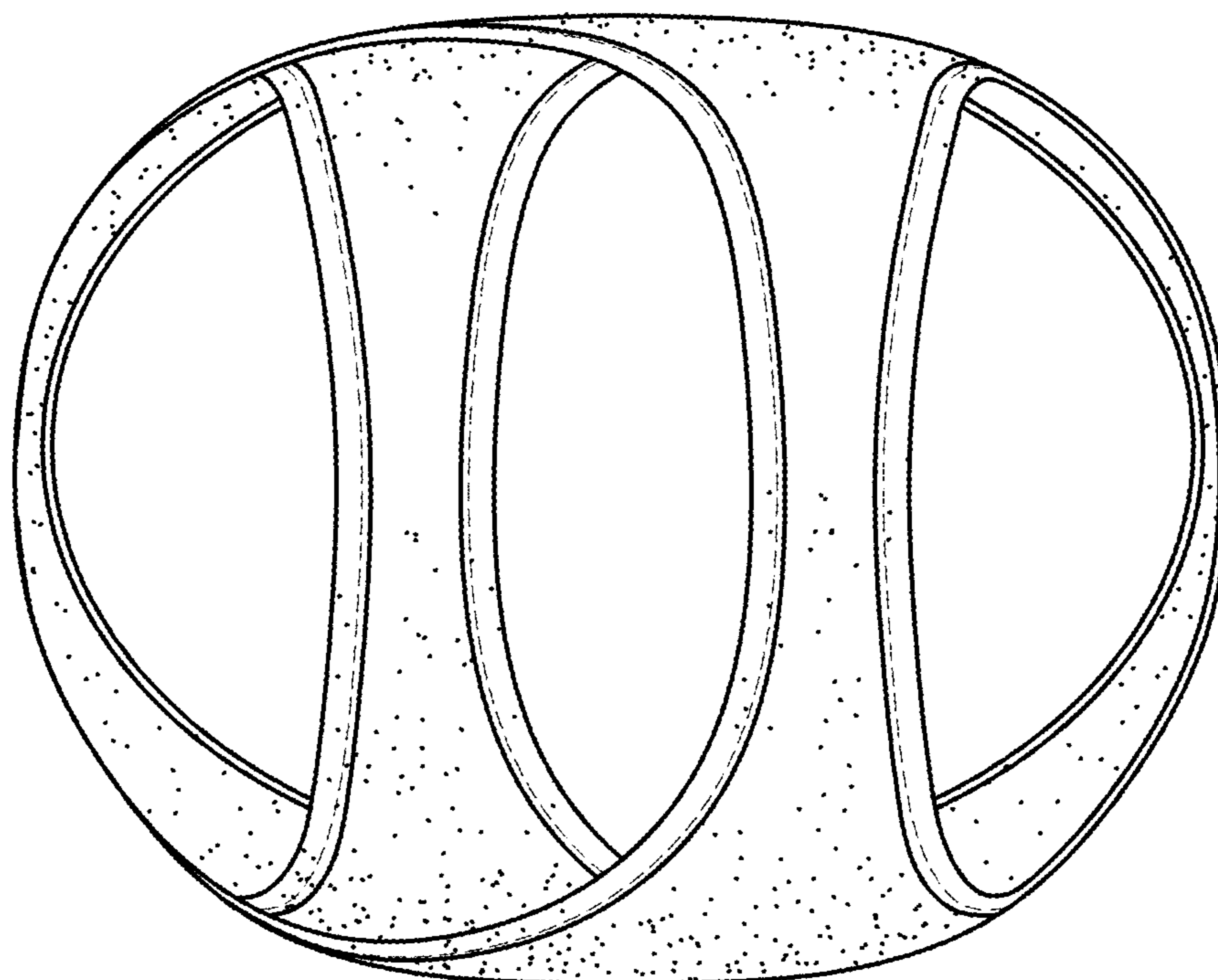
**FIG. 11**



**FIG. 12**



**FIG. 13**



**FIG. 14**