



US00D895866S

(12) **United States Design Patent** (10) **Patent No.:** **US D895,866 S**
Jeong et al. (45) **Date of Patent:** **** Sep. 8, 2020**

(54) **HEAD LAMP FOR AN AUTOMOBILE**

F21V 21/04; B60Q 1/30; B60Q 1/2607;
B60Q 1/2696; B62J 6/00; B62J 6/04

(71) Applicants: **Hyundai Motor Company**, Seoul
(KR); **Kia Motors Corporation**, Seoul
(KR)

See application file for complete search history.

(72) Inventors: **Da Young Jeong**, Seongnam-si (KR);
Yu Ra Cha, Seoul (KR); **Yun Seok**
Oh, Ansan-si (KR); **Hyeong Seon Kim**,
Gunpo-si (KR); **Oh Young Kwon**,
Suwon-si (KR); **Jae Min Choi**,
Cheongju-si (KR)

(56) **References Cited**

U.S. PATENT DOCUMENTS

D720,870 S *	1/2015	Lim	D26/28
D740,976 S *	10/2015	Ko	D26/28
D745,717 S *	12/2015	Wu	D26/28
D759,863 S *	6/2016	Shim	D26/28
D788,956 S *	6/2017	Hong	D26/28
D812,273 S *	3/2018	Wu	D26/28
D812,275 S *	3/2018	Wu	D26/28
D834,733 S *	11/2018	Katagiri	D26/28
D849,291 S *	5/2019	Wu	D26/28
D883,539 S *	5/2020	Yu	D26/28

(73) Assignees: **Hyundai Motor Company**, Seoul
(KR); **Kia Motors Corporation**, Seoul
(KR)

* cited by examiner

(**) Term: **15 Years**

Primary Examiner — Natasha Vujcic

(21) Appl. No.: **35/507,163**

(74) *Attorney, Agent, or Firm* — Mintz Levin Cohn Ferris
Glovsky and Popeo, P.C.; Peter F. Corless; Carolina E.
Säve

(22) Filed: **Jan. 22, 2019**

(80) **Hague Agreement Data**

Int. Filing Date: **Jan. 22, 2019**
Int. Reg. No.: **DM/201444**
Int. Reg. Date: **Jan. 22, 2019**
Int. Reg. Pub. Date: **Aug. 2, 2019**

(57) **CLAIM**

The ornamental design for head lamp for an automobile, as
shown and described.

(30) **Foreign Application Priority Data**

Aug. 31, 2018 (KR) 30-2018-0040833

(51) **LOC (12) Cl.** **26-06**

(52) **U.S. Cl.**
USPC **D26/28**

(58) **Field of Classification Search**
USPC D26/28
CPC F21S 48/00; F21S 48/10; F21S 48/115;
F21S 48/225; F21S 48/1233; F21S
48/1266; F21S 48/1388; F21S 48/2266;

DESCRIPTION

- 1. Head lamp for an automobile
- 1.1 : Perspective
- 1.2 : Front
- 1.3 : Back
- 1.4 : Left
- 1.5 : Right
- 1.6 : Top
- 1.7 : Bottom

1 Claim, 7 Drawing Sheets

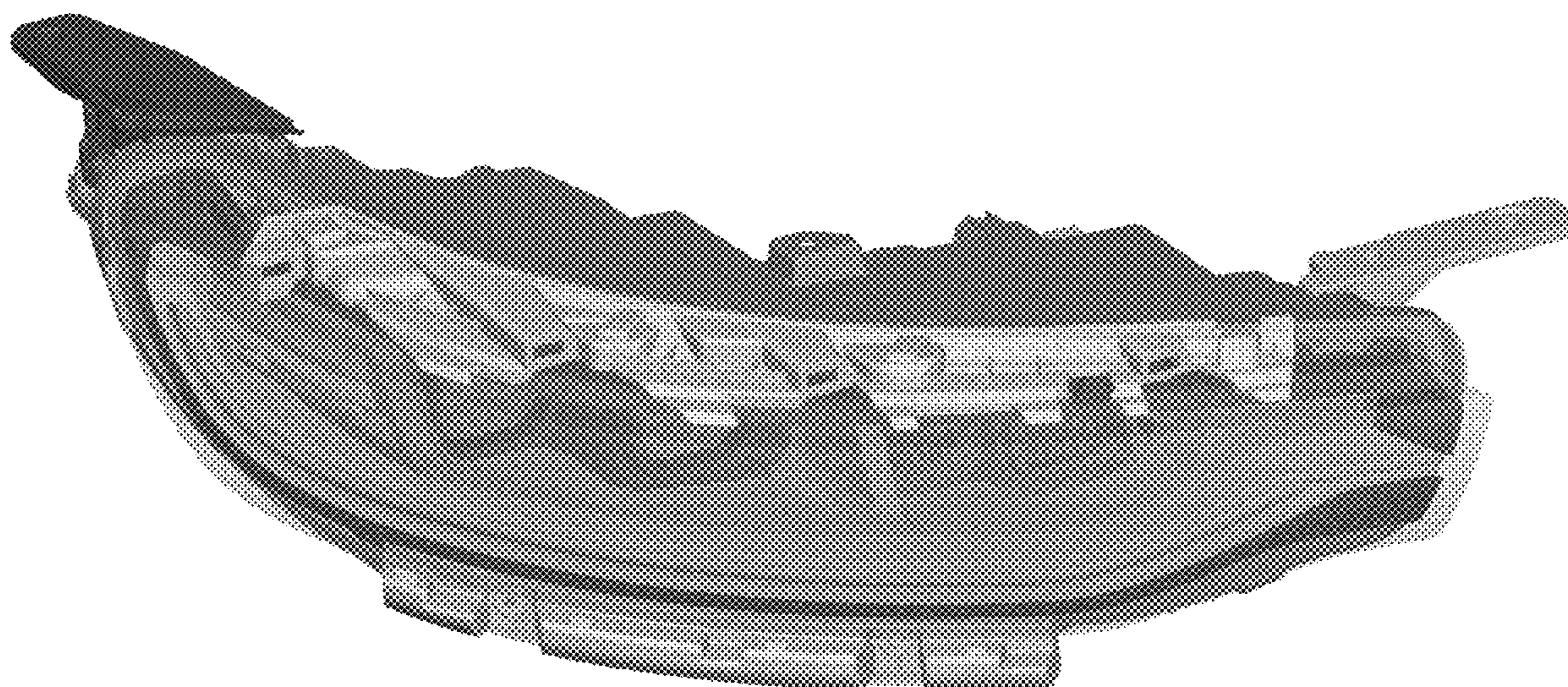

1.1

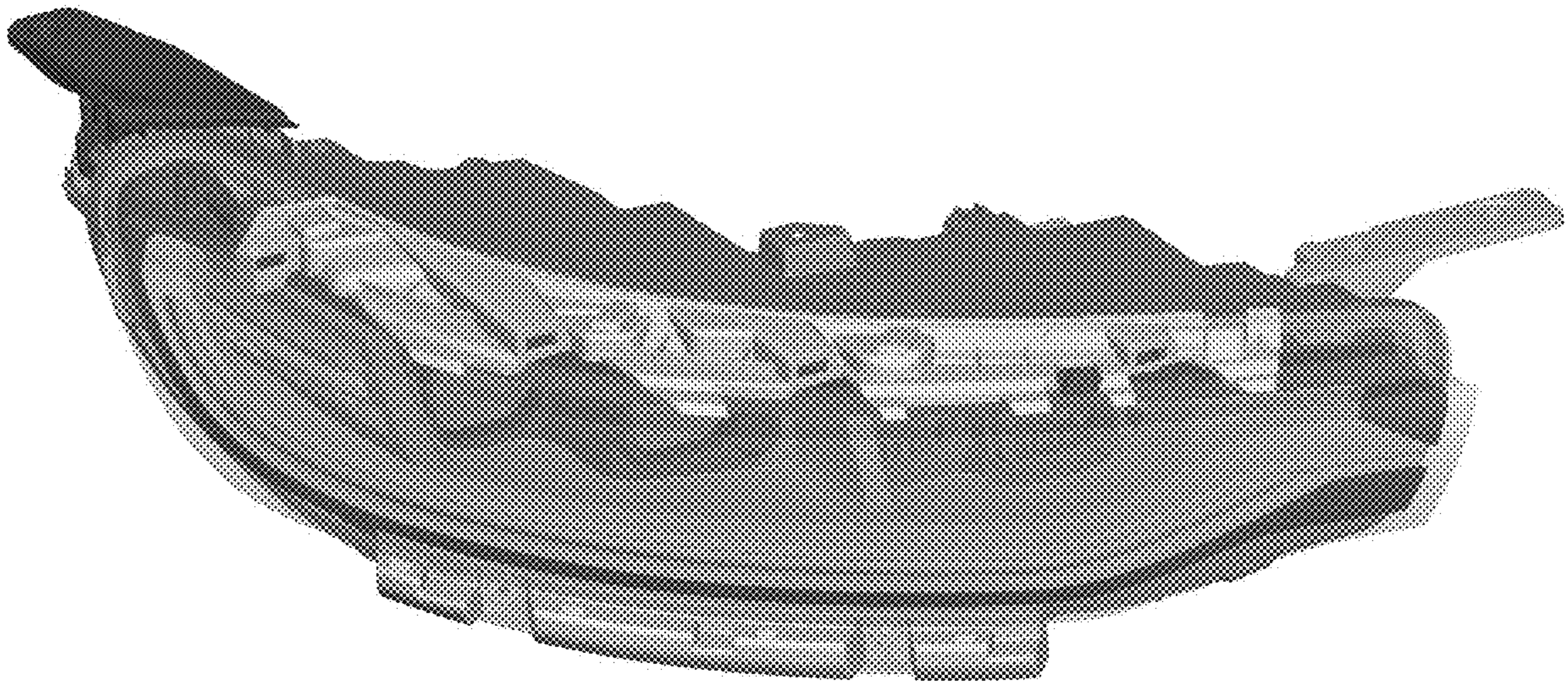

1.2

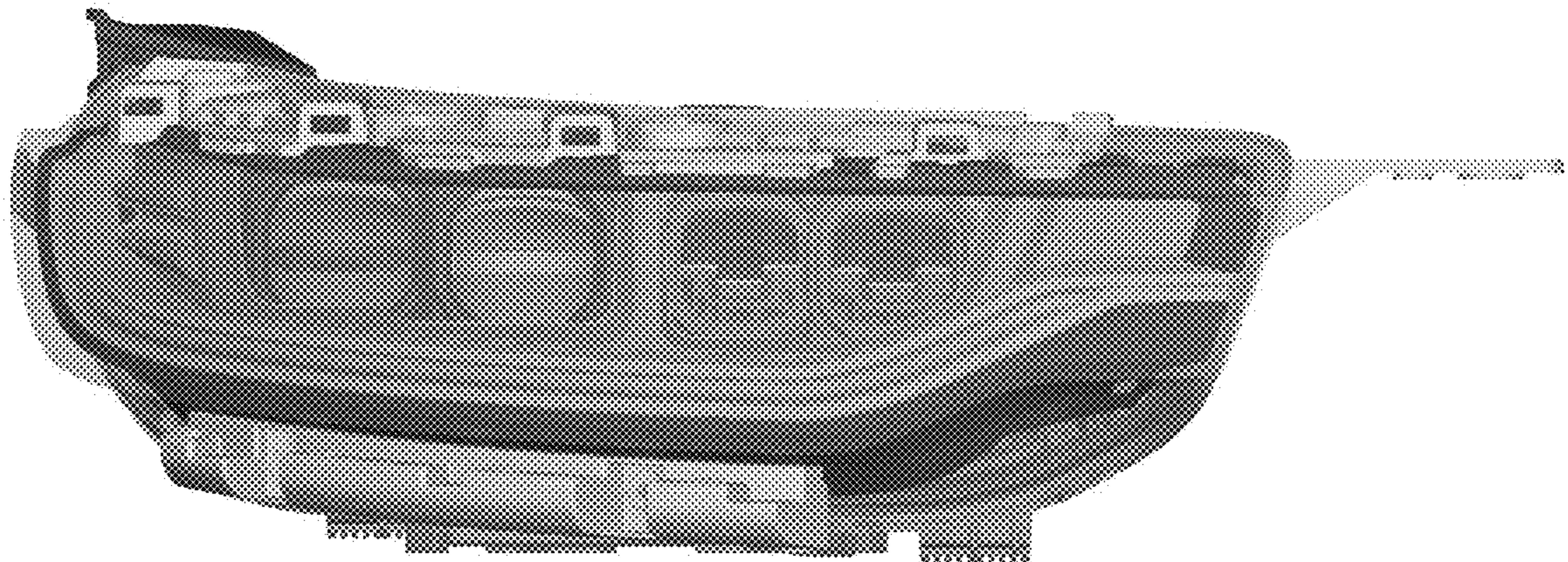

1.3

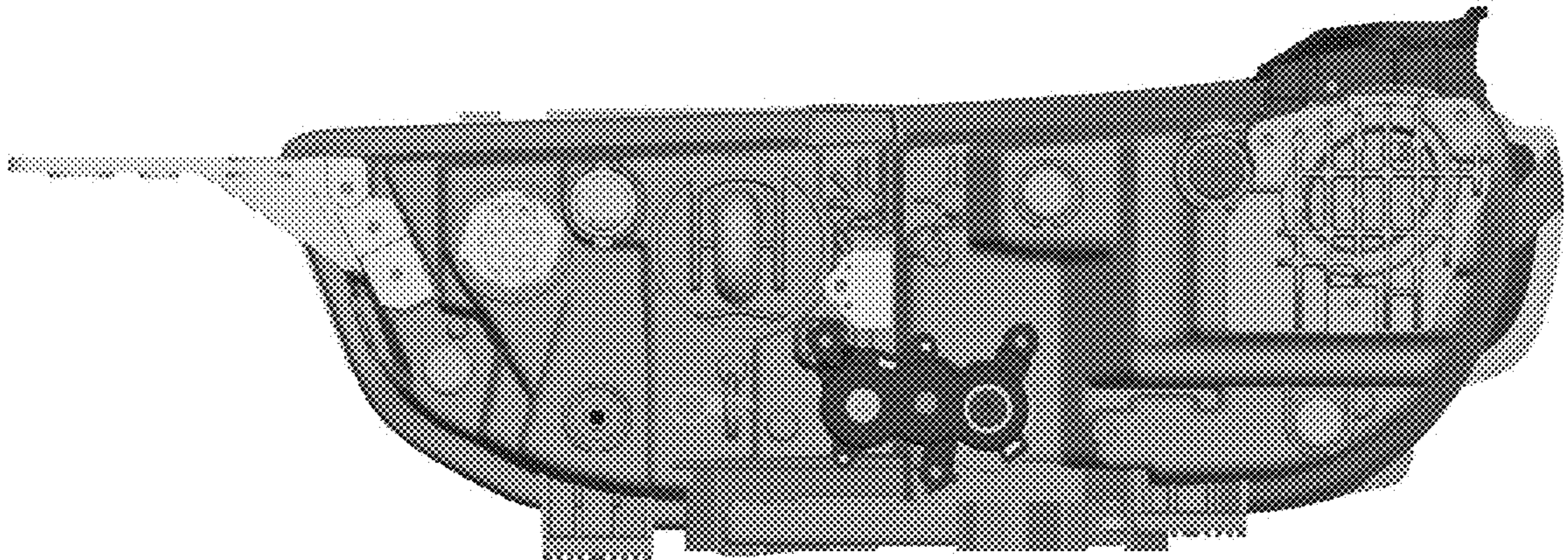

1.4

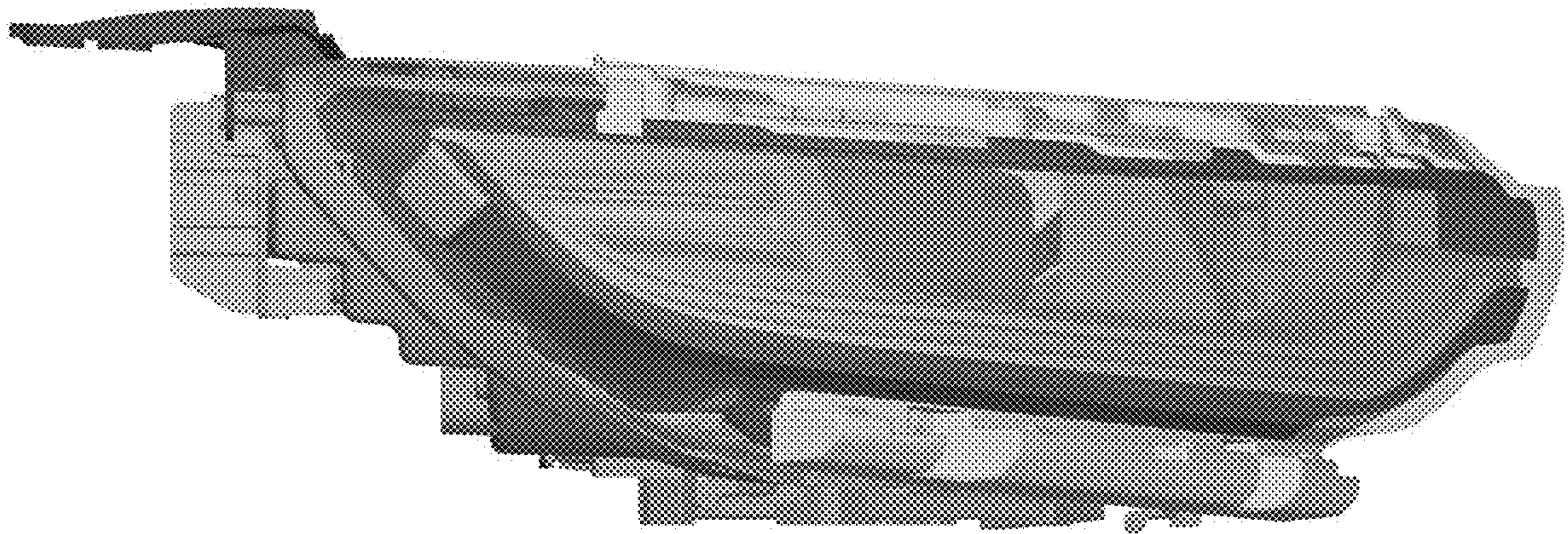

1.5

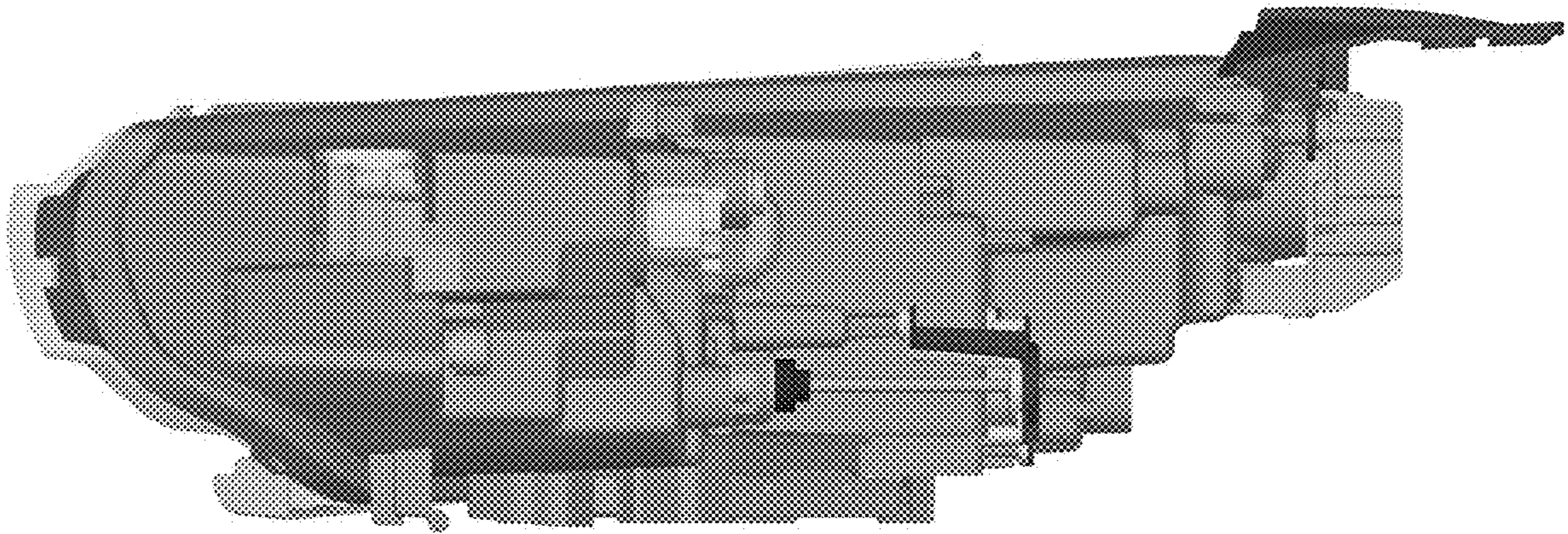

1.6

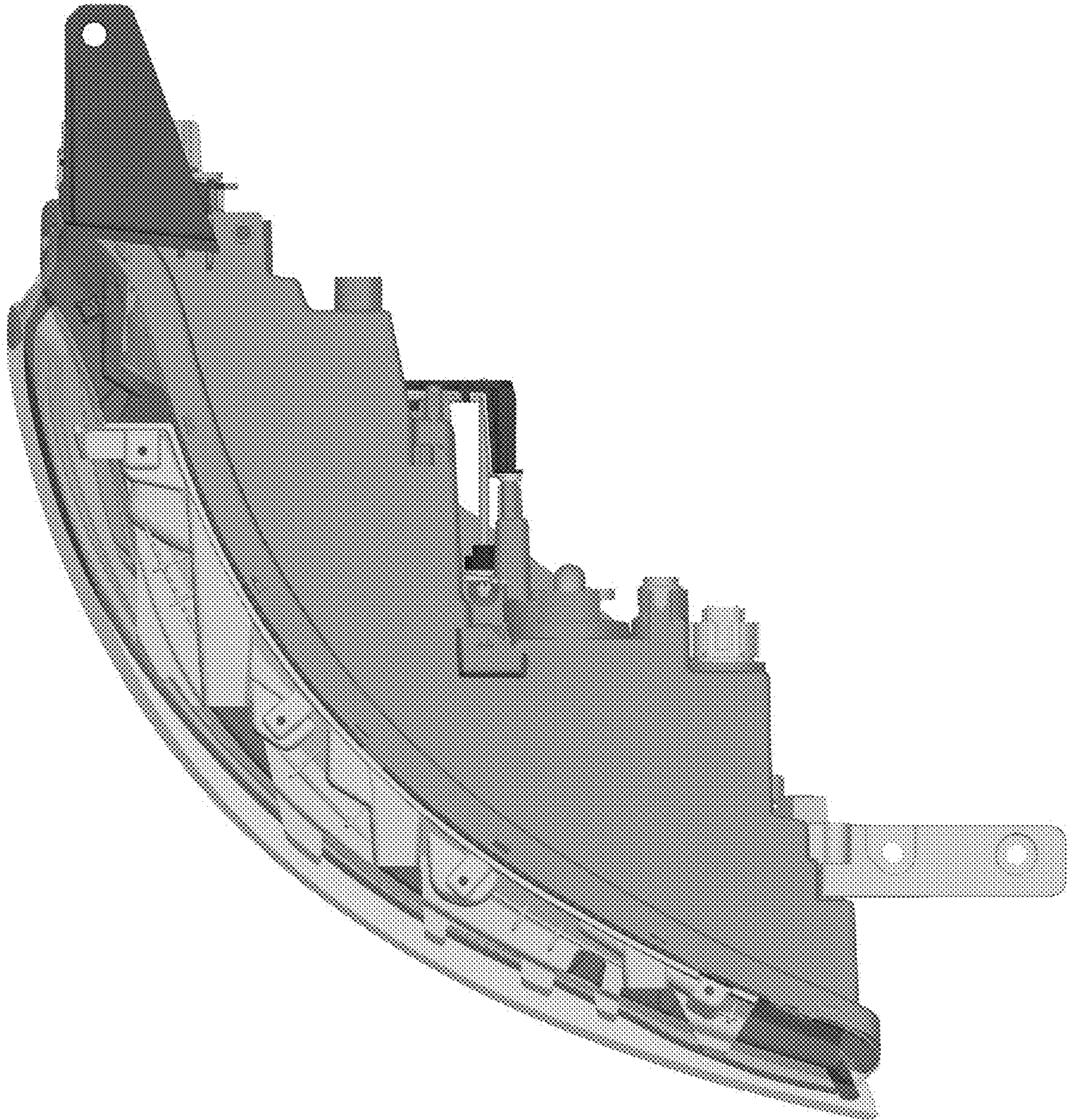

1.7

