



US00D895833S

(12) **United States Design Patent** (10) **Patent No.:** **US D895,833 S**  
**Ohmura et al.** (45) **Date of Patent:** **\*\* Sep. 8, 2020**

(54) **SAMPLE HOLDER FOR IONIZED SAMPLE ANALYSIS**

(71) Applicant: **HAMAMATSU PHOTONICS K.K.**,  
Hamamatsu-shi, Shizuoka (JP)

(72) Inventors: **Takayuki Ohmura**, Hamamatsu (JP);  
**Masahiro Kotani**, Hamamatsu (JP)

(73) Assignee: **HAMAMATSU PHOTONICS K.K.**,  
Hamamatsu-shi, Shizuoka (JP)

(\*\*) Term: **15 Years**

(21) Appl. No.: **29/656,989**

(22) Filed: **Jul. 18, 2018**

(30) **Foreign Application Priority Data**

Jan. 19, 2018 (JP) ..... 2018-000947

(51) **LOC (12) Cl.** ..... **24-02**

(52) **U.S. Cl.**  
USPC ..... **D24/225; D24/224**

(58) **Field of Classification Search**  
USPC ..... D24/216, 223–227, 229–232; D9/537,  
D9/545, 549, 756–760, 761; D3/203.1,  
D3/203.2; D10/81; D28/8

(Continued)

(56) **References Cited**

**U.S. PATENT DOCUMENTS**

D218,819 S 9/1970 Rubin  
D227,744 S \* 7/1973 Mitchko ..... D3/203.2  
(Continued)

**OTHER PUBLICATIONS**

Makeup Tool Kit 33 in 1 Make up Cosmetics Including Eyeshadow  
Blush Powder Lip gloss With Makeup Box Makeup Set for Gift.  
Online, published date unknown. Retrieved on Nov. 20, 2019 from

URL: <https://kozeez.conn/products/makup-tool-kit-33-in-1-make-up-cosmetics-including-eyeshadow-blush-powder-lip-gloss-with-makeup-box>.\*

(Continued)

*Primary Examiner* — Susan Bennett Hattan

*Assistant Examiner* — Omeed Agilee

(74) *Attorney, Agent, or Firm* — Faegre Drinker Biddle & Reath LLP

(57) **CLAIM**

The ornamental design for a sample holder for ionized sample analysis, as shown and described.

**DESCRIPTION**

FIG. 1 is a front view of a sample holder for ionized sample analysis of the present invention;  
FIG. 2 is a rear view thereof;  
FIG. 3 is a top plan view thereof;  
FIG. 4 is a bottom plan view thereof;  
FIG. 5 is a right side view thereof;  
FIG. 6 is a left side view thereof;  
FIG. 7 is a perspective view thereof;  
FIG. 8 is an enlarged view showing a portion of FIG. 1 defined by lines 8-8 and 8'-8';  
FIG. 9 is an enlarged view showing a portion of FIG. 7 defined by lines 9-9 and 9'-9';  
FIG. 10 is an enlarged view showing a portion of FIG. 9 defined by lines 10-10 and 10'-10';  
FIG. 11 is an enlarged cross-sectional view along the line 11-11 in FIG. 8, in the area designated by 11'-11' in FIG. 8;  
FIG. 12 is an enlarged cross-sectional view along the line 12-12 in FIG. 8, in the area designated by 12'-12' in FIG. 8;  
FIG. 13 is an enlarged cross-sectional view along the line 13-13 in FIG. 8, in the area designated by 13'-13' in FIG. 8;  
FIG. 14 is an enlarged cross-sectional view along the line 14-14 in FIG. 8, in the area designated by 14'-14' in FIG. 8;  
FIG. 15 is an enlarged cross-sectional view along the line 15-15 in FIG. 8, in the area designated by 15'-15' in FIG. 8;  
FIG. 16 is an enlarged cross-sectional view along the line 16-16 in FIG. 8, in the area designated by 16'-16' in FIG. 8;  
and,

(Continued)

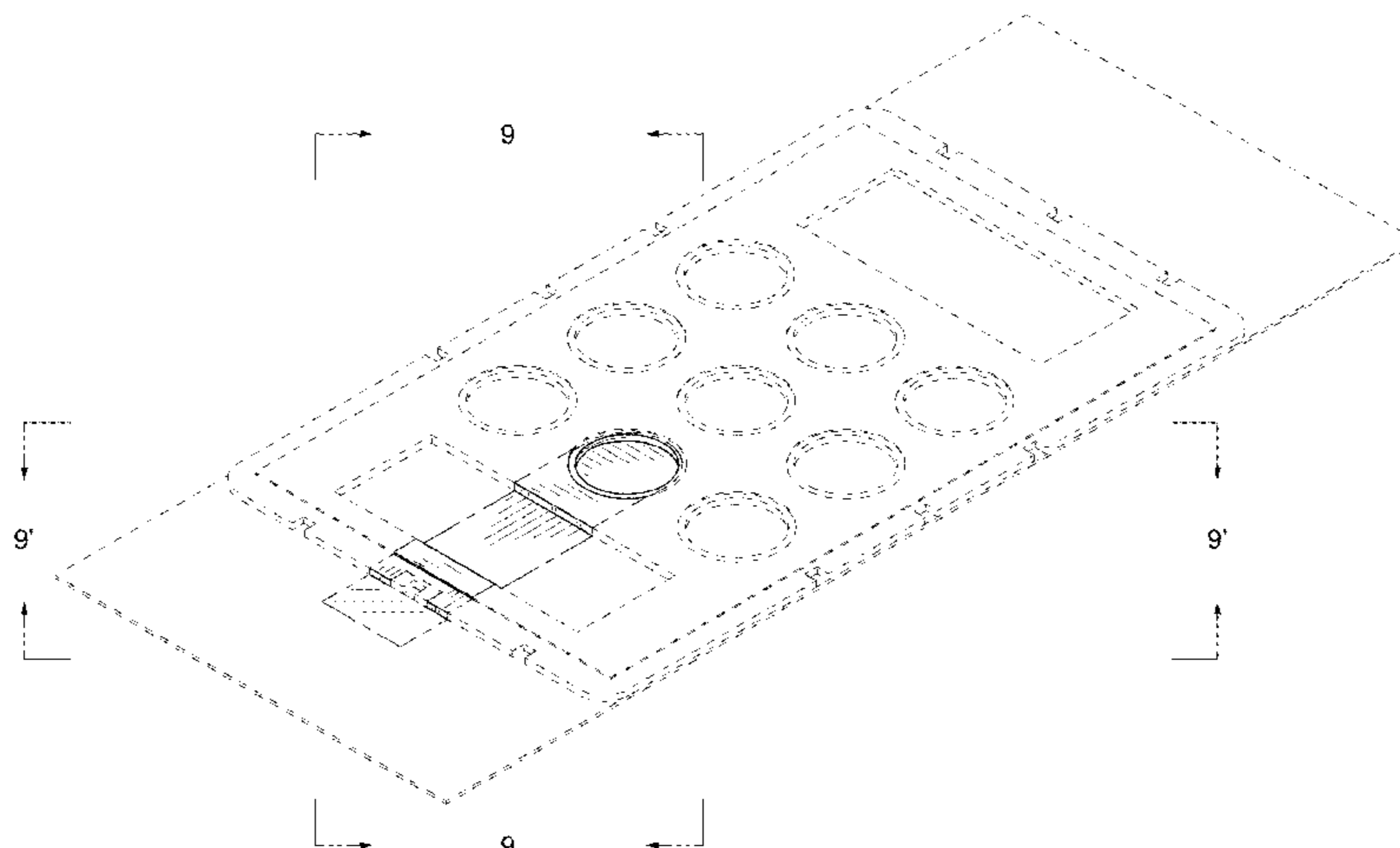

FIG. 17 is an enlarged cross-sectional view along the line 17-17 in FIG. 8.

The features shown in evenly-dashed broken lines depict portions of the sample holder for ionized sample analysis that form no part of the claimed design. The dot-dash-dot broken lines in the drawings represent the bounds of the claimed subject matter, the dot-dash-broken-lines depict the boundaries of the claim and form no part thereof. The dash-dot-dot-dash broken lines depict indicators for sectional views and enlarged views and depict boundaries in the enlarged sectional views and enlarged views, the dash-dot-dot-dash broken lines form no part of the claimed design.

**1 Claim, 17 Drawing Sheets**

(58) **Field of Classification Search**

CPC ... C12M 23/10; C12M 23/12; G01N 23/0033;  
G01N 23/0041; G01N 23/20025  
See application file for complete search history.

(56) **References Cited**

U.S. PATENT DOCUMENTS

D239,548 S *	4/1976	Schiff et al.	.....	D24/225
D273,898 S	5/1984	Valencia		
D274,261 S *	6/1984	Valencia	.....	D24/225
D277,699 S *	2/1985	Valencia	.....	D24/225
D290,042 S *	5/1987	Ford	.....	D24/226
5,349,436 A	9/1994	Fisch		
D351,475 S	10/1994	Gerber		
5,425,451 A	6/1995	Blase		
D376,685 S	12/1996	Weller et al.		
D397,831 S	9/1998	Stoecker		
D418,228 S	12/1999	Fisch		
D420,745 S	2/2000	Cardy		
D431,300 S	9/2000	Fisch		
D431,301 S	9/2000	Fisch		
D473,318 S	4/2003	Barbera-Guillem		
D491,276 S	6/2004	Langille		
D500,142 S	12/2004	Crisanti et al.		
D503,274 S *	3/2005	Roche	.....	D3/203.2
D510,883 S	10/2005	George		
D530,826 S *	10/2006	Rich	.....	D24/225
D540,953 S *	4/2007	Ramel	.....	D24/224
7,217,520 B2	5/2007	Tsinberg et al.		
D569,990 S	5/2008	Fisch		
7,409,698 B2 *	8/2008	Tjensvold	.....	G11B 33/0422 720/719
D596,753 S	7/2009	LaStella		
D596,758 S *	7/2009	Constable	.....	D24/230
D672,050 S *	12/2012	Lee	.....	D24/216
D673,295 S	12/2012	Motadel		
D680,227 S	4/2013	Berg		
D699,369 S	2/2014	Fonseca		
D702,364 S	4/2014	Iqbal et al.		

D722,385 S *	2/2015	Fonseca	.....	D24/224
9,034,634 B2	5/2015	Miller		
D733,313 S	6/2015	Kouge et al.		
D733,912 S	7/2015	Ito et al.		
D734,482 S *	7/2015	Peterman	.....	D24/216
D736,403 S *	8/2015	Hudson	.....	D24/216
D758,608 S *	6/2016	Behar	.....	D24/223
D786,448 S	5/2017	Ohsaka et al.		
D787,356 S	5/2017	Johnston		
D792,735 S	7/2017	Henry		
D800,184 S	10/2017	Suess et al.		
D800,336 S	10/2017	Chang et al.		
D806,890 S	1/2018	Williams et al.		
D806,892 S	1/2018	Walden, II et al.		
D812,767 S	3/2018	Osmus et al.		
D825,076 S	8/2018	Librach et al.		
D827,857 S	9/2018	Buschtez		
D831,275 S	10/2018	Maynard		
D838,001 S	1/2019	Ito et al.		
D840,049 S	2/2019	Schulz et al.		
D841,183 S	2/2019	Walden, II et al.		
D843,013 S	3/2019	Ito et al.		
D854,184 S	7/2019	Ito et al.		
D855,203 S	7/2019	Katsumata et al.		
D855,206 S	7/2019	Ito et al.		
D855,207 S	7/2019	Ito et al.		
D855,208 S	7/2019	Ito et al.		
D855,209 S	7/2019	Ito et al.		
D855,210 S	7/2019	Ito et al.		
D867,612 S	11/2019	Ohmura et al.		
D867,613 S	11/2019	Ohmura et al.		
D867,670 S	11/2019	Tawil et al.		
2005/0237607 A1 *	10/2005	Tenney	.....	G01N 1/2813 359/392
2008/0056948 A1	3/2008	Dale et al.		
2009/0253582 A1	10/2009	Pena et al.		
2012/0045792 A1	2/2012	Cohen et al.		
2012/0142026 A1	6/2012	Miller et al.		
2015/0330776 A1	11/2015	Hayashi et al.		
2016/0175840 A1	6/2016	Ingber et al.		

OTHER PUBLICATIONS

“Custom 6Color Highlighter Makeup Packaging Eyeshadow Palette Container With Mirror”, Nov. 10, 2019.  
Office Action dated Dec. 9, 2019 in U.S. Appl. No. 29/657,001.  
Office Action dated Dec. 10, 2019 in U.S. Appl. No. 29/656,985.  
Makeup palette. Online, published date unknown. Retrieved on Dec. 5, 2019 from URL: <https://www.wallpaperflare.com/search?wallpaper=makeup+palette>.  
“21 Colors Eyeshadow Palette, Everfavor Eye Shadow Makeup Palette Shimmer Eyeshadow Palettes Baked Eye Shadows Cosmetics Pallet with Galaxy Colors(21 Color, 04),” <https://www.amazon.com/professional-Cosmetics-Eyeshadow-Palette-Everfavor/dp/B07596P2XN>, May 26, 2020.  
Notice of Allowance dated Jun. 10, 2020 in Design U.S. Appl. No. 29/656,968.

\* cited by examiner

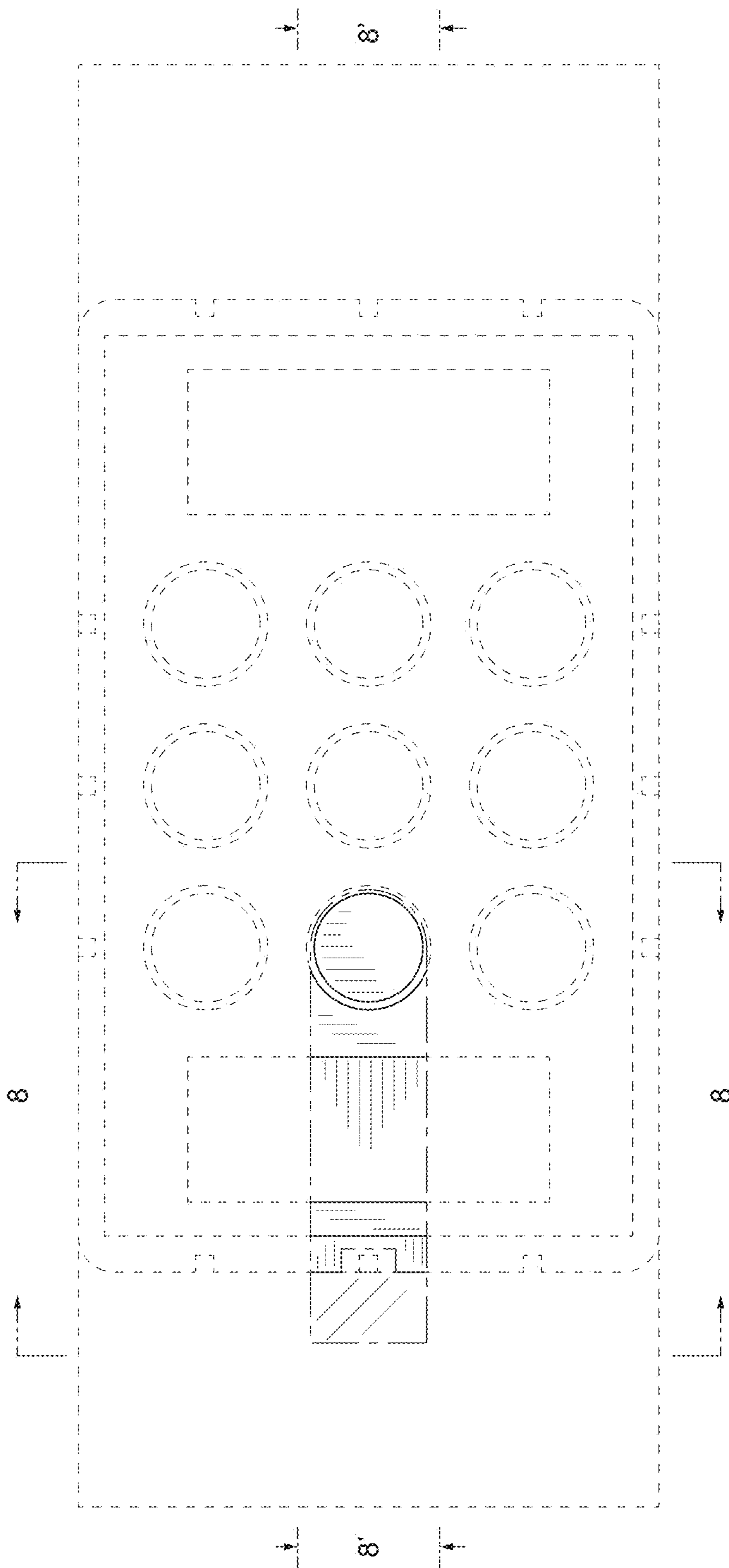

FIG. 1

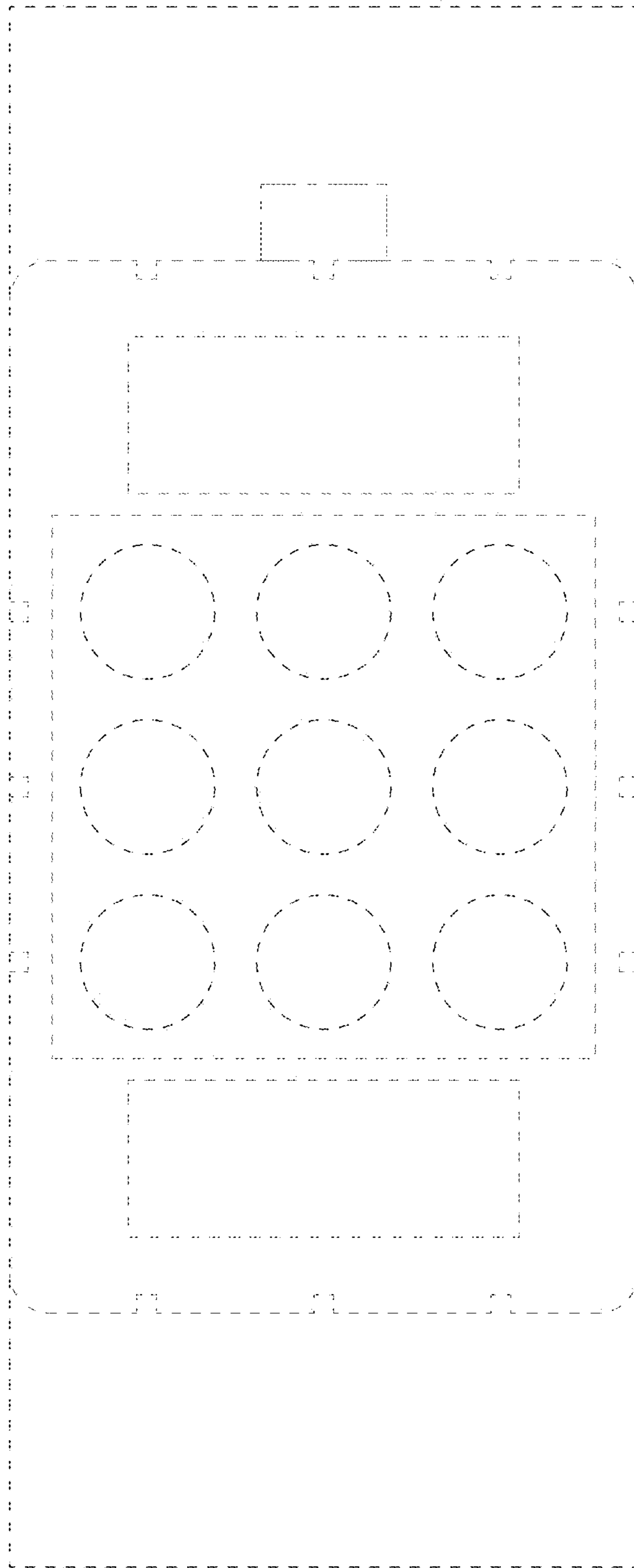

FIG. 2

FIG. 3

FIG. 3

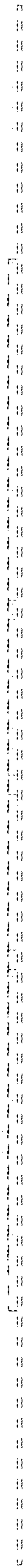

FIG. 4

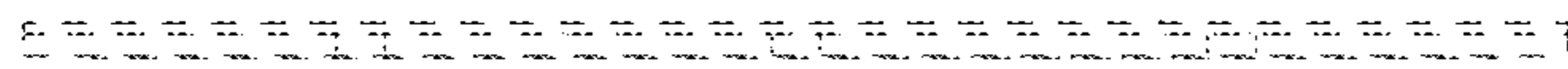

FIG. 5

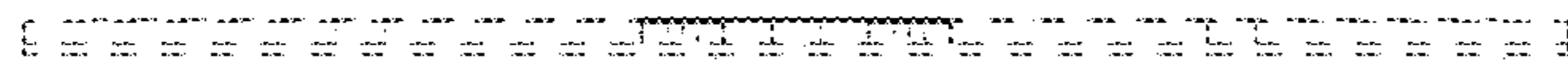
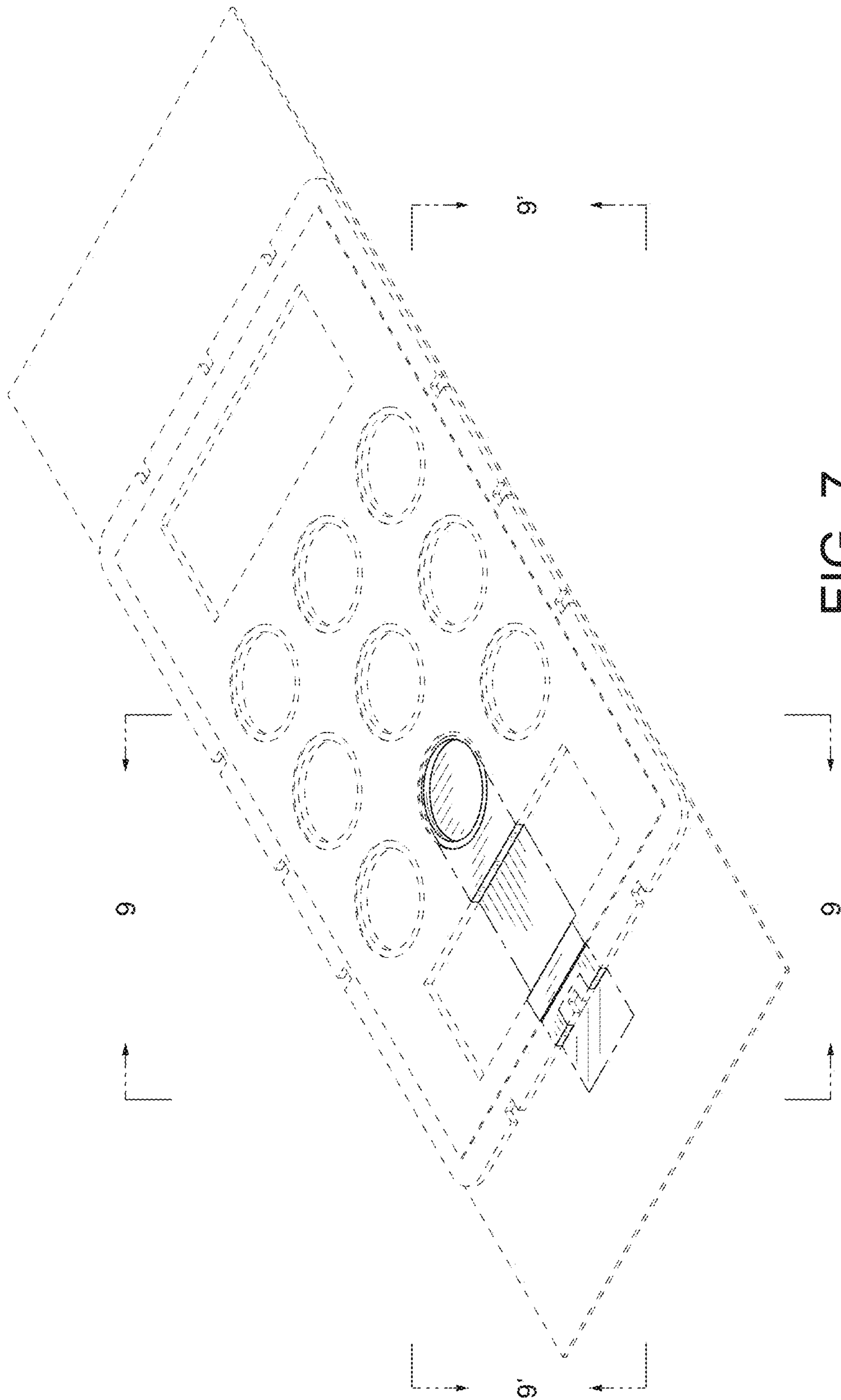

FIG. 6





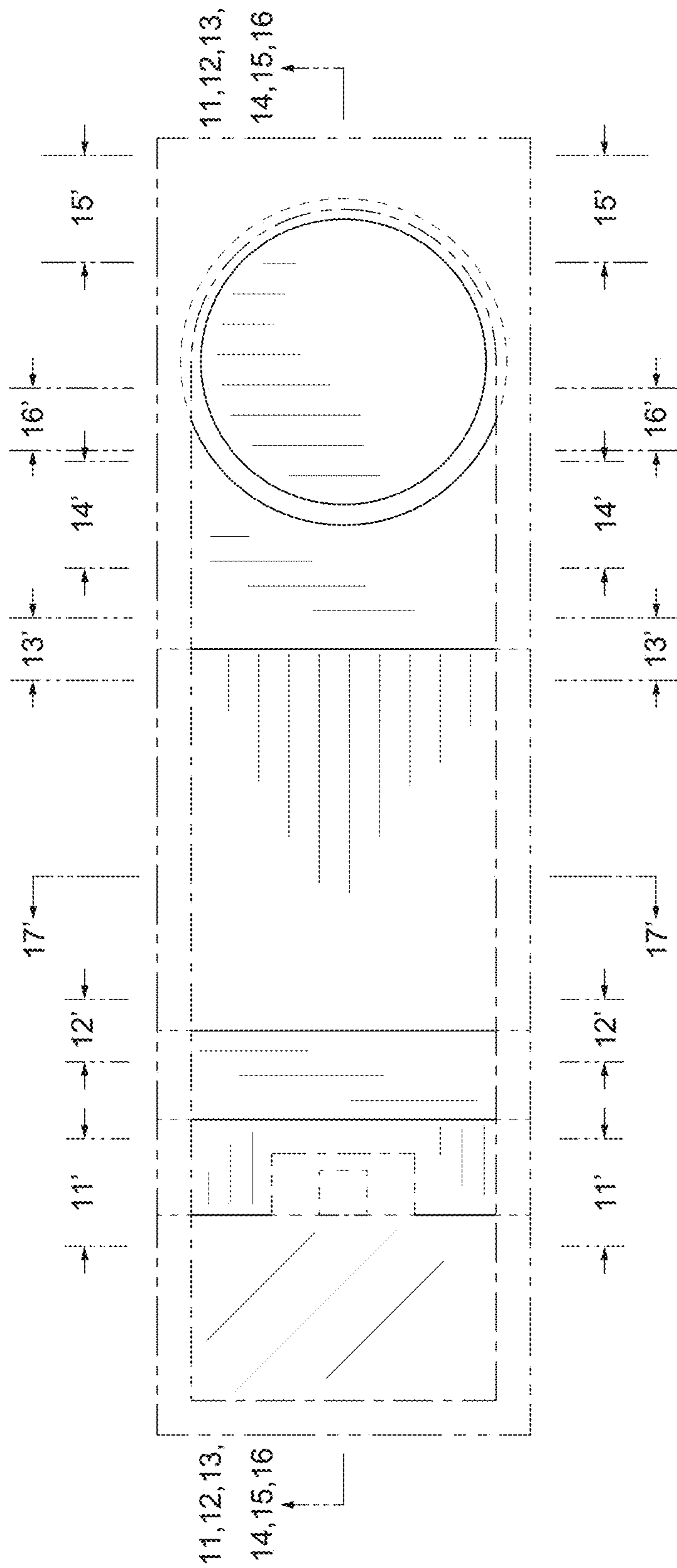

FIG. 8

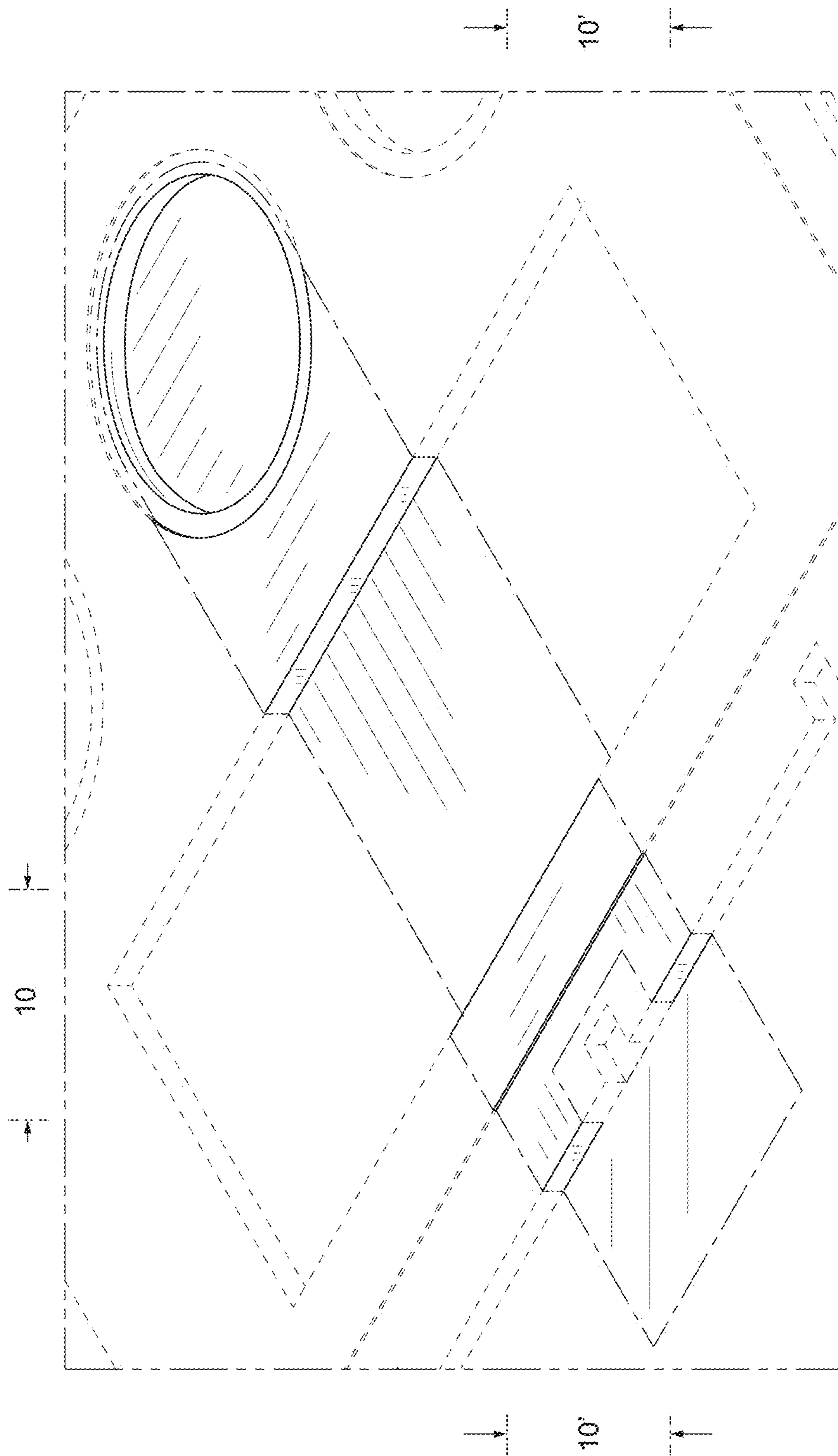

FIG. 9

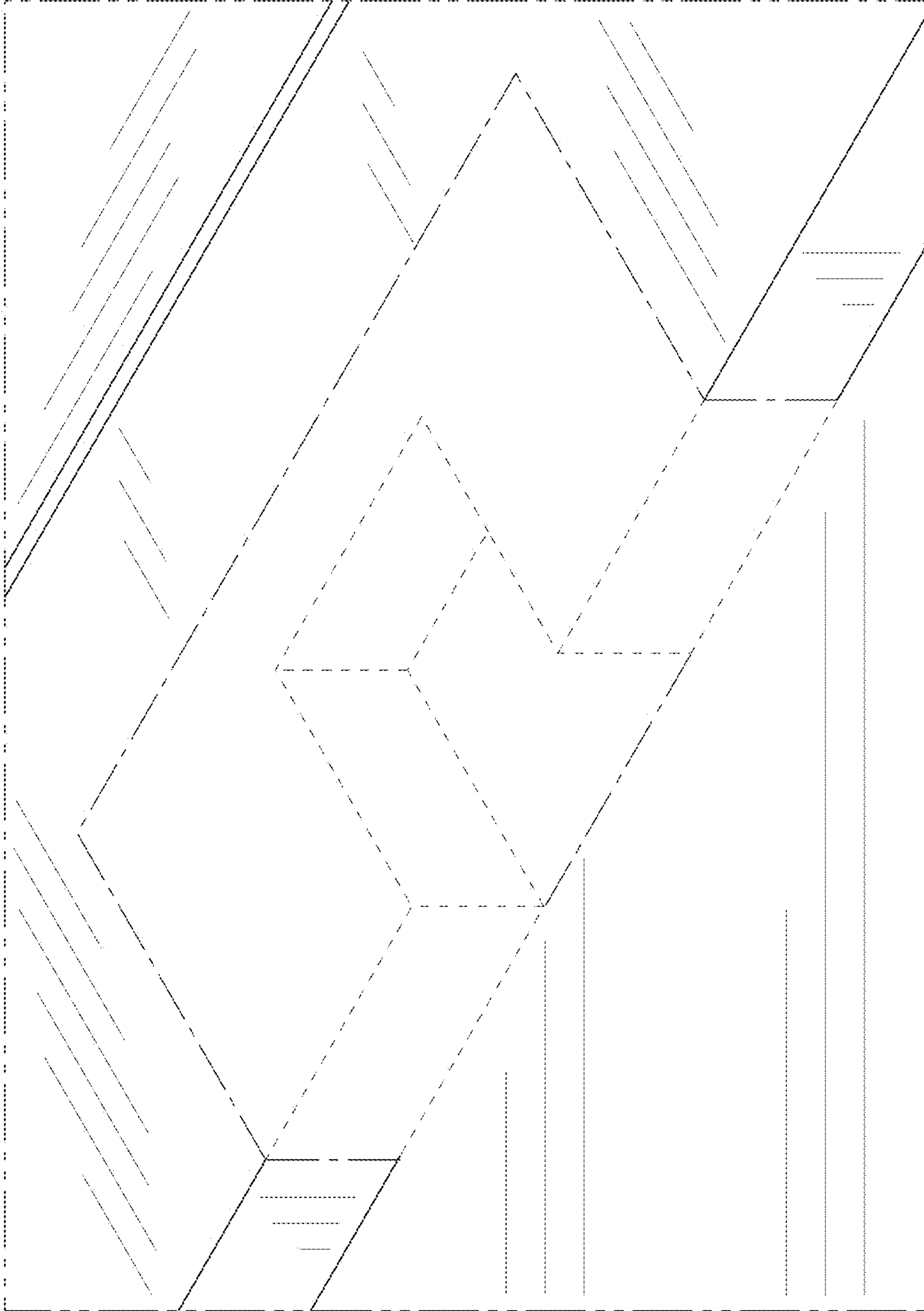

FIG. 10

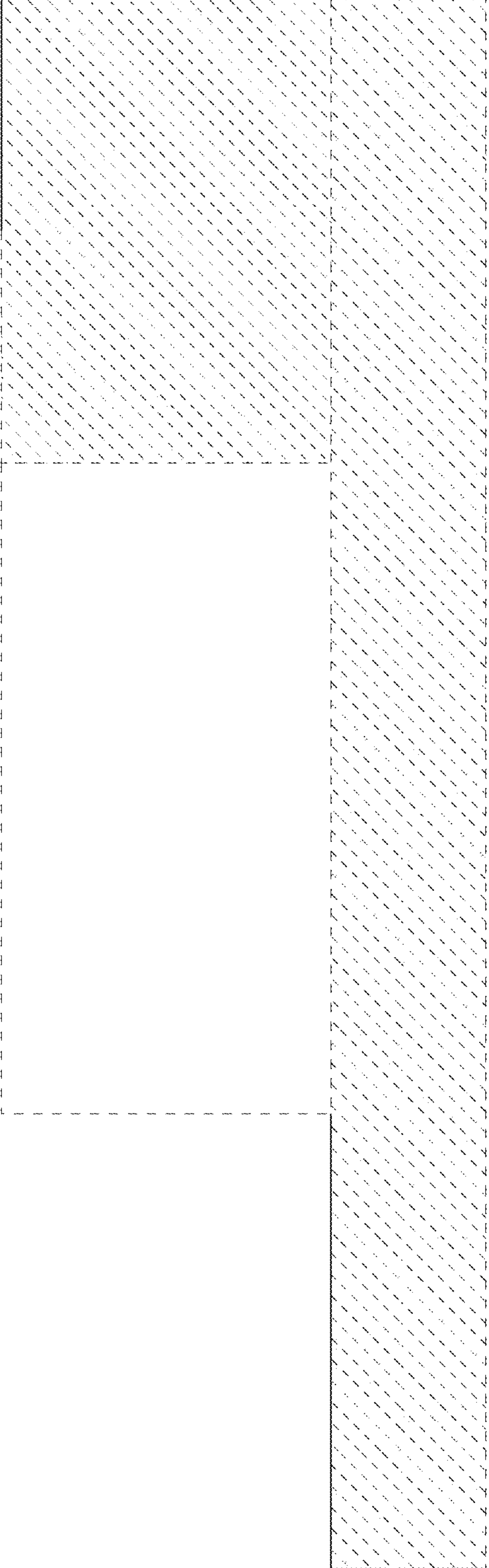

FIG. 11

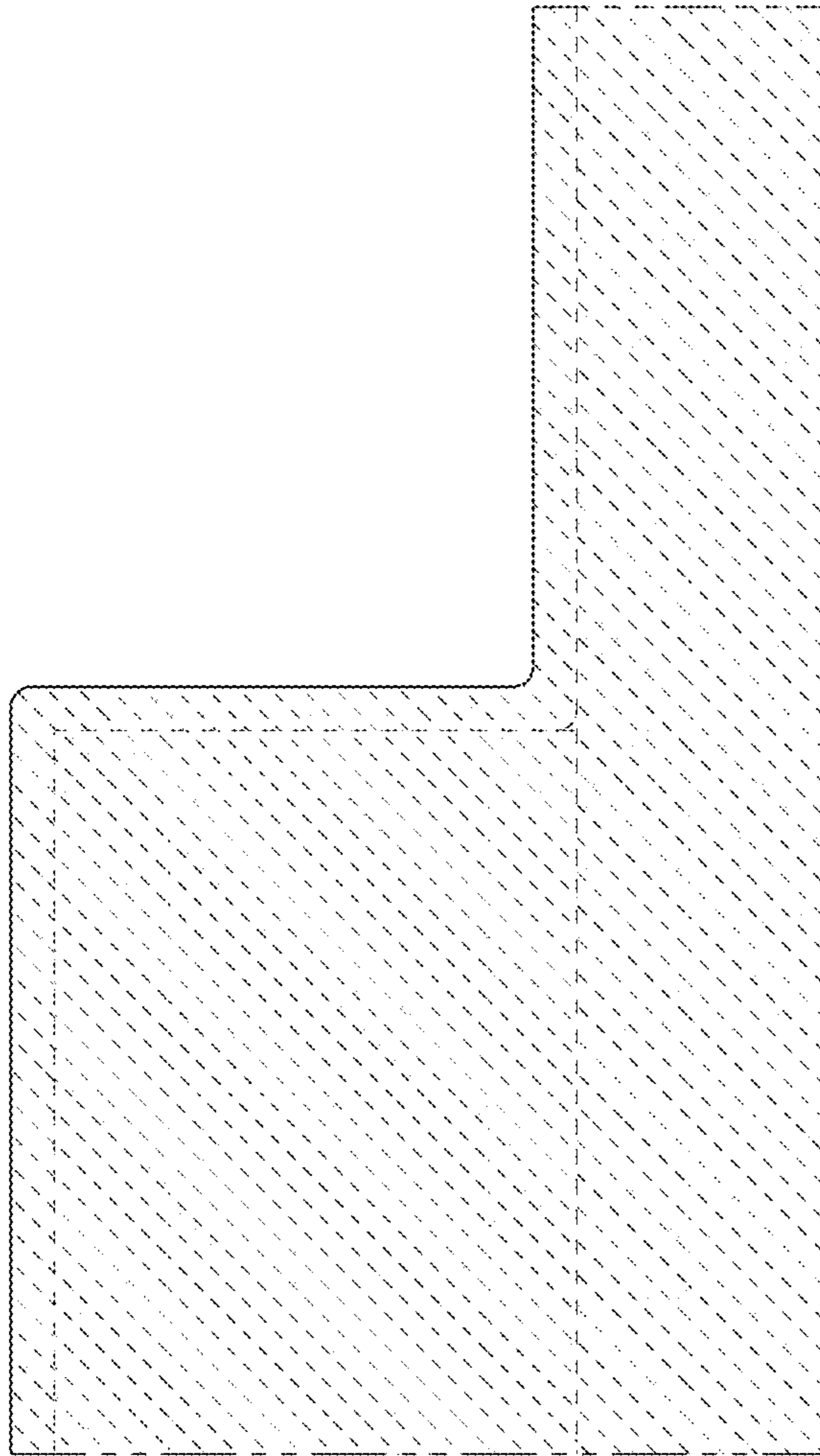

FIG. 12

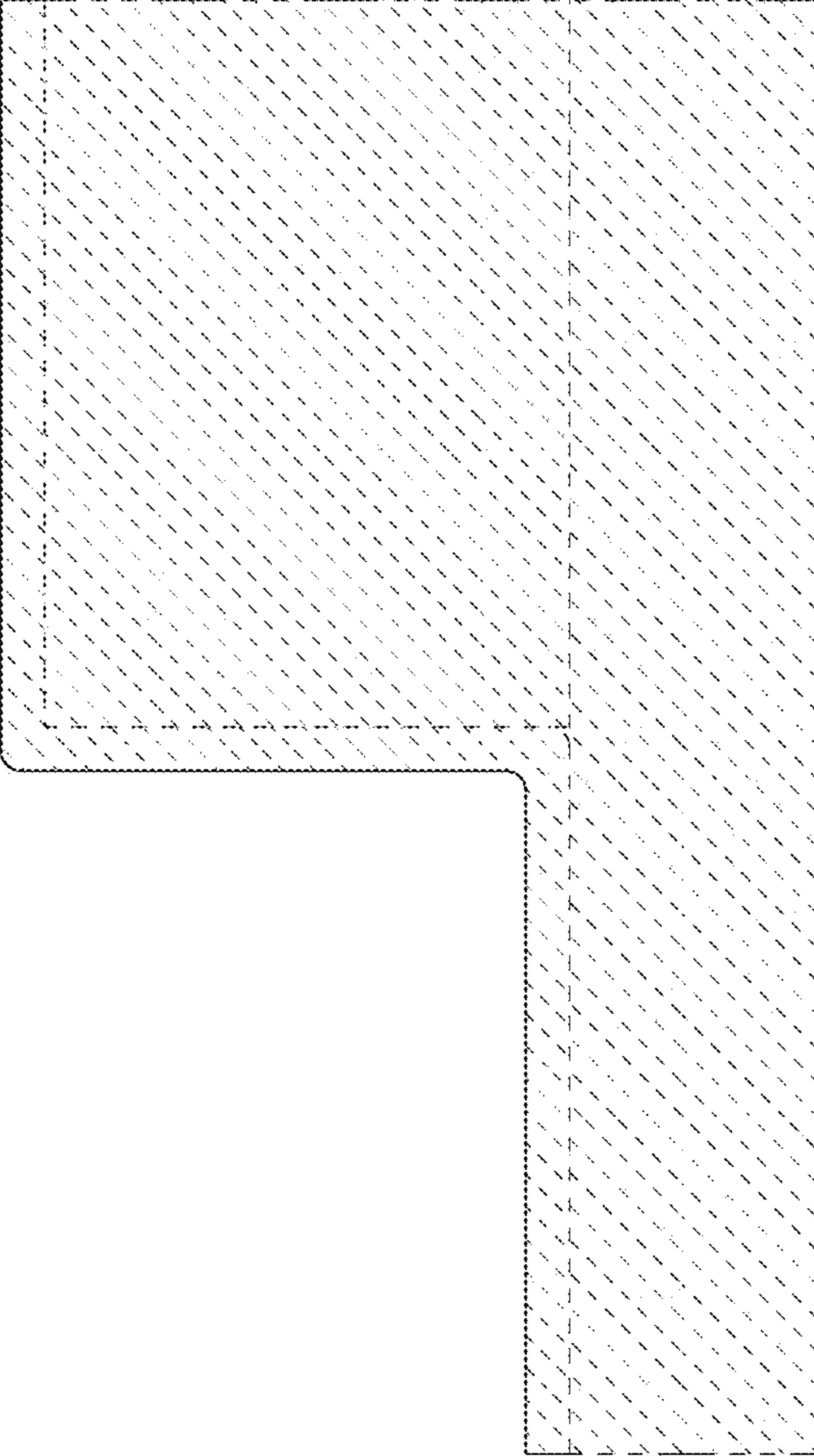

FIG. 13

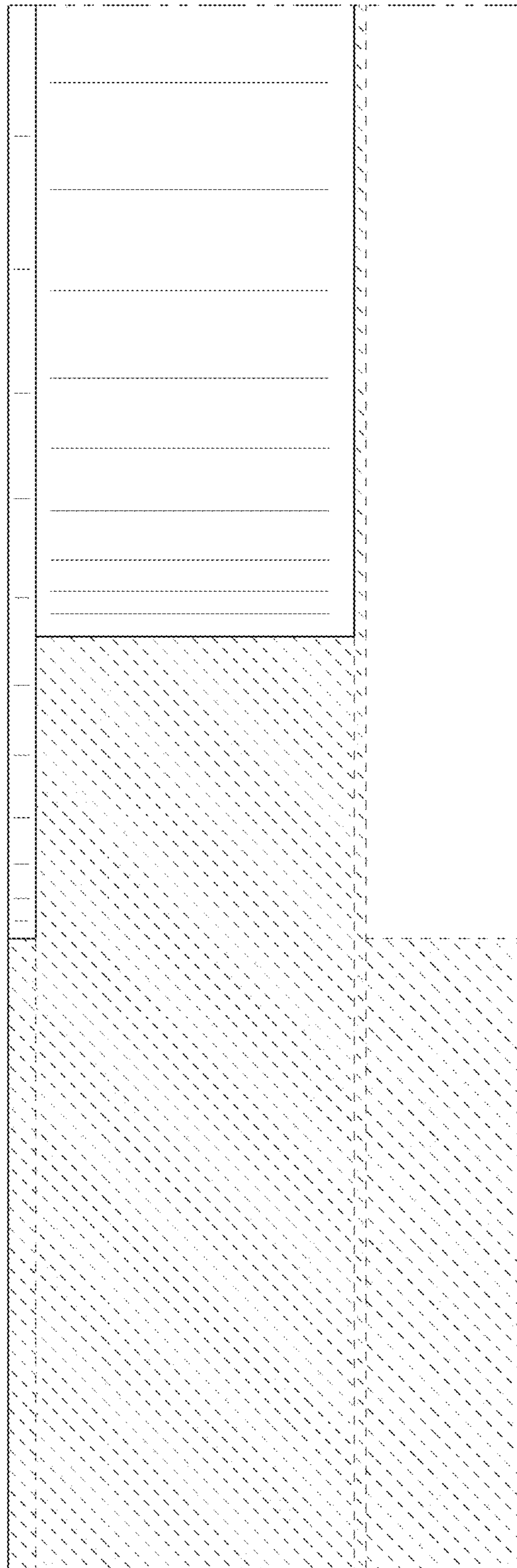

FIG. 14



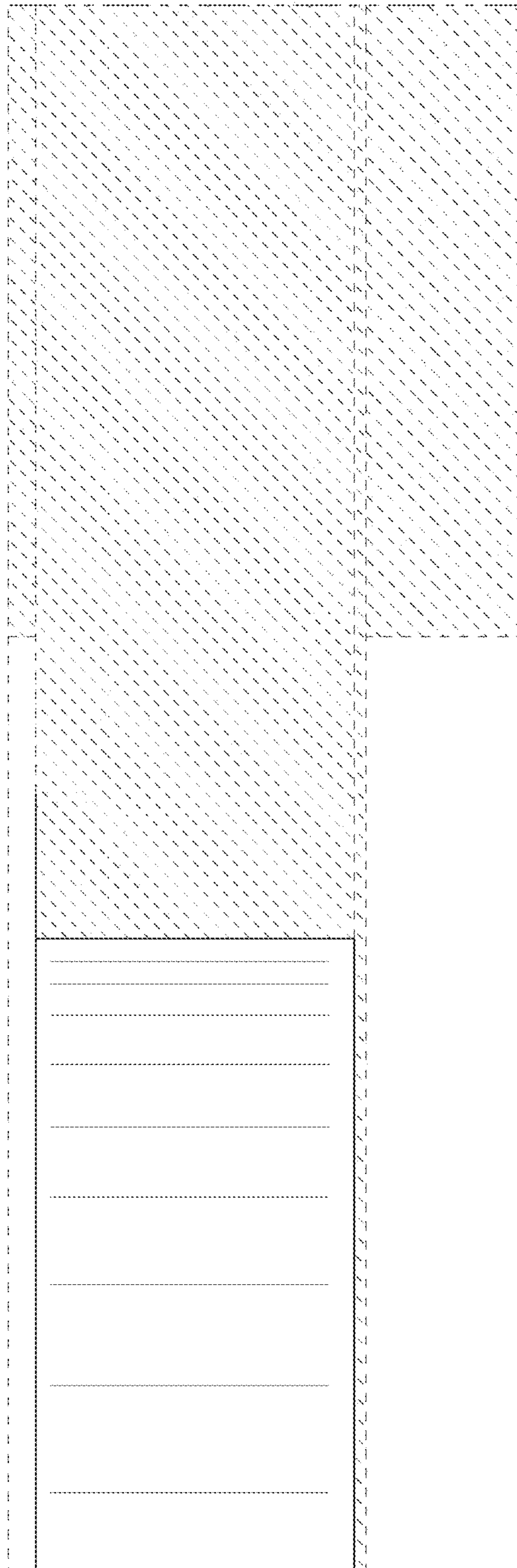

FIG. 15

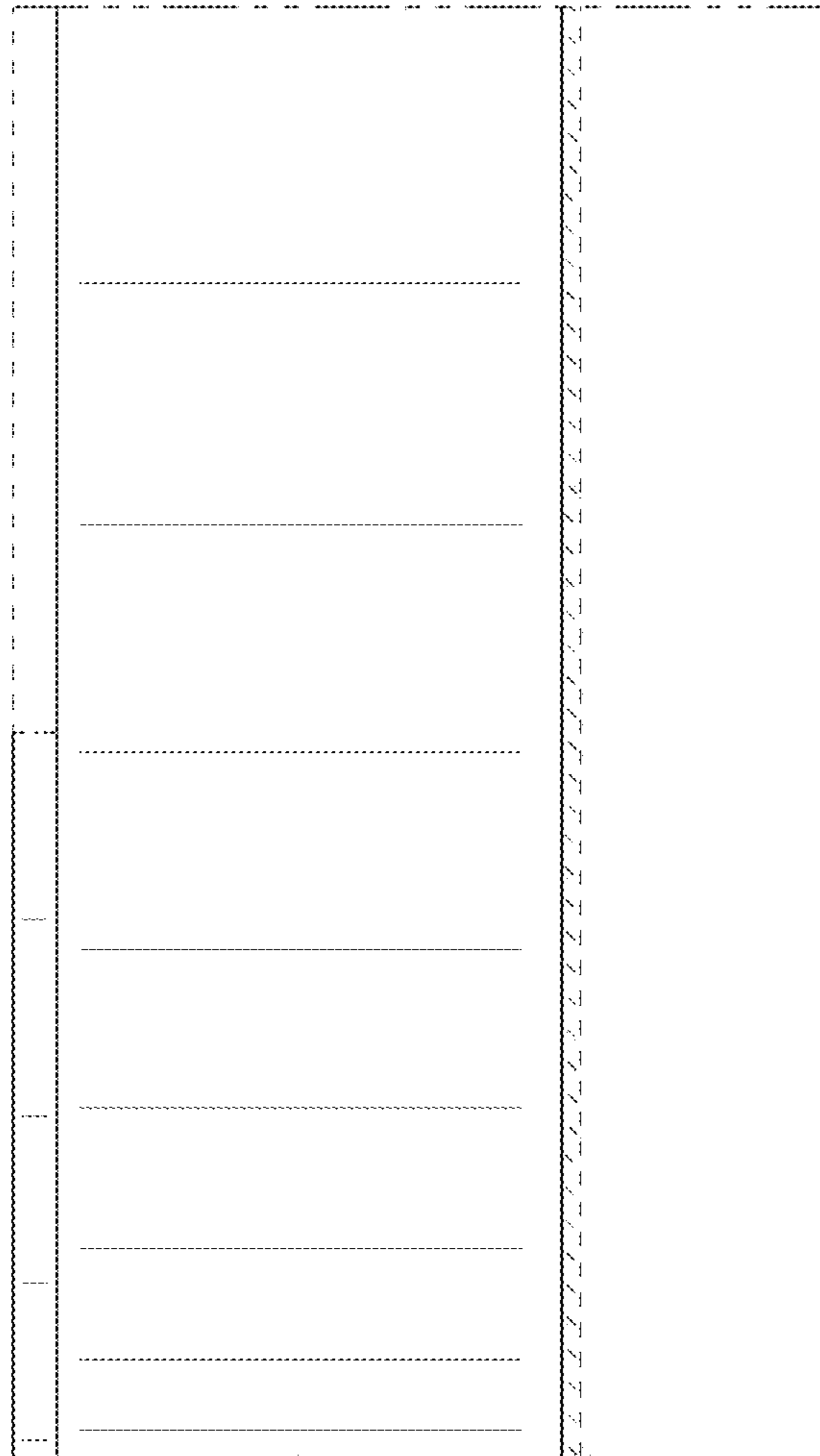

FIG. 16

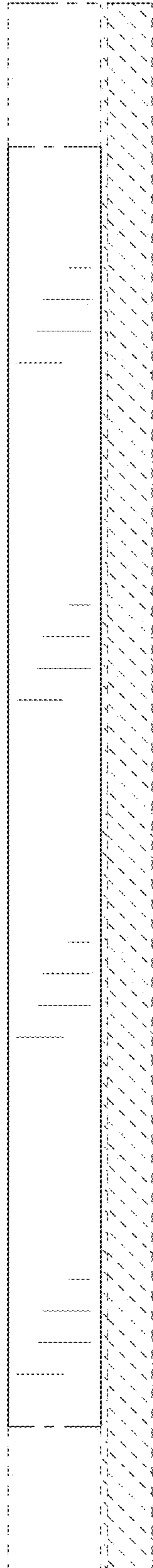

FIG. 17