



US00D895807S

(12) **United States Design Patent** (10) **Patent No.:** **US D895,807 S**
Berkely (45) **Date of Patent:** **** Sep. 8, 2020**

(54) **DENTAL AIR/WATER SYRINGE**

FOREIGN PATENT DOCUMENTS

(71) Applicant: **Donovan Winston Berkely**, Irvine, CA (US)

WO WO 00/35370 6/2000
WO WO 2000/33762 6/2000

(Continued)

(72) Inventor: **Donovan Winston Berkely**, Irvine, CA (US)

OTHER PUBLICATIONS

(**) Term: **15 Years**

Luzzani Dental, Mini Mate, dated at least Feb. 25, 2016, in 1 page.
(Continued)

(21) Appl. No.: **29/676,521**

Primary Examiner — Wan Laymon

(22) Filed: **Jan. 11, 2019**

(74) *Attorney, Agent, or Firm* — Knobbe, Martens, Olson & Bear, LLP

(57) **CLAIM**

The ornamental design for a dental air/water syringe, as shown and described.

Related U.S. Application Data

DESCRIPTION

(60) Division of application No. 29/564,574, filed on May 13, 2016, now Pat. No. Des. 841,817, which is a continuation of application No. 29/564,424, filed on May 12, 2016, now Pat. No. Des. 842,480.

(51) **LOC (12) Cl.** **24-02**

(52) **U.S. Cl.**
USPC **D24/176**

(58) **Field of Classification Search**
USPC D24/176–182, 152, 108, 112–114, 127;
433/80, 84–85, 88–89
CPC . A61C 17/0217; A61C 17/0202; A61C 17/00;
A61C 17/02; A61C 17/0211; A61C
17/0214; A61C 17/022; A61C 1/0061;
A61C 1/0076; A61C 1/052
See application file for complete search history.

FIG. 1 is a perspective view of a dental air/water syringe showing a first embodiment;
FIG. 2 is a left-side elevation view thereof;
FIG. 3 is a right-side elevation view thereof;
FIG. 4 is a front elevation view thereof;
FIG. 5 is a rear elevation view thereof;
FIG. 6 is a top plan view thereof; and
FIG. 7 is a bottom plan view thereof.
FIG. 8 is a perspective view of a dental air/water syringe showing a second embodiment;
FIG. 9 is a left-side elevation view thereof;
FIG. 10 is a right-side elevation view thereof;
FIG. 11 is a front elevation view thereof;
FIG. 12 is a rear elevation view thereof;
FIG. 13 is a top plan view thereof; and
FIG. 14 is a bottom plan view thereof.

All features in phantom line are for the purpose of illustrating environmental structure and form no part of the claimed subject matter. Color and texture may or may not form part of the claimed design or designs without departing from the design disclosed.

(56) **References Cited**

U.S. PATENT DOCUMENTS

1,858,056 A 5/1932 Pieper
2,094,888 A 10/1937 Hooper
3,121,426 A 2/1964 Yoshida
3,254,646 A 6/1966 Martin et al.

(Continued)

1 Claim, 6 Drawing Sheets

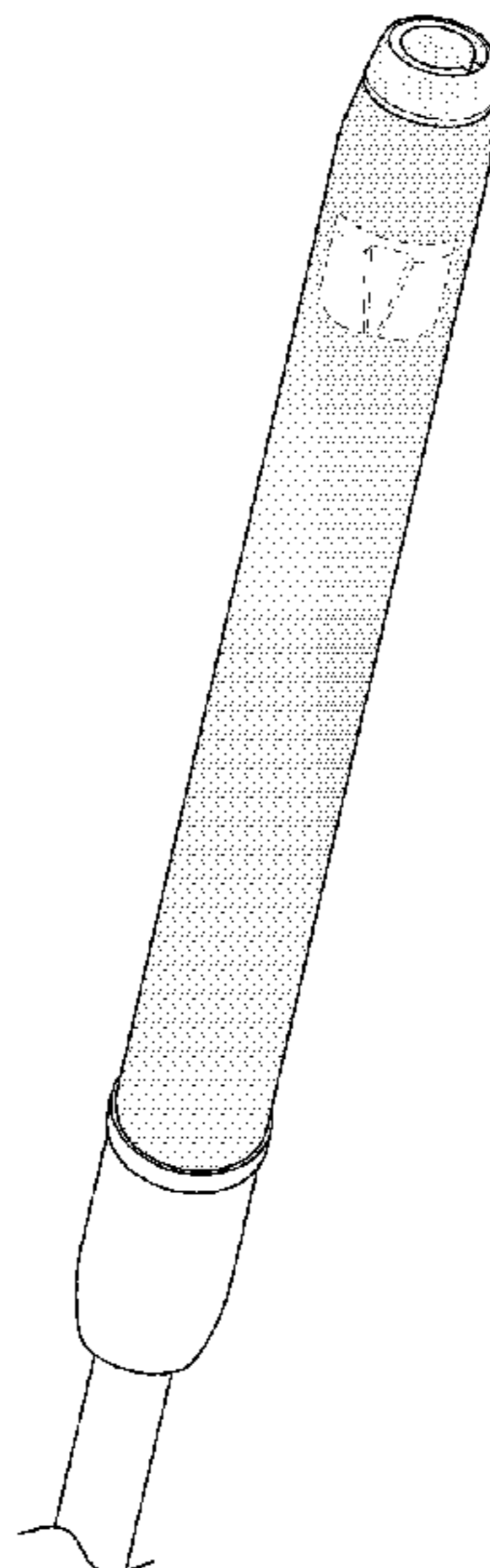

(56)

References Cited

U.S. PATENT DOCUMENTS

3,375,823 A 4/1968 Pamplin
 3,424,156 A 1/1969 Smith
 3,698,088 A 10/1972 Austin, Jr.
 3,874,083 A 4/1975 Buckley
 4,026,025 A 5/1977 Hunt
 4,248,589 A 2/1981 Lewis
 4,515,564 A 5/1985 Lohn
 4,522,597 A 6/1985 Gallant
 4,592,728 A 6/1986 Davis
 4,810,194 A 3/1989 Snedden
 4,907,744 A 3/1990 Jousson
 4,975,058 A 12/1990 Woodward
 D316,600 S 4/1991 Austin, Jr. et al.
 5,045,055 A 9/1991 Gonser et al.
 5,049,071 A 9/1991 Davis et al.
 5,067,899 A * 11/1991 Paschal A61C 17/0202
 433/116
 5,100,319 A 3/1992 Baum
 5,192,206 A 3/1993 Davis et al.
 5,204,004 A 4/1993 Johnston et al.
 5,230,624 A 7/1993 Wolf et al.
 5,234,338 A 8/1993 Young
 5,236,356 A 8/1993 Davis et al.
 5,242,300 A 9/1993 Esrock
 5,254,103 A 10/1993 Heuillon
 5,286,065 A 2/1994 Austin et al.
 5,306,146 A 4/1994 Davis et al.
 5,322,440 A 6/1994 Steele
 5,336,202 A 8/1994 Bailly et al.
 5,342,195 A 8/1994 Davis et al.
 D352,354 S 11/1994 Davis et al.
 5,376,003 A 12/1994 Rizkalla
 5,391,145 A 2/1995 Dorsey, III
 5,460,619 A 10/1995 Esrock
 5,468,148 A 11/1995 Ricks
 5,489,205 A 2/1996 Davis et al.
 5,554,025 A 9/1996 Kinsel
 5,591,389 A 1/1997 Esrock
 5,616,028 A 4/1997 Hafele et al.
 5,658,144 A 8/1997 Tinder et al.
 5,772,433 A 6/1998 Esrock
 5,833,456 A 11/1998 Davis et al.
 5,848,893 A 12/1998 Martin et al.
 5,882,194 A 3/1999 Davis et al.
 5,882,197 A 3/1999 Davis et al.
 D409,305 S 5/1999 Martin et al.
 5,899,692 A 5/1999 Davis et al.
 5,908,296 A 6/1999 Kipke et al.
 5,927,975 A 7/1999 Esrock
 5,961,326 A 10/1999 Johnston et al.
 6,048,200 A 4/2000 Martin et al.
 6,079,979 A 6/2000 Riitano
 6,093,020 A 7/2000 Pond et al.
 6,113,391 A 9/2000 Esrock
 6,149,429 A 11/2000 Bukowski et al.
 6,159,007 A 12/2000 Sorensen
 6,238,211 B1 5/2001 Esrock
 6,250,921 B1 6/2001 Esrock

RE37,324 E 8/2001 Esrock
 6,283,750 B1 9/2001 Esrock
 6,319,001 B1 11/2001 Esrock
 6,322,361 B1 11/2001 Esrock
 6,382,970 B1 5/2002 Foster
 6,390,815 B1 5/2002 Pond
 6,419,485 B1 7/2002 Pond
 6,464,498 B1 10/2002 Pond
 6,500,000 B1 12/2002 Segal
 6,533,578 B2 3/2003 Segal
 6,824,385 B1 11/2004 Bain et al.
 7,025,755 B2 4/2006 Epstein
 7,431,587 B2 10/2008 Pond
 7,993,135 B2 8/2011 Nesbitt et al.
 8,662,470 B2 3/2014 Klecker et al.
 8,926,502 B2 1/2015 Levy et al.
 9,993,142 B2 6/2018 Salman et al.
 D832,443 S 10/2018 Berkely
 D832,444 S 10/2018 Berkely
 D841,817 S 2/2019 Berkely
 D842,480 S 3/2019 Berkely
 D875,257 S 2/2020 Berkely
 D875,258 S 2/2020 Berkely
 2001/0041321 A1 11/2001 Segal
 2004/0224281 A1 11/2004 Bain et al.
 2005/0032017 A1 2/2005 Levy
 2005/0089816 A1 4/2005 Krisch
 2006/0024640 A1 2/2006 Pond et al.
 2006/0063976 A1 3/2006 Alzenfeld et al.
 2006/0234185 A1 10/2006 Ziemba
 2007/0106119 A1 5/2007 Hirata et al.
 2008/0002402 A1 1/2008 Mandikos
 2009/0202961 A1 8/2009 Fani et al.
 2010/0273123 A1 10/2010 Mecher
 2010/0286659 A1 11/2010 Terrill et al.
 2010/0298640 A1 11/2010 Oneda et al.
 2011/0143304 A1 6/2011 Jamnia et al.
 2011/0275026 A1 11/2011 Smith
 2012/0253121 A1 10/2012 Kitano
 2013/0109916 A1 5/2013 Levy
 2013/0172670 A1 7/2013 Levy et al.
 2013/0260333 A1 10/2013 Berkely
 2013/0316299 A1 11/2013 Berkely
 2014/0329198 A1 11/2014 Esrock
 2015/0024335 A1 1/2015 Sabourin
 2015/0050613 A1 2/2015 Berkely
 2015/0209124 A1 7/2015 Berkely
 2018/0214245 A1* 8/2018 Medin A61C 17/0217
 2019/0105140 A1 4/2019 Berkely

FOREIGN PATENT DOCUMENTS

WO WO 2013/151961 10/2013
 WO WO 2015/023799 2/2015

OTHER PUBLICATIONS

Luzzani Dental, Mini Light, dated at least Feb. 25, 2016, in 1 page.

* cited by examiner

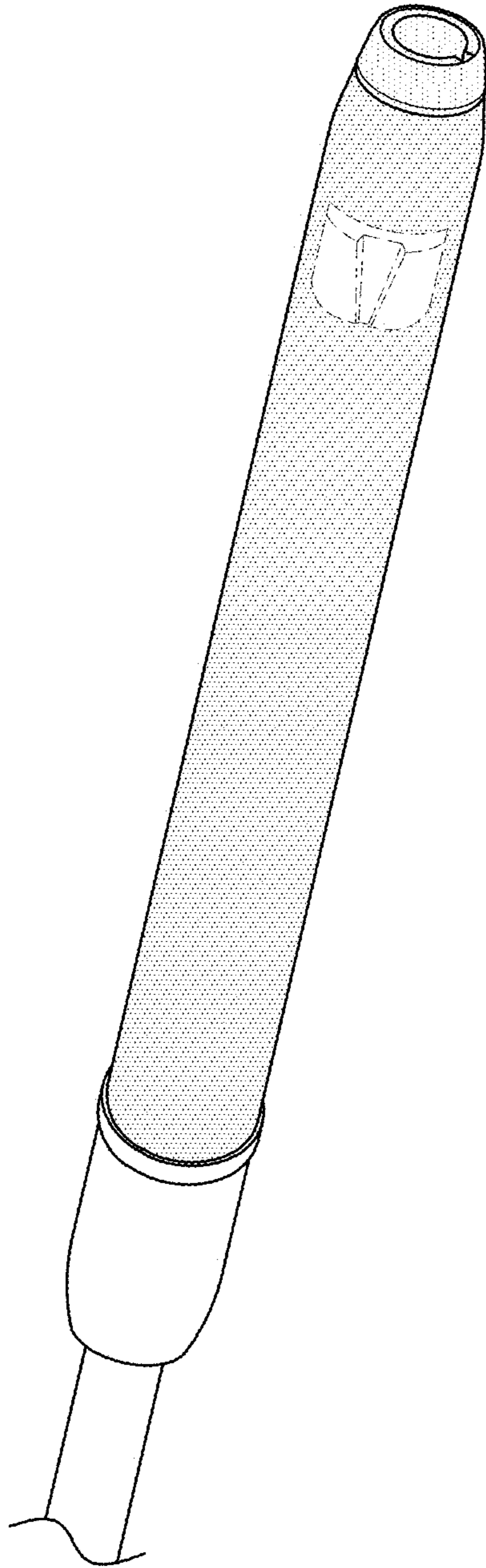

FIG. 1

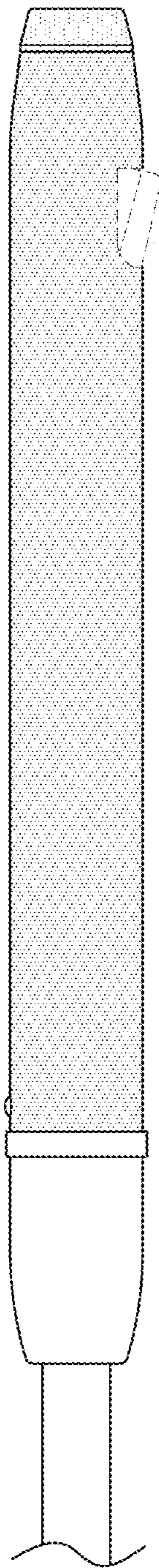

FIG. 2

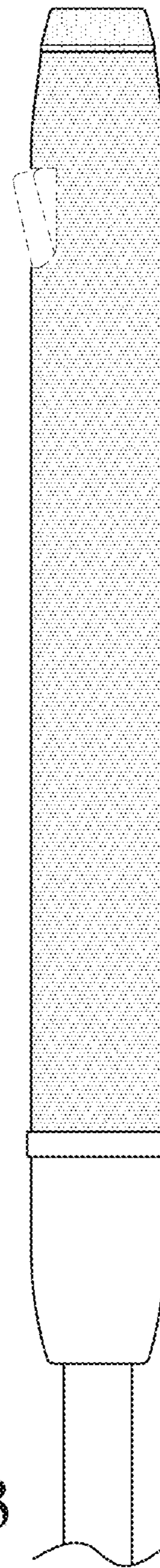

FIG. 3

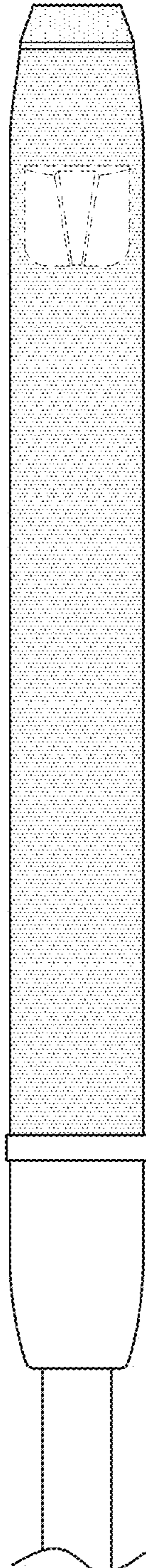

FIG. 6

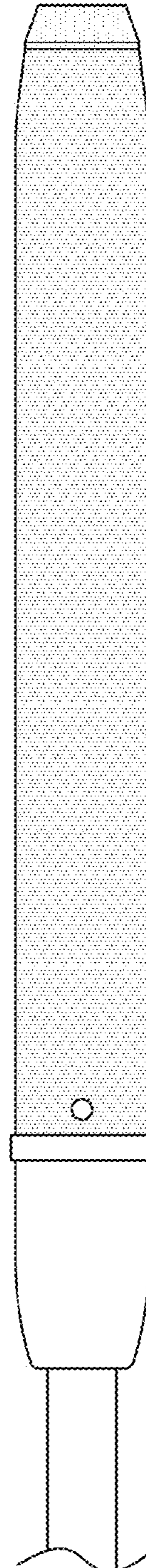

FIG. 7

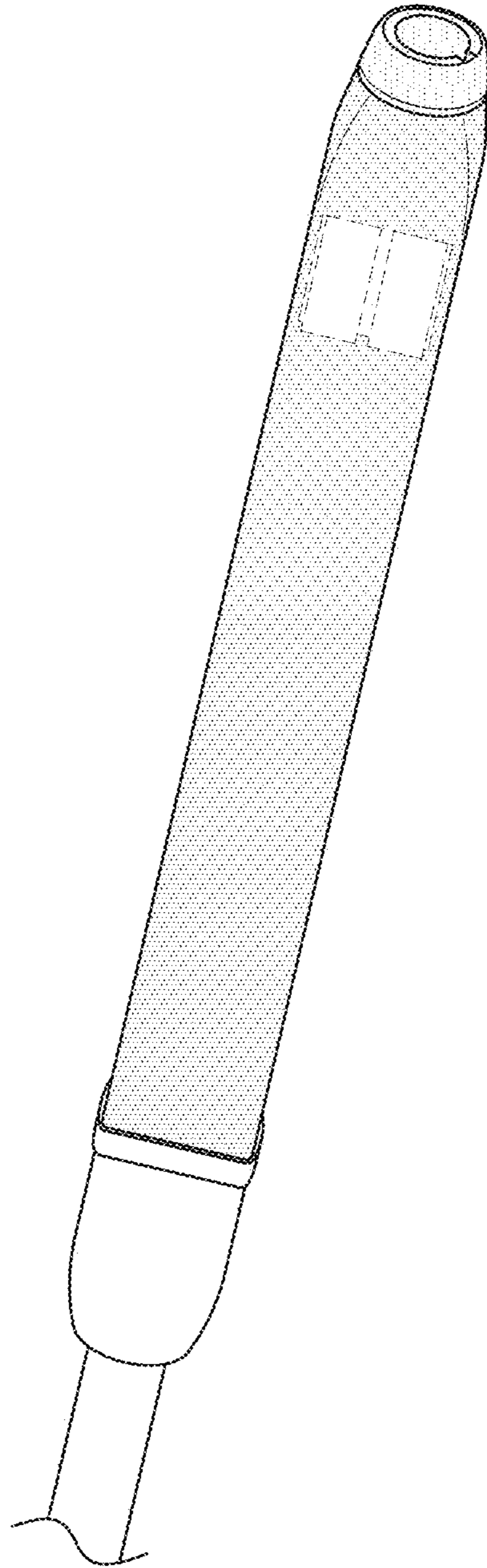

FIG. 8

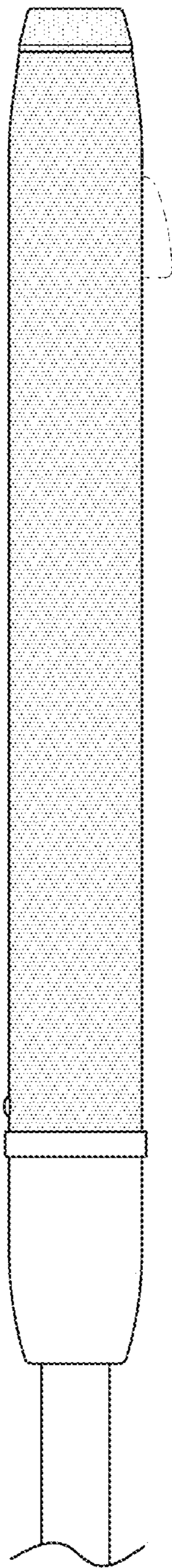

FIG. 9

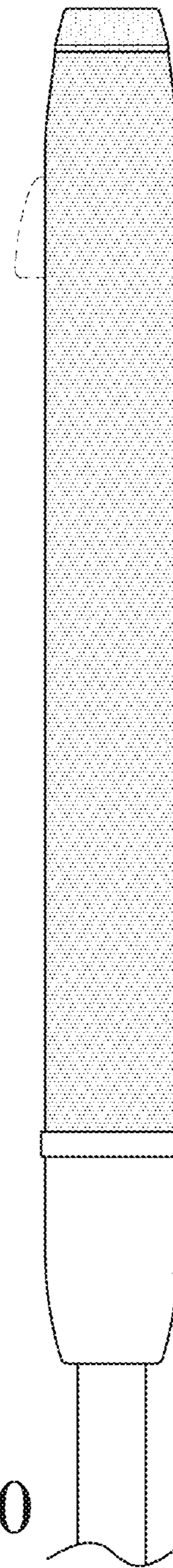

FIG. 10

FIG. 11

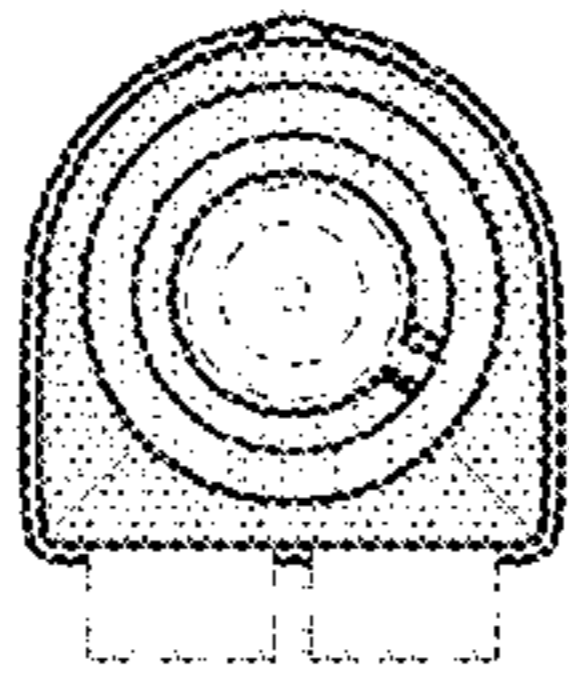

FIG. 12

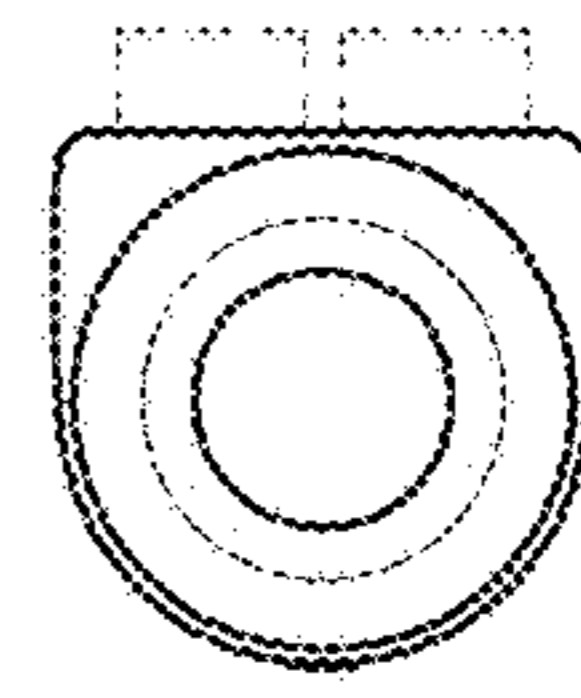

FIG. 13

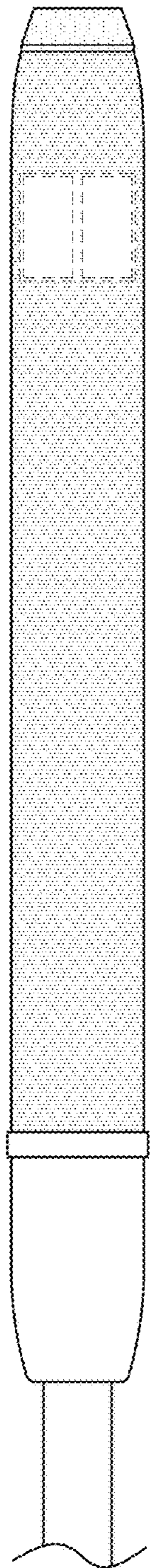

FIG. 14

