



US00D895806S

(12) **United States Design Patent**
Zheng

(10) **Patent No.:** **US D895,806 S**

(45) **Date of Patent:** **** Sep. 8, 2020**

(54) **HEARING AID**

(71) Applicant: **Weifeng Zheng**, Shenzhen (CN)

(72) Inventor: **Weifeng Zheng**, Shenzhen (CN)

(**) Term: **15 Years**

(21) Appl. No.: **29/686,957**

(22) Filed: **Apr. 9, 2019**

(51) **LOC (12) Cl.** **24-99**

(52) **U.S. Cl.**
USPC **D24/174**

(58) **Field of Classification Search**
USPC D24/173-175; D14/205, 223-226, 249,
D14/230, 231, 236
CPC .. H04R 2225/025; H04R 25/60; H04R 25/63;
H04R 25/67; H04R 25/602; H04R
25/604; H04R 25/608; H04R 25/65;
H04R 25/652

See application file for complete search history.

(56) **References Cited**

U.S. PATENT DOCUMENTS

D297,979 S * 10/1988 Voroba D24/174
D397,796 S * 9/1998 Yabe D24/174

D554,756 S * 11/2007 Sjursen D24/174
D635,676 S * 4/2011 Voix D24/174
D636,492 S * 4/2011 Aquilina D24/174
D674,490 S * 1/2013 Bailey D24/174
D728,107 S * 4/2015 Torres Martin D24/174
D883,257 S * 5/2020 Duddy D14/205
2007/0177749 A1 * 8/2007 Sjursen H04R 25/602
381/323
2016/0353216 A1 * 12/2016 Ruzicka H04R 25/652

* cited by examiner

Primary Examiner — Anhdao Doan

(74) *Attorney, Agent, or Firm* — W&K IP

(57) **CLAIM**

The ornamental design for a hearing aid, as shown and described.

DESCRIPTION

FIG. 1 is a perspective view of a hearing aid;
FIG. 2 is a front elevational view thereof;
FIG. 3 is a rear elevational view thereof;
FIG. 4 is a left elevational view thereof;
FIG. 5 is a right elevational view thereof;
FIG. 6 is a top plan view thereof; and,
FIG. 7 is a bottom plan view thereof.

1 Claim, 7 Drawing Sheets

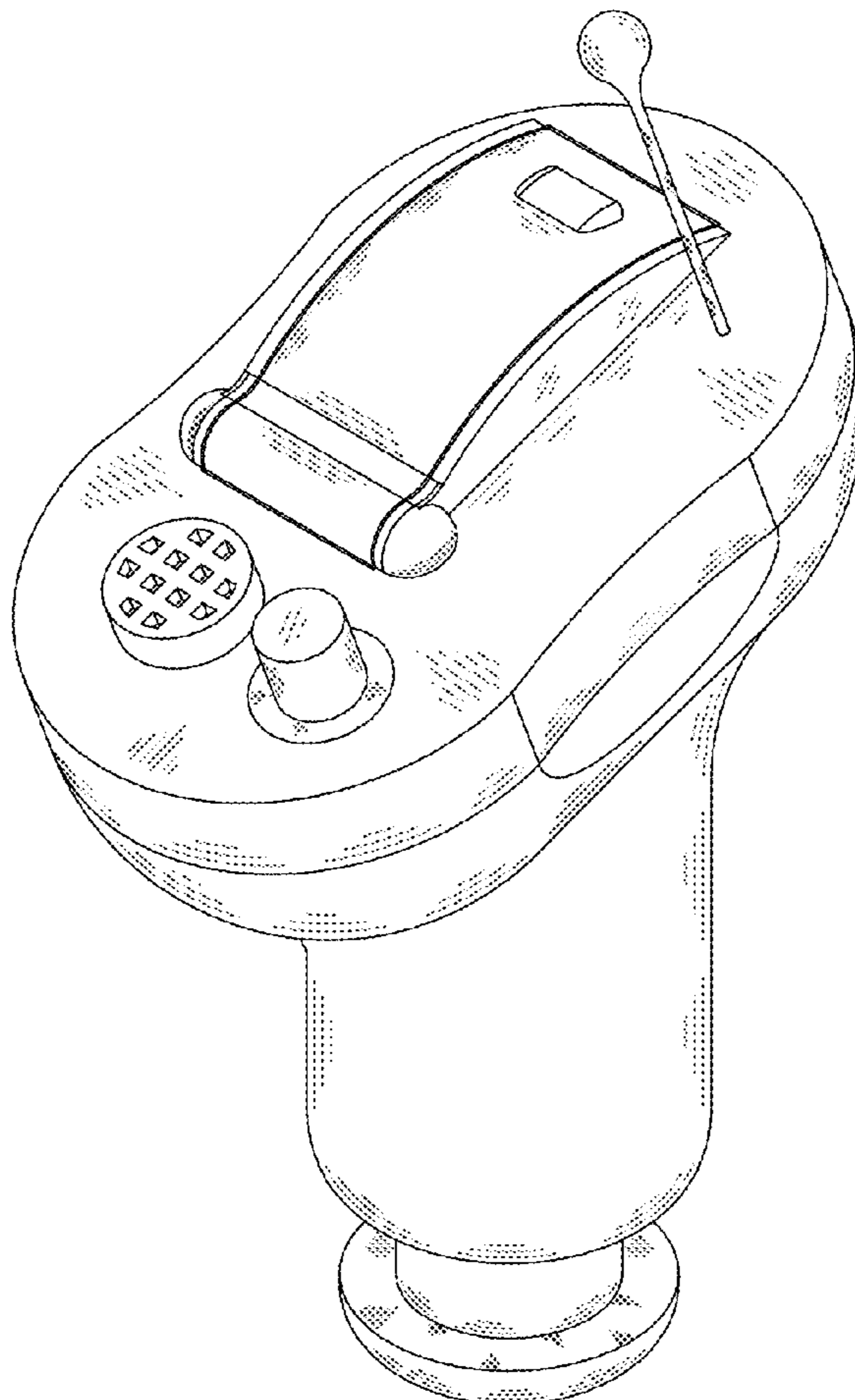

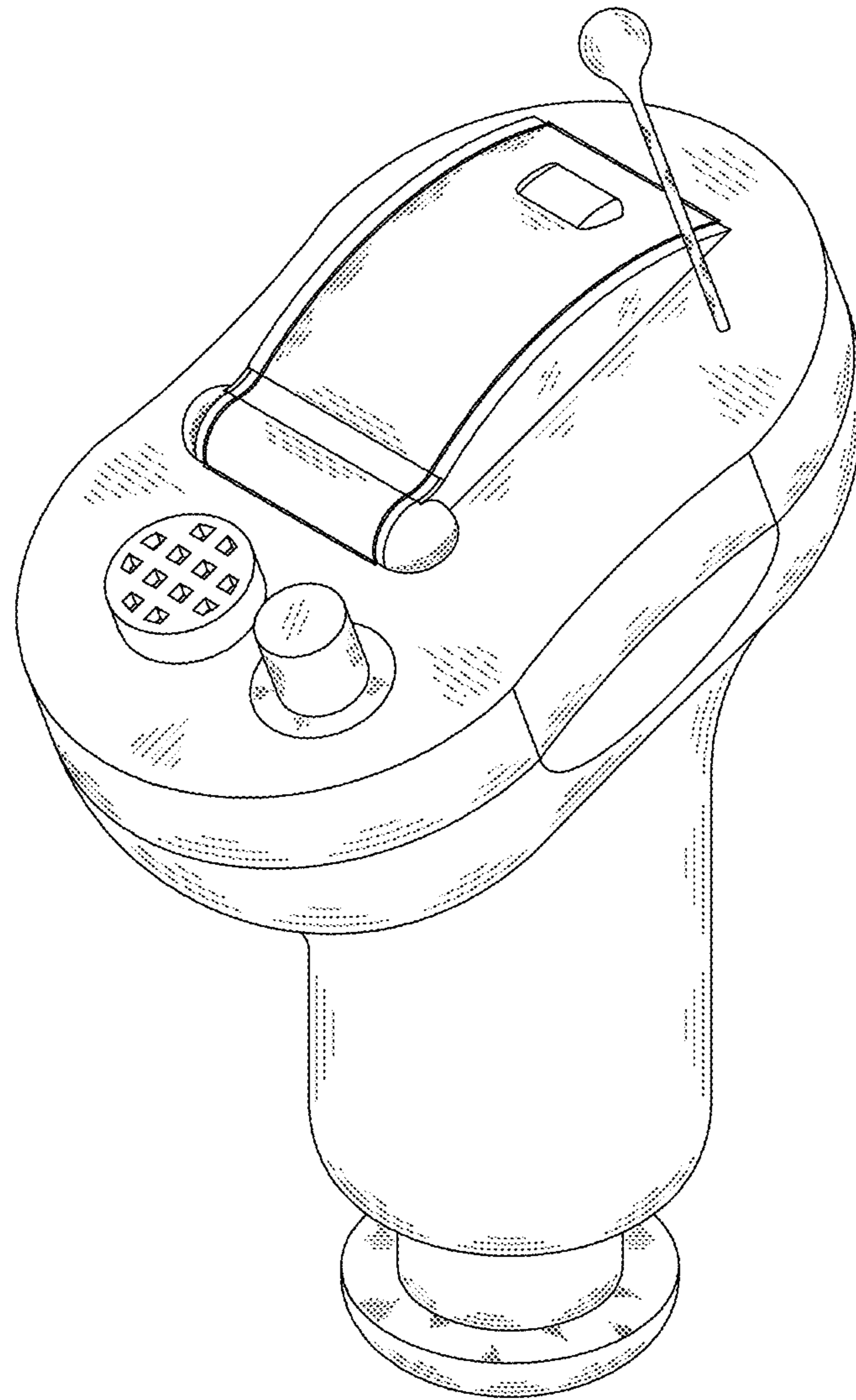

FIG.1

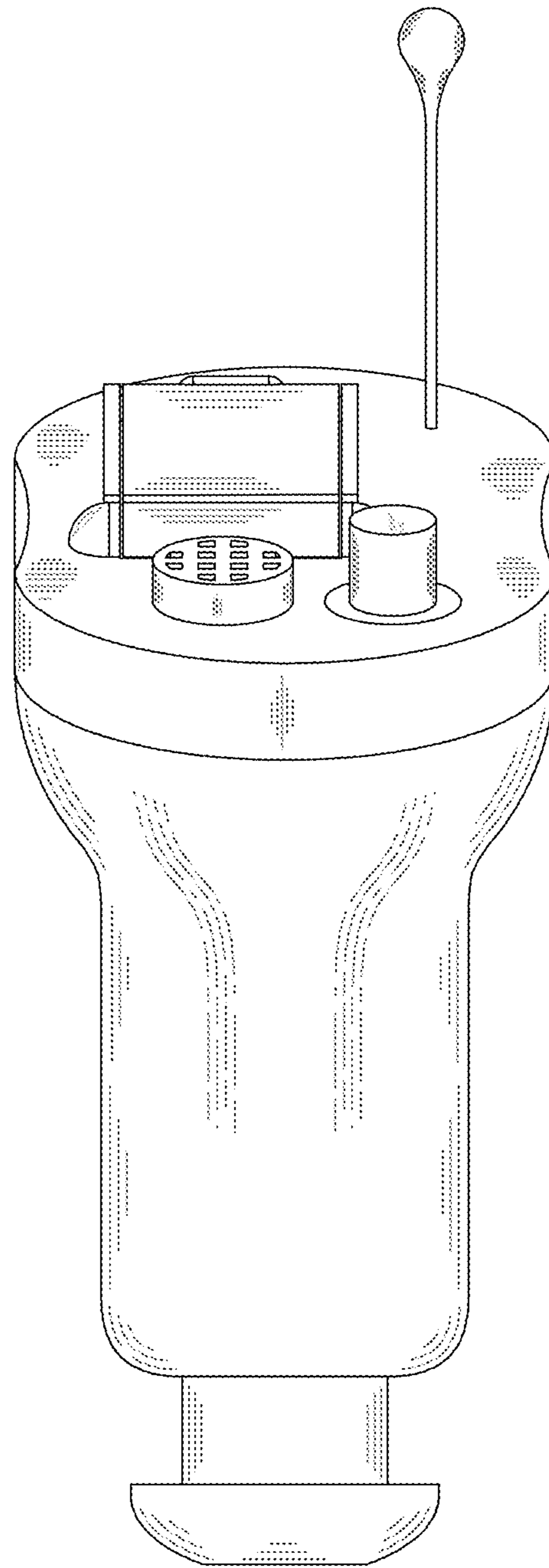

FIG.2

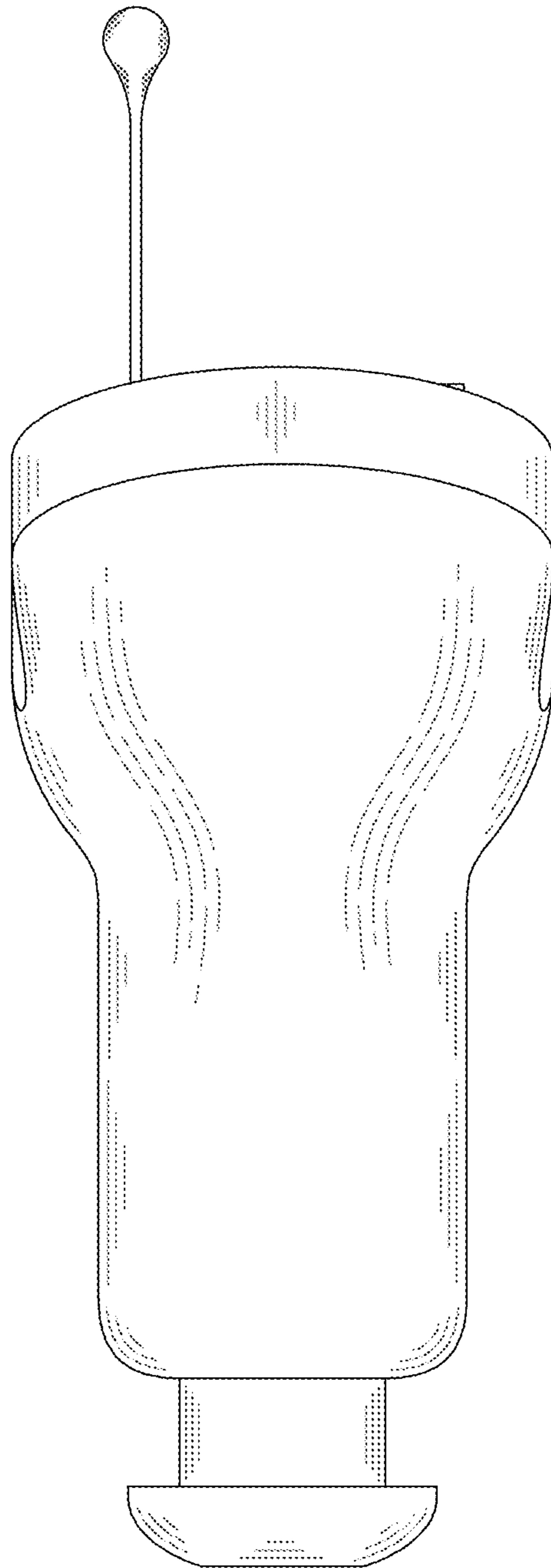

FIG.3

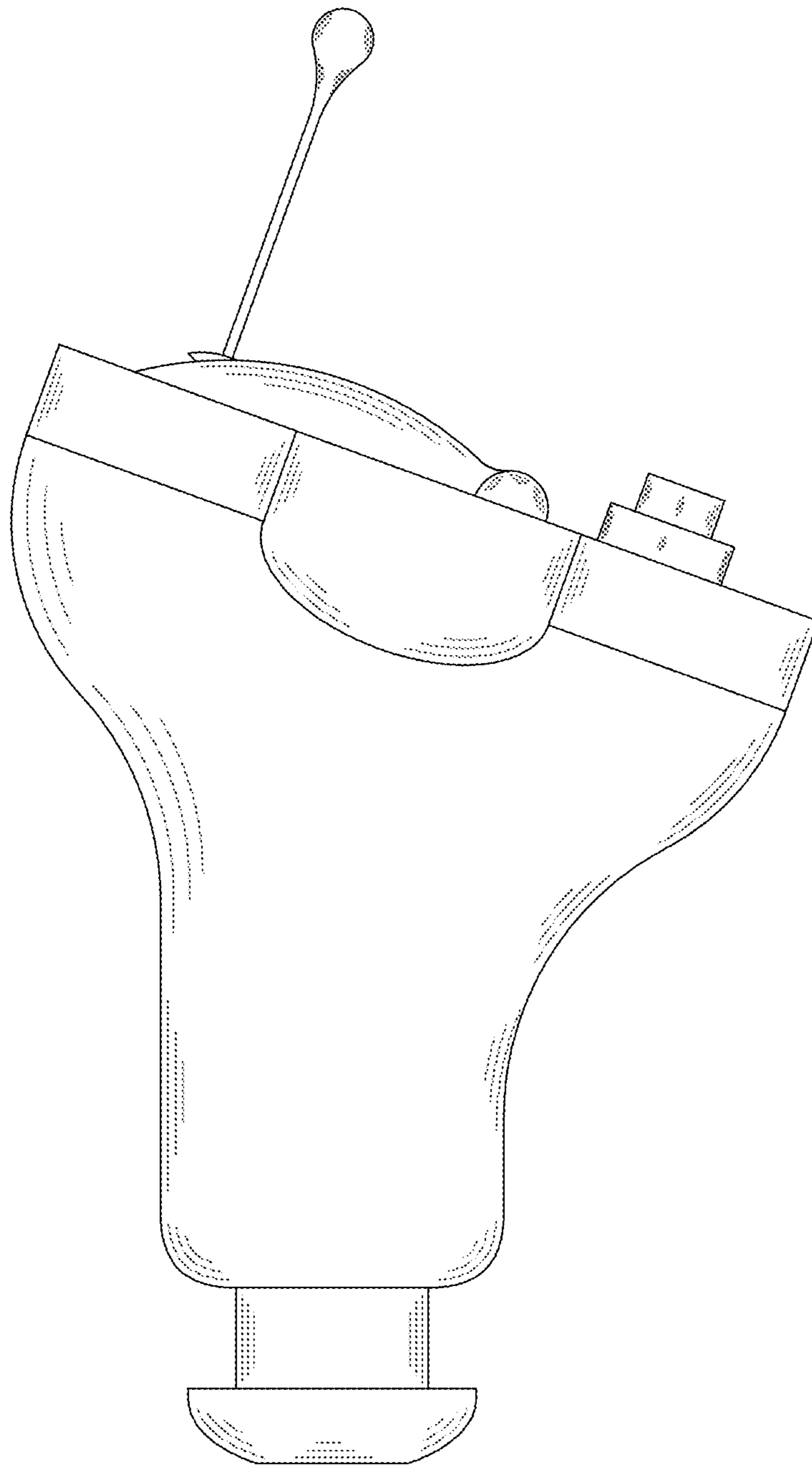

FIG.4

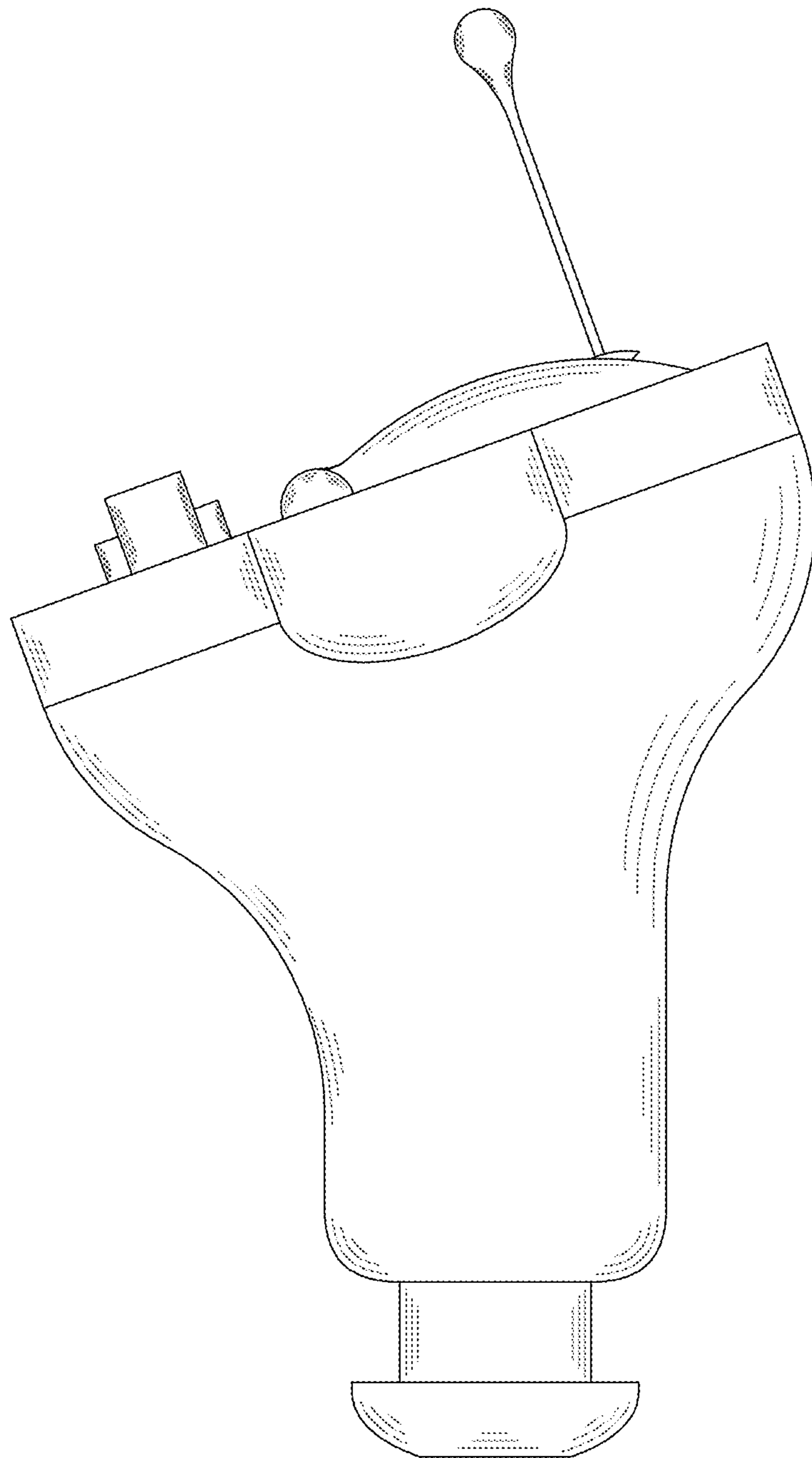

FIG.5

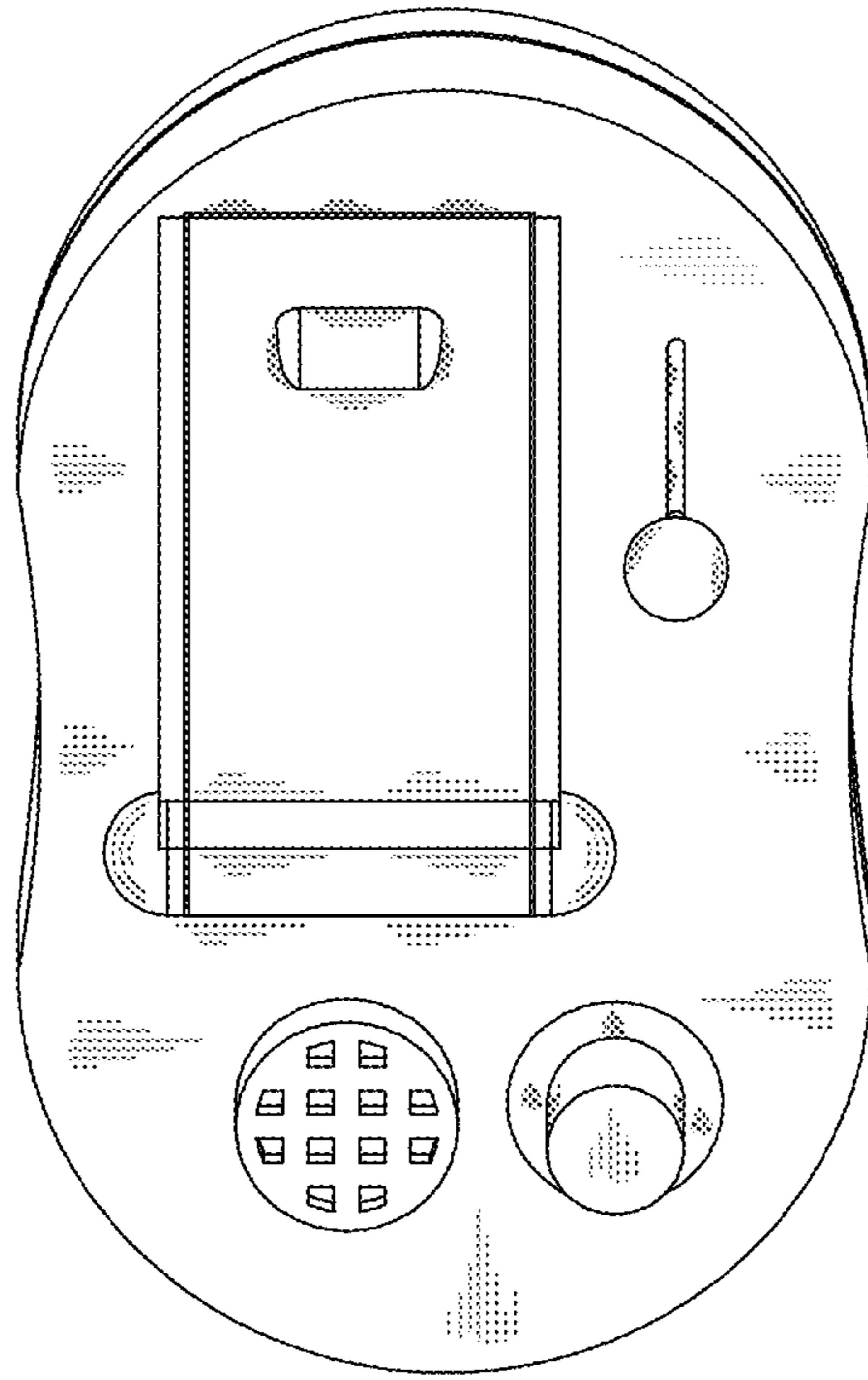

FIG.6

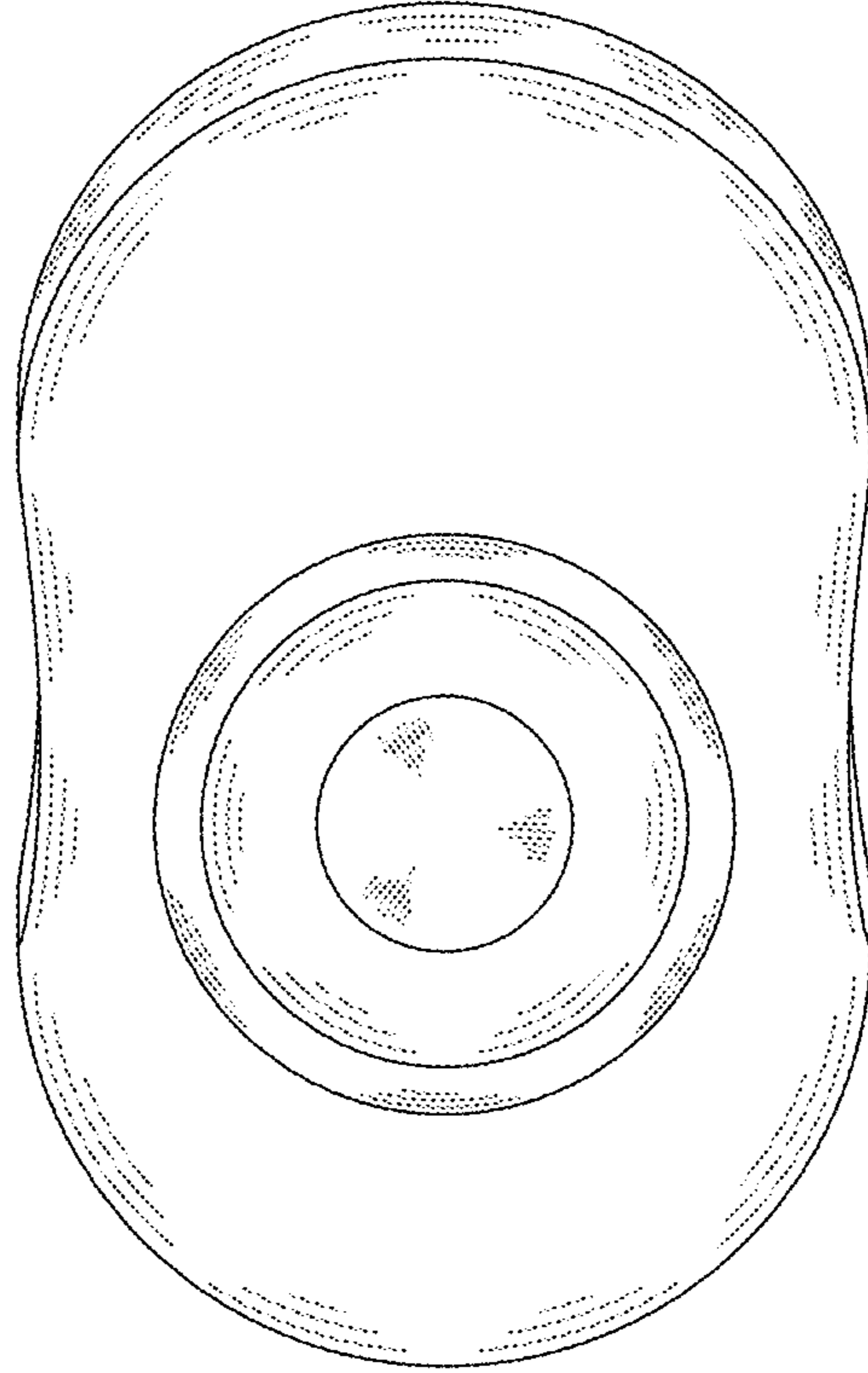

FIG.7