



US00D895782S

(12) **United States Design Patent**  
**Ying**

(10) **Patent No.:** **US D895,782 S**

(45) **Date of Patent:** **\*\* Sep. 8, 2020**

(54) **BLADELESS FAN**

(71) Applicant: **Hui Ying**, Zhejiang (CN)

(72) Inventor: **Hui Ying**, Zhejiang (CN)

(\*\*) Term: **15 Years**

(21) Appl. No.: **29/663,485**

(22) Filed: **Sep. 17, 2018**

(30) **Foreign Application Priority Data**

Aug. 30, 2018 (CN) ..... 2018 3 0486921

(51) **LOC (12) Cl.** ..... **23-04**

(52) **U.S. Cl.**  
USPC ..... **D23/378**

(58) **Field of Classification Search**  
USPC ..... D23/332–333, 336–337, 342, 364, 366,  
D23/370–376, 378, 385, 386  
CPC ..... F04D 5/00; F04D 27/00; F04D 25/088;  
F04D 29/005; F04D 29/601; F04D  
29/324; F24H 3/04; F21V 33/0096; F21V  
33/0092; F24F 13/078  
See application file for complete search history.

(56) **References Cited**

**U.S. PATENT DOCUMENTS**

D672,023 S *	12/2012	Wallace	.....	D23/332
D729,372 S *	5/2015	McPherson	.....	D23/370
D729,925 S *	5/2015	McPherson	.....	D23/370
D768,839 S *	10/2016	Peet	.....	D23/370
D783,141 S *	4/2017	Poulton	.....	D23/370
10,260,521 B2 *	4/2019	Barclay	.....	F04D 25/08
2016/0281742 A1 *	9/2016	Rivera	.....	F04D 29/601

**OTHER PUBLICATIONS**

Bladeless Fan, Application No. 201830145485, application date Apr. 11, 2018, date published Sep. 28, 2018, published in CN, site visited Sep. 28, 2019, available at www.orbit.com.\*

\* cited by examiner

*Primary Examiner* — Cathron C Brooks

*Assistant Examiner* — Sharon S Oum

(74) *Attorney, Agent, or Firm* — Prakash Nama; Global IP Services, PLLC

(57) **CLAIM**

The ornamental design for a bladeless fan, as shown and described.

**DESCRIPTION**

FIG. 1 is a front elevational view of a bladeless fan showing my new design;  
FIG. 2 is a rear elevational view thereof;  
FIG. 3 is a left side view thereof;  
FIG. 4 is a right side view thereof;  
FIG. 5 is a top plan view thereof;  
FIG. 6 is a bottom plan view thereof;  
FIG. 7 is an elevational view of the front and left sides thereof;  
FIG. 8 is an enlarged view of portion 8 shown in FIG. 1;  
FIG. 9 is an enlarged view of portion 9 shown in FIG. 2;  
FIG. 10 is an enlarged view of portion 10 shown in FIG. 3;  
FIG. 11 is an enlarged view of portion 11 shown in FIG. 4;  
FIG. 12 is an enlarged view of portion 12 shown in FIG. 7;  
and,  
FIG. 13 is an enlarged view of portion 13 shown in FIG. 7.  
The broken lines illustrate portions of the bladeless fan that form no part of the claimed design.

**1 Claim, 9 Drawing Sheets**

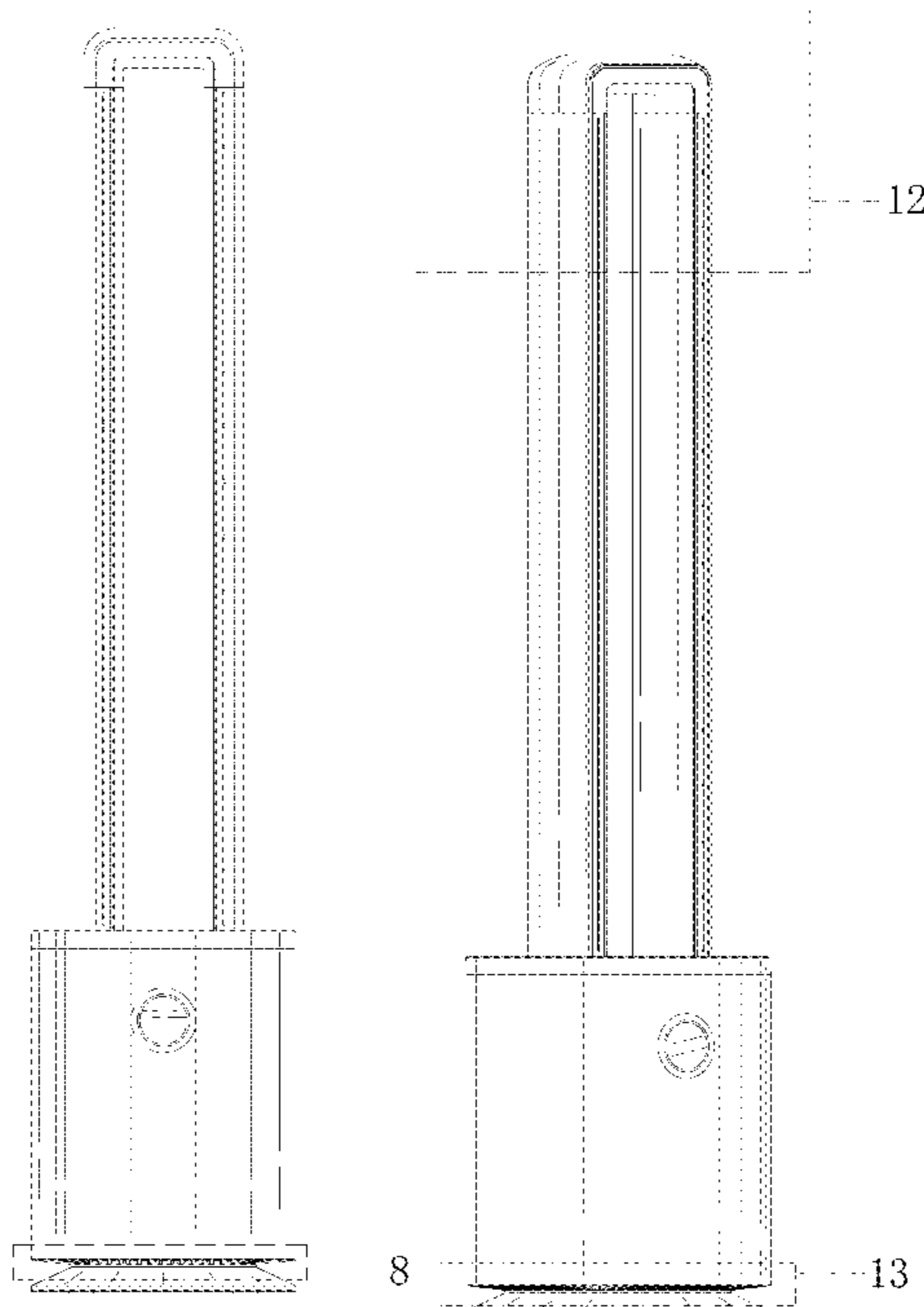

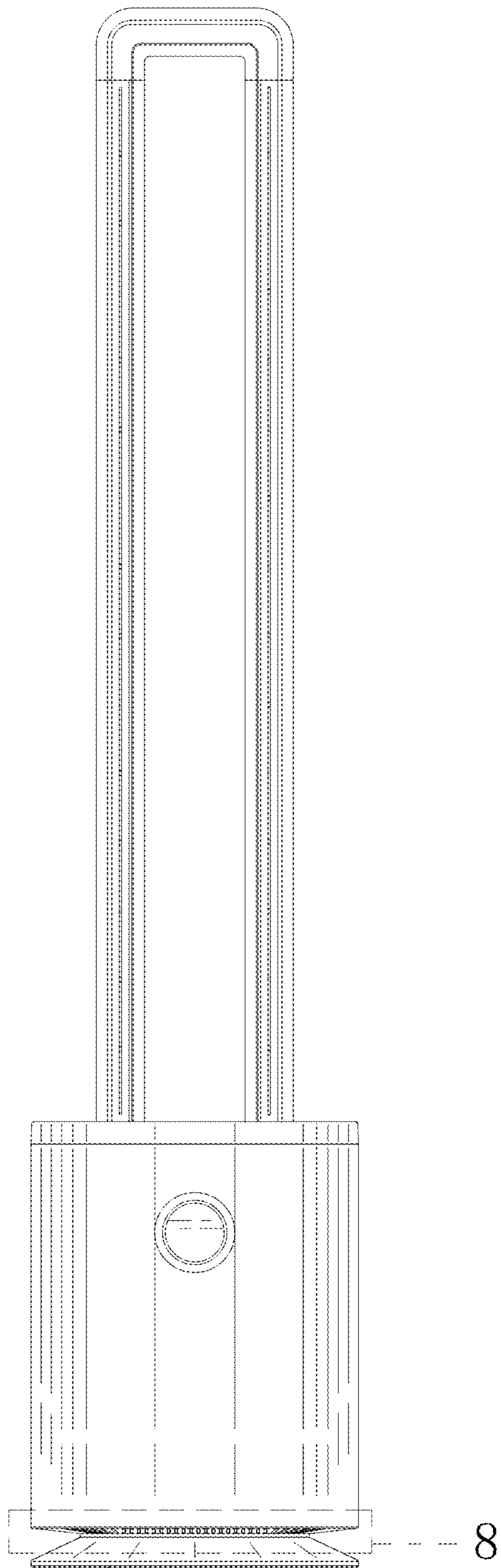

Fig. 1

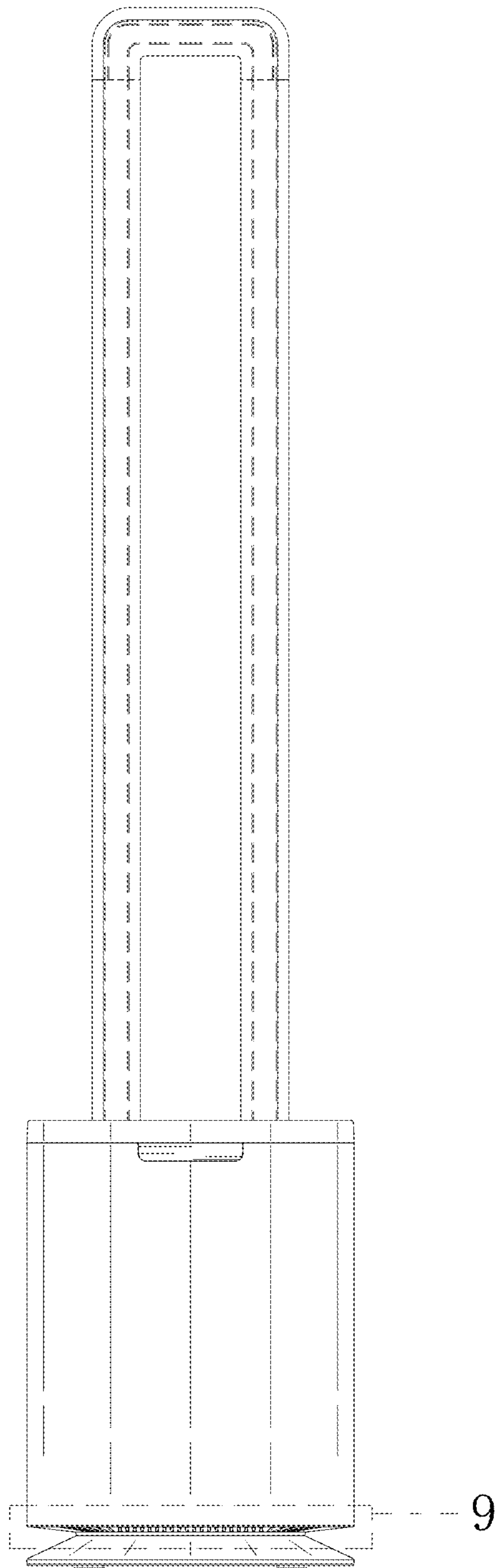

Fig. 2

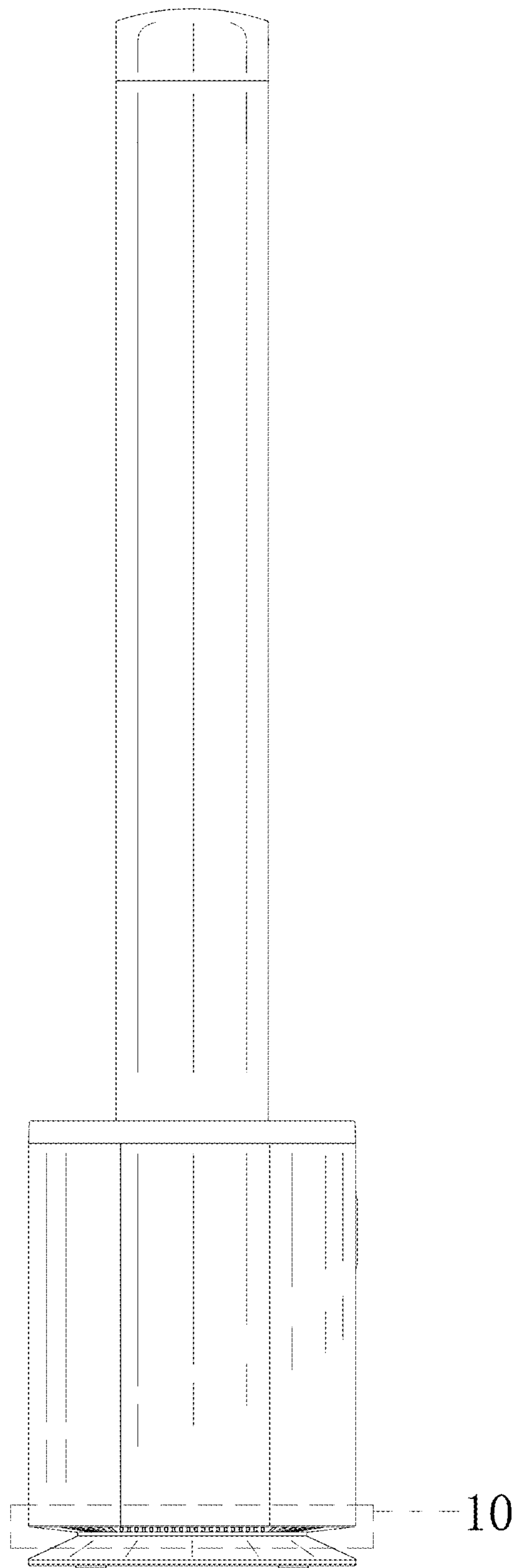

Fig. 3

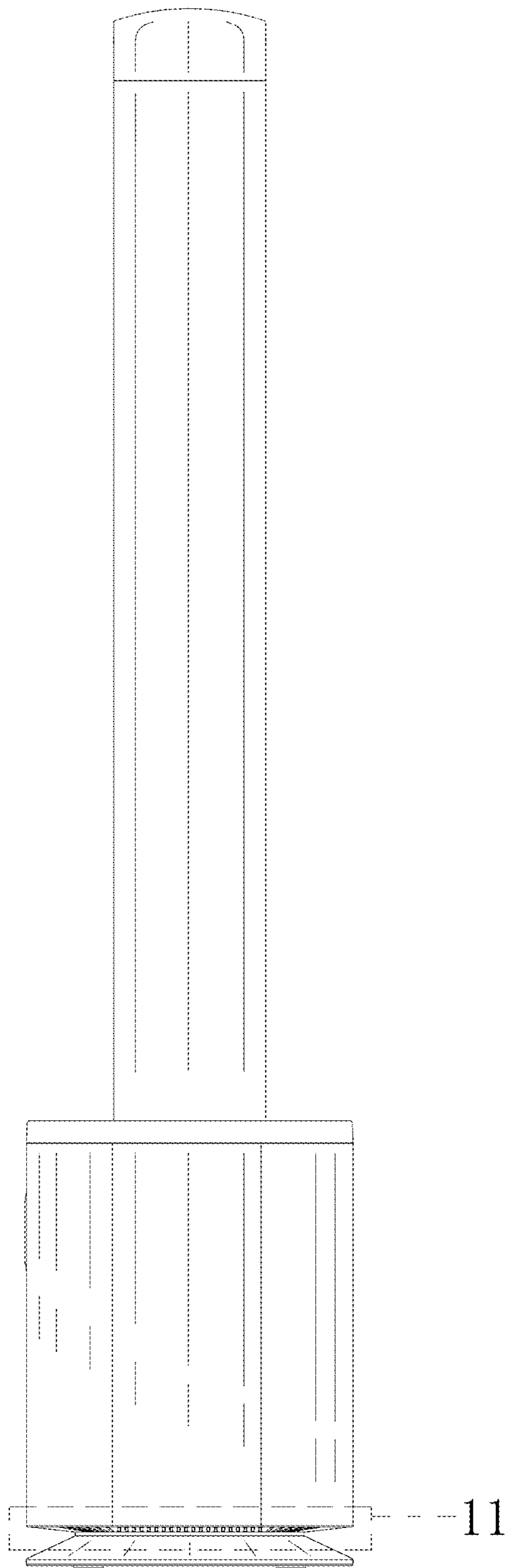

Fig. 4

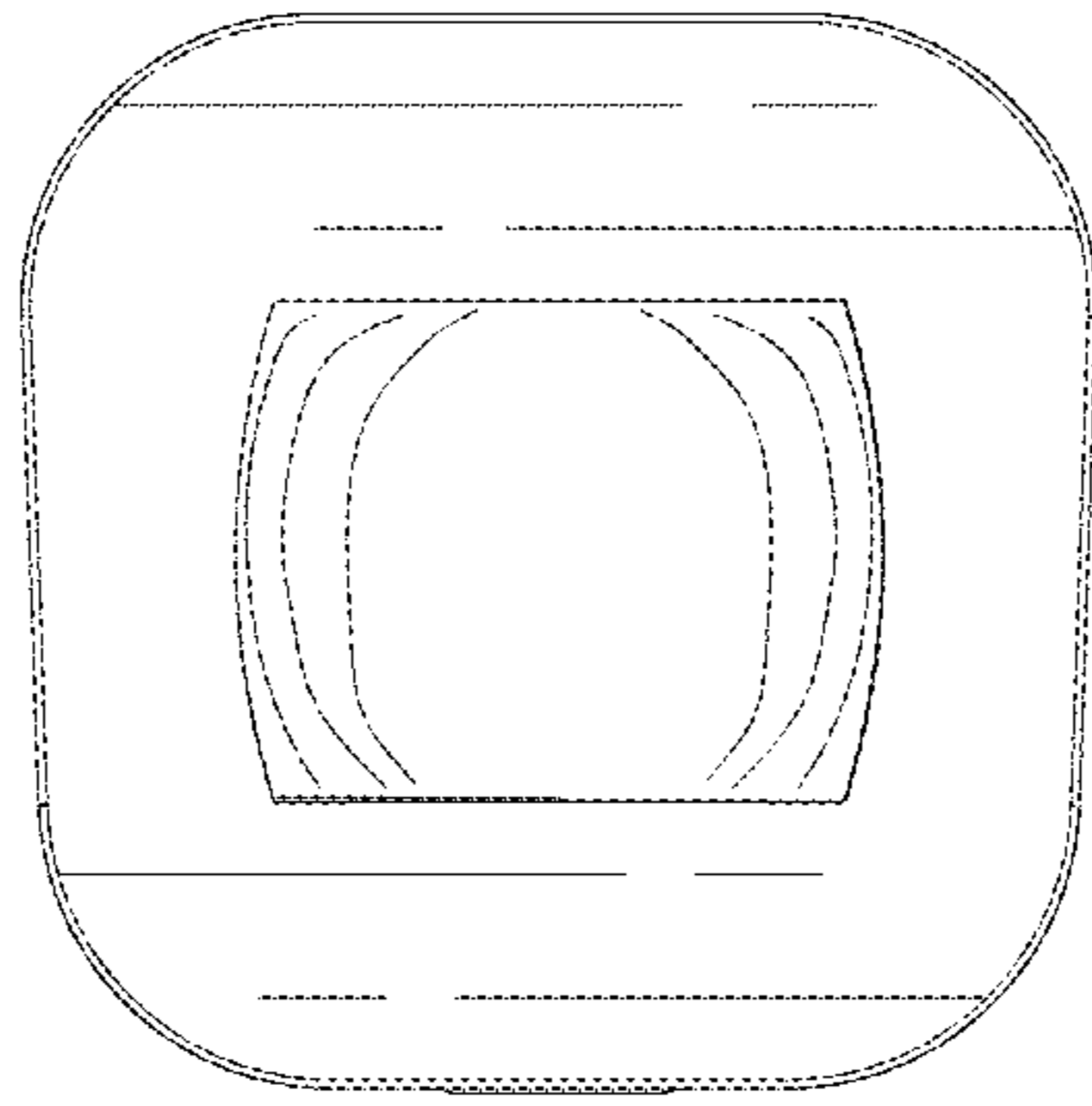

Fig. 5

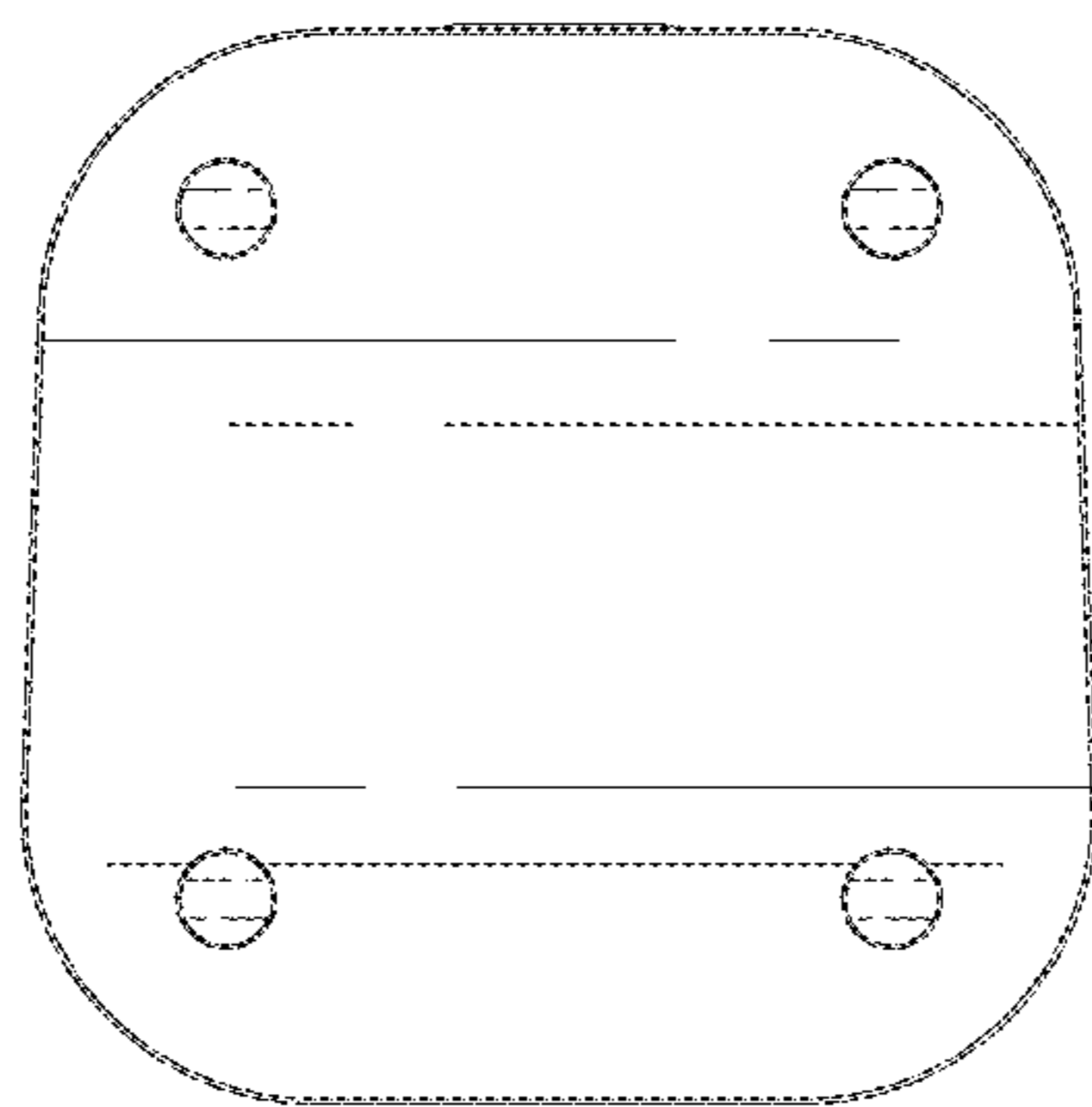

Fig. 6

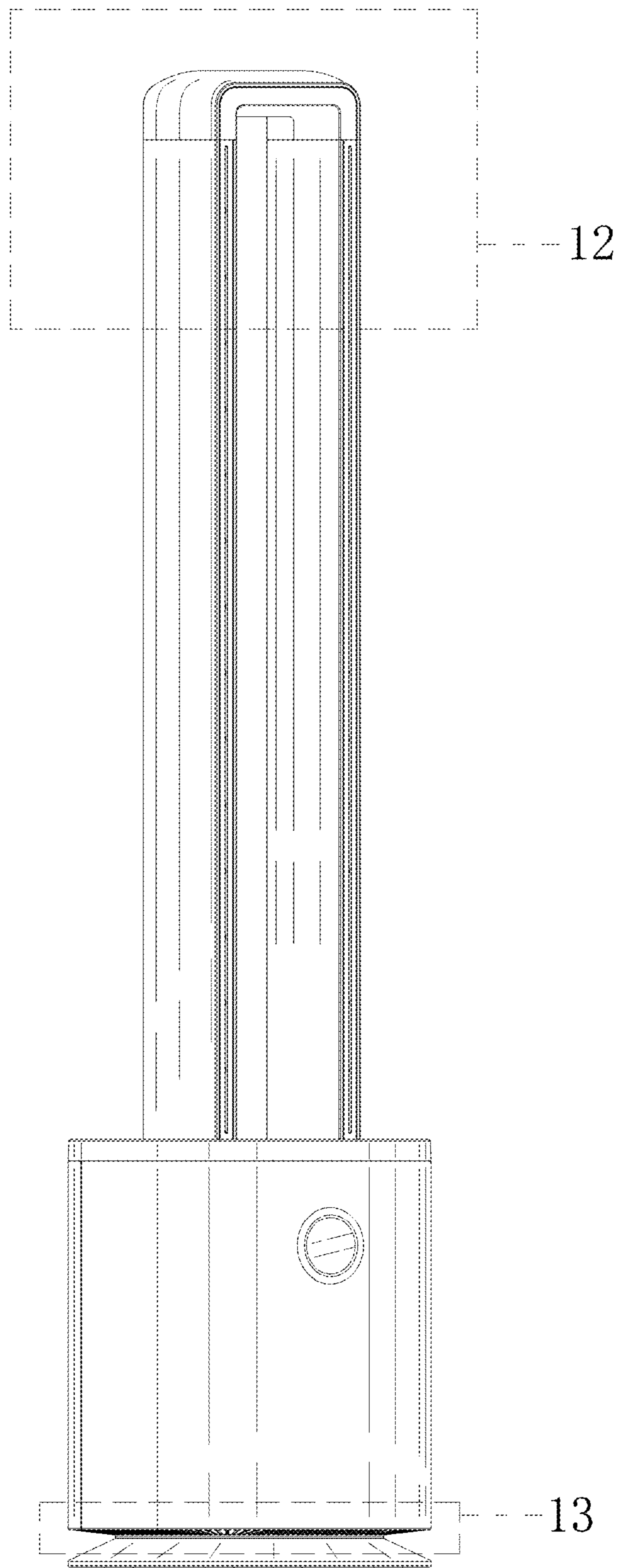

Fig. 7

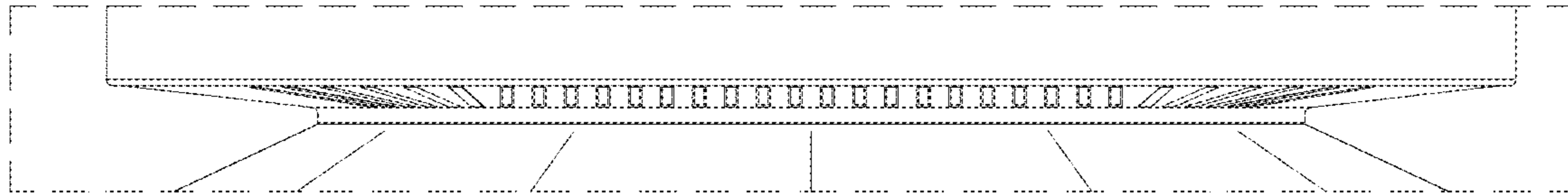

Fig. 8

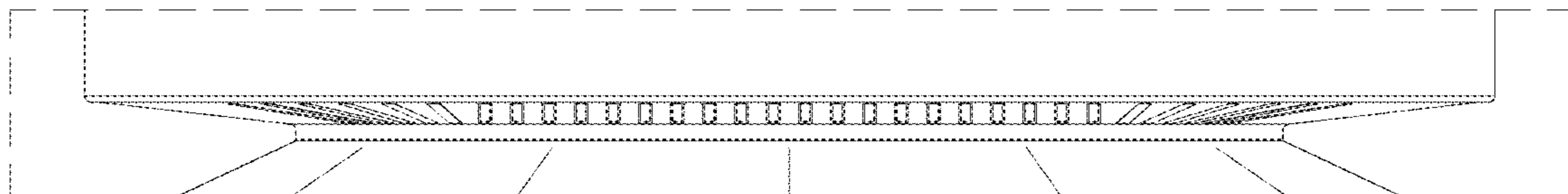

Fig. 9



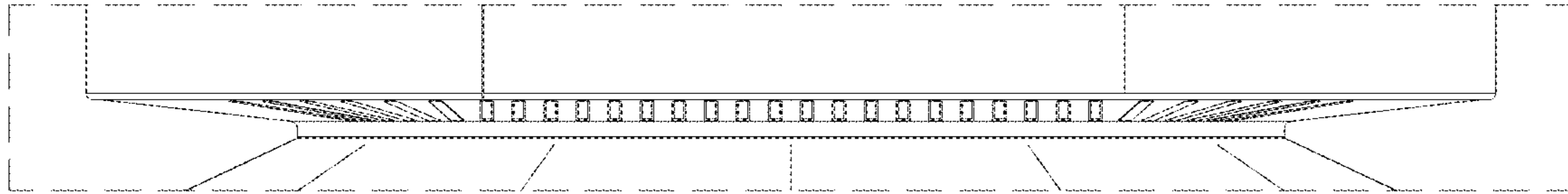

Fig. 10

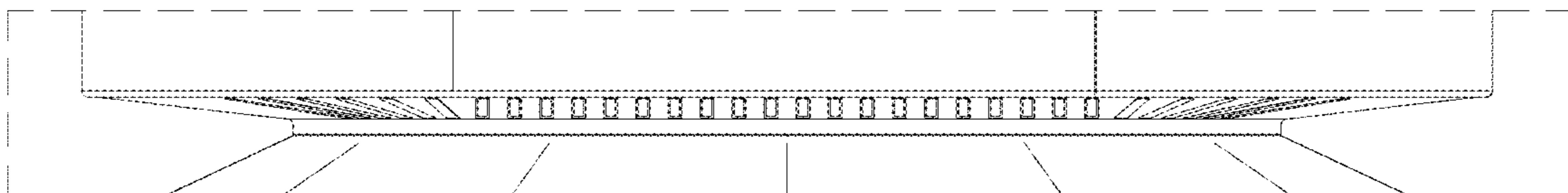

Fig. 11

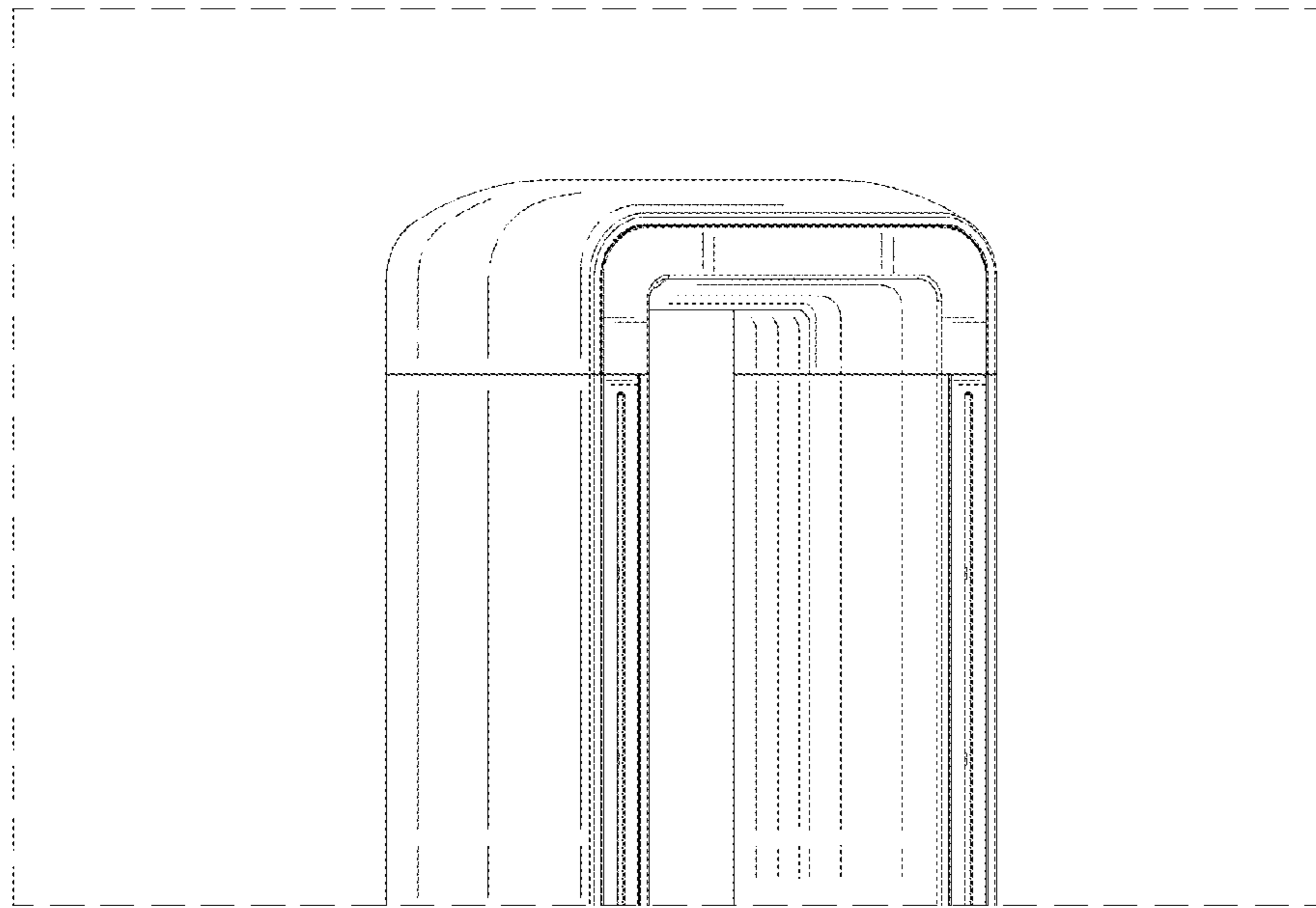

Fig. 12

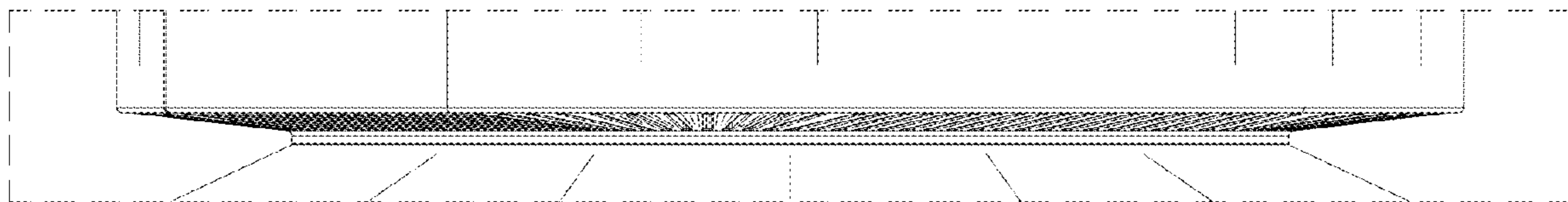

Fig. 13