



US00D895779S

(12) **United States Design Patent** (10) **Patent No.:** **US D895,779 S**
Bentancourt (45) **Date of Patent:** **** Sep. 8, 2020**

(54) **TOILET BOWL SAFETY SCREEN**
(71) Applicant: **Jesse Bentancourt**, Corpus Christi, TX (US)
(72) Inventor: **Jesse Bentancourt**, Corpus Christi, TX (US)
(**) Term: **15 Years**
(21) Appl. No.: **29/647,623**

D502,537 S *	3/2005	Gibson	D23/311
D519,619 S *	4/2006	Bill	D23/298
D534,003 S *	12/2006	McNally	D6/300
D600,335 S *	9/2009	Cleppe	D23/311
D619,686 S *	7/2010	Robinson	D23/311
D631,532 S *	1/2011	Sayre	D23/311
D663,920 S *	7/2012	Wexler	D2/712
D759,792 S *	6/2016	Flury	D23/261
D824,496 S *	7/2018	D'Amico	D23/261
10,400,434 B2 *	9/2019	Seimiya	E03F 1/006
2006/0053541 A1	3/2006	Howard		
2009/0049591 A1	2/2009	Orona, Jr.		
2011/0123761 A1 *	5/2011	Wright	A47G 27/0206 428/116

(22) Filed: **May 15, 2018**
(51) **LOC (12) Cl.** **23-01**
(52) **U.S. Cl.**
USPC **D23/311**
(58) **Field of Classification Search**
USPC D23/295-301, 303, 309, 311-313
CPC A47K 11/02; A47K 11/026; A47K 11/00;
A47K 13/00; E03D 11/18; E03D 5/10;
E03D 13/00

* cited by examiner

Primary Examiner — Lakiya G Rogers
Assistant Examiner — John A Voytek

See application file for complete search history.

(57) **CLAIM**

I claim the ornamental design for a toilet bowl safety screen, as shown and described.

DESCRIPTION

FIG. 1 is a front view of the toilet bowl safety screen.
FIG. 2 is a rear view of the claimed design.
FIG. 3 is a right side view of the claimed design.
FIG. 4 is a left side view of the claimed design.
FIG. 5 is a top view of the claimed design.
FIG. 6 is a bottom view of the claimed design; and,
FIG. 7 is a perspective view of the claimed design.
The broken lines appearing on FIG. 7 of a toilet are environmental matter forming no part of the claimed design.

(56) **References Cited**
U.S. PATENT DOCUMENTS

2,617,996 A	11/1952	Hoffman	
3,860,971 A	1/1975	Dirks	
5,003,641 A	4/1991	Selman, Jr.	
5,581,824 A	12/1996	Crook, Sr.	
5,930,847 A	8/1999	Hall	
6,108,827 A	8/2000	Espadas	
D486,341 S *	2/2004	Ruhl D6/583
D497,277 S *	10/2004	Ruhl D6/582

1 Claim, 5 Drawing Sheets

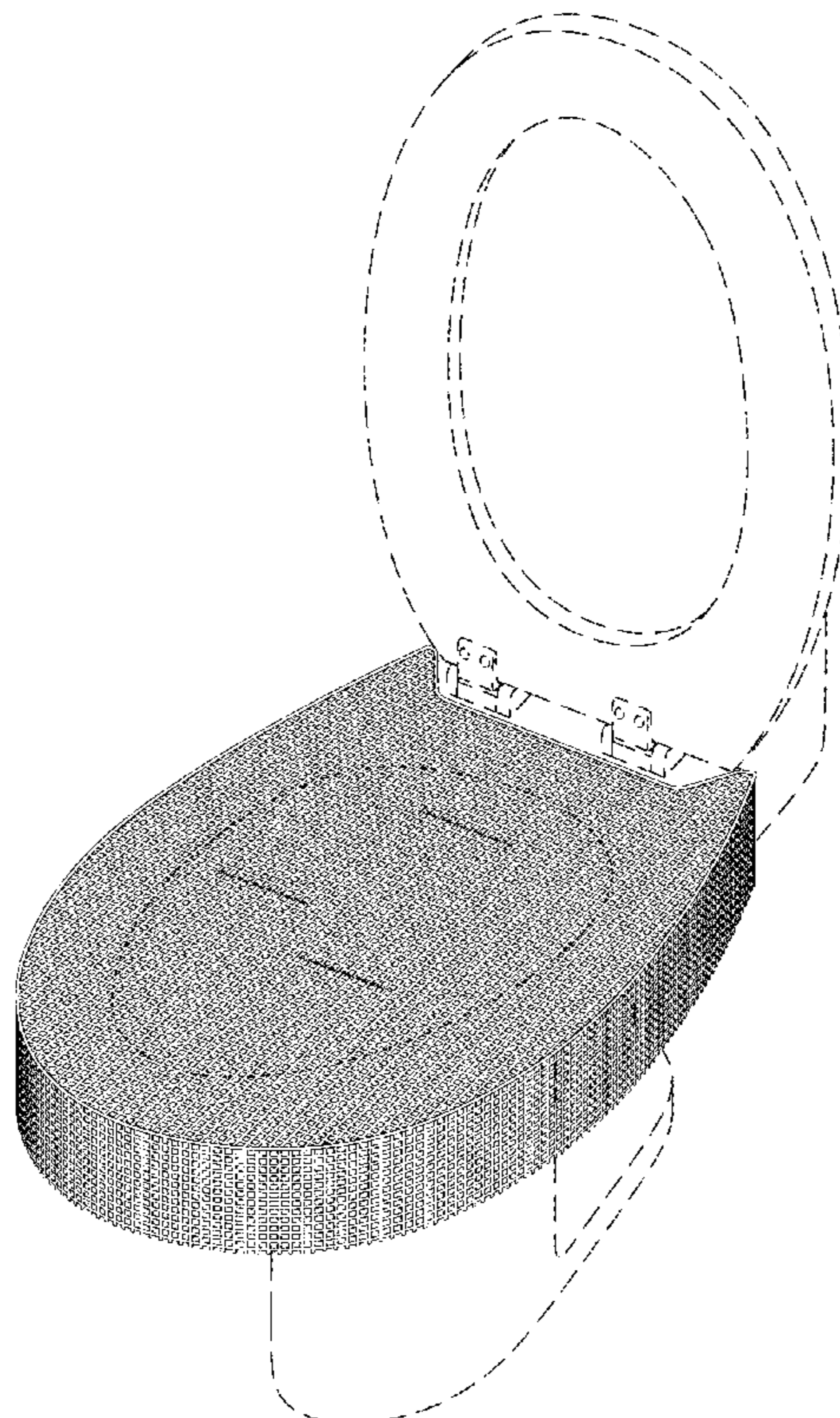

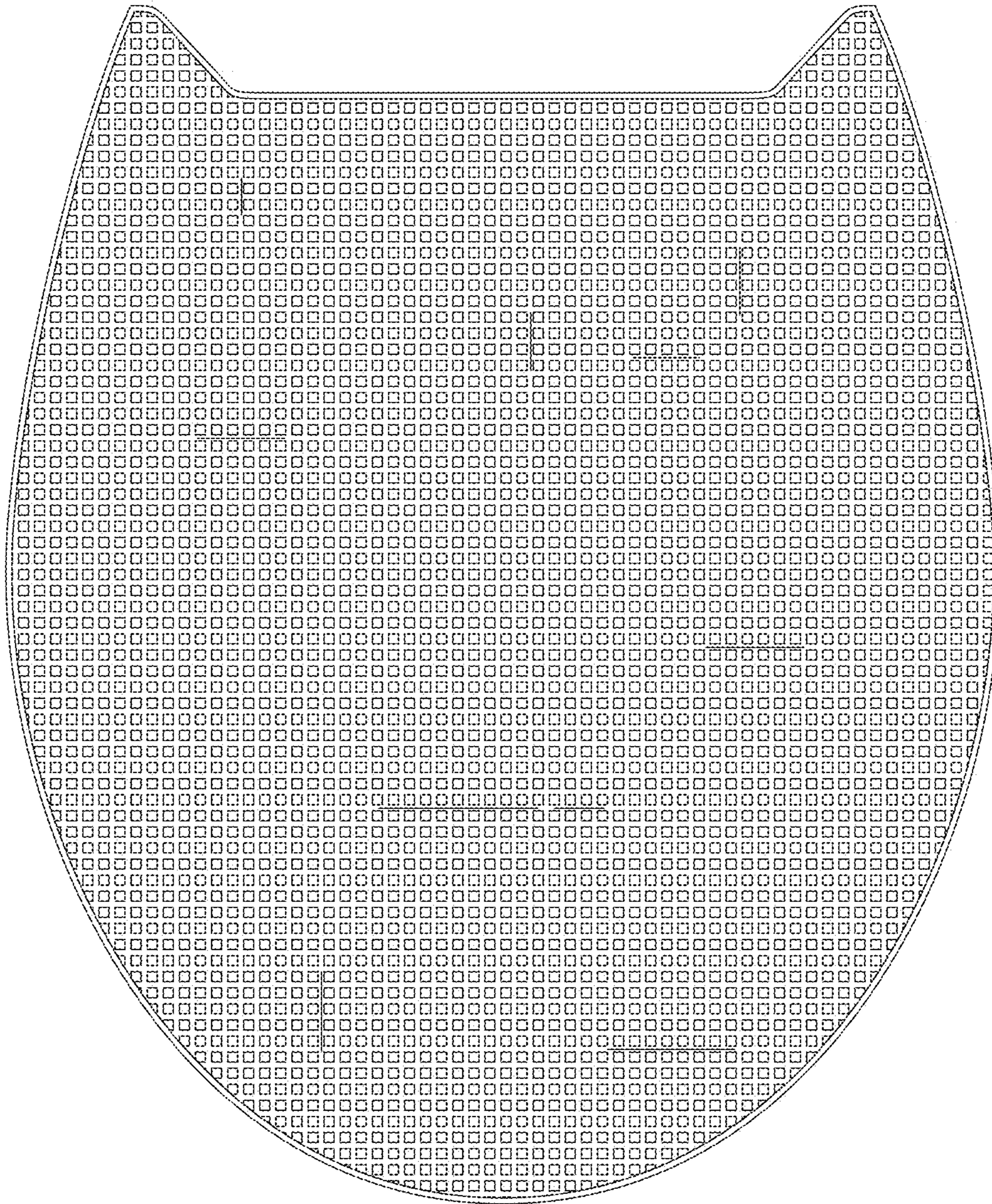

FIG. 1

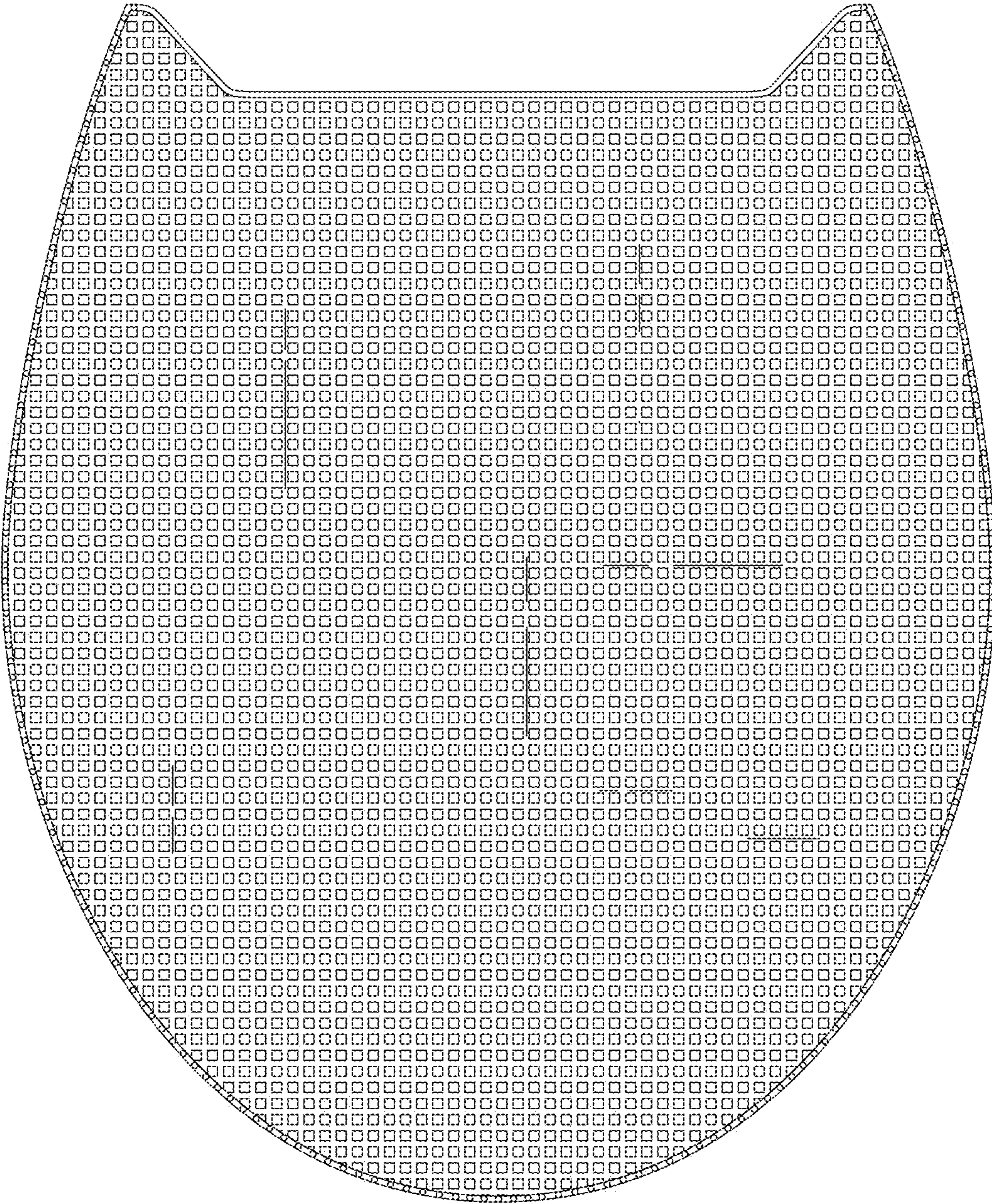

FIG. 2

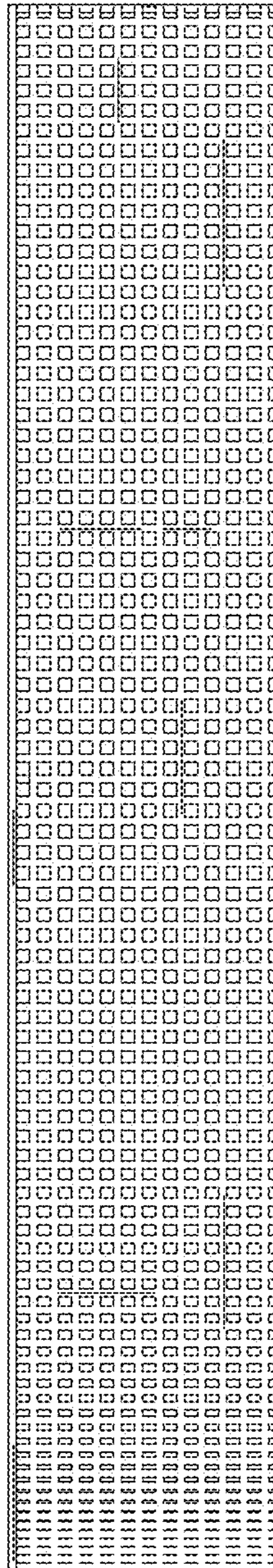

FIG. 3

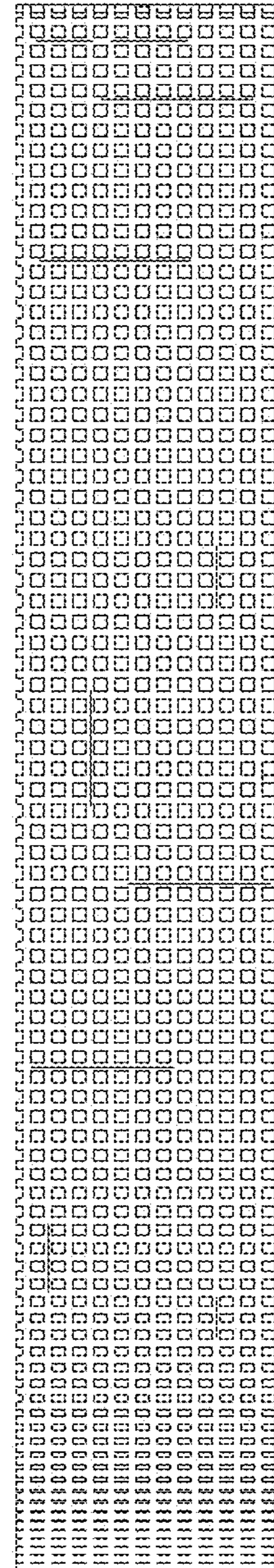

FIG. 4

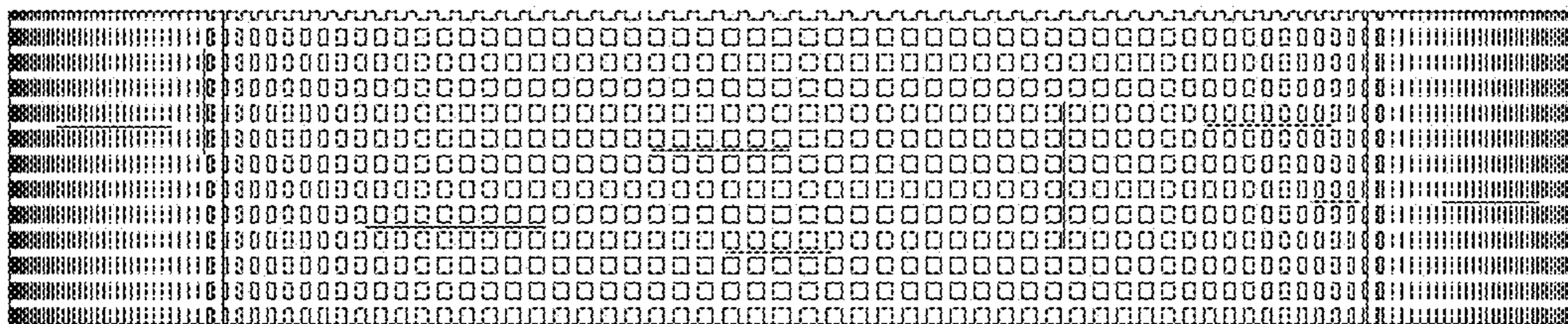

FIG. 5

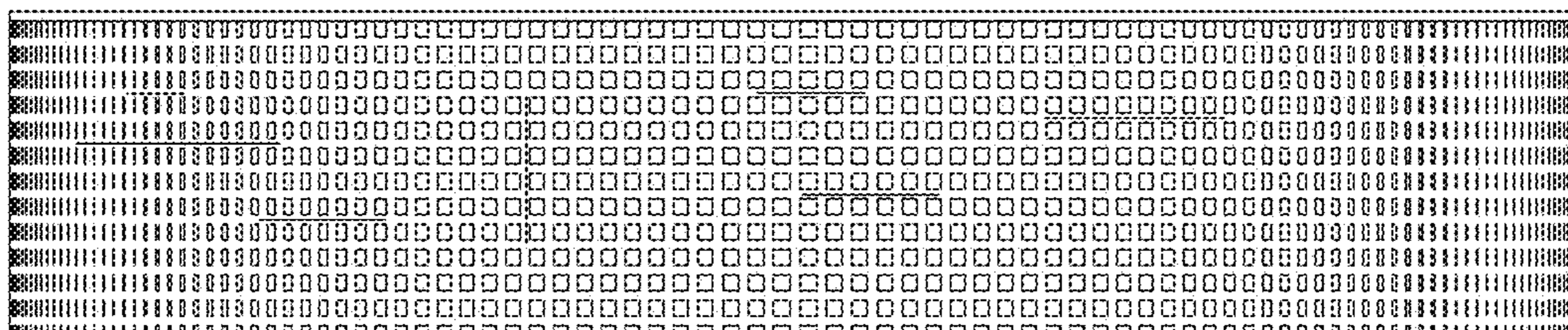

FIG. 6

FIG. 7

