

US00D895611S

(12) **United States Design Patent** (10) **Patent No.:** **US D895,611 S**
Chen et al. (45) **Date of Patent:** **** Sep. 8, 2020**

(54) **ELECTRONIC DEVICE WITH FLIPPABLE DISPLAY**

HP-Spectre-13-V011DX-i7-6500U-Windows/dp/B01M3PP48R> (Year: 2017).*

(Continued)

(71) Applicants: **Wei-Ting Chen**, Taipei (TW);
Tzu-Chien Lai, Taipei (TW);
Yen-Hsiao Yeh, Taipei (TW);
Nien-Chen Lee, Taipei (TW)

Primary Examiner — Kevin K Rudzinski
Assistant Examiner — Kathleen L Jones
(74) *Attorney, Agent, or Firm* — JCIPRNET

(72) Inventors: **Wei-Ting Chen**, Taipei (TW);
Tzu-Chien Lai, Taipei (TW);
Yen-Hsiao Yeh, Taipei (TW);
Nien-Chen Lee, Taipei (TW)

(57) **CLAIM**

The ornamental design for an electronic device with flippable display, as shown and described.

(73) Assignee: **COMPAL ELECTRONICS, INC.**,
Taipei (TW)

DESCRIPTION

(**) Term: **15 Years**

FIG. 1 is a perspective view of an electronic device with flippable display showing our new design with the display closed;

(21) Appl. No.: **29/649,717**

FIG. 2 is a front view thereof;

(22) Filed: **Jun. 1, 2018**

FIG. 3 is a rear view thereof;

(51) **LOC (12) Cl.** **14-02**

FIG. 4 is a left side view thereof;

(52) **U.S. Cl.**

FIG. 5 is a right side view thereof;

USPC **D14/316; D14/327**

FIG. 6 is a top view thereof;

(58) **Field of Classification Search**

FIG. 7 is a bottom view thereof;

USPC D14/315–328, 331, 334–336, 339–340,
D14/374; D18/1–2, 7, 11, 12.2–12.3

FIG. 8 is a perspective view of the electronic device with flippable display of FIGS. 1-7 shown in an alternate position with the display open;

(Continued)

FIG. 9 is a front view thereof;

(56) **References Cited**

FIG. 10 is a rear view thereof;

U.S. PATENT DOCUMENTS

FIG. 11 is a left side view thereof;

D370,214 S * 5/1996 Kondo D14/319

FIG. 12 is a right side view thereof;

D370,217 S * 5/1996 Kondo D14/327

FIG. 13 is a top view thereof;

(Continued)

FIG. 14 is a bottom view thereof;

FOREIGN PATENT DOCUMENTS

FIG. 15 is a perspective view of the electronic device with flippable display of FIGS. 1-7 shown in another alternate position with the display opened laterally;

KR 3006725720000 12/2012

FIG. 16 is a front view thereof;

OTHER PUBLICATIONS

FIG. 17 is a rear view thereof;

HP Spectre 13-V011DX, posted at Amazon, review posted Jan. 16, 2017. Site visited Oct. 30, 2019. URL: <<https://www.amazon.com/>>

FIG. 18 is a left side view thereof;

FIG. 19 is a right side view thereof;

FIG. 20 is a top view thereof; and,

FIG. 21 is a bottom view thereof.

(Continued)

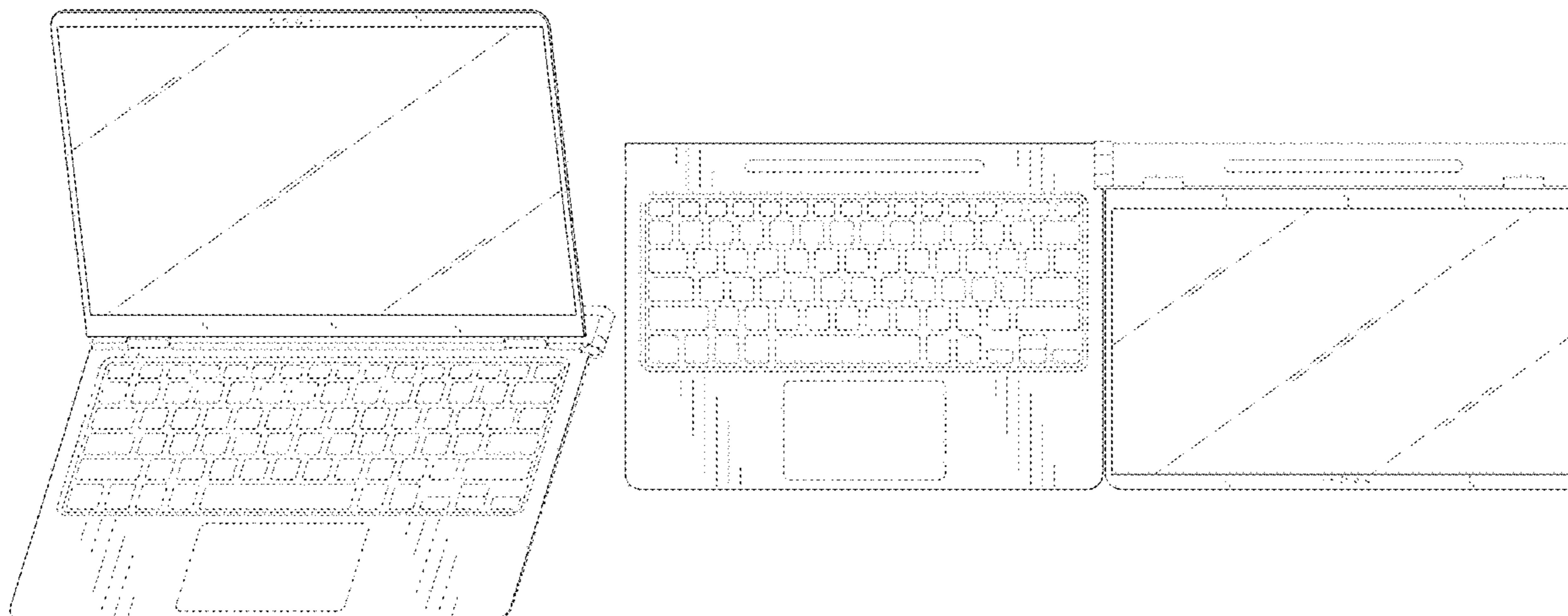

The dashed broken lines illustrate portions of the electronic device with flippable display and form no part of the claimed design.

1 Claim, 12 Drawing Sheets

(58) Field of Classification Search

CPC G06F 1/166; G06F 1/1613; G06F 1/1616;
 G06F 1/1618; G06F 1/162; G06F 1/1622;
 G06F 1/1624; G06F 1/1633; G06F
 1/1615; G06F 1/1643; G06F 1/1654;
 G06F 1/1669; G06F 1/203; G06F 1/1688

See application file for complete search history.

(56) References Cited

U.S. PATENT DOCUMENTS

D371,118	S	*	6/1996	Kondo	D14/172
D375,086	S	*	10/1996	Kondo	D14/319
D425,874	S	*	5/2000	Tanimura	D14/318
D430,868	S	*	9/2000	Cho	D14/315
D608,778	S	*	1/2010	Lee	D14/336
D620,935	S	*	8/2010	Chang	D14/374
D648,335	S	*	11/2011	Shiono	D14/374
D673,559	S	*	1/2013	Yang	D14/318
D675,199	S	*	1/2013	Wen	D14/315
D675,611	S	*	2/2013	Wen	D14/315
D705,774	S	*	5/2014	Hung	D14/316
D706,259	S	*	6/2014	Myung	D14/315

D708,605	S	*	7/2014	Yang	D14/315
D712,399	S	*	9/2014	Sohn	D14/336
D717,296	S	*	11/2014	Oh	D14/316
D719,562	S	*	12/2014	Kim	D14/315
D723,029	S	*	2/2015	Seoc	D14/336
D724,075	S	*	3/2015	Sohn	D14/315
D727,309	S	*	4/2015	Senatori	D14/315
D727,891	S	*	4/2015	Lee	D14/315
D753,647	S	*	4/2016	Mehandjiysky	D14/315
D769,874	S	*	10/2016	Kung	D14/374
D790,543	S	*	6/2017	Chu	D14/374
D804,466	S	*	12/2017	Okuley	D14/315
D807,343	S	*	1/2018	Goh	D14/315
D807,875	S	*	1/2018	Senatori	D14/316
D837,202	S	*	1/2019	Lee	D14/315
2015/0192960	A1	*	7/2015	Sharma	G06F 3/1462 345/2.2
2018/0096642	A1	*	4/2018	Vishakantaiah	G06F 1/1616
2019/0250673	A1	*	8/2019	Chen	G06F 1/1679

OTHER PUBLICATIONS

Horsey, Julian, Compal DuoFlip concept laptop offers unique features, posted at Geeky Gadgets, posting date Mar. 21, 2019. Site visited Oct. 30, 2019. URL: <<https://www.geeky-gadgets.com/compal-duoflip-concept-laptop-21-03-2019>> (Year: 2019).*

Lenovo Flex 4, posted at Lenovo US, review posted 2017. Site visited Oct. 30, 2019. URL: <<https://www.lenovo.com/us/en/laptops/ideapad/ideapad-flex-series/Lenovo-ideapad-FLEX-4-1470/p/88IP8FX0685?bvstate=pg:4/ct:q>> (Year: 2017).*

* cited by examiner

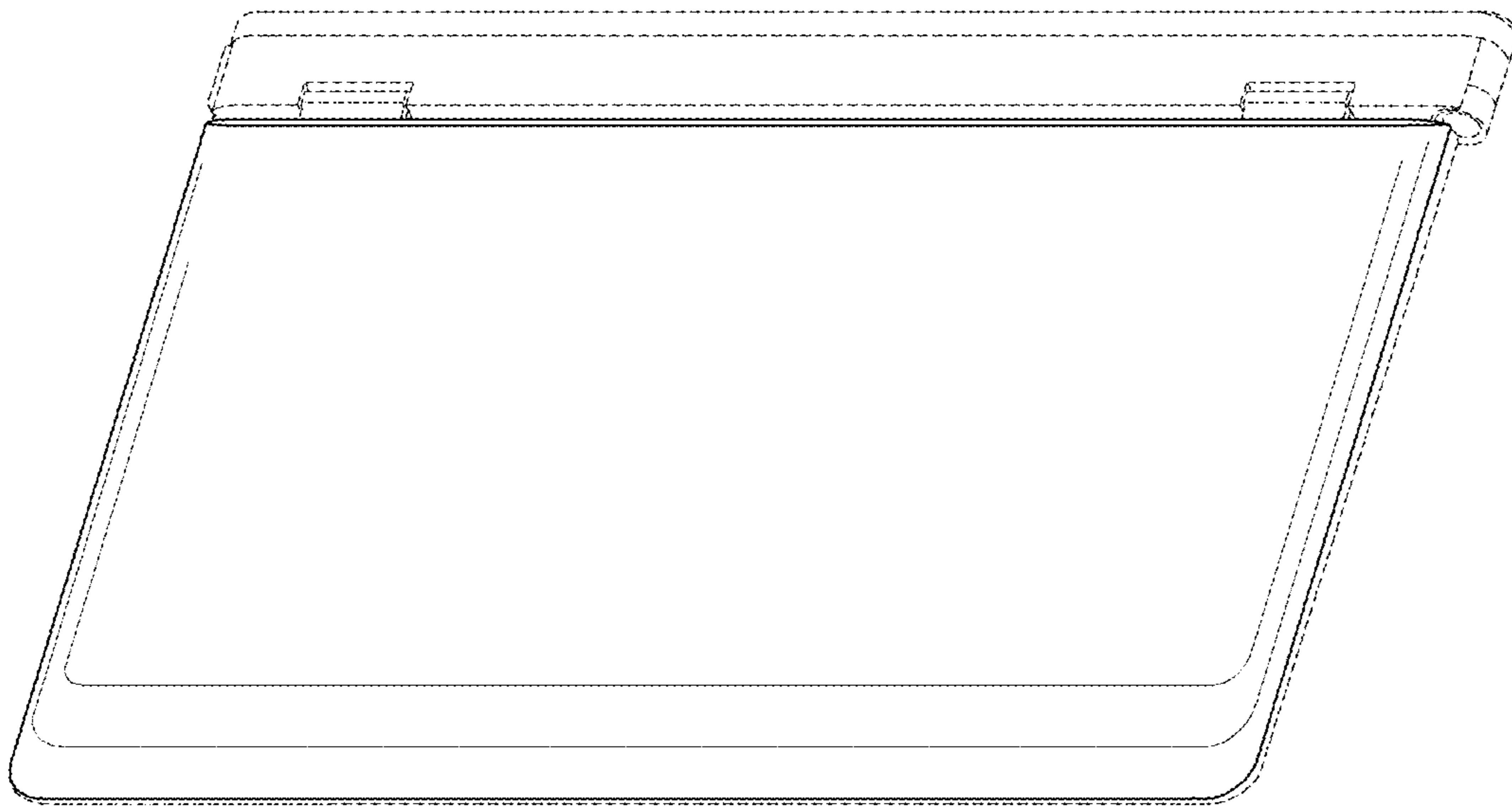

FIG. 1

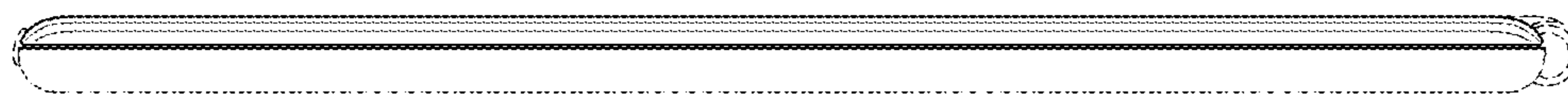

FIG. 2

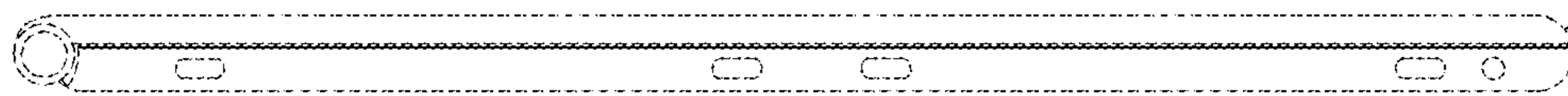

FIG. 3

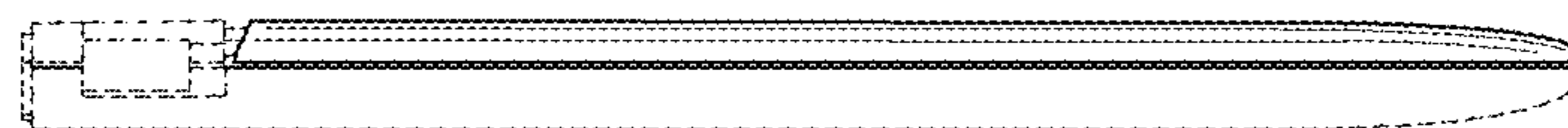

FIG. 4

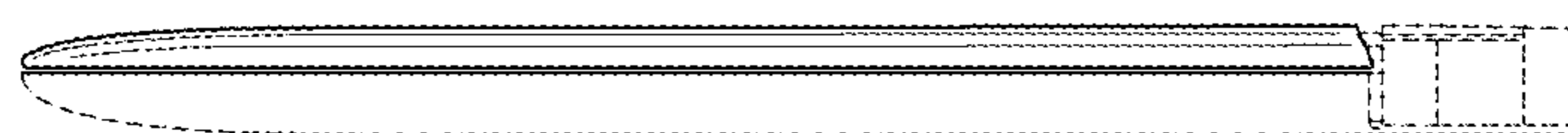

FIG. 5

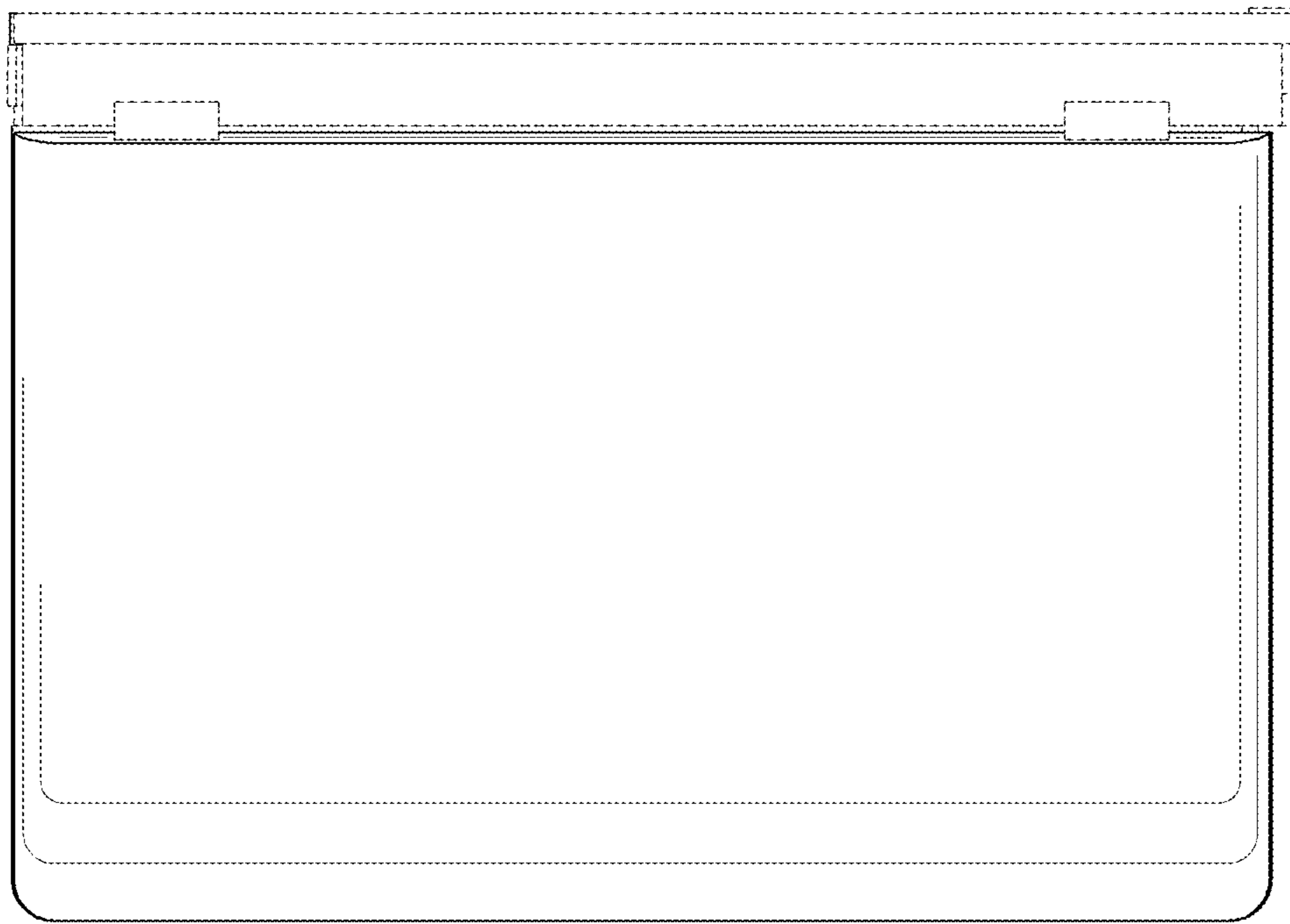

FIG. 6



FIG. 7

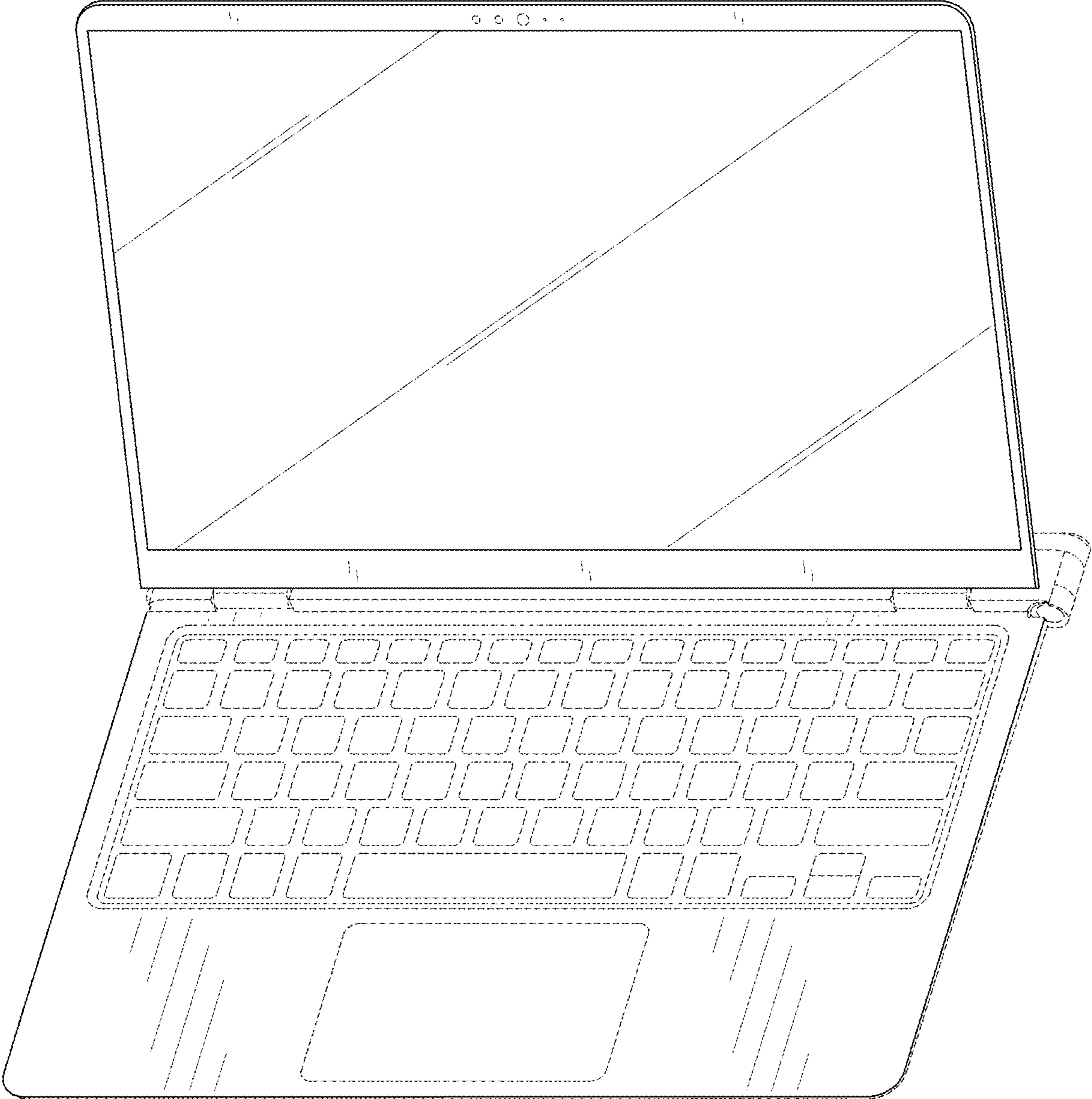

FIG. 8

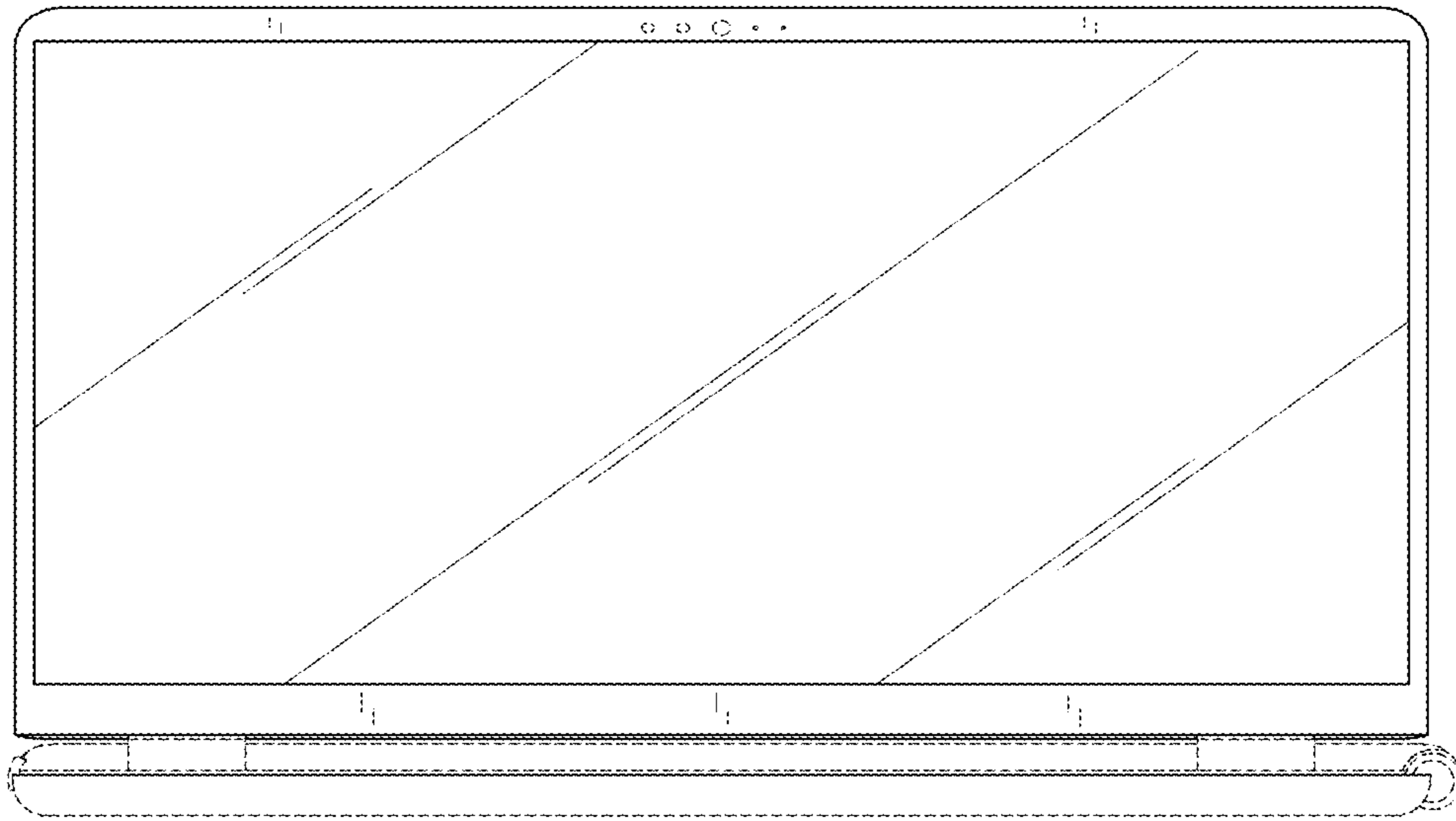

FIG. 9



FIG. 10

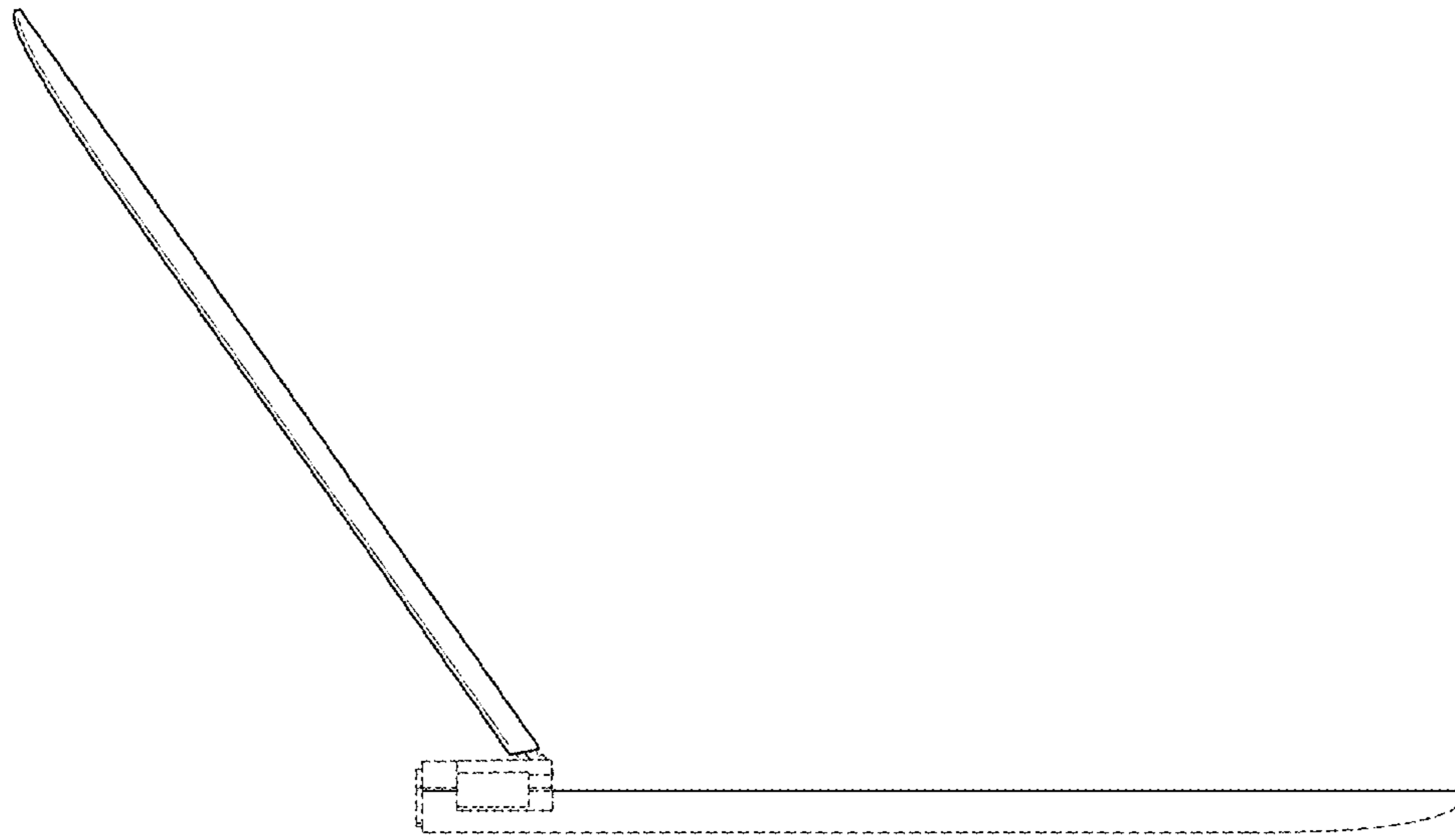

FIG. 11

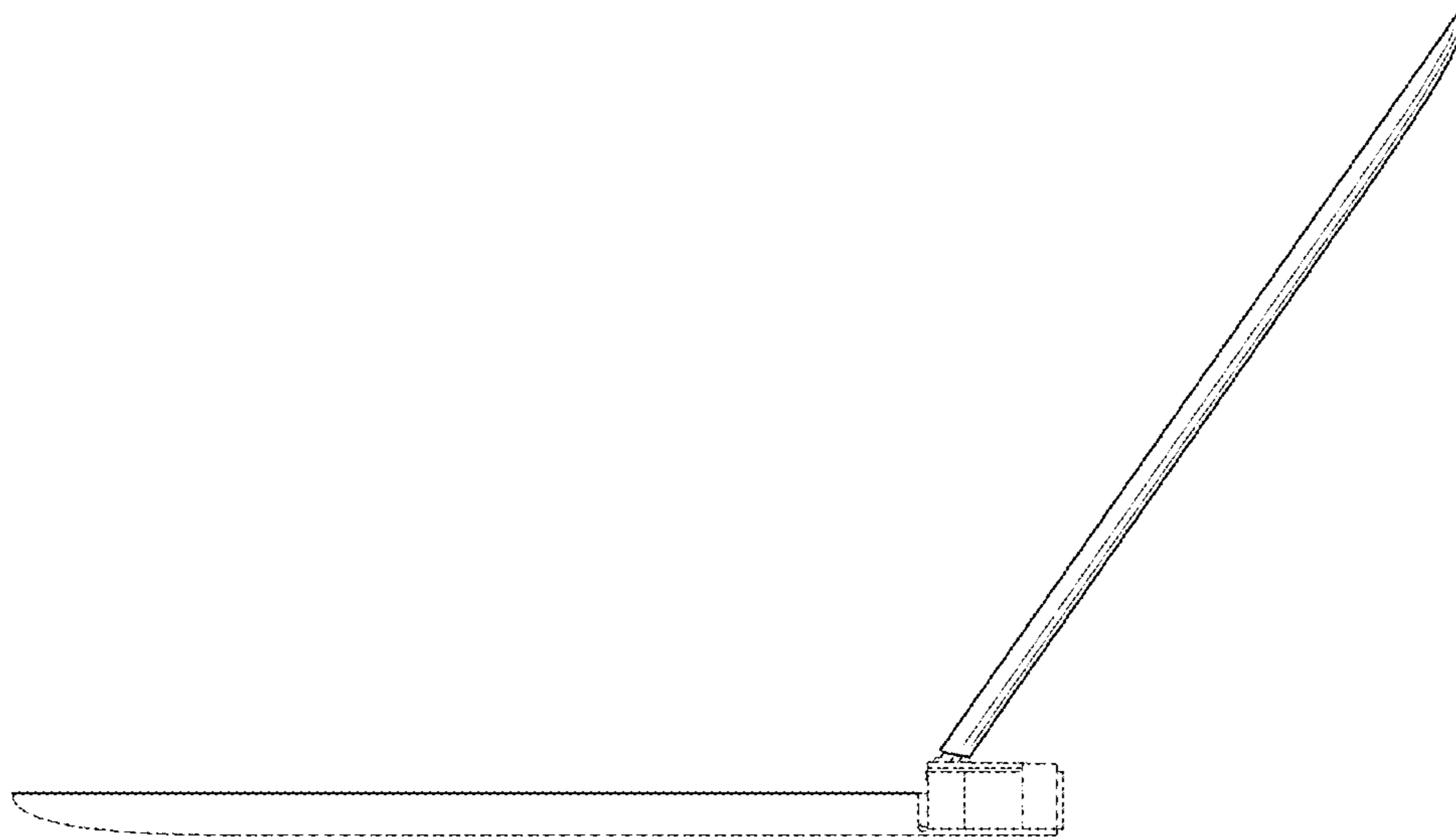

FIG. 12

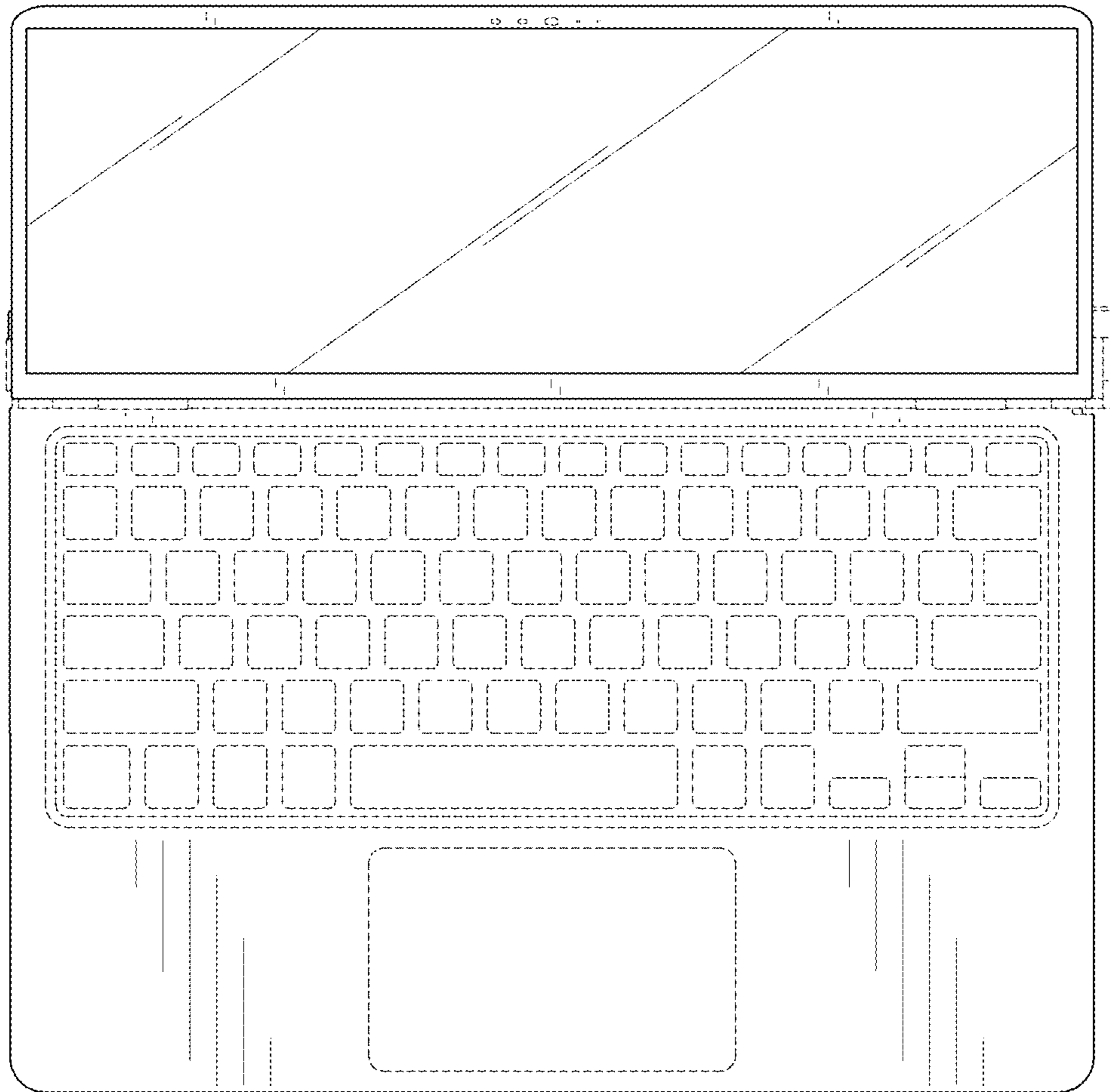

FIG. 13

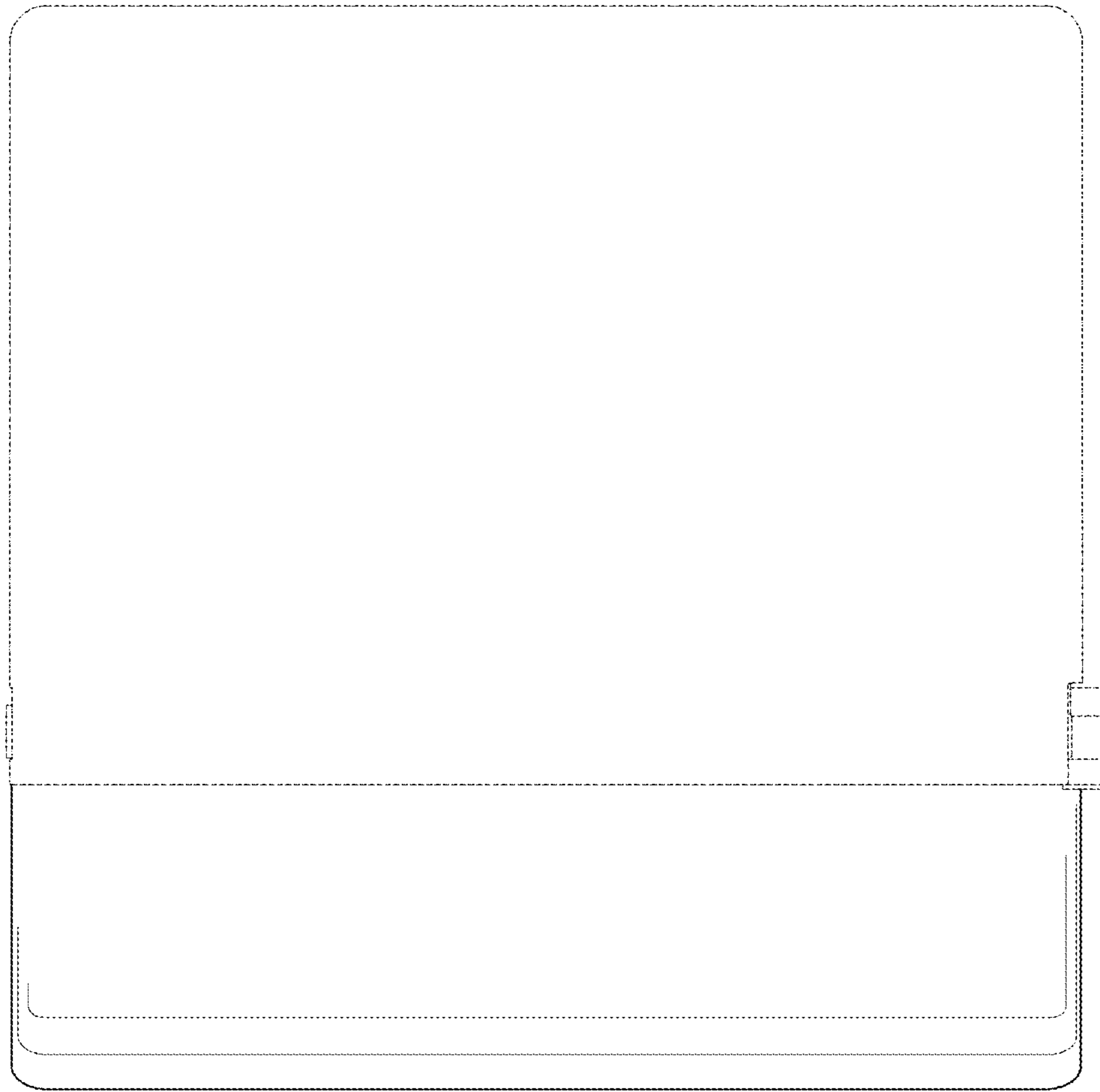

FIG. 14

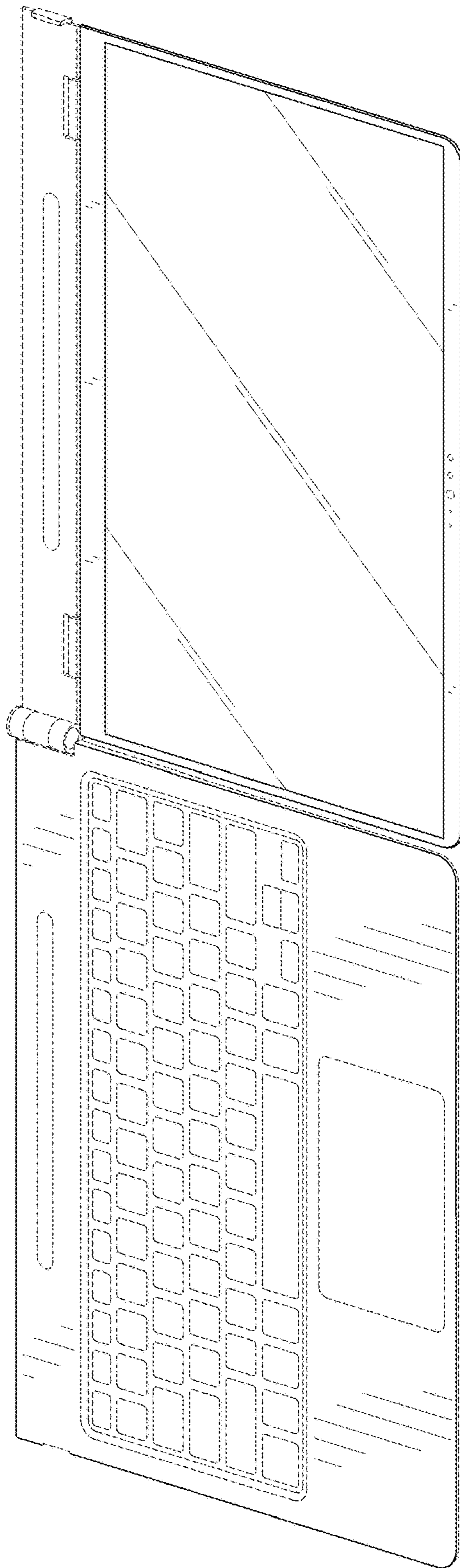

FIG. 15



FIG. 16



FIG. 17

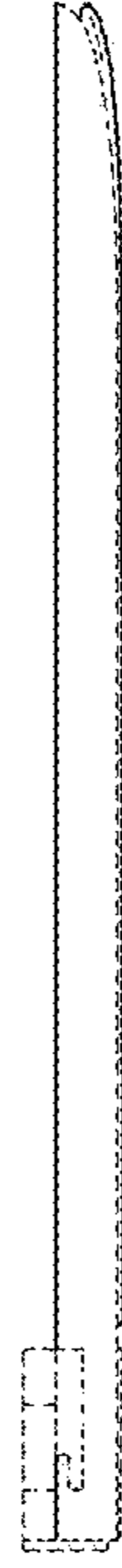

FIG. 18



FIG. 19

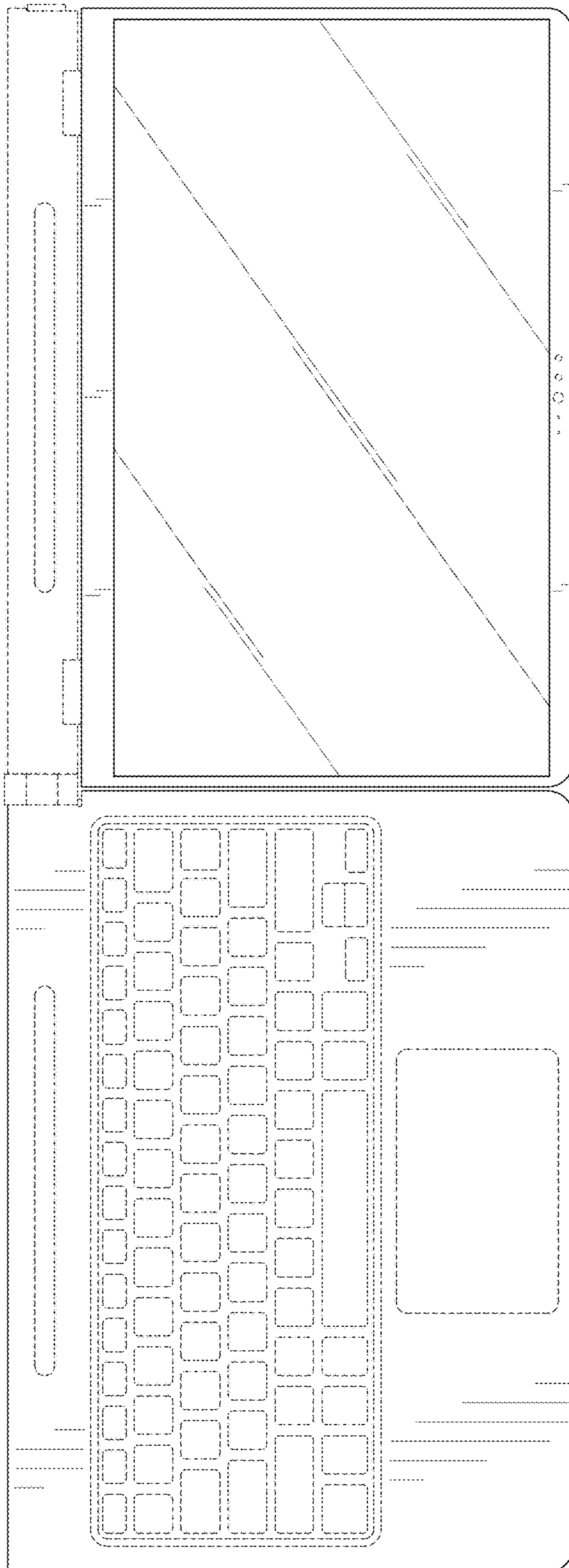

FIG. 20

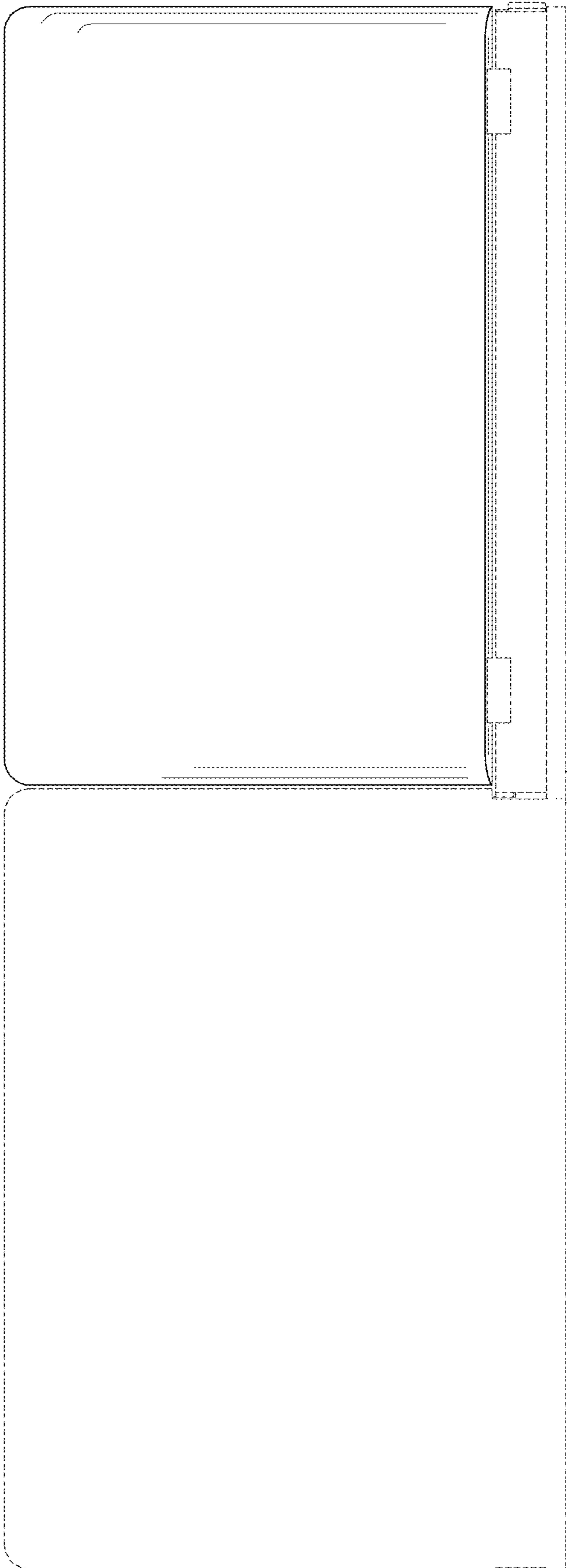

FIG. 21