



US00D895495S

(12) **United States Design Patent** (10) **Patent No.:** **US D895,495 S**
Grewer (45) **Date of Patent:** **** Sep. 8, 2020**

(54) **FRONT FENDER VENT FOR A VEHICLE** D873,192 S * 1/2020 Smith H04R 9/047
D12/190
(71) Applicant: **Jaguar Land Rover Limited**, Whitley, D874,368 S * 2/2020 Smith H04R 7/045
Coventry (GB) D12/190
D874,369 S * 2/2020 Donfrancesco H04R 1/023
(72) Inventor: **Dale Grewer**, Coventry (GB) 2014/0029773 A1* 1/2014 Kano H04R 17/00
381/190

(73) Assignee: **Jaguar Land Rover Limited**, Whitley
Coventry (GB)

(**) Term: **15 Years**

(21) Appl. No.: **29/638,003**

(22) Filed: **Feb. 23, 2018**

(30) **Foreign Application Priority Data**

Sep. 6, 2017 (EM) 004244275

(51) **LOC (12) Cl.** **12-16**

(52) **U.S. Cl.**
USPC **D12/190**

(58) **Field of Classification Search**
CPC B60R 13/043; B60R 2013/0293; B60R
13/02; B60R 13/04
See application file for complete search history.

(56) **References Cited**

U.S. PATENT DOCUMENTS

5,754,664 A * 5/1998 Clark B60R 11/0217
296/214
D801,897 S * 11/2017 Buck B60R 13/0243
D12/190
D808,316 S * 1/2018 Piscitelli D12/190
D808,317 S * 1/2018 Piscitelli D12/190
D821,279 S * 6/2018 Szavits B60R 11/0217
D12/190
D834,111 S * 11/2018 Soward D21/561
D836,507 S * 12/2018 Nguyen B60R 11/0217
D12/190
D842,767 S * 3/2019 Hjorten D12/163
D849,616 S * 5/2019 Nurnberger B60R 11/0217
D12/190

* cited by examiner

Primary Examiner — Katrina A Betton

(57) **CLAIM**

The ornamental design for a front fender vent for a vehicle,
as shown and described.

DESCRIPTION

FIG. 1 is a front right perspective view of a front fender vent
for a vehicle according to the present invention.
FIG. 2 is a front left perspective view of the front fender vent
shown in FIG. 1.
FIG. 3 is a rear left perspective view thereof.
FIG. 4 is a rear right perspective view thereof.
FIG. 5 is a front view thereof.
FIG. 6 is a rear view thereof.
FIG. 7 is a left side view thereof.
FIG. 8 is a right side view thereof.
FIG. 9 is a top view thereof.
FIG. 10 is a bottom view thereof; and,
FIG. 11 is a front view of the front fender vent shown in
FIGS. 1-10, but with the front fender vent mounted on a
vehicle, and the rest of the vehicle shown in de-emphasized
and half-tone portions so as to illustrate environmental
structure. These portions form no part of the claimed inven-
tion. More specifically, in FIG. 11, the inventive front fender
vent is shown within the broken line, and the elements
shown outside the broken line form no part of the claimed
invention, but are instead included to show environmental
aspects thereof.

1 Claim, 9 Drawing Sheets

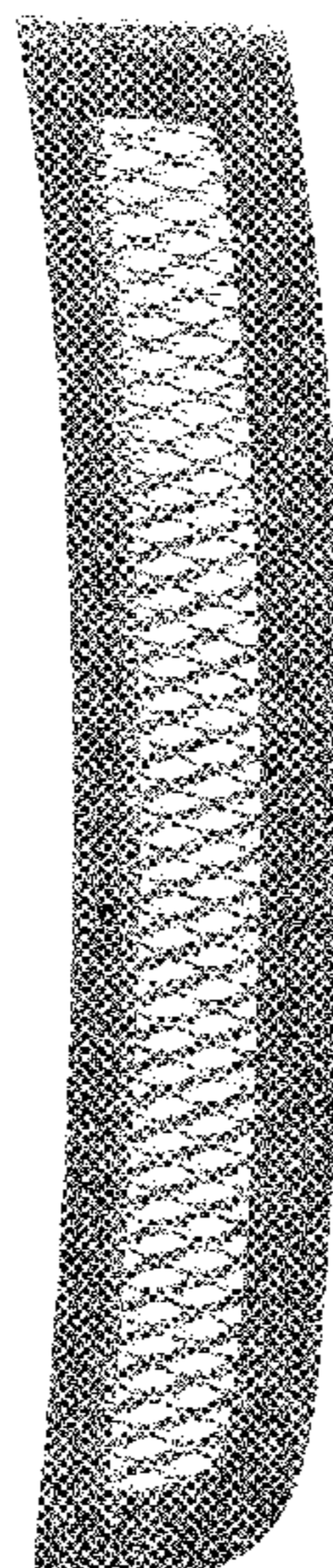

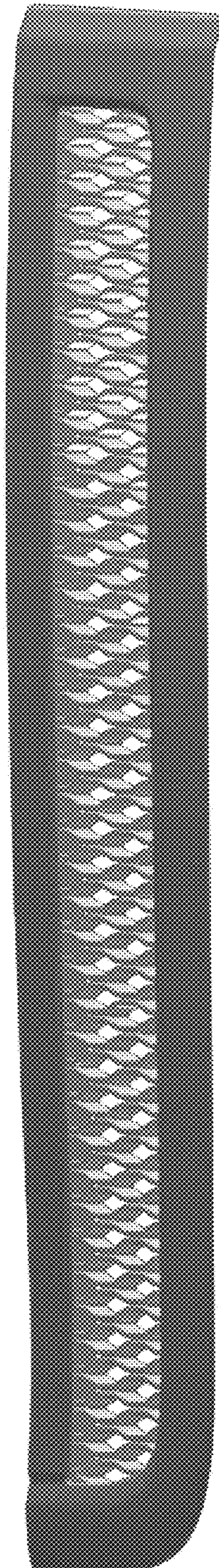

FIG. 1

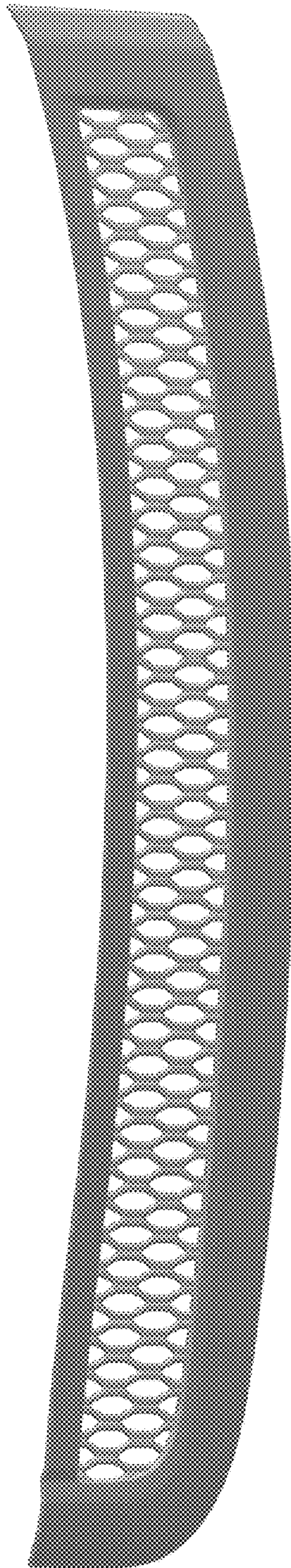

FIG. 2

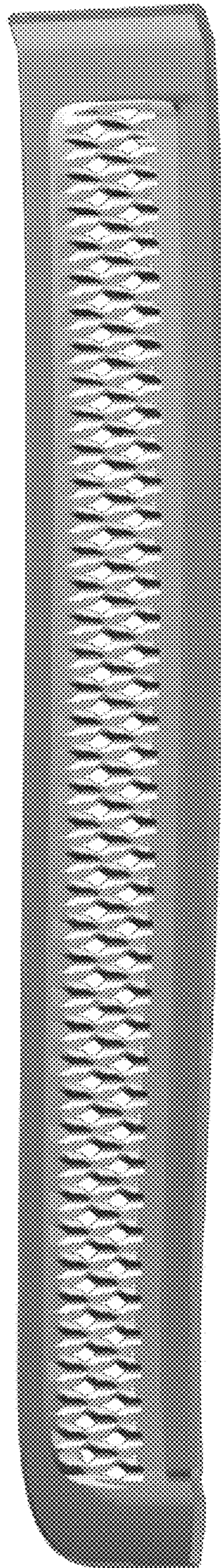

FIG. 3

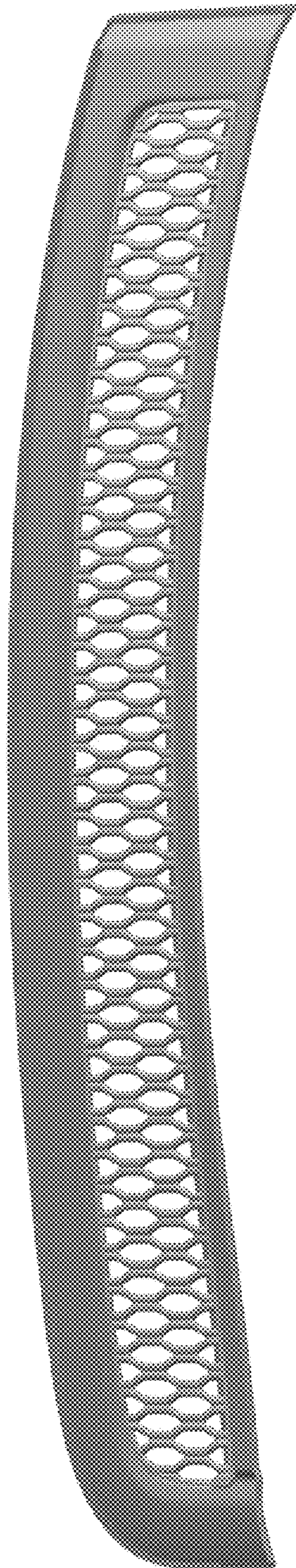

FIG. 4

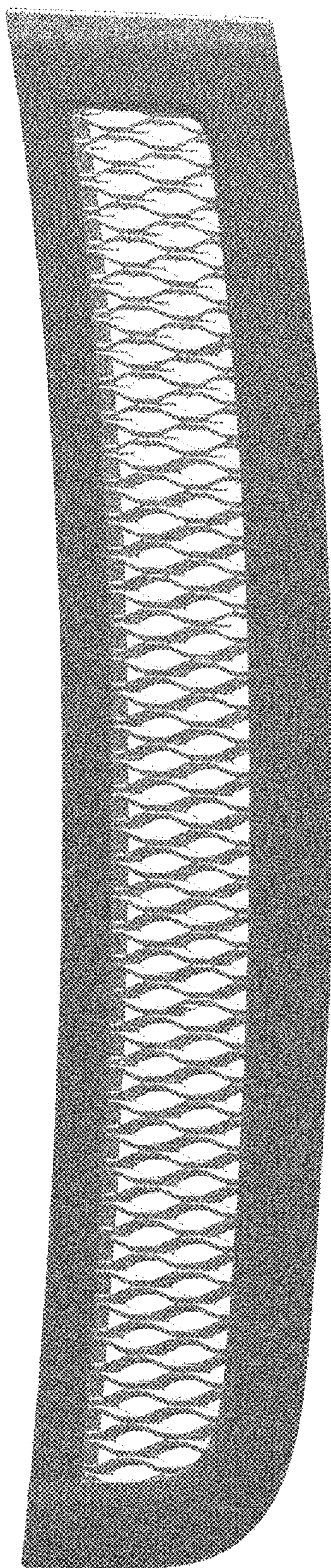

FIG. 5

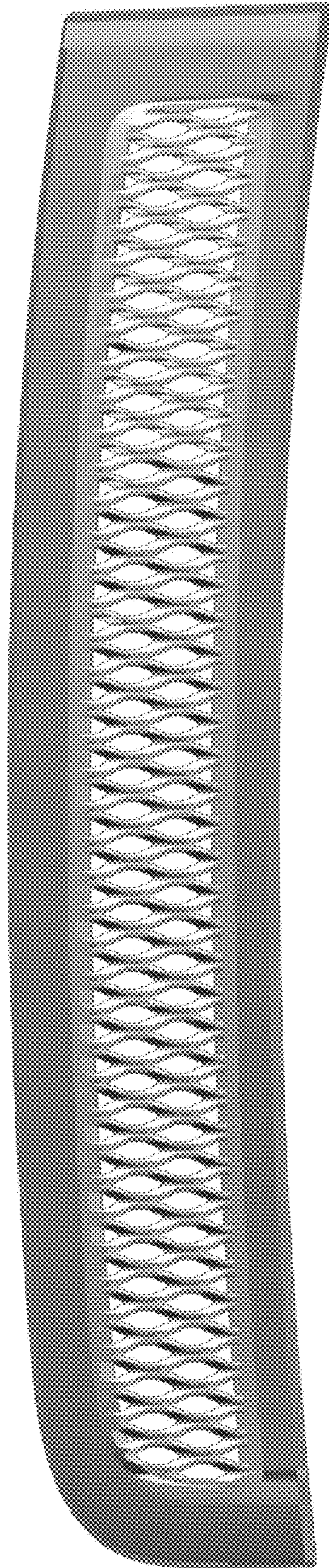

FIG. 6

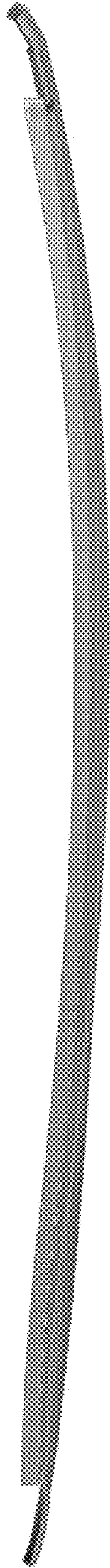

FIG. 7

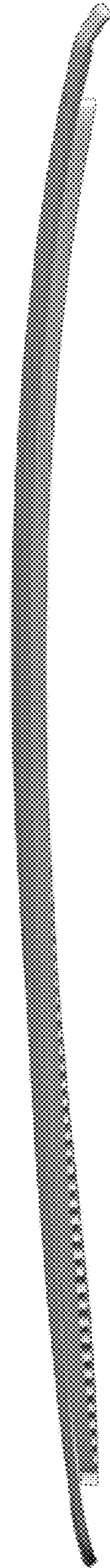

FIG. 8

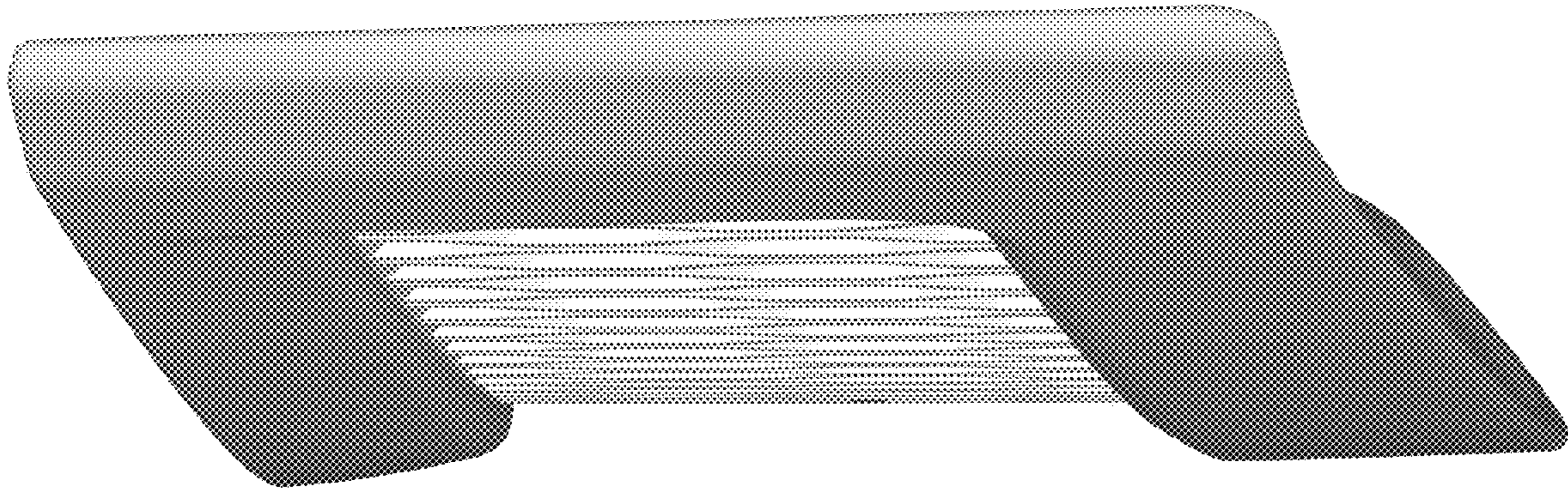

FIG. 9

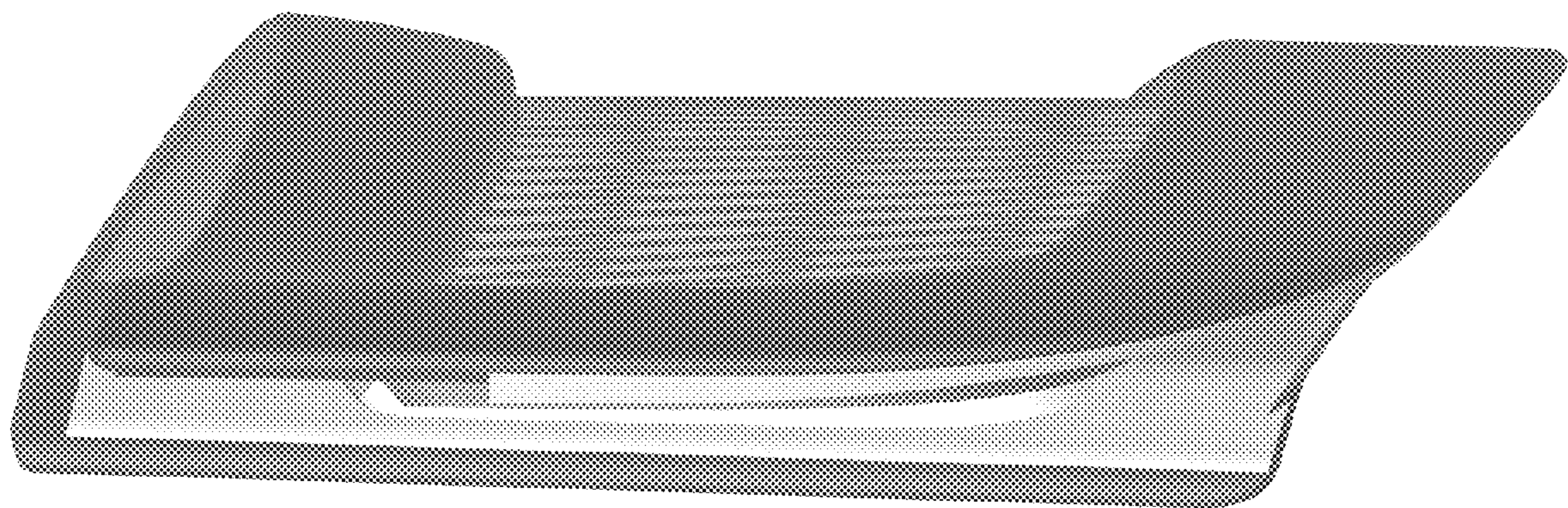

FIG. 10

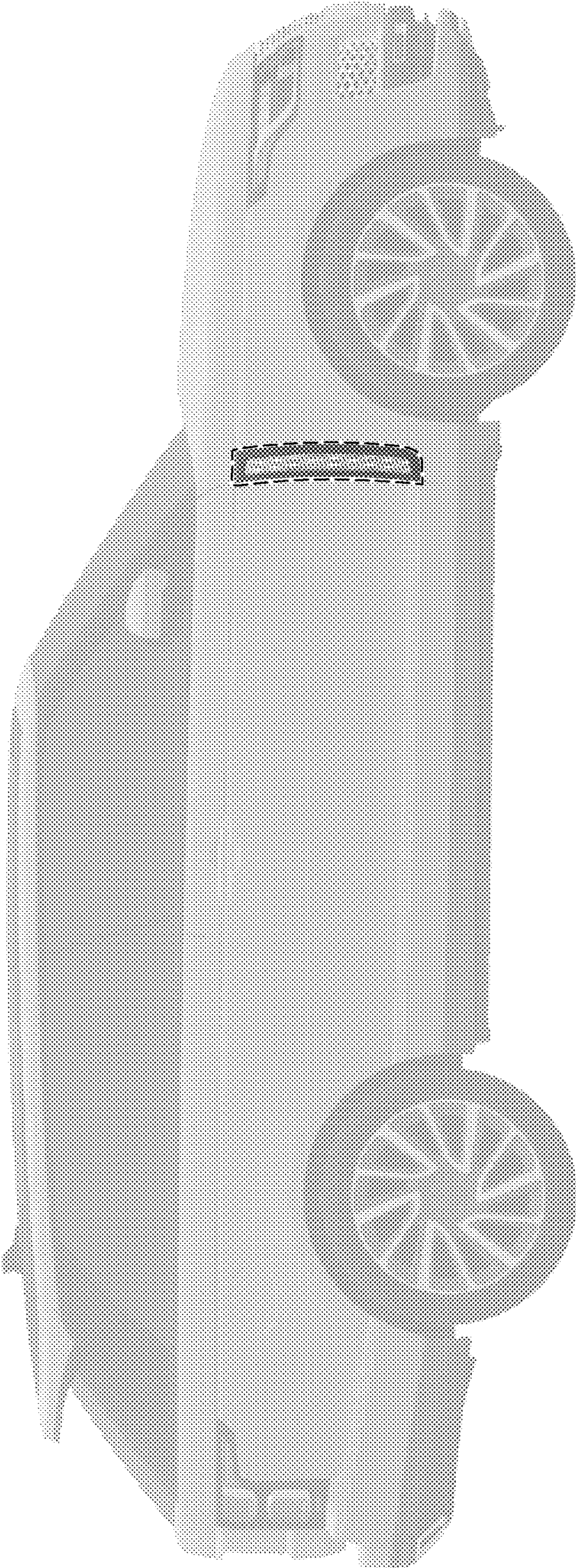

FIG. 11