

US00D895494S

(12) **United States Design Patent**
BerTrand

(10) **Patent No.:** **US D895,494 S**

(45) **Date of Patent:** **** Sep. 8, 2020**

- (54) **SIDEVIEW MIRROR GLARE SHIELD**
- (71) Applicant: **Styles BerTrand**, Beech Island, SC (US)
- (72) Inventor: **Styles BerTrand**, Beech Island, SC (US)
- (**) Term: **15 Years**
- (21) Appl. No.: **29/692,590**
- (22) Filed: **May 28, 2019**
- (51) **LOC (12) Cl.** **12-08**
- (52) **U.S. Cl.**
USPC **D12/183**
- (58) **Field of Classification Search**
USPC D6/300–314, 444, 396, 407, 632, 633, D6/492, 553; D20/40, 43; D19/10, 26, D19/27, 28, 32, 35, 36, 65, 90, 91; D9/414, 415, 418, 432, 711; D14/474, D14/477, 114, 239; D7/402, 405, 406; D12/182, 183, 193, 401, 191
CPC A47G 9/1045; E06B 9/24; A47H 23/02; B60J 11/08; B60J 3/02
See application file for complete search history.

D372,216 S *	7/1996	Denson	D12/183
5,553,908 A *	9/1996	Shink	B60J 11/08 160/370.21
D381,304 S *	7/1997	Ruimi	D12/183
D381,305 S *	7/1997	Ruimi	D12/183
D398,915 S *	9/1998	Shaffer	D14/450
D408,772 S *	4/1999	Li	D12/191
D410,422 S *	6/1999	Li	D12/191
D426,801 S	6/2000	Abernathy		
6,682,121 B1 *	1/2004	Conforti	B60J 11/08 160/370.21
6,997,501 B2	2/2006	Conforti		
7,398,816 B2 *	7/2008	Sala	A47H 23/02 160/10
D575,985 S *	9/2008	Delaney	D7/405
D646,901 S *	10/2011	Higgins	D6/300
8,342,226 B2 *	1/2013	Zheng	E06B 9/24 160/370.21
9,185,989 B1 *	11/2015	Parsons	A47G 9/1045

* cited by examiner

Primary Examiner — Susan E Krakower
Assistant Examiner — Jerry Shiuan-Hua Hsu

(57) **CLAIM**

I claim the ornamental design for a sideview mirror glare shield, as shown and described.

DESCRIPTION

FIG. 1 is a front view of the sideview mirror glare shield.
FIG. 2 is a rear view of the claimed design.
FIG. 3 is a left side view of the claimed design.
FIG. 4 is a right side view of the claimed design.
FIG. 5 is a top view of the claimed design.
FIG. 6 is a bottom view of the claimed design; and,
FIG. 7 is a perspective view of the claimed design.

1 Claim, 5 Drawing Sheets

(56) **References Cited**

U.S. PATENT DOCUMENTS

1,920,185 A *	8/1933	Carr, Jr.	B60J 3/02 296/97.7
2,070,434 A	2/1937	Kangas		
4,560,251 A	12/1985	Murjahn		
4,577,929 A	3/1986	Guillen		
4,943,103 A	7/1990	Rosen		
5,247,391 A	9/1993	Gormley		

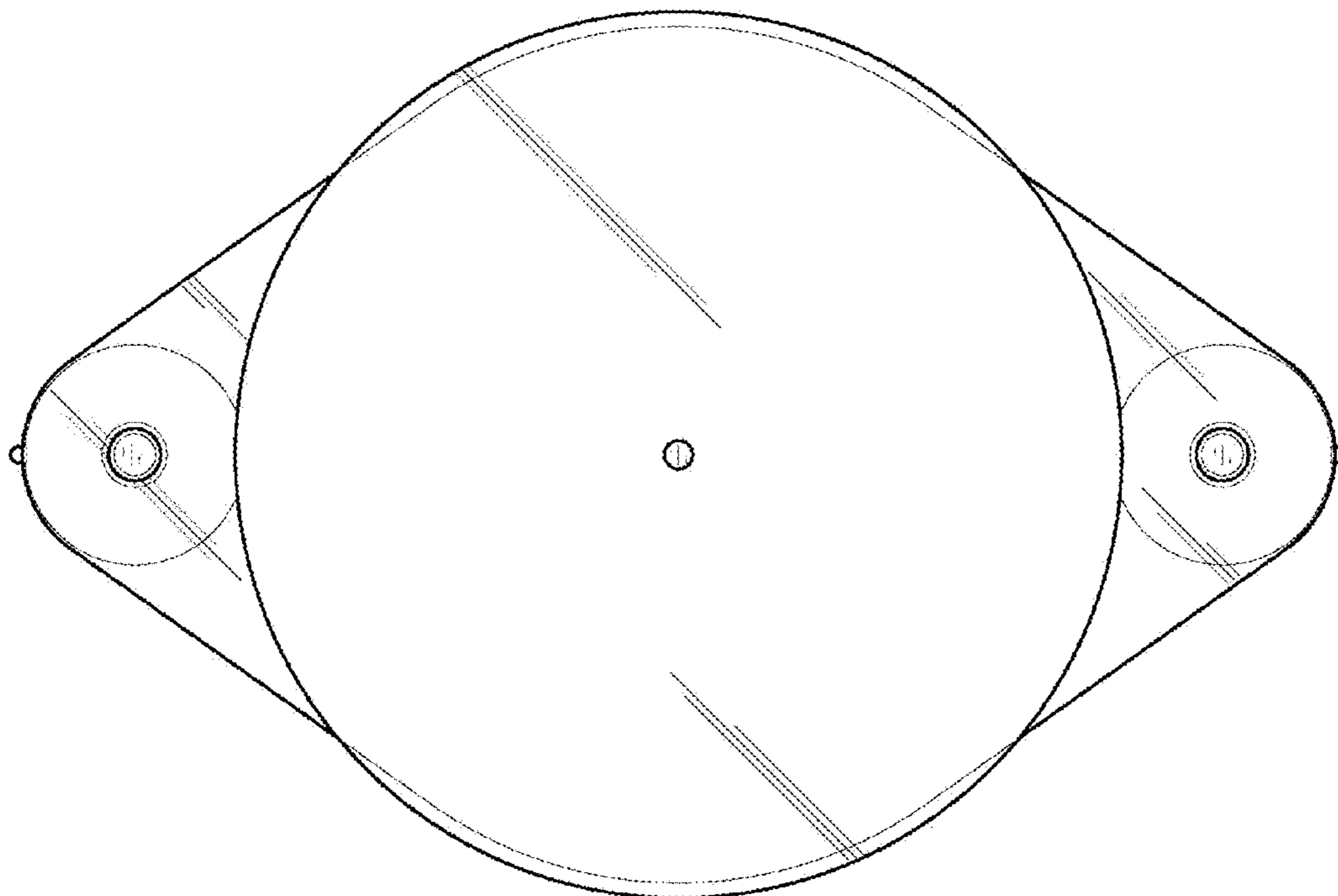

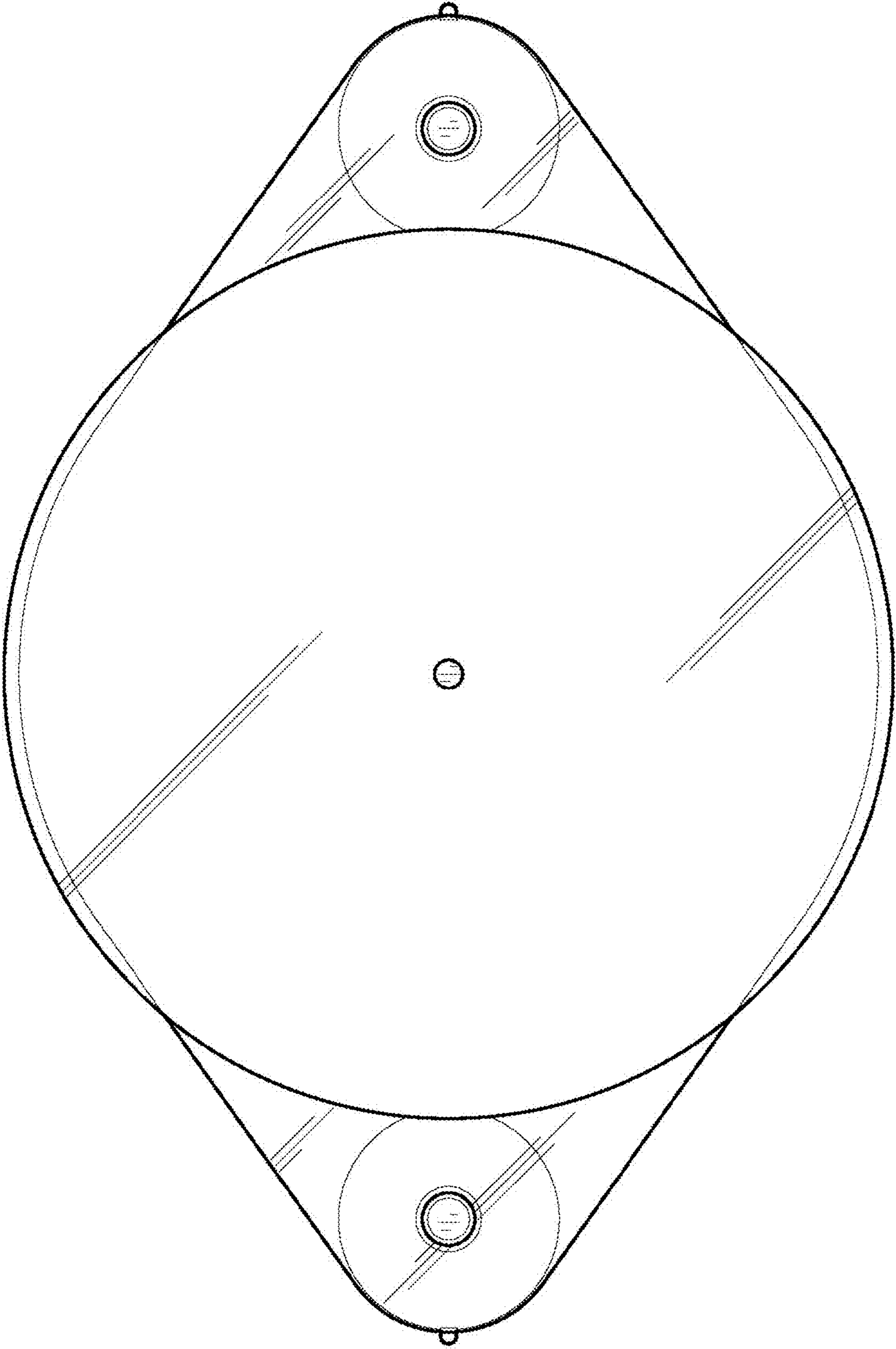

FIG. 1

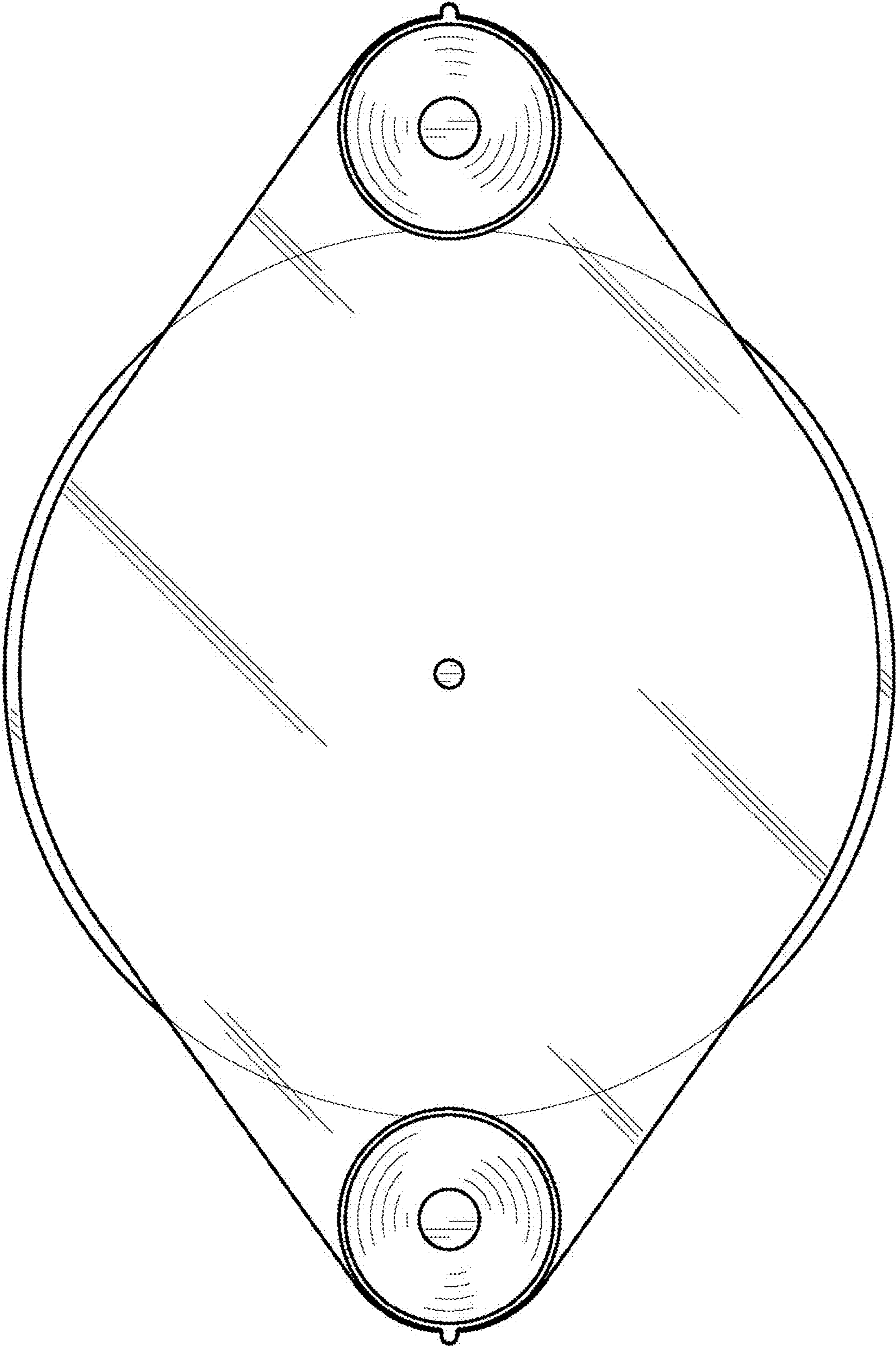

FIG. 2

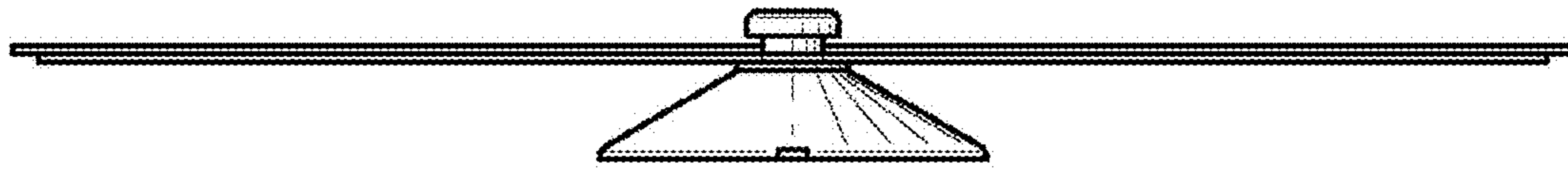

FIG. 4

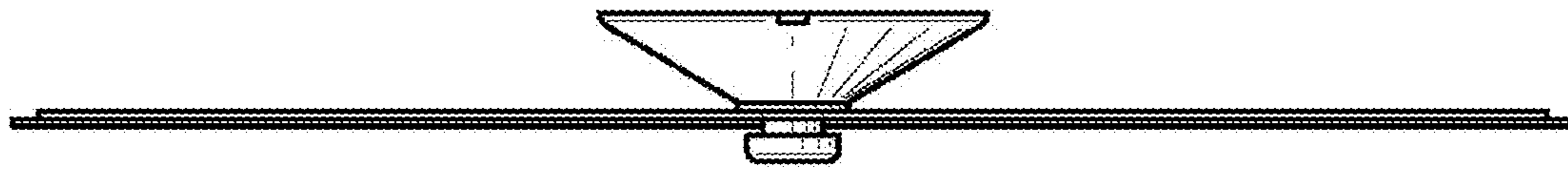

FIG. 3

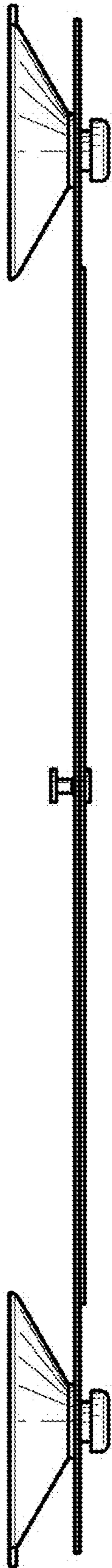

FIG. 5

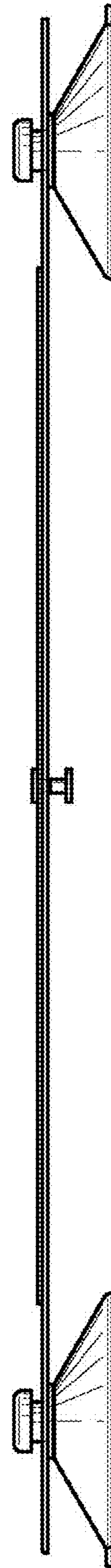

FIG. 6

FIG. 7

