



US00D895473S

(12) **United States Design Patent**  
**Javaheri**

(10) **Patent No.:** **US D895,473 S**  
(45) **Date of Patent:** **\*\* Sep. 8, 2020**

- (54) **RING**
  - (71) Applicant: **Amden Jewelry, Inc.**, Los Angeles, CA (US)
  - (72) Inventor: **Pat Javaheri**, Los Angeles, CA (US)
  - (73) Assignee: **AMDEN JEWELRY, INC.**, Los Angeles, CA (US)
  - (\*\*) Term: **15 Years**
  - (21) Appl. No.: **29/689,919**
  - (22) Filed: **May 2, 2019**
  - (51) **LOC (12) Cl.** ..... **11-01**
  - (52) **U.S. Cl.**  
USPC ..... **D11/34**
  - (58) **Field of Classification Search**  
USPC ..... D11/1-39, 40-42, 43, 79, 44-45, 85, 91  
CPC ..... A44C 9/00; A44C 9/0007; A44C 9/0015;  
A44C 9/0023; A44C 9/003; A44C 9/0038; A44C 9/0046; A44C 9/0053;  
A44C 9/0061; A44C 9/0069; A44C 9/0076; A44C 9/0084; A44C 9/0092;  
A44C 9/02
- See application file for complete search history.

D267,482 S *	1/1983	Barr	.....	D11/28
D327,660 S *	7/1992	Waugh	.....	D11/26
D463,752 S *	10/2002	Ambar	.....	D11/34
D602,804 S *	10/2009	Moody	.....	D11/34
D675,952 S *	2/2013	Dholakiya	.....	D11/34
D808,850 S *	1/2018	Silvestri	.....	D11/34

**OTHER PUBLICATIONS**

Macy's Cubic Zirconia Square Halo Twist Ring in Sterling Silver, [online], [site visited Apr. 29, 2020]. Retrieved from url:https://www.macys.com/shop/product/cubic-zirconia-square-halo-twist-ring-in-sterling-silver?ID=8504157&CategoryID=21176 (Year: 2020).\*

Bypass Semi-Mount Halo Style Emerald Cut, no date available, [online], [site visited Apr. 29, 2020]. Retrieved from url: https://www.setrany.com/products/engagement-ring-sro84762 (Year: 2020).\*

\* cited by examiner

*Primary Examiner* — Michelle E. Wilson  
*Assistant Examiner* — Tracey J Bell  
 (74) *Attorney, Agent, or Firm* — Womble Bond Dickinson (US) LLP

(57) **CLAIM**

The ornamental design for a ring, as shown and described.

**DESCRIPTION**

FIG. 1 is a front, side perspective view of my ring.  
 FIG. 2 is a bottom, side perspective view thereof.  
 FIG. 3 is a front elevation view thereof.  
 FIG. 4 is a rear elevation view thereof.  
 FIG. 5 is a left side elevation view thereof.  
 FIG. 6 is a right side elevation view thereof.  
 FIG. 7 is a top plan view thereof; and,  
 FIG. 8 is a bottom plan view thereof.  
 The broken lines are provided to show the environment related to the claimed design, but form no part of the claim.

**1 Claim, 8 Drawing Sheets**

(56) **References Cited**  
 U.S. PATENT DOCUMENTS

1,877,442 A *	9/1932	Armstrong	.....	A44C 17/04 63/15
D133,398 S *	8/1942	Boucher	.....	D11/34
D149,709 S *	5/1948	Untermeyer	.....	D11/34
2,763,140 A *	9/1956	Lutrario	.....	A44C 9/00 63/15.7
2,764,001 A *	9/1956	Lutrario	.....	A44C 9/00 63/15.7
D195,692 S *	7/1963	Roberts	.....	D11/39
D199,500 S *	11/1964	Hazelquist	.....	D11/36

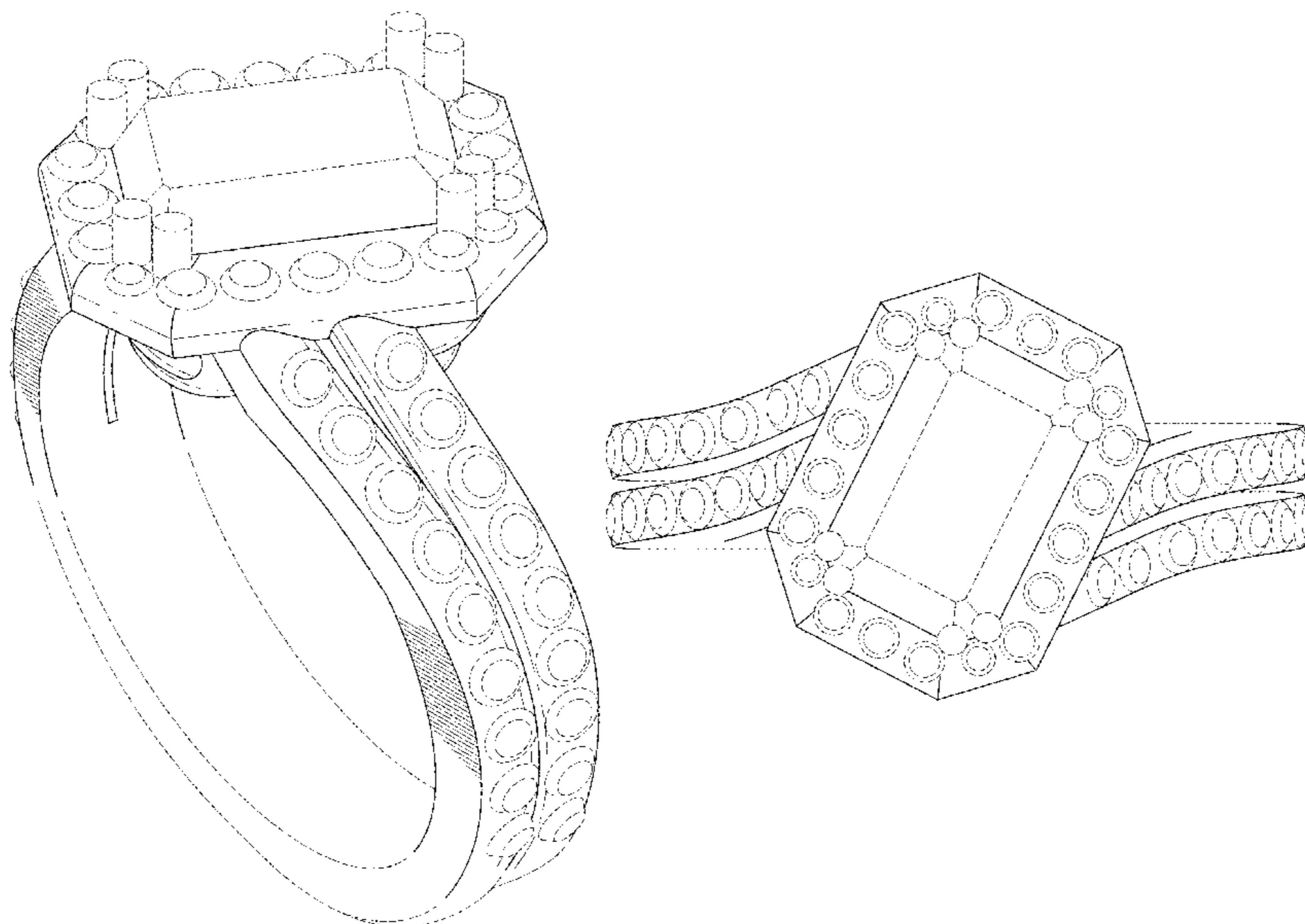

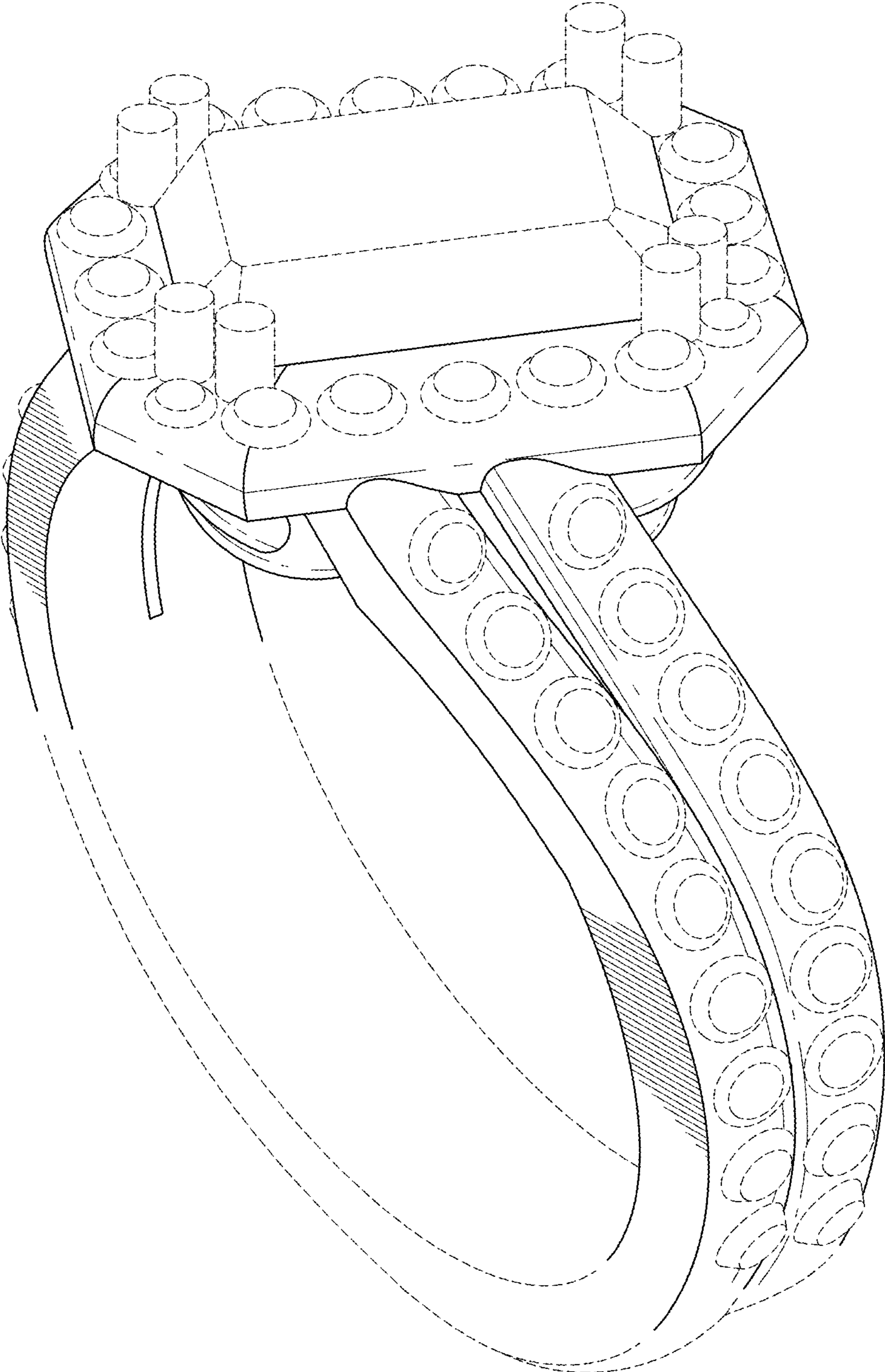

*FIG. 1*

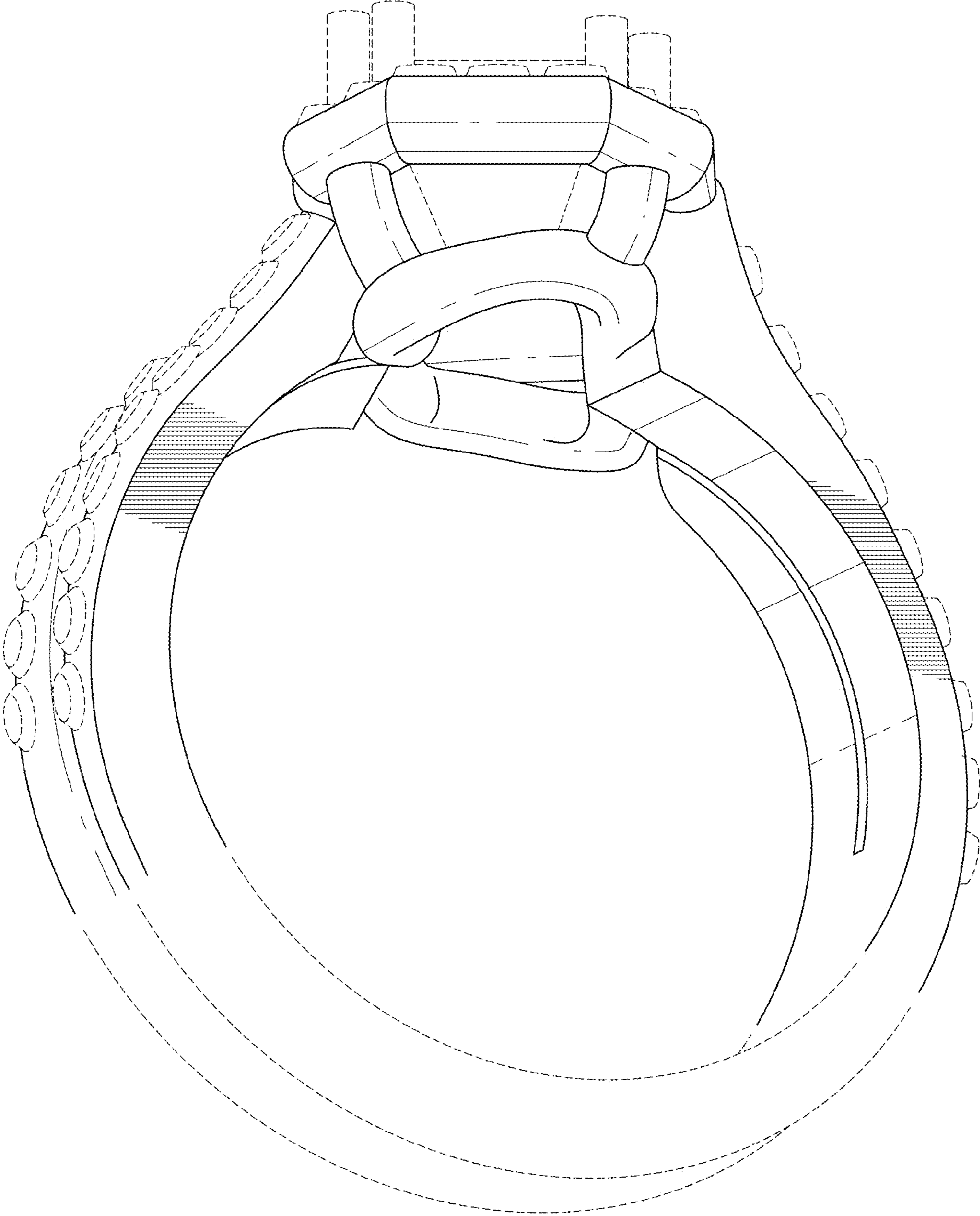
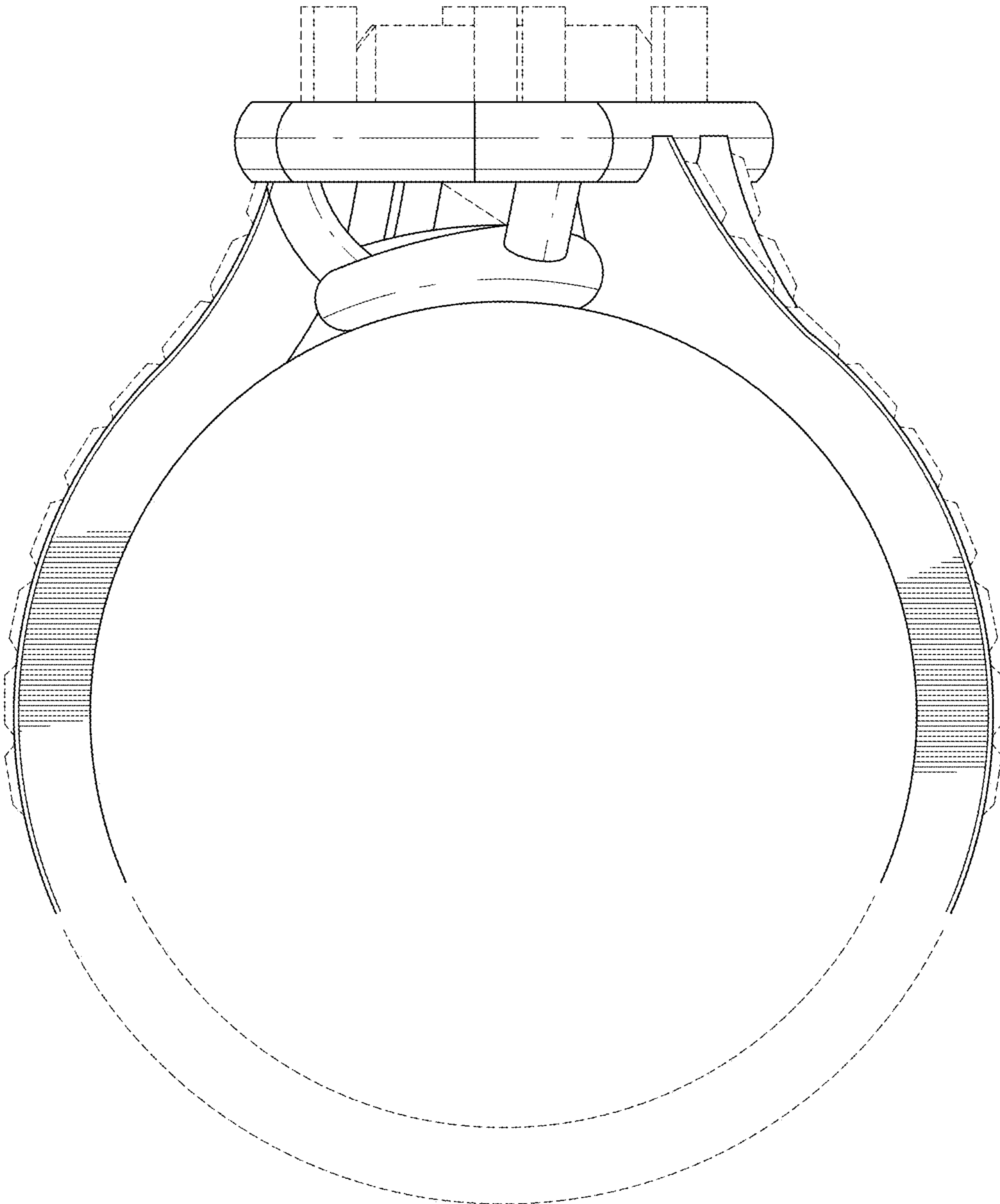
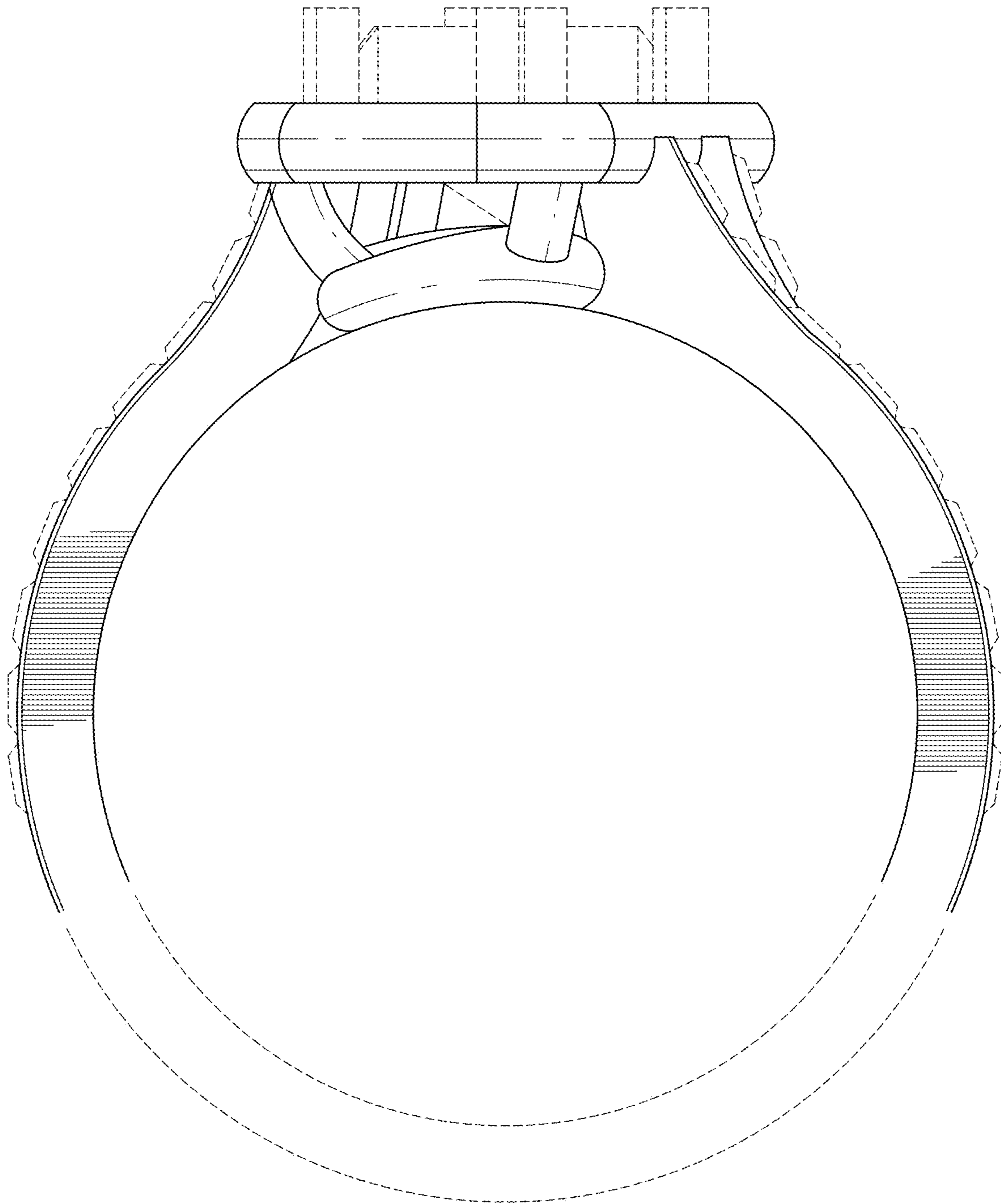

FIG. 2



*FIG. 3*



*FIG. 4*

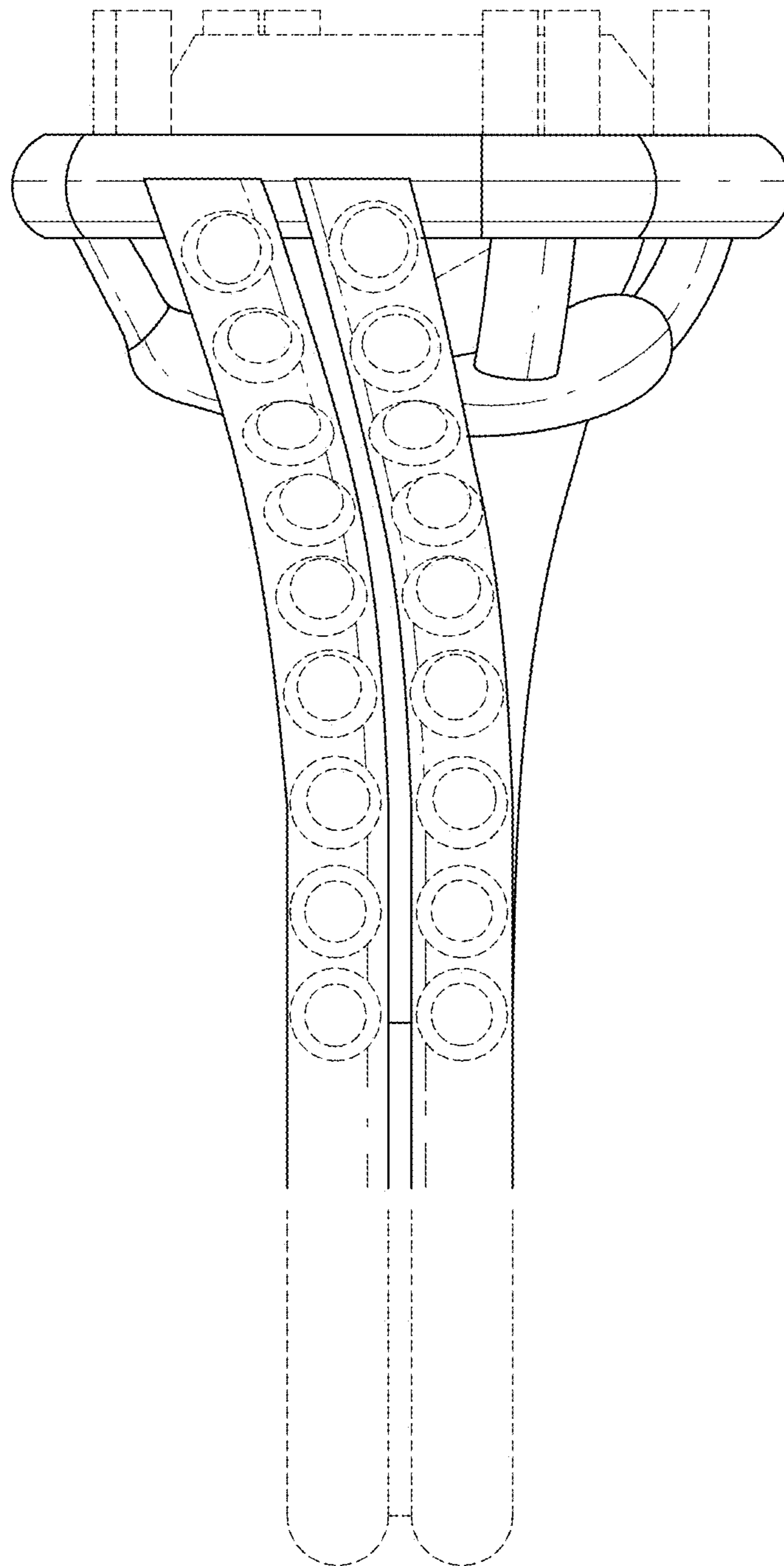

*FIG. 5*

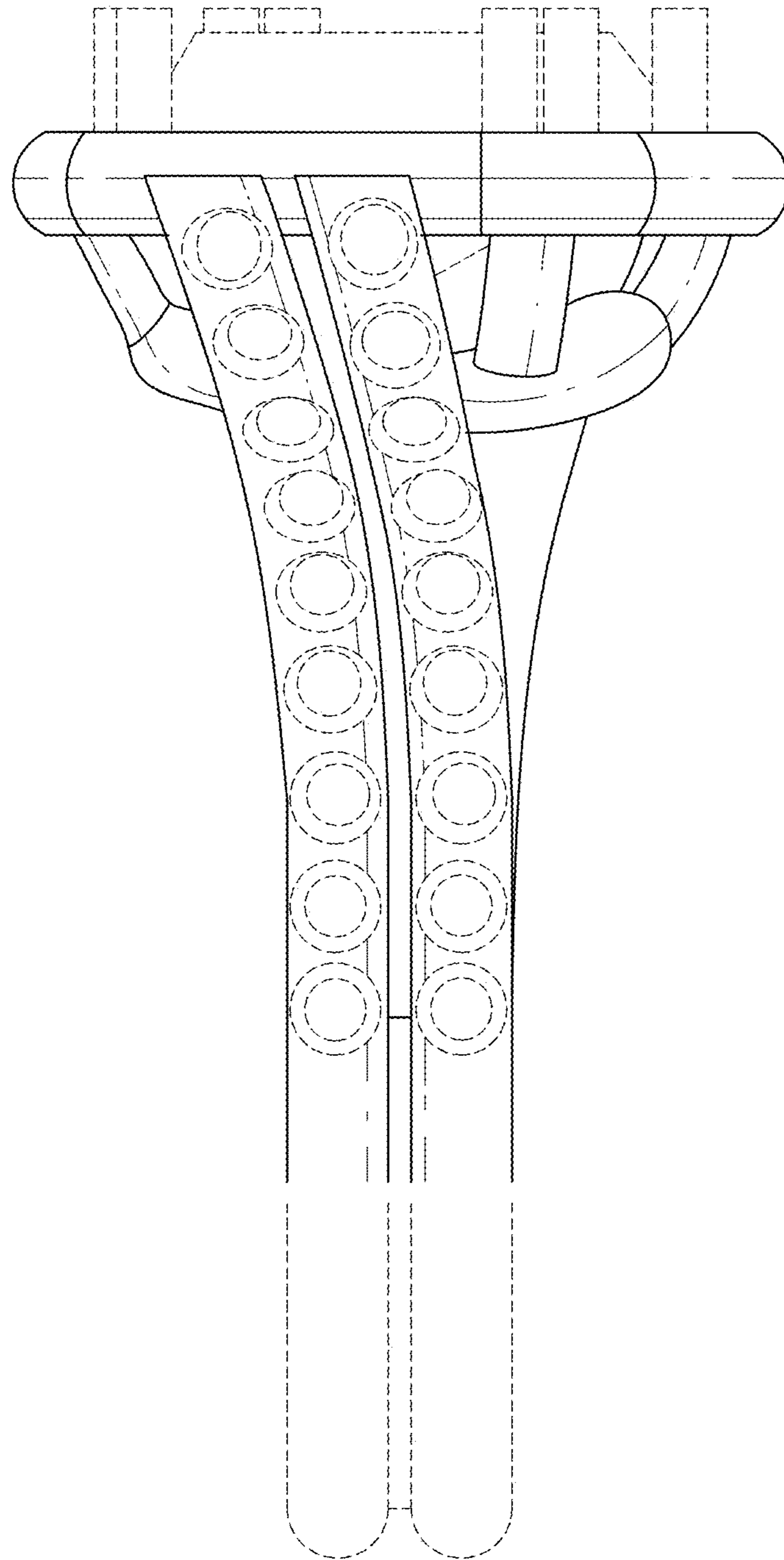

*FIG. 6*

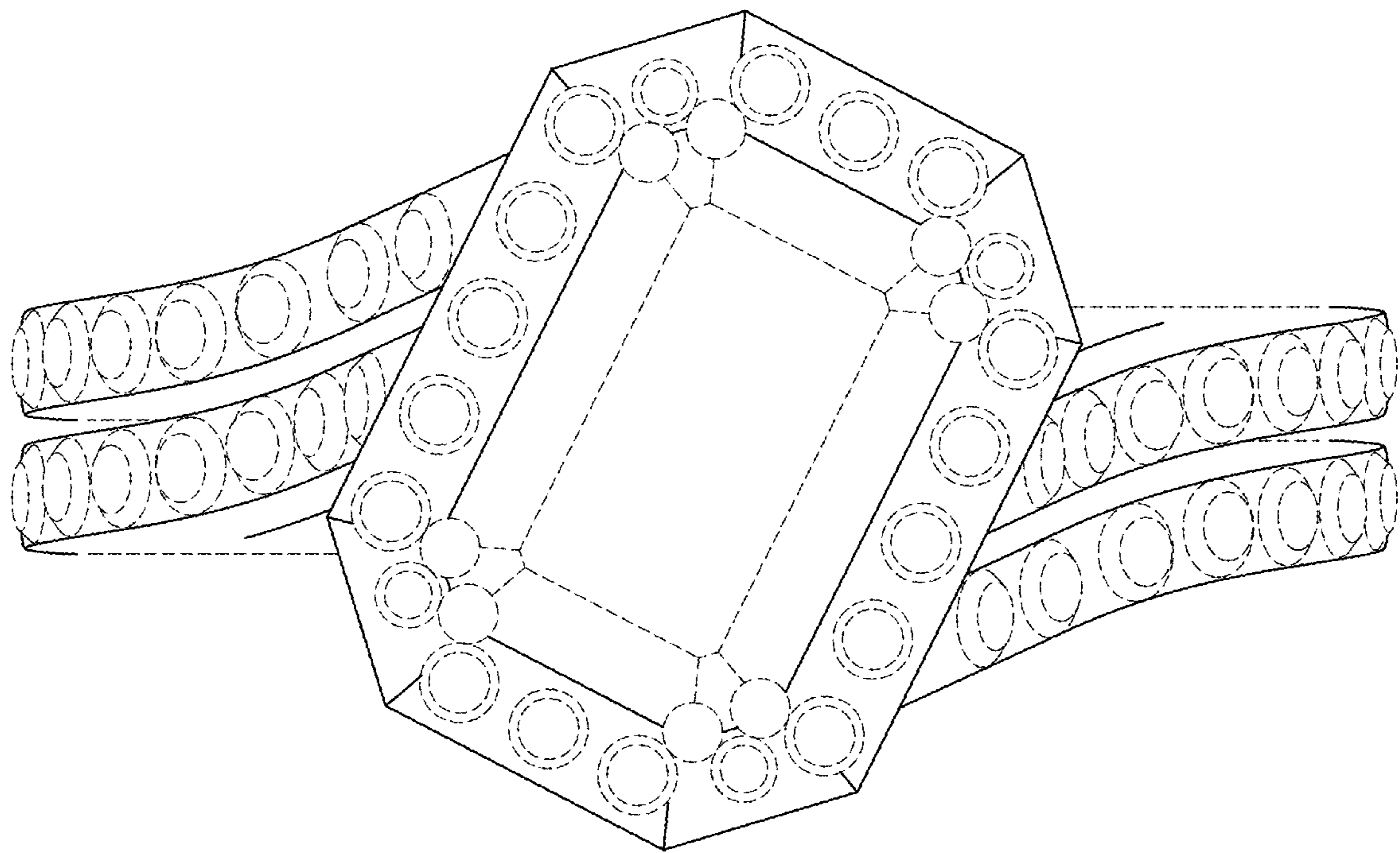

*FIG. 7*



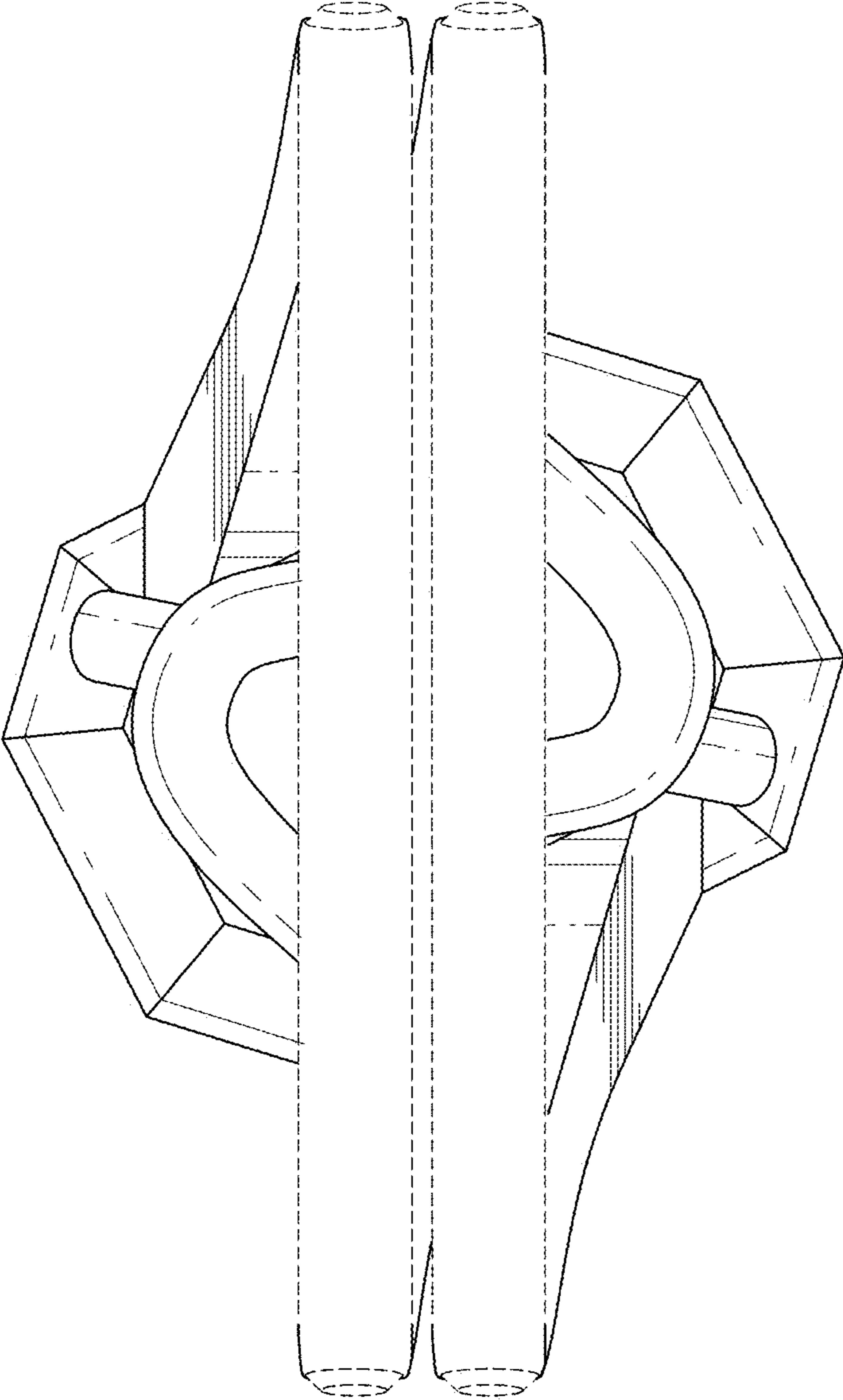

FIG. 8