

US00D895469S

(12) **United States Design Patent** (10) **Patent No.:** **US D895,469 S**
Gurung (45) **Date of Patent:** **** Sep. 8, 2020**

(54) **JEWELLERY**

(71) Applicant: **TASAKI & Co., Ltd.**, Kobe (JP)
(72) Inventor: **Prabal Gurung**, New York, NY (US)
(73) Assignee: **TASAKI & Co., Ltd.**, Kobe (JP)
(**) Term: **15 Years**

(21) Appl. No.: **35/507,205**

(22) Filed: **Feb. 6, 2019**

(80) **Hague Agreement Data**

Int. Filing Date: **Feb. 6, 2019**
Int. Reg. No.: **DM/201203**
Int. Reg. Date: **Feb. 6, 2019**
Int. Reg. Pub. Date: **Aug. 9, 2019**

(51) **LOC (12) Cl.** **11-01**

(52) **U.S. Cl.**
USPC **D11/1; D11/4; D11/43; D11/79**

(58) **Field of Classification Search**
USPC **D11/1-39, 40-42, 43, 79, 44-45, 85, 91**
CPC **A44C 9/00; A44C 9/0007; A44C 9/0015;**
A44C 9/0023; A44C 9/003; A44C
9/0038; A44C 9/0046; A44C 9/0053;
A44C 9/0061;

(Continued)

(56) **References Cited**

U.S. PATENT DOCUMENTS

D161,566 S * 1/1951 Boucher D11/5
D377,461 S * 1/1997 Kloppenburg, Jr. D11/44

(Continued)

FOREIGN PATENT DOCUMENTS

CN 300911879 * 6/2017
CN 304292062 * 9/2017

(Continued)

OTHER PUBLICATIONS

Tasaki Elysium Necklace, Pendant, Bracelet, no date available, [online], [site visited Apr. 28, 2020]. Retrieved from url:https://www.tasaki-global.com/jewellery/atelier/tasaki_atelier/elysium/PI-16875-18KWG/ (Year: 2020).*

(Continued)

Primary Examiner — Michelle E. Wilson

Assistant Examiner — Tracey J Bell

(74) *Attorney, Agent, or Firm* — Rankin, Hill & Clark LLP

(57) **CLAIM**

The ornamental design for a jewellery, as shown and described.

DESCRIPTION

- 1.-3. Jewellery
- 1.1 : Perspective
- 1.2 : Front
- 1.3 : Back
- 1.4 : Right
- 1.5 : Left
- 1.6 : Top
- 1.7 : Bottom
- 2.1 : Perspective
- 2.2 : Perspective
- 2.3 : Front
- 2.4 : Back
- 2.5 : Right
- 2.6 : Left
- 2.7 : Top
- 2.8 : Bottom
- 3.1 : Perspective
- 3.2 : Perspective
- 3.3 : Front
- 3.4 : Back
- 3.5 : Right
- 3.6 : Left
- 3.7 : Top
- 3.8 : Bottom

(Continued)

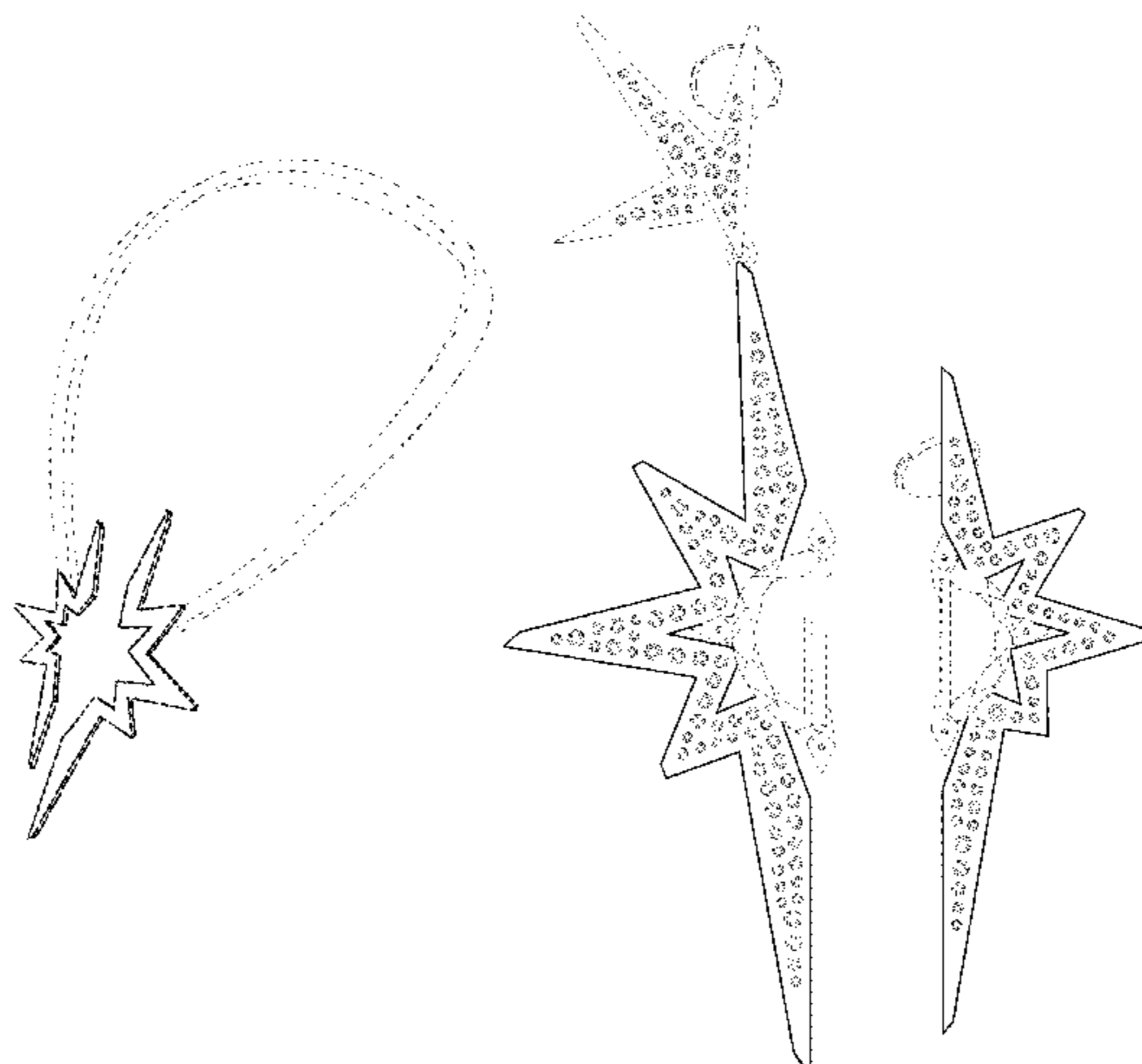

The broken lines depict portions of the jewellery that form no part of the claimed design.

1 Claim, 23 Drawing Sheets

D821,910 S *	7/2018	Stern	D11/34
D821,911 S *	7/2018	Stern	D11/79
D822,527 S *	7/2018	Stern	D11/4
D822,531 S *	7/2018	Stern	D11/40
D822,532 S *	7/2018	Stern	D11/40
D826,078 S *	8/2018	Stern	D11/26

(58) Field of Classification Search

CPC .. A44C 9/0069; A44C 9/0076; A44C 9/0084;
A44C 9/0092; A44C 9/02; A44C 15/005;
A44C 7/00

See application file for complete search history.

FOREIGN PATENT DOCUMENTS

CN	305097530	*	4/2019
JP	D1580367	*	7/2017
WO	WOD092576-017	*	9/2016

(56)

References Cited

U.S. PATENT DOCUMENTS

D485,515 S *	1/2004	Price	D12/114
D628,804 S *	12/2010	Gonzalez	D3/318
D780,027 S *	2/2017	Stern	D11/34
D811,928 S *	3/2018	Stern	D11/40
D815,556 S *	4/2018	Stern	D11/40

OTHER PUBLICATIONS

Vouge During Haute Couture Week in Paris, Tina Isaac-Goize, Jan. 31, 2017, [online], [site visited Apr. 30, 2020]. Retrieved from url:<https://www.vogue.com/article/de-beers-louis-vuitton-tasaki-solange-azagury-partridge> (Year: 2017).*

* cited by examiner

1.1
Perspective

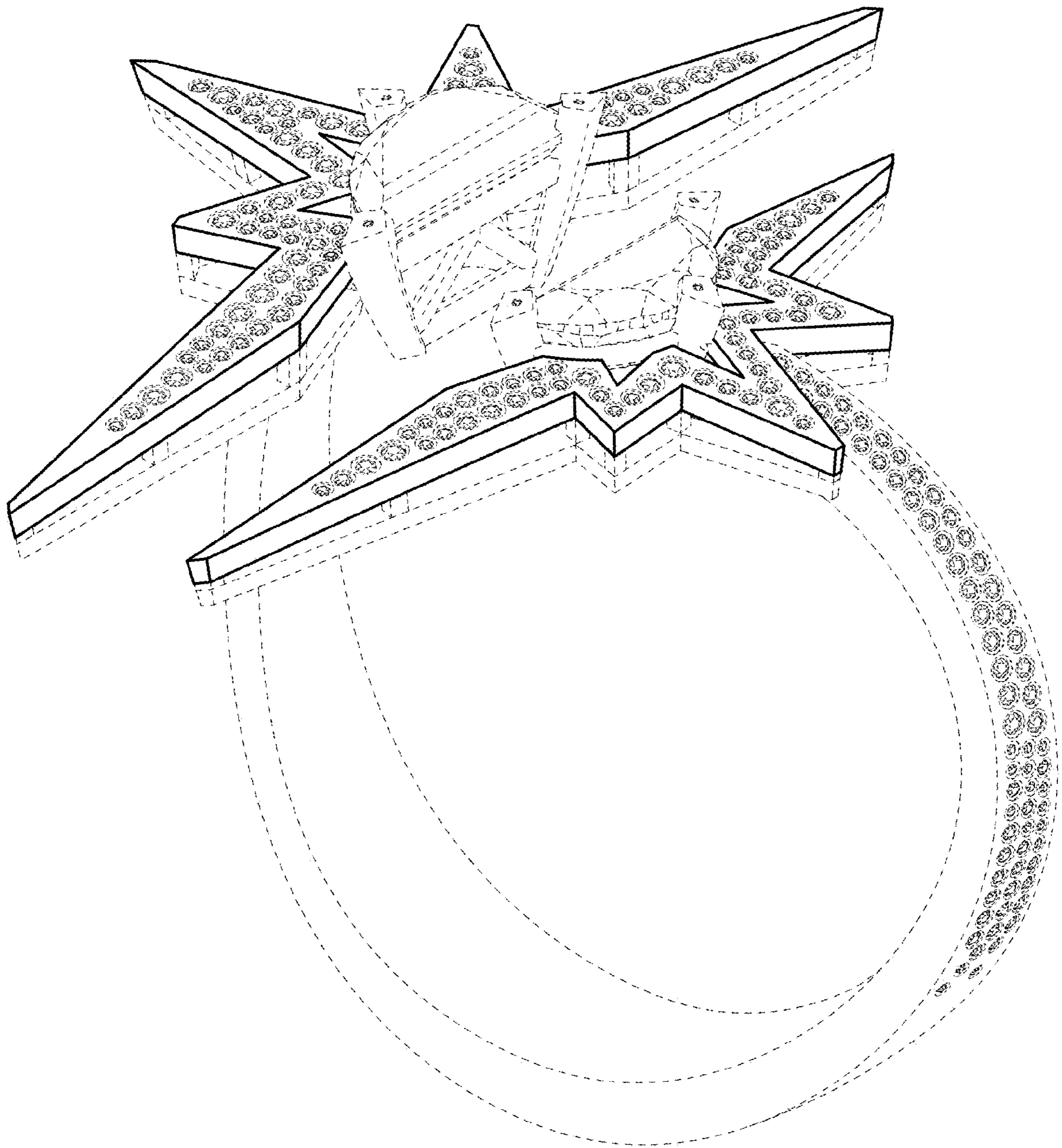

1.2
Front

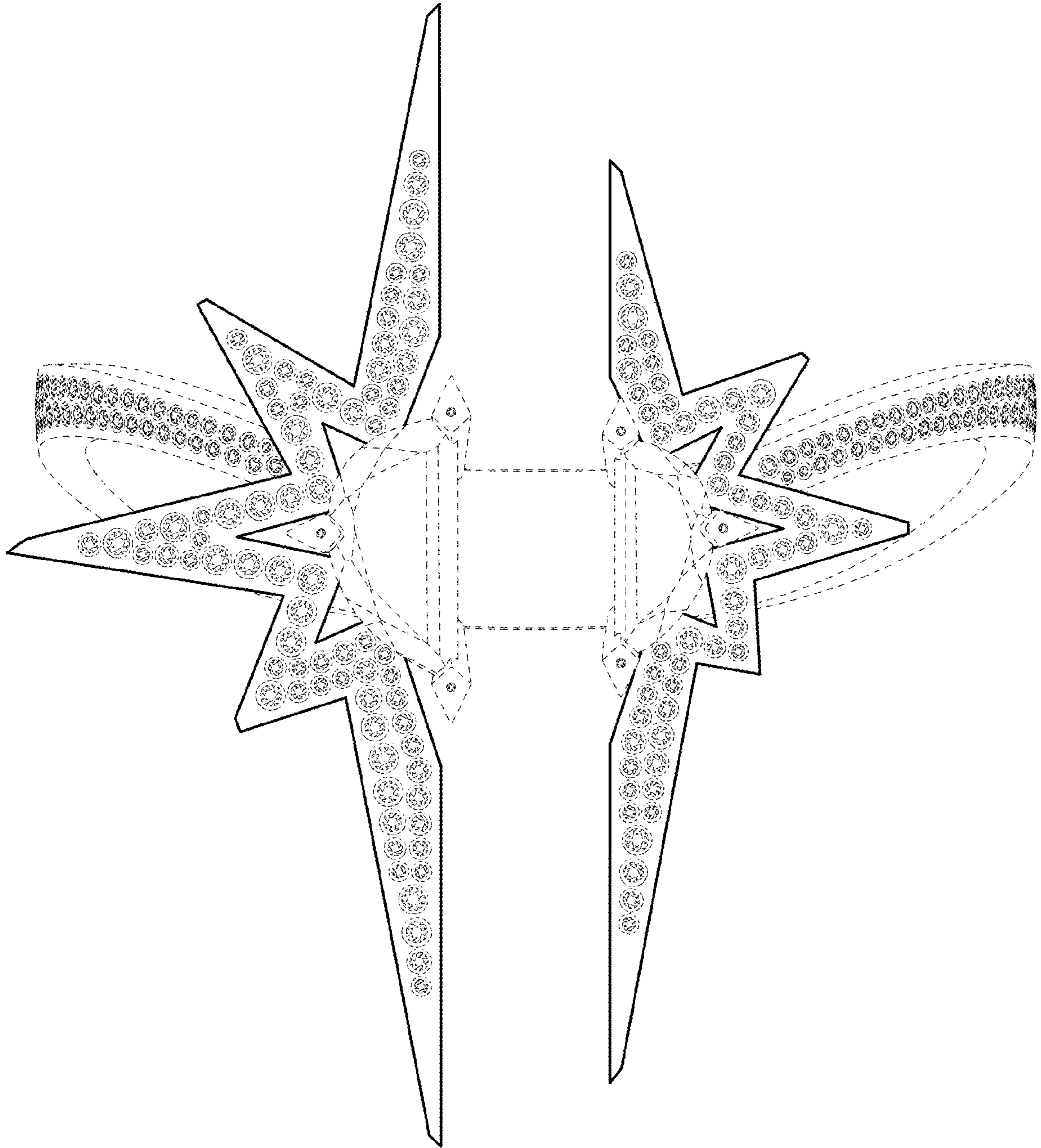

1.3
Back

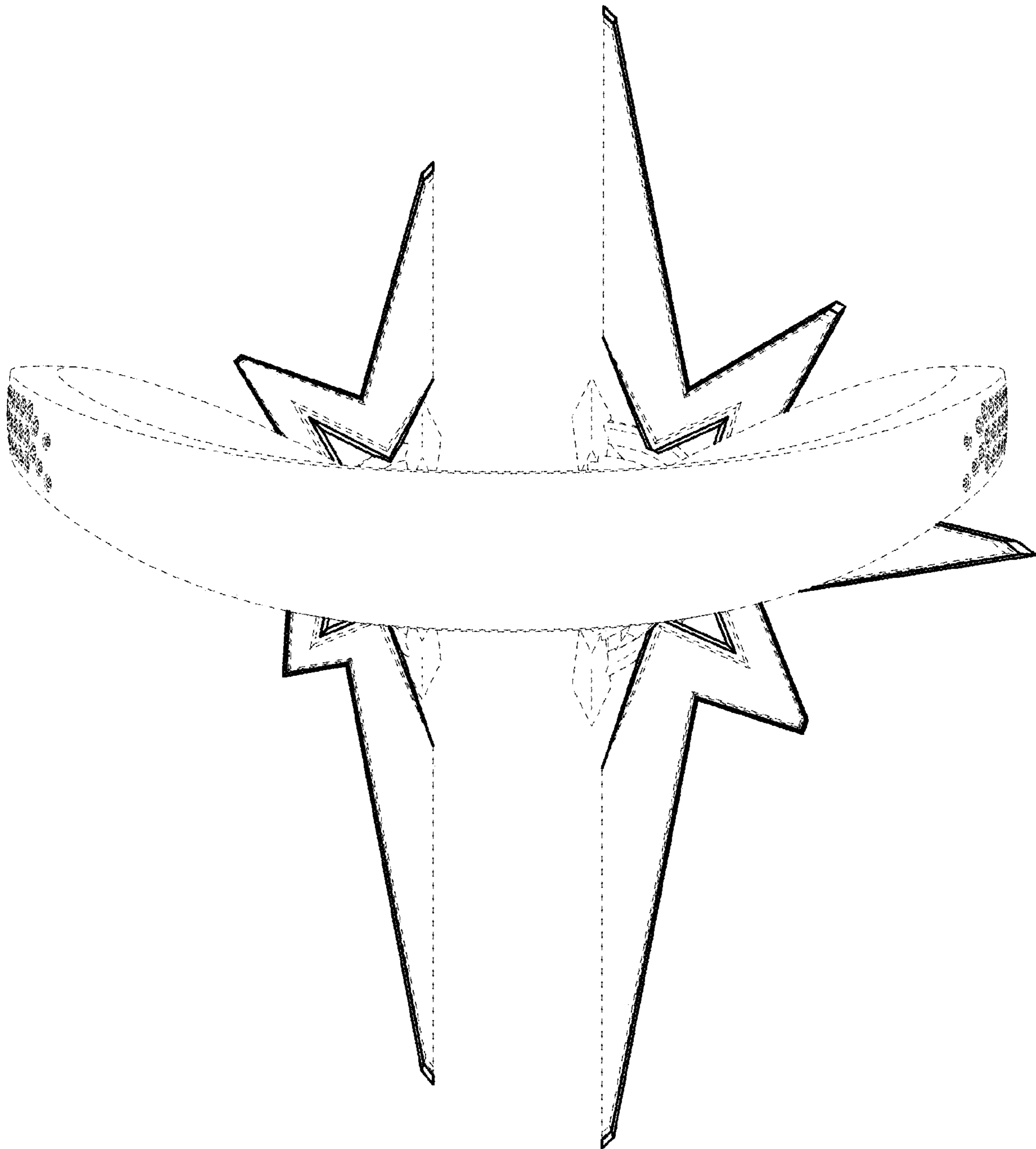

1.4
Right

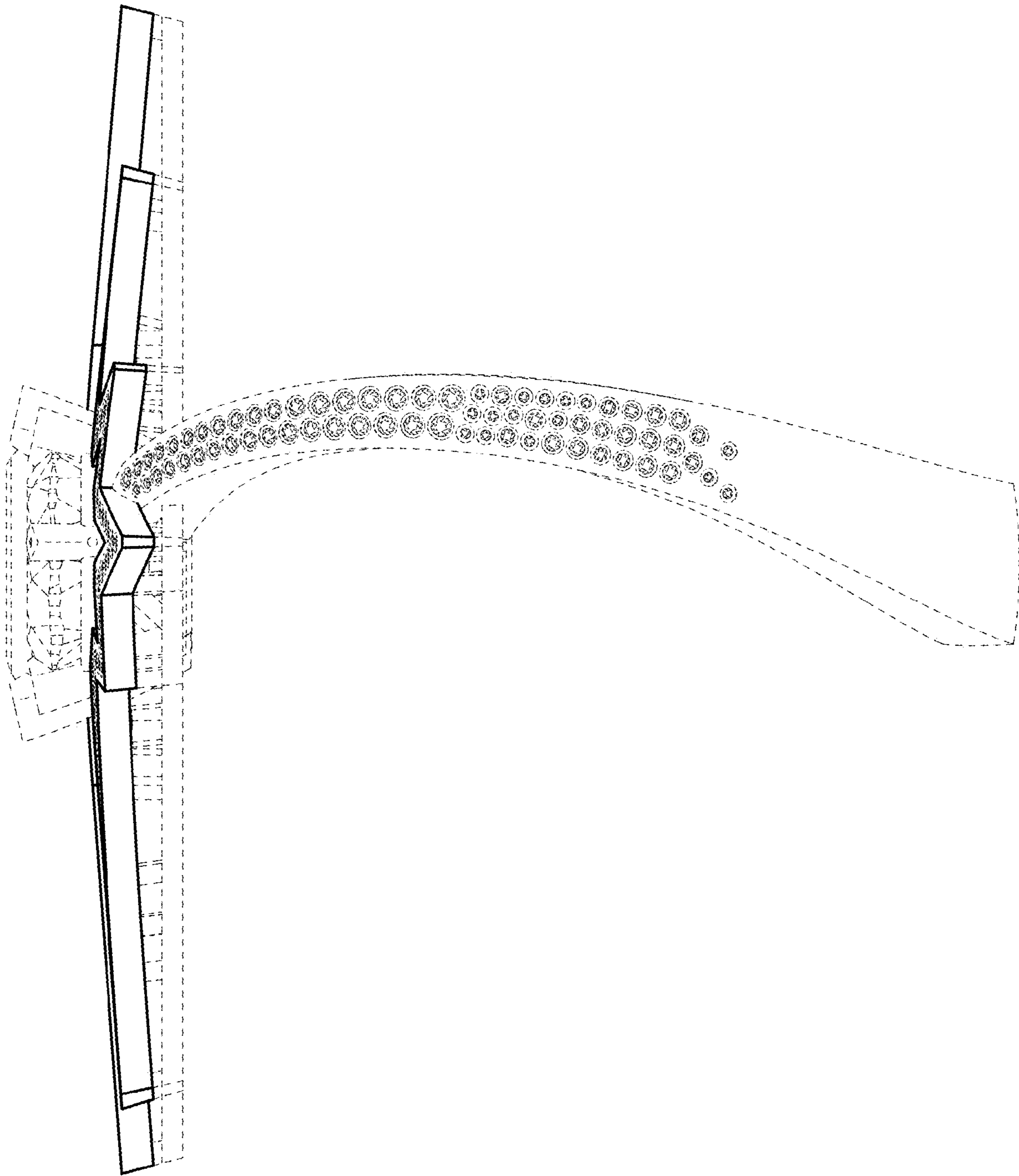

1.5
Left

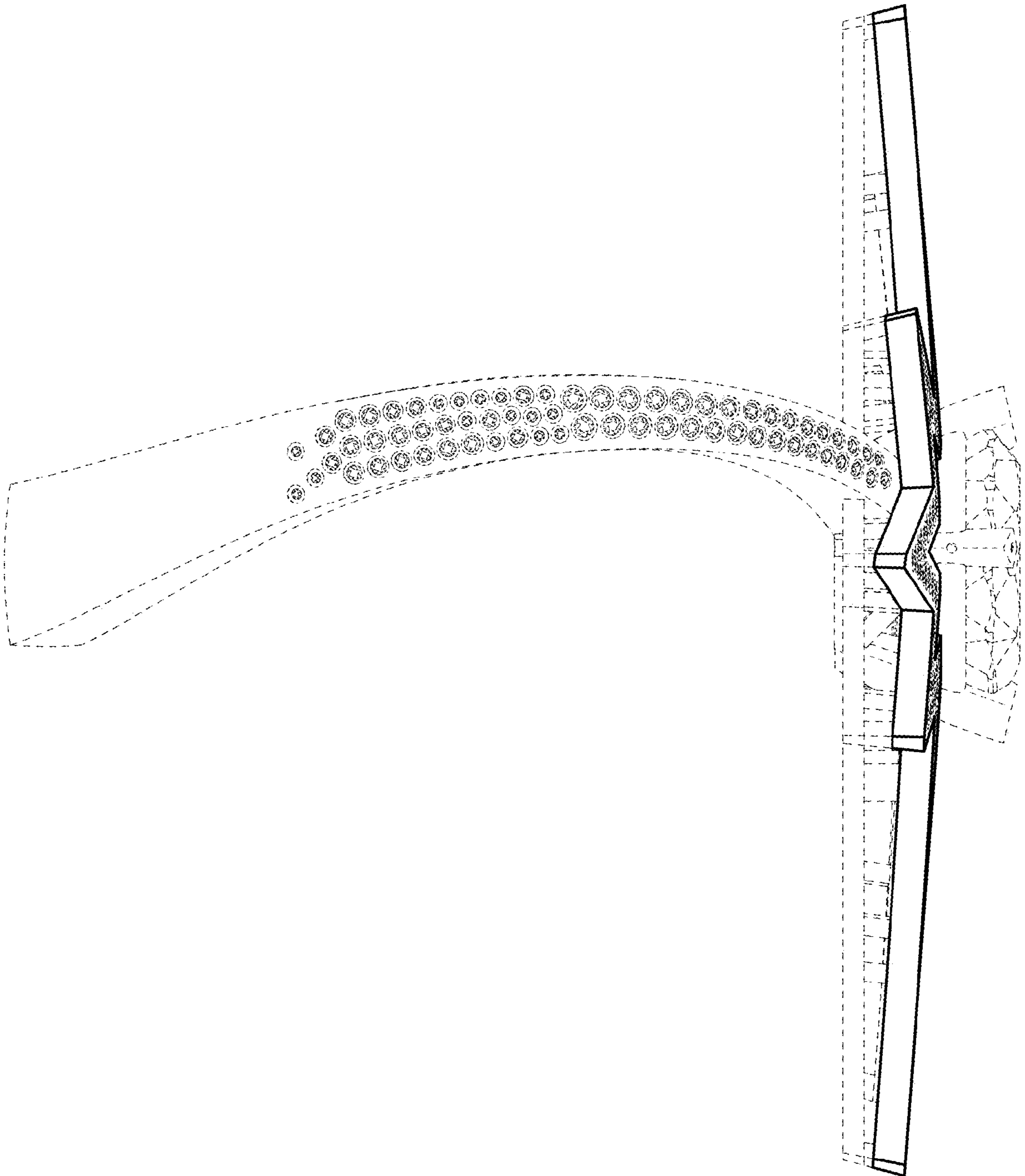

1.6
Top

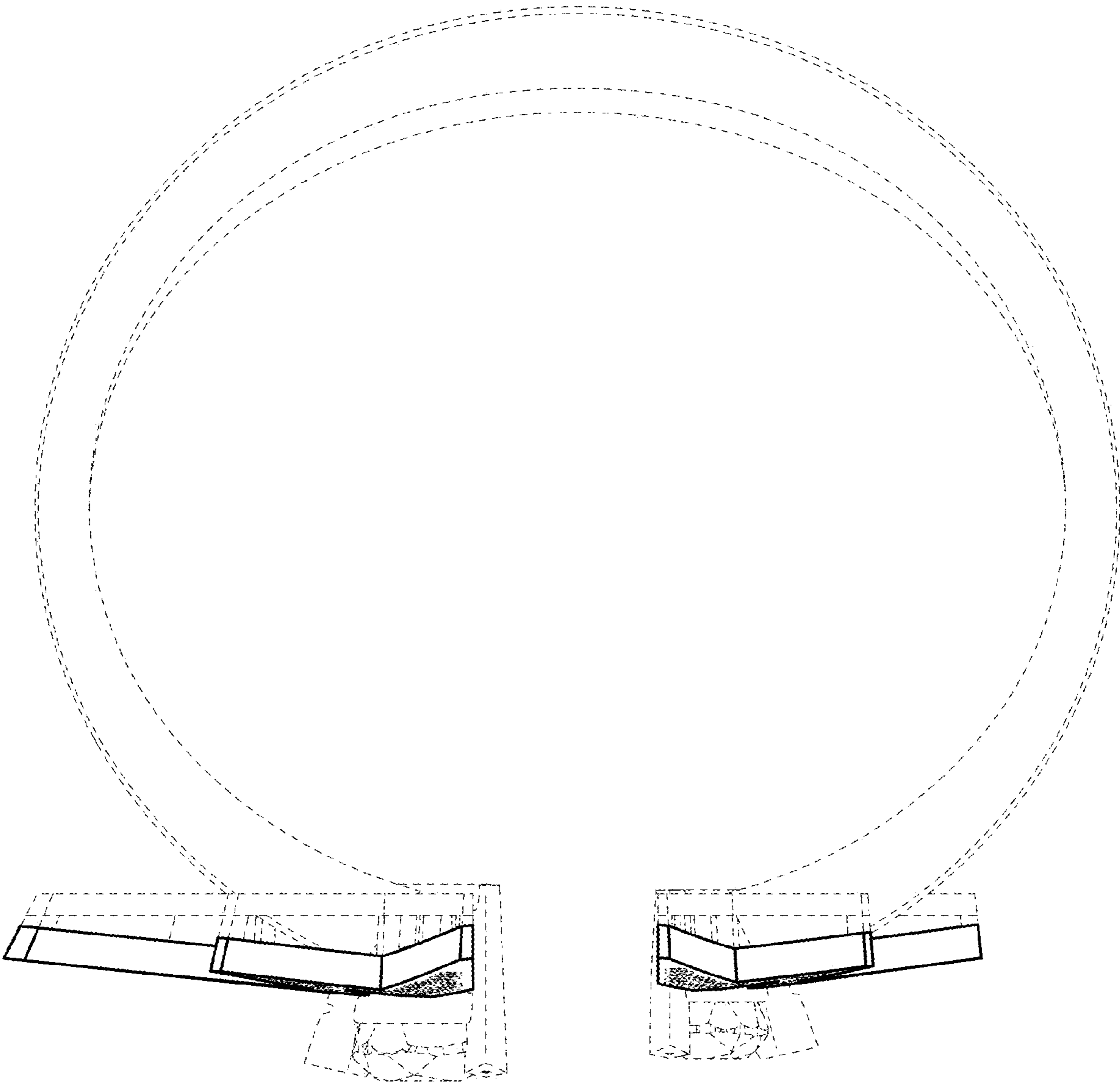

1.7
Bottom

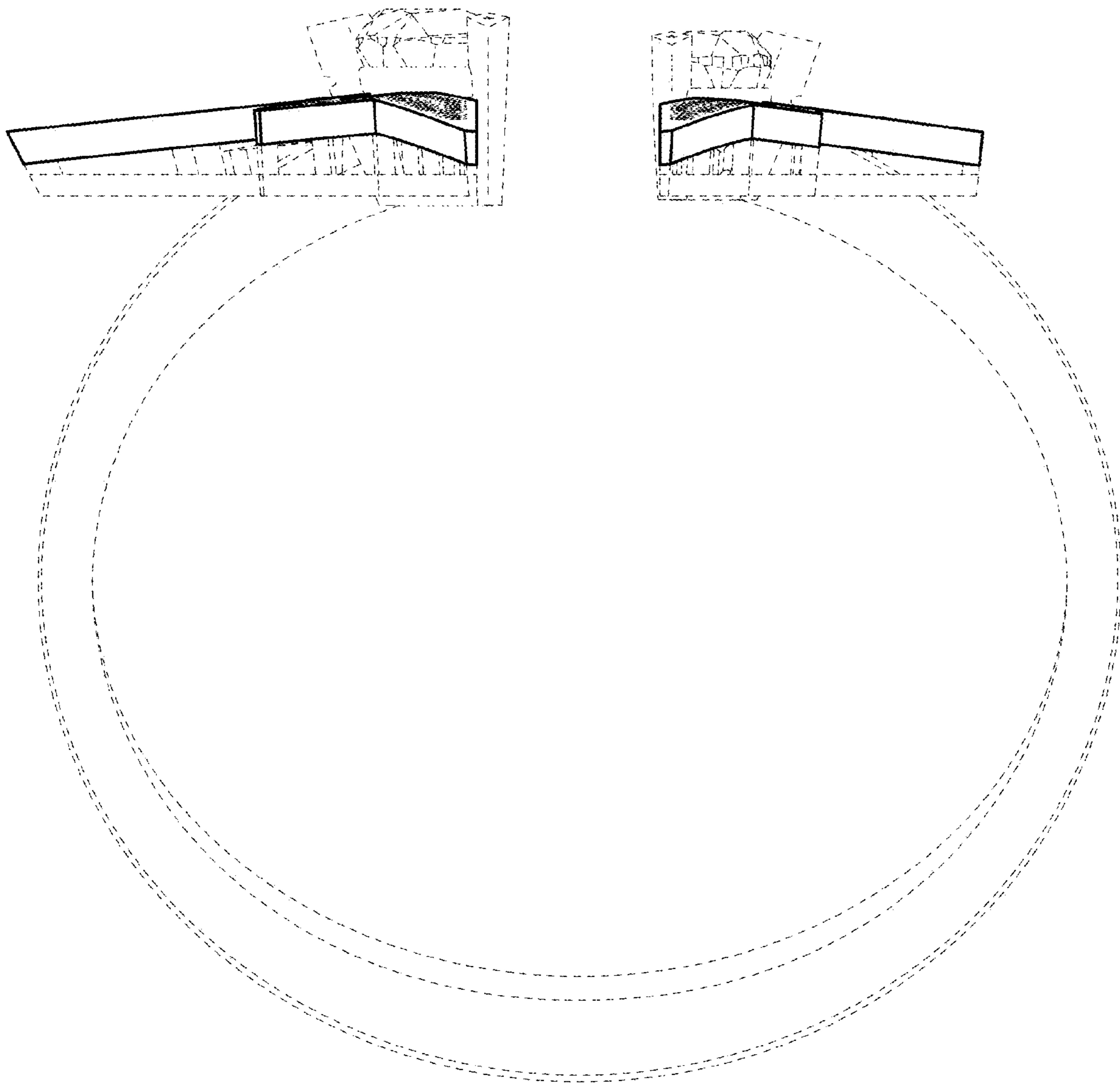

2.1

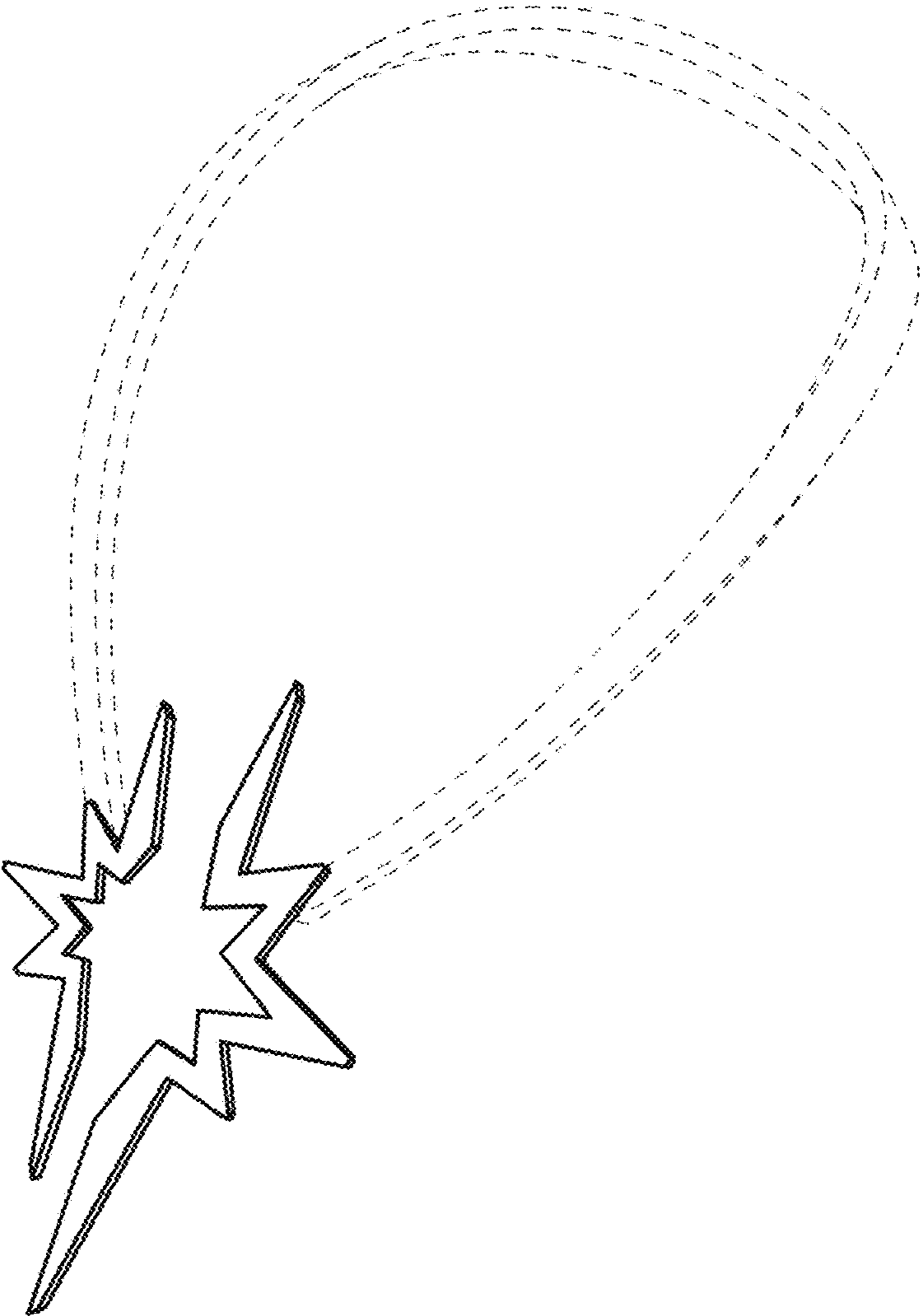

2.2



2.3

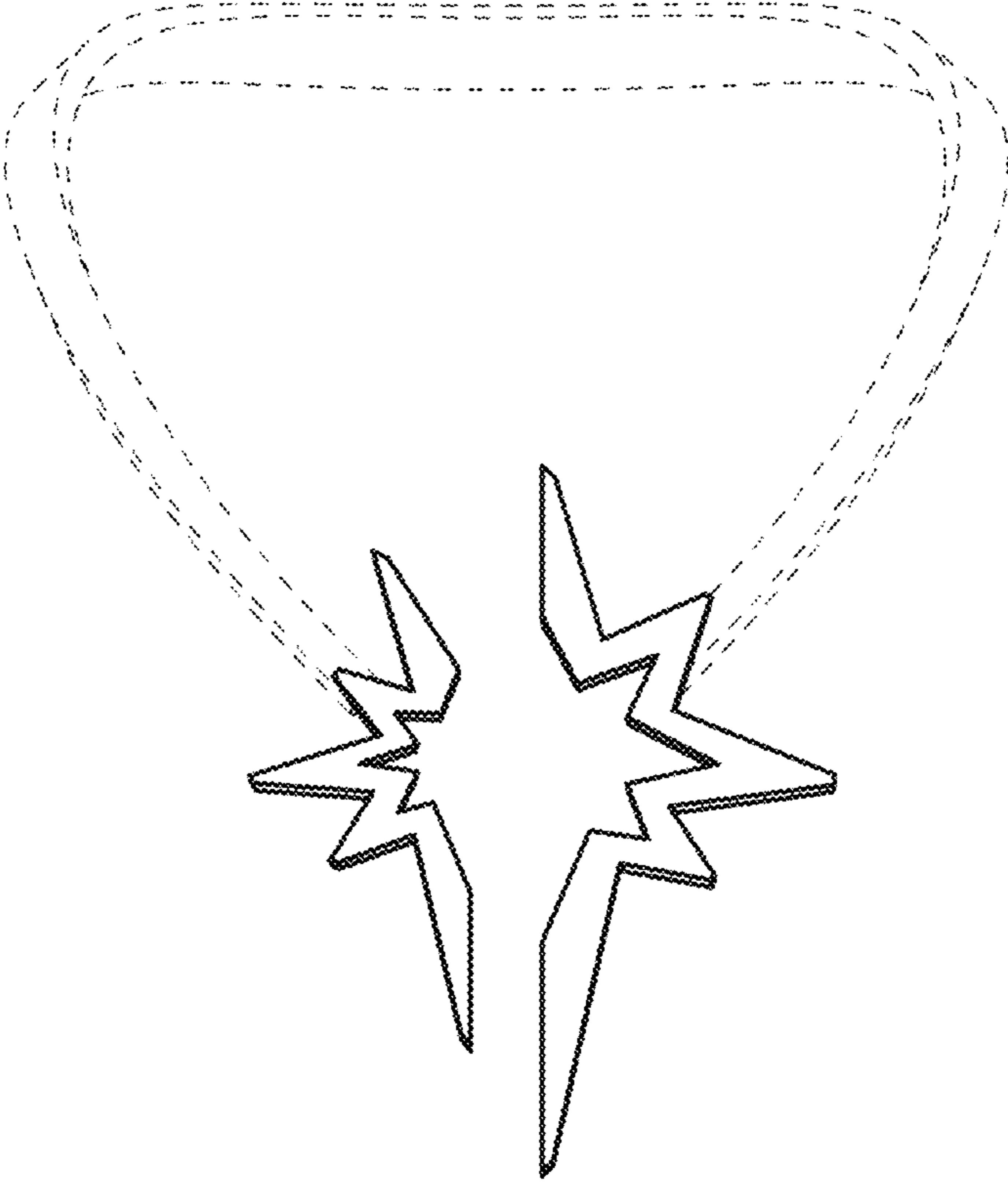

2.4

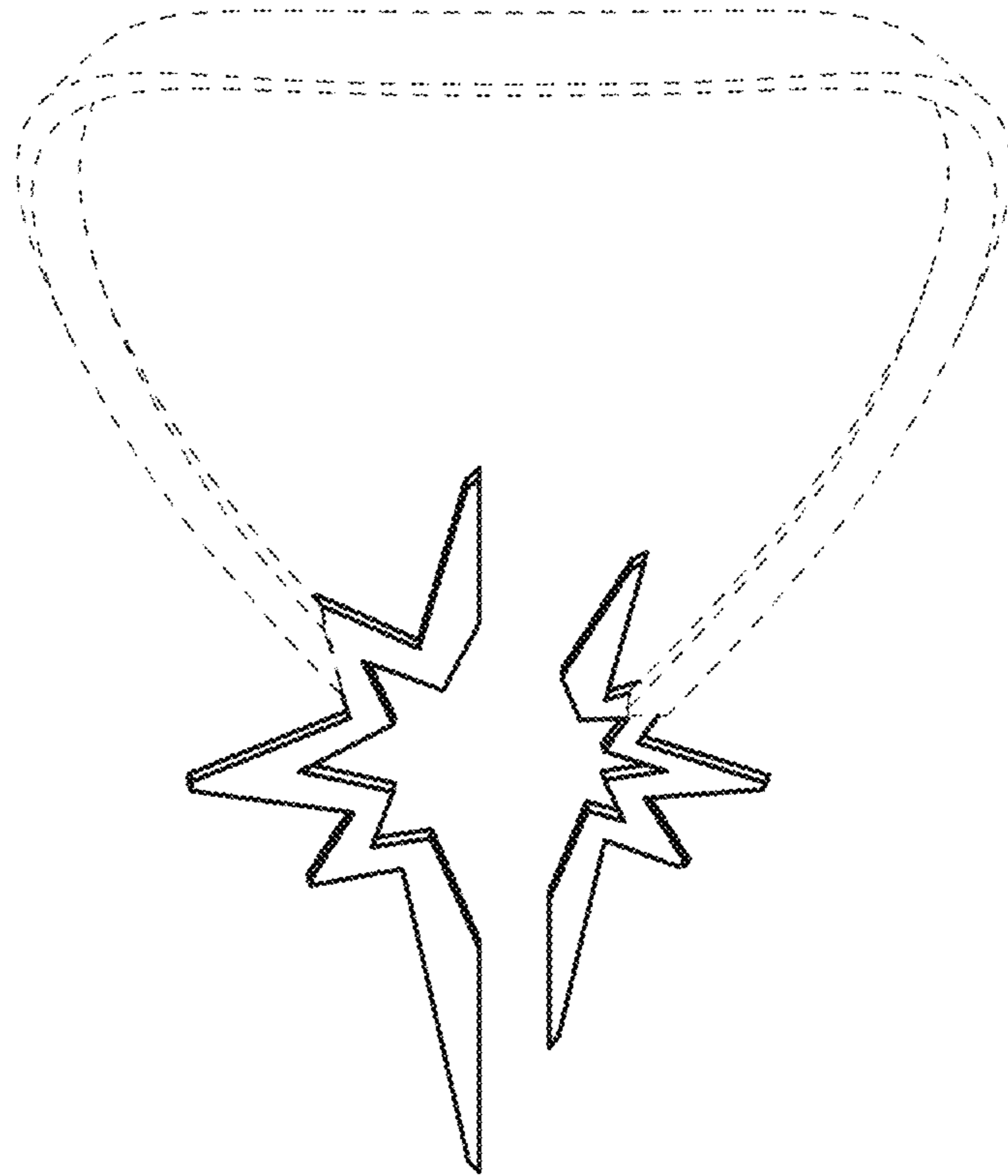

2.5

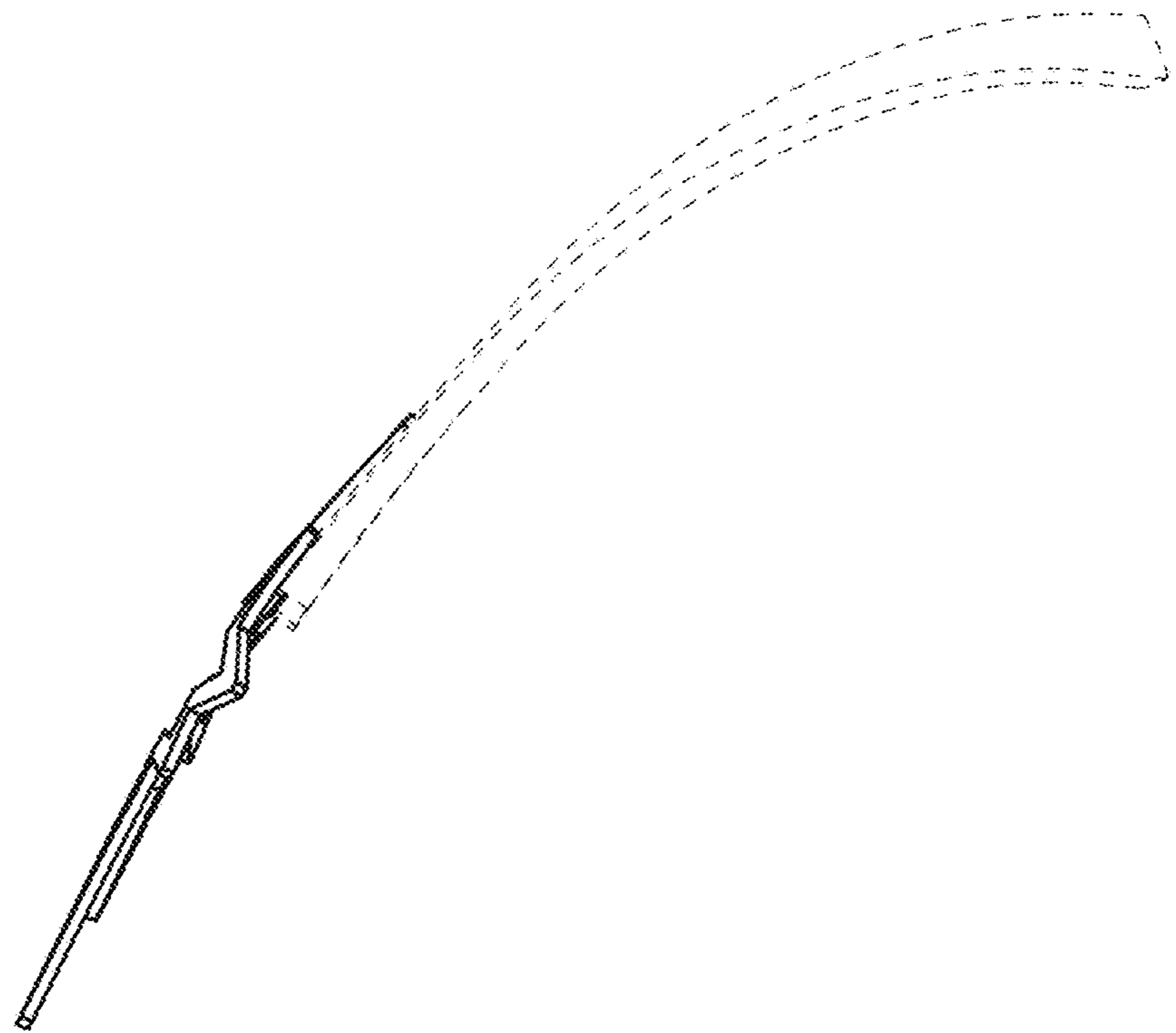

2.6

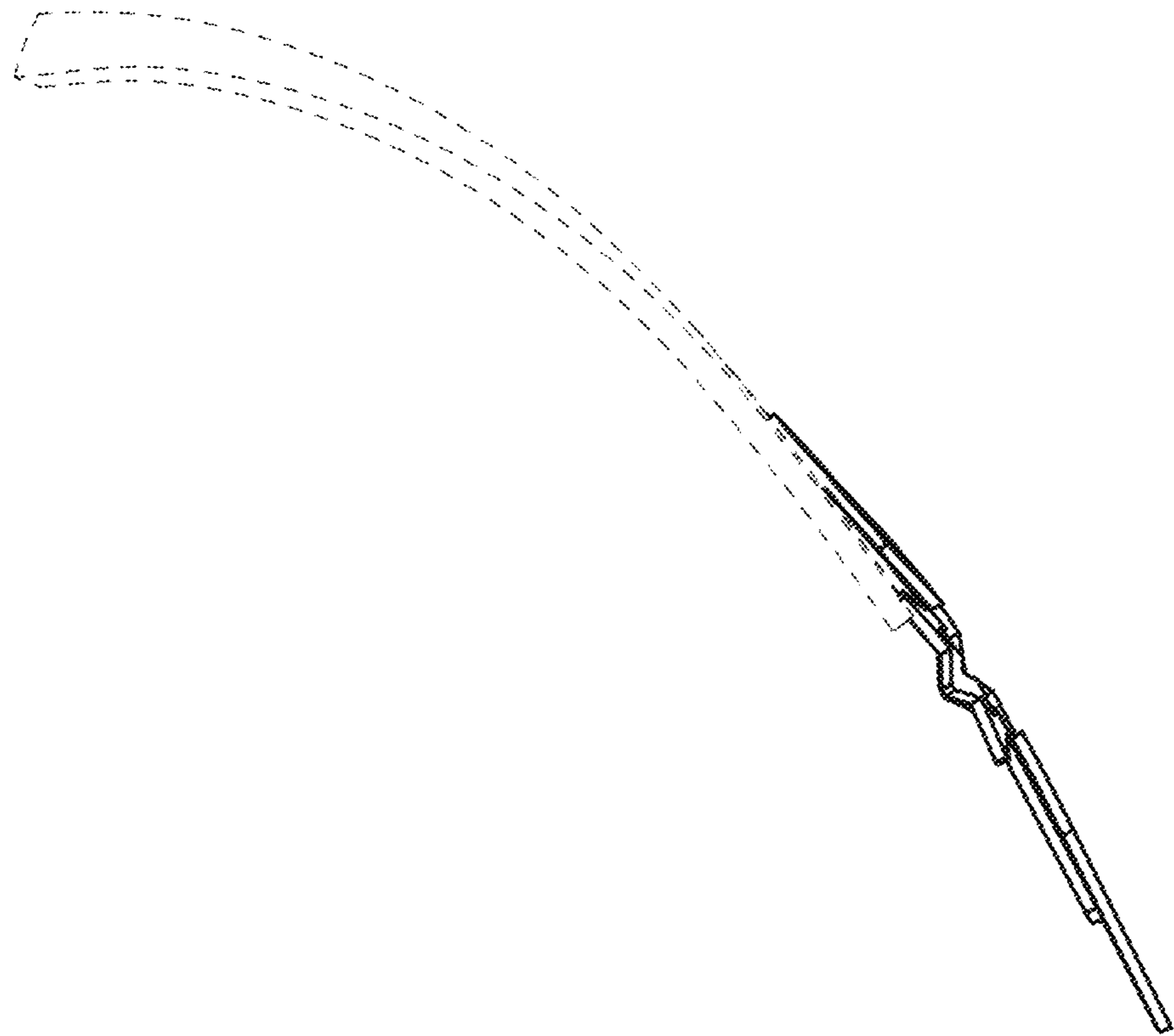

2.7

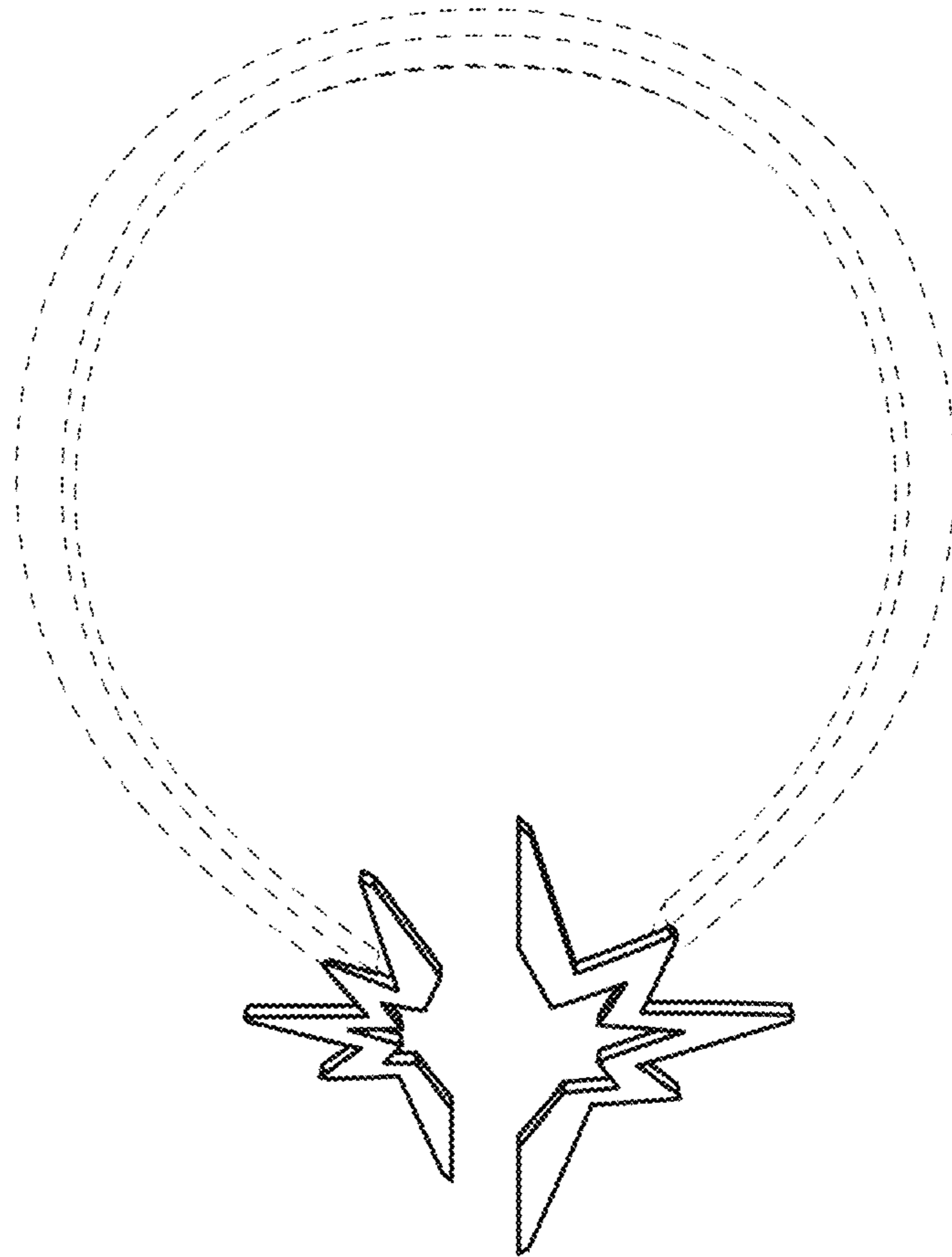

2.8

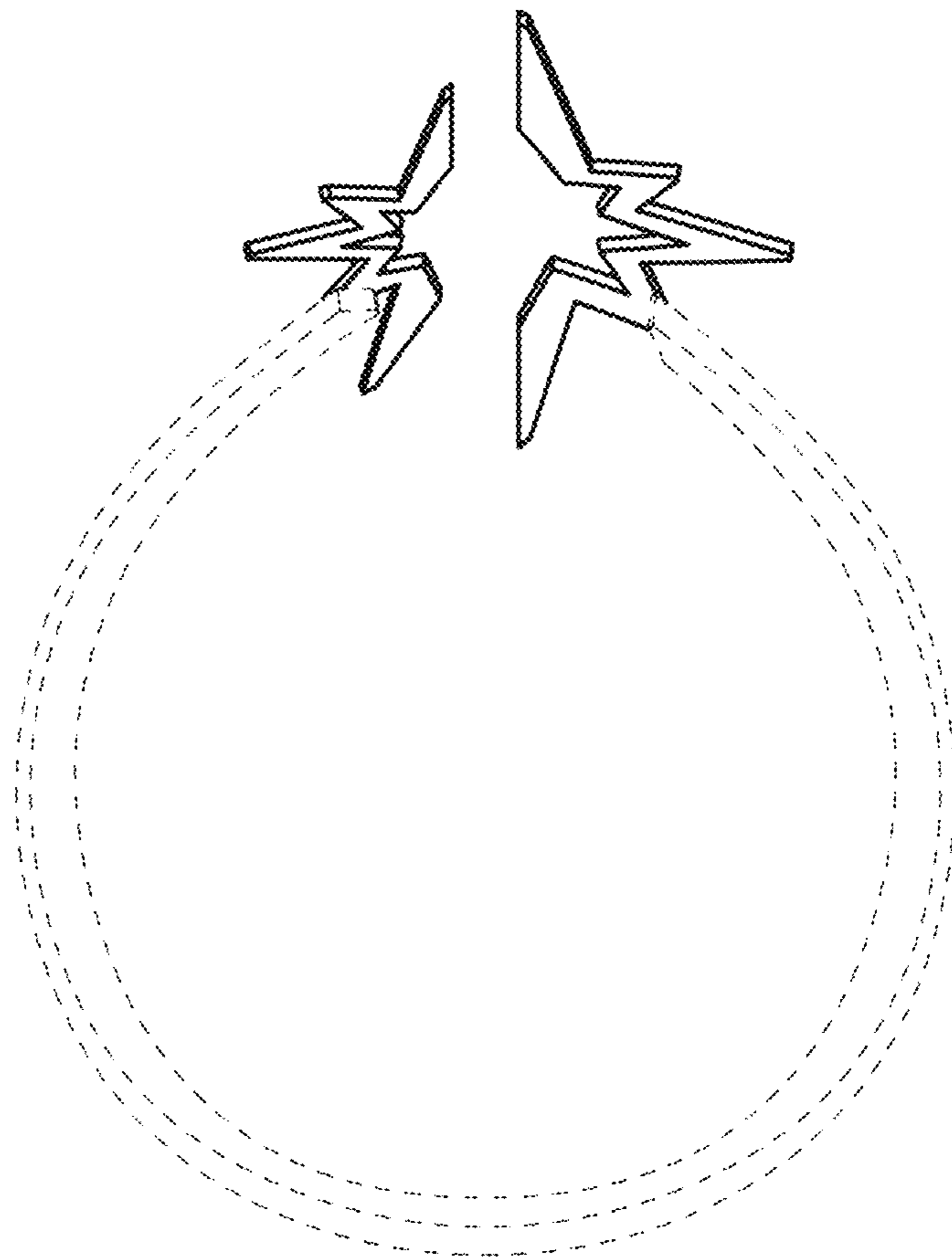

3.1
Perspective

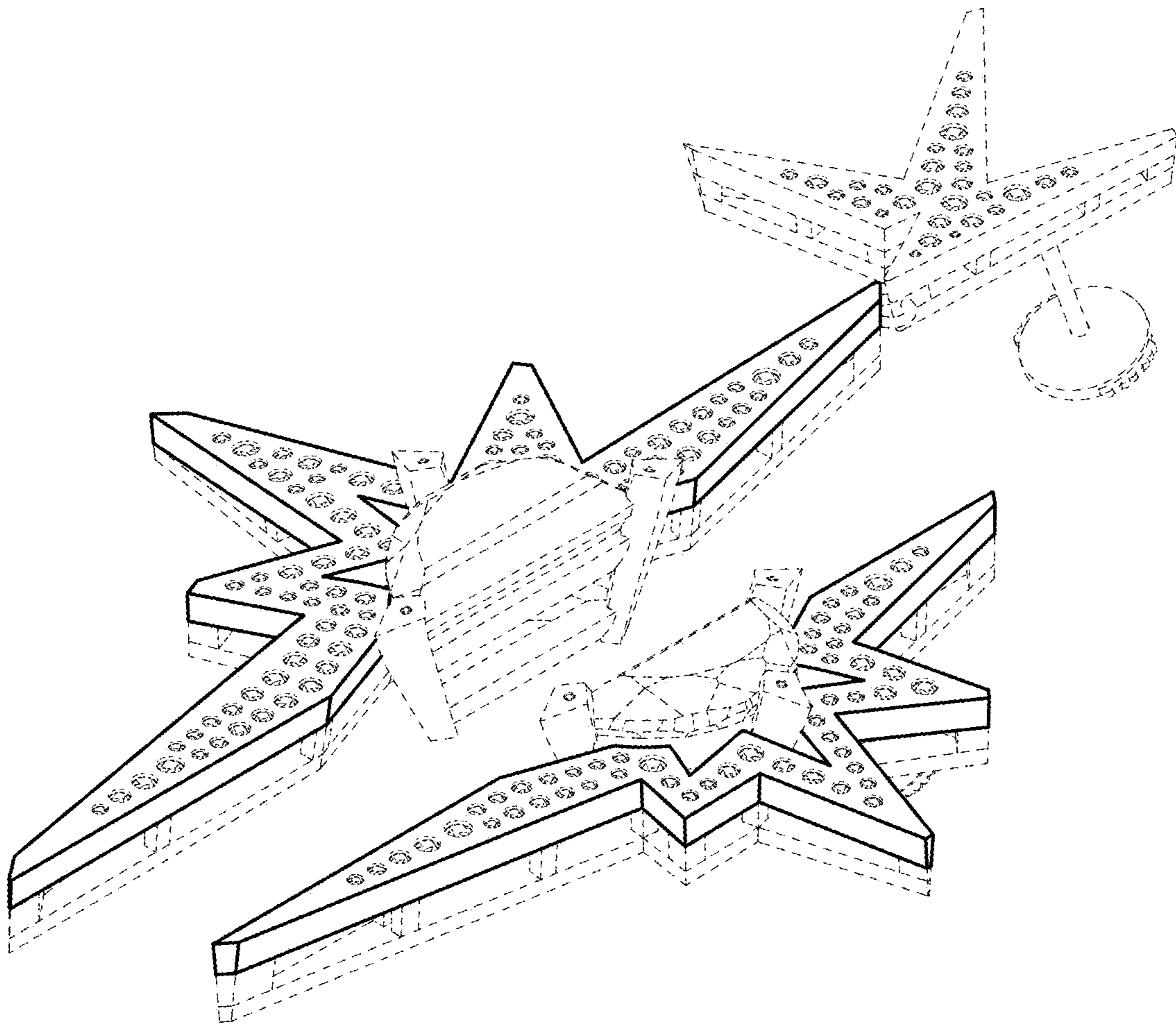

3.2
Perspective

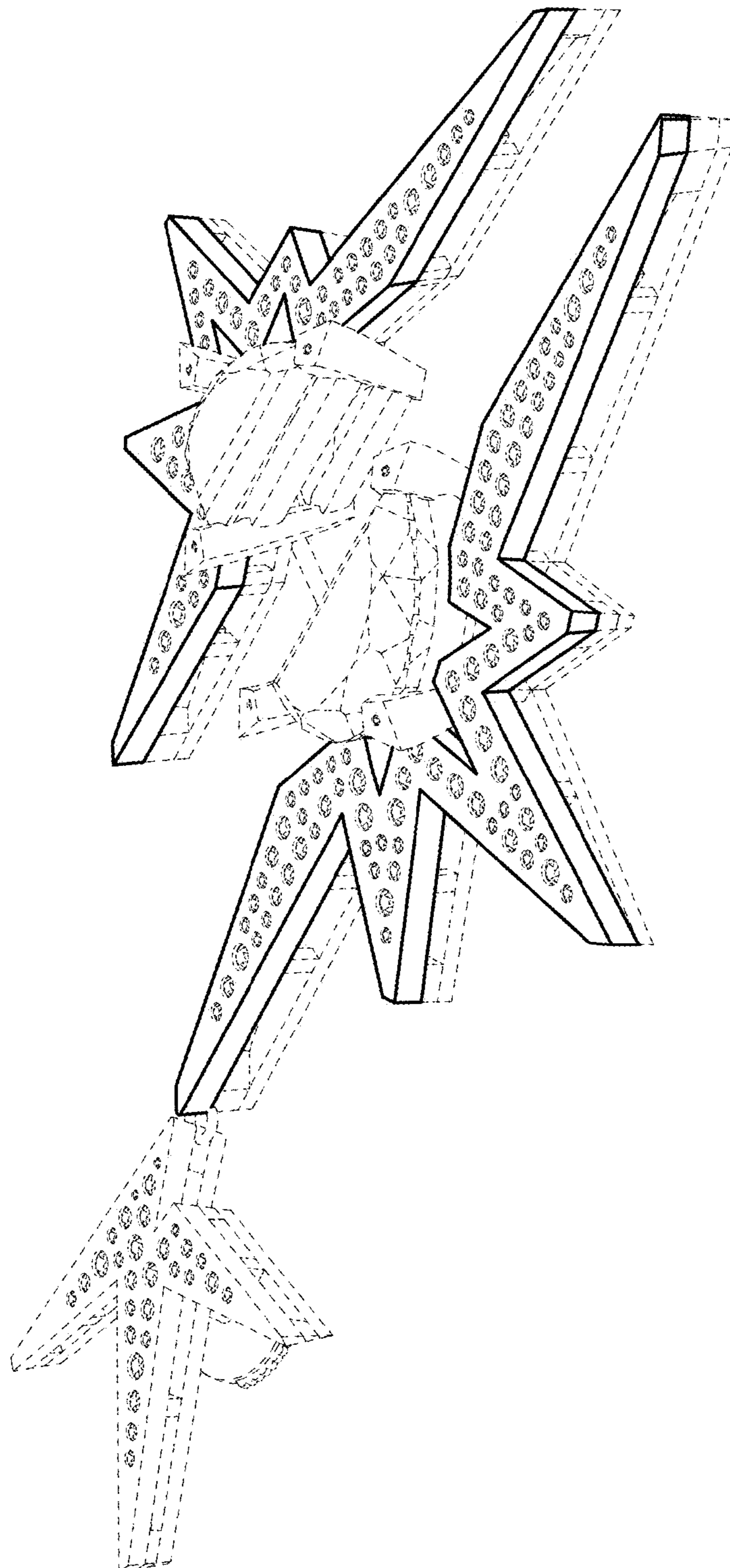

3.3
Front

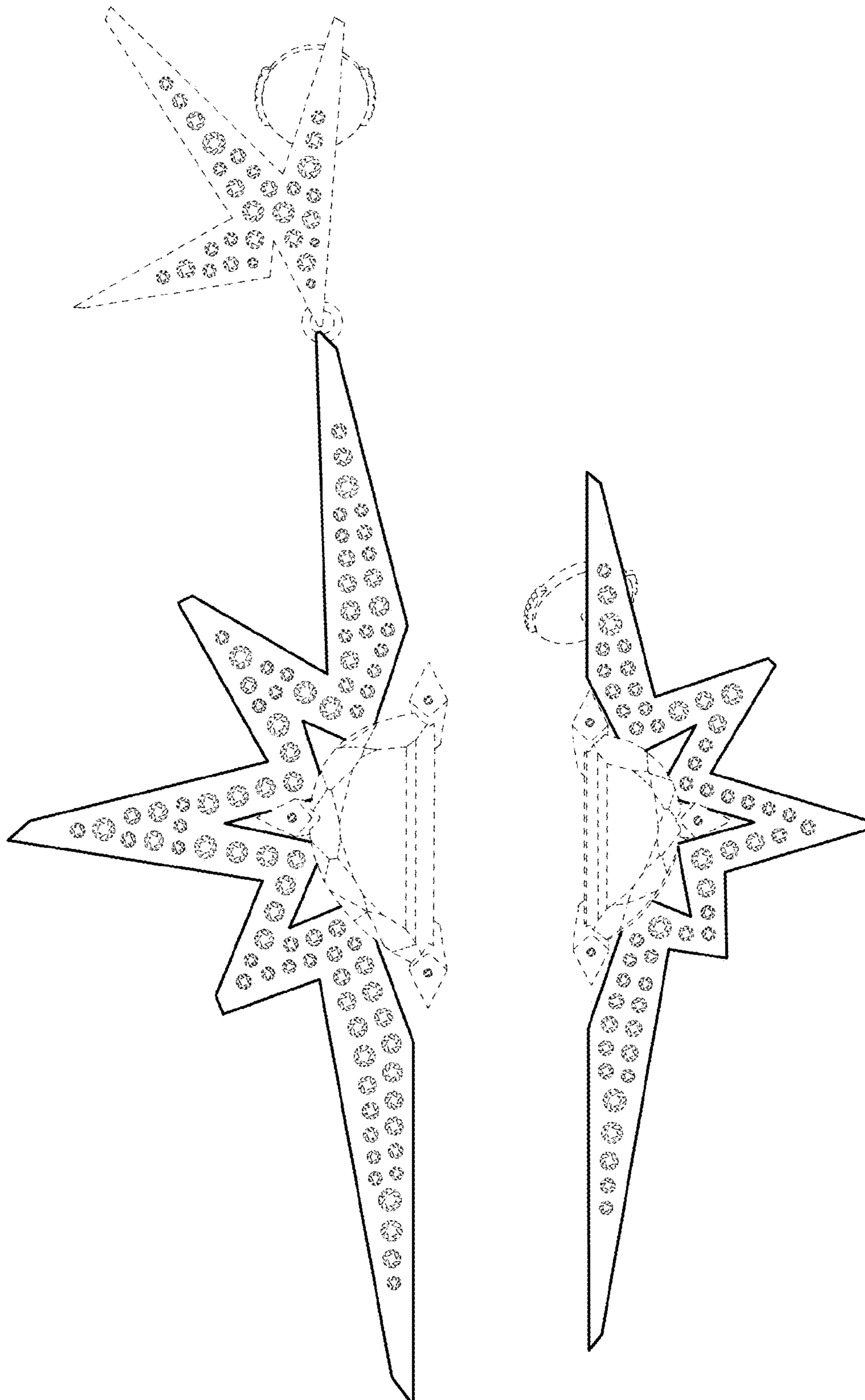

3.4
Back

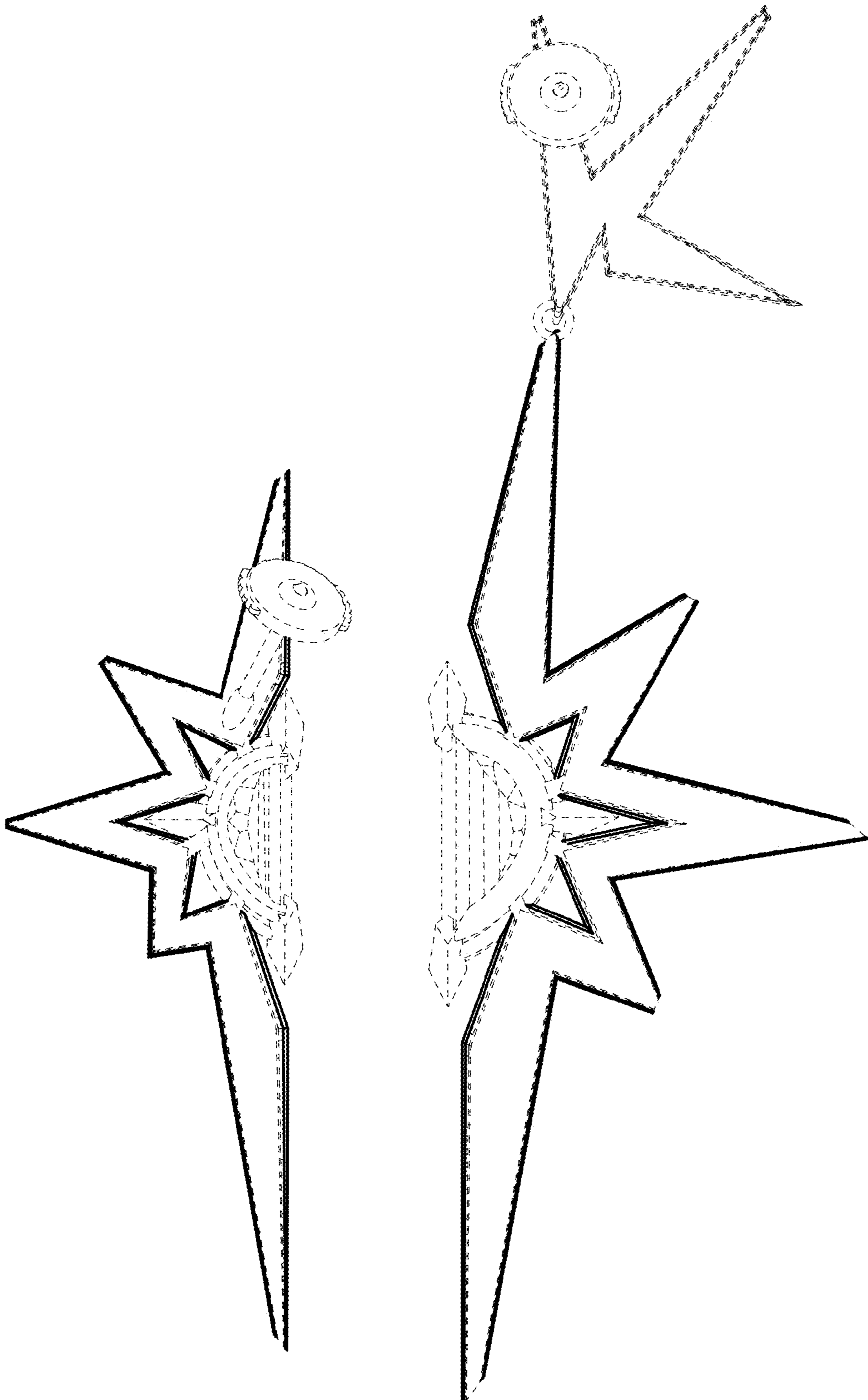

3.5
Right

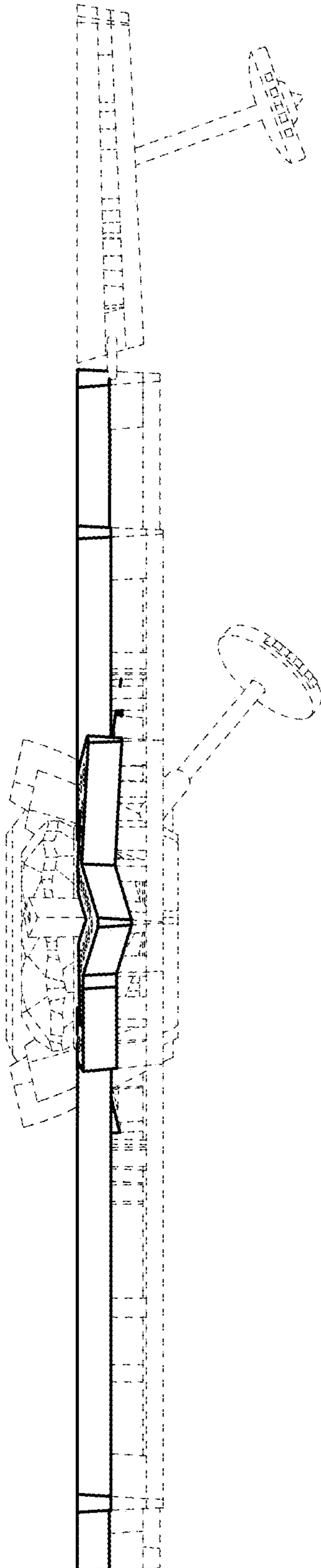

3.6
Left

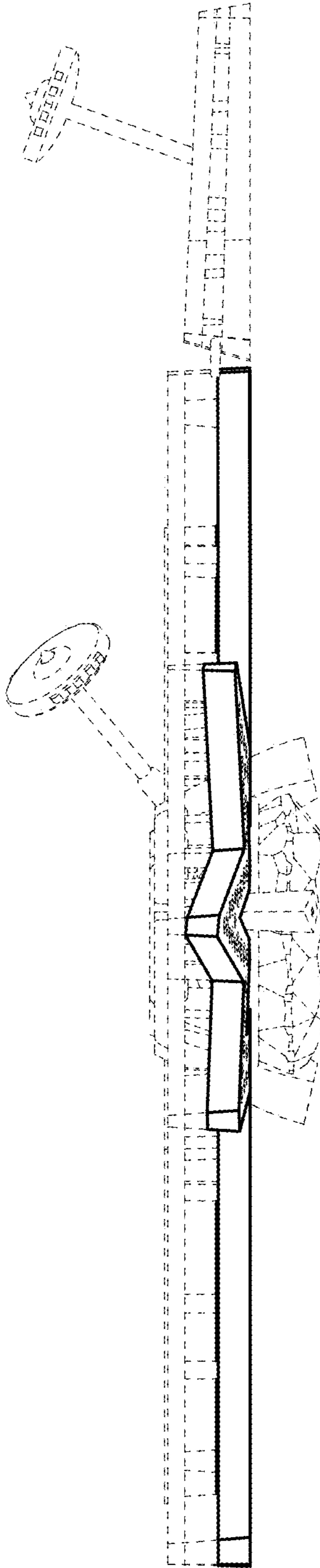

3.7
Top

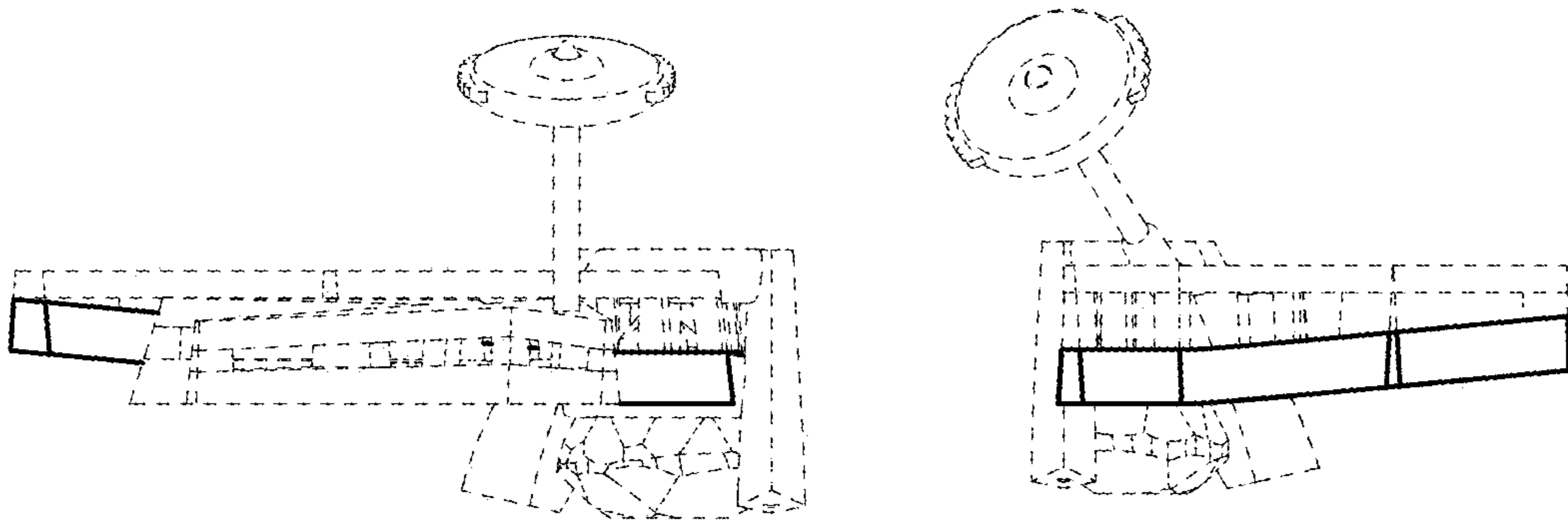

3.8
Bottom

