



US00D895419S

(12) **United States Design Patent**
Huang et al.

(10) **Patent No.:** **US D895,419 S**

(45) **Date of Patent:** **** Sep. 8, 2020**

(54) **CONTAINER**

(71) Applicant: **The Procter & Gamble Company,**
Cincinnati, OH (US)

(72) Inventors: **Sun-Jan Alan Huang,** Cincinnati, OH
(US); **Mark Robert Sivik,** Mason, OH
(US); **Frank William Denome,**
Hamilton, OH (US); **Christopher Lee**
Haun, Amelia, OH (US)

(73) Assignee: **The Procter & Gamble Company,**
Cincinnati, OH (US)

(**) Term: **15 Years**

(21) Appl. No.: **29/717,045**

(22) Filed: **Dec. 13, 2019**

Related U.S. Application Data

(62) Division of application No. 29/628,782, filed on Dec.
7, 2017, now Pat. No. Des. 873,129.

(51) **LOC (12) Cl.** **09-03**

(52) **U.S. Cl.**
USPC **D9/420**

(58) **Field of Classification Search**

USPC D9/414-419, 423, 426, 430, 432, 721,
D9/730, 734, 737; D3/290, 294, 304,
D3/305, 315; D7/600.1, 601
CPC ... B65D 5/00; B65D 5/02; B65D 5/18; B65D
5/20; B65D 5/66; B65D 5/325; B65D
5/6644; B65D 5/6647; B65D 83/00;
B65D 83/08; B65D 83/005; B65D
83/0083; B65D 83/0841; B65D 83/0882;
B65D 43/16; B65D 43/162; B26D 1/045

See application file for complete search history.

(56) **References Cited**

U.S. PATENT DOCUMENTS

1,599,238 A * 9/1926 Hurlbut B65D 83/0882
225/50

D108,605 S * 2/1938 Nagle D9/433

2,507,404 A * 5/1950 Gluck B65D 83/0882
225/20

2,522,253 A * 9/1950 Broeren B65D 83/0882
225/43

D195,430 S * 6/1963 Maps D9/600

D269,934 S * 8/1983 Hawkins D7/590

D271,000 S * 10/1983 Rimer D9/420

(Continued)

Primary Examiner — Wan Laymon

Assistant Examiner — Clint A Samuel

(74) *Attorney, Agent, or Firm* — Gary J. Foose

(57) **CLAIM**

The ornamental design for a container, as shown and
described.

DESCRIPTION

FIG. 1 is a top perspective view of a container embodying
our new design;

FIG. 2 is a front view of the container of FIG. 1;

FIG. 3 is a left view of the container of FIG. 1;

FIG. 4 is a back view of the container of FIG. 1;

FIG. 5 is a right view of the container of FIG. 1;

FIG. 6 is a top view of the container of FIG. 1;

FIG. 7 is a bottom view of the container of FIG. 1;

FIG. 8 is a top perspective view the container of FIG. 1
wherein the top panel of the container is in a closed position;

FIG. 9 is a front view of the container of FIG. 8;

FIG. 10 is a left view of the container of FIG. 8;

FIG. 11 is a back view of the container of FIG. 8;

FIG. 12 is a right view of the container of FIG. 8;

FIG. 13 is a top view of the container of FIG. 8; and,

FIG. 14 is a bottom view of the container of FIG. 8.

The broken line showing in the drawings is included for the
purpose of illustrating unclaimed portions of the container
and forms no part of the claimed design.

1 Claim, 6 Drawing Sheets

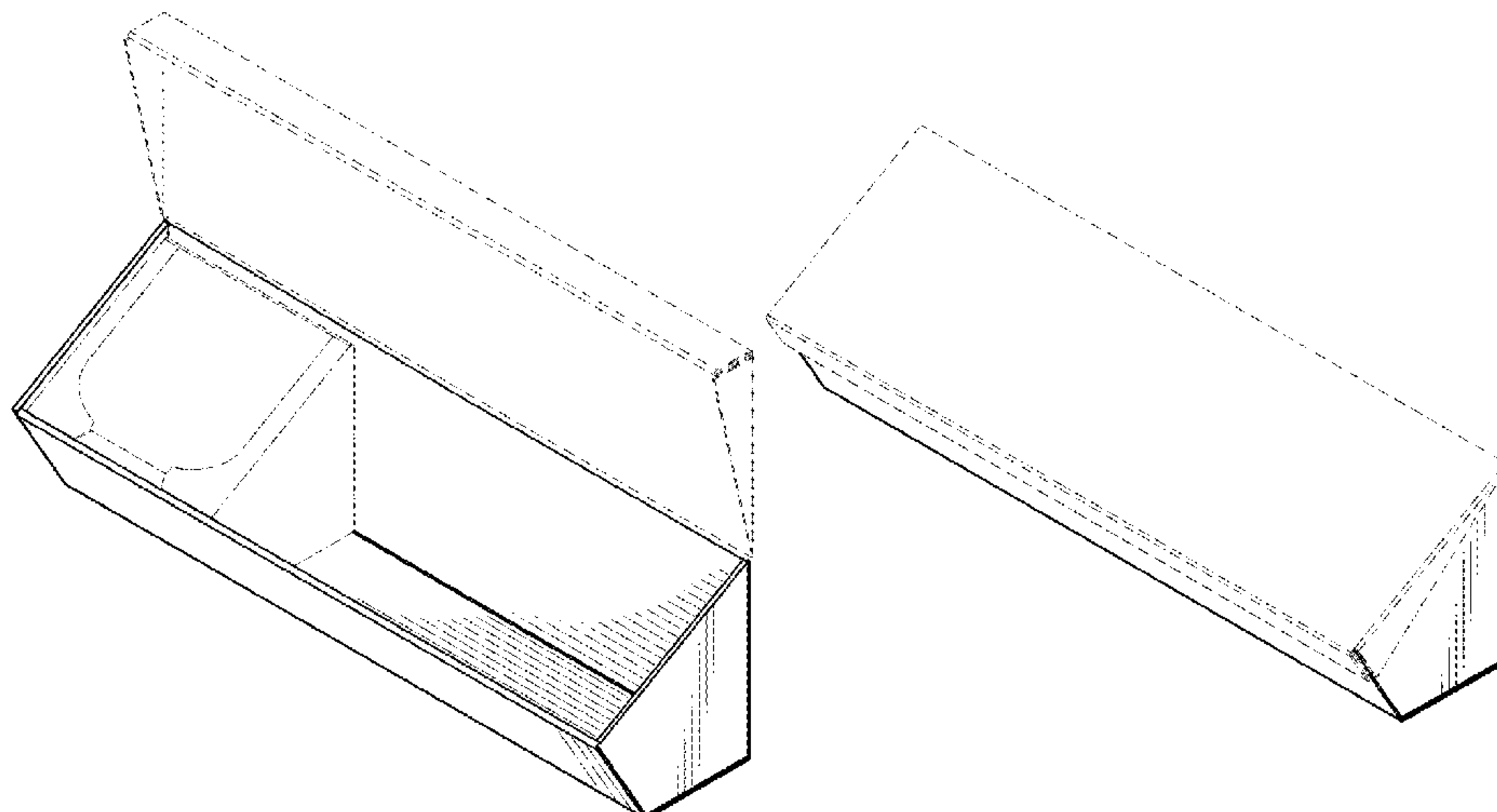

(56)

References Cited

U.S. PATENT DOCUMENTS

4,651,911 A * 3/1987 Kirkup B65D 83/0841
 225/20
 4,787,542 A * 11/1988 Ruff B65H 35/002
 225/1
 D341,499 S * 11/1993 Horne D12/425
 D402,512 S * 12/1998 Lee D7/600.1
 D421,691 S * 3/2000 Hoblitz D6/522
 D572,904 S * 7/2008 Beckerman D3/304
 8,528,801 B2 * 9/2013 Tanaka B65D 83/0841
 225/39
 D745,392 S * 12/2015 Solovov, Jr. D9/433
 9,221,646 B1 * 12/2015 Amara B65H 35/002
 D815,522 S * 4/2018 Vegliante D9/432
 10,017,616 B2 * 7/2018 Ueda B65D 65/02
 D830,722 S * 10/2018 Klipshtein D6/518
 D842,095 S * 3/2019 Hajek D9/431
 D861,477 S * 10/2019 Smith D9/420
 10,507,949 B1 * 12/2019 Nunez B65D 85/32
 D873,129 S * 1/2020 Huang D9/420
 D874,567 S * 2/2020 Wang D19/108
 2003/0164392 A1 * 9/2003 Gerulski B26F 3/02
 225/1

2004/0089691 A1 * 5/2004 Gerulski B26F 3/02
 225/93
 2005/0035133 A1 * 2/2005 Gerulski B65H 35/0086
 221/31
 2005/0166738 A1 * 8/2005 Hsu B65D 83/0882
 83/614
 2007/0074986 A1 * 4/2007 King B65D 83/0841
 206/397
 2010/0320250 A1 * 12/2010 Hideoka B26F 3/02
 225/91
 2011/0209594 A1 * 9/2011 Withers B65H 35/0086
 83/614
 2014/0263527 A1 * 9/2014 Mukohara B65D 83/0841
 225/43
 2015/0060318 A1 * 3/2015 Lee B35D 5/5004
 206/389
 2016/0355647 A1 * 12/2016 Ueda B65D 65/02
 2018/0037362 A9 * 2/2018 Matsumura B65D 5/66
 2018/0141742 A1 * 5/2018 Vegliante B65D 83/0841
 2018/0141743 A1 * 5/2018 Vegliante B65H 35/0086
 2018/0305164 A1 * 10/2018 Smith B26D 1/045
 2018/0370679 A1 * 12/2018 Shimizu B65D 5/22
 2019/0315566 A1 * 10/2019 Kishi C09J 7/245
 2019/0375550 A1 * 12/2019 Yen B65D 25/04

* cited by examiner

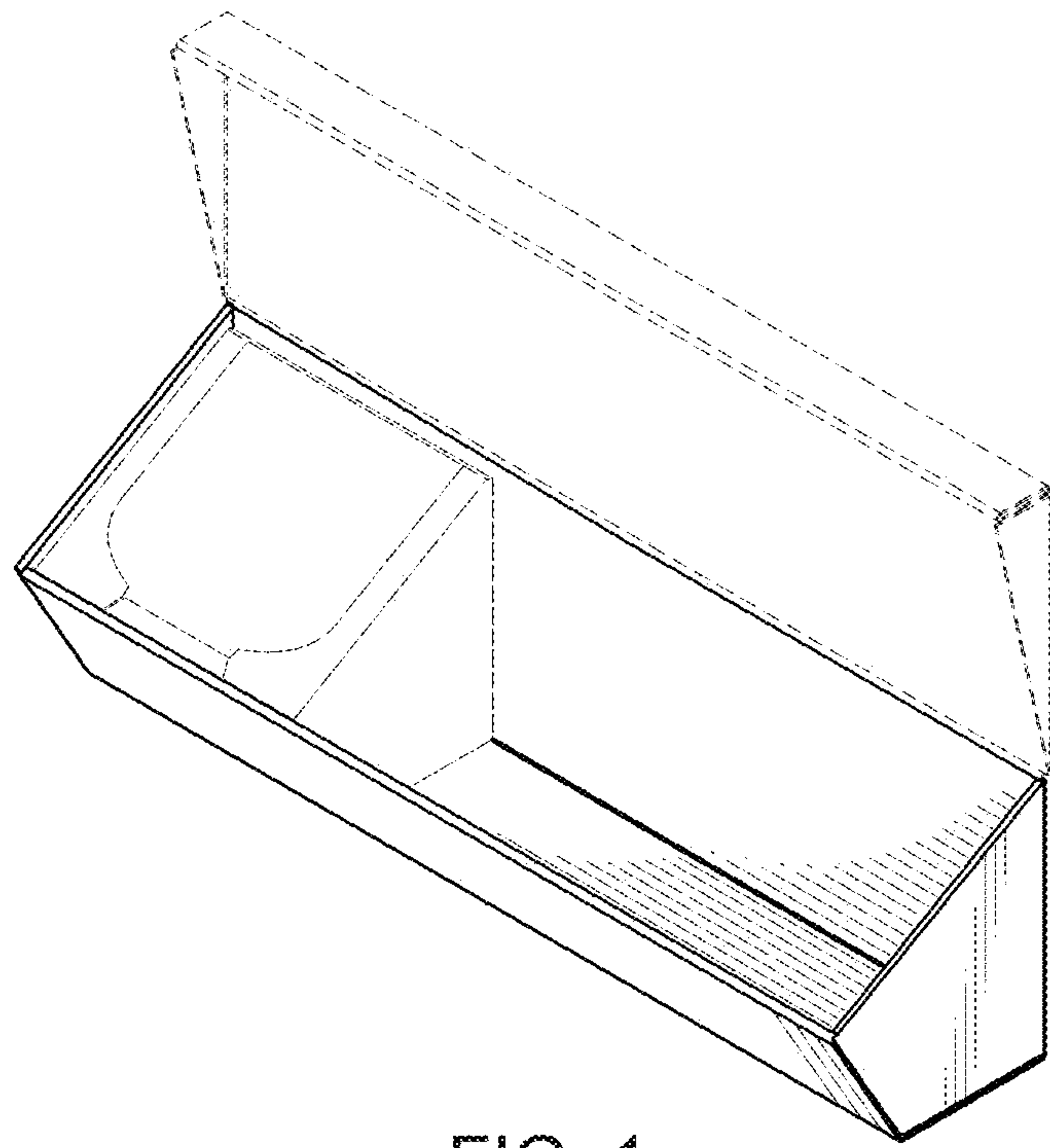

FIG. 1

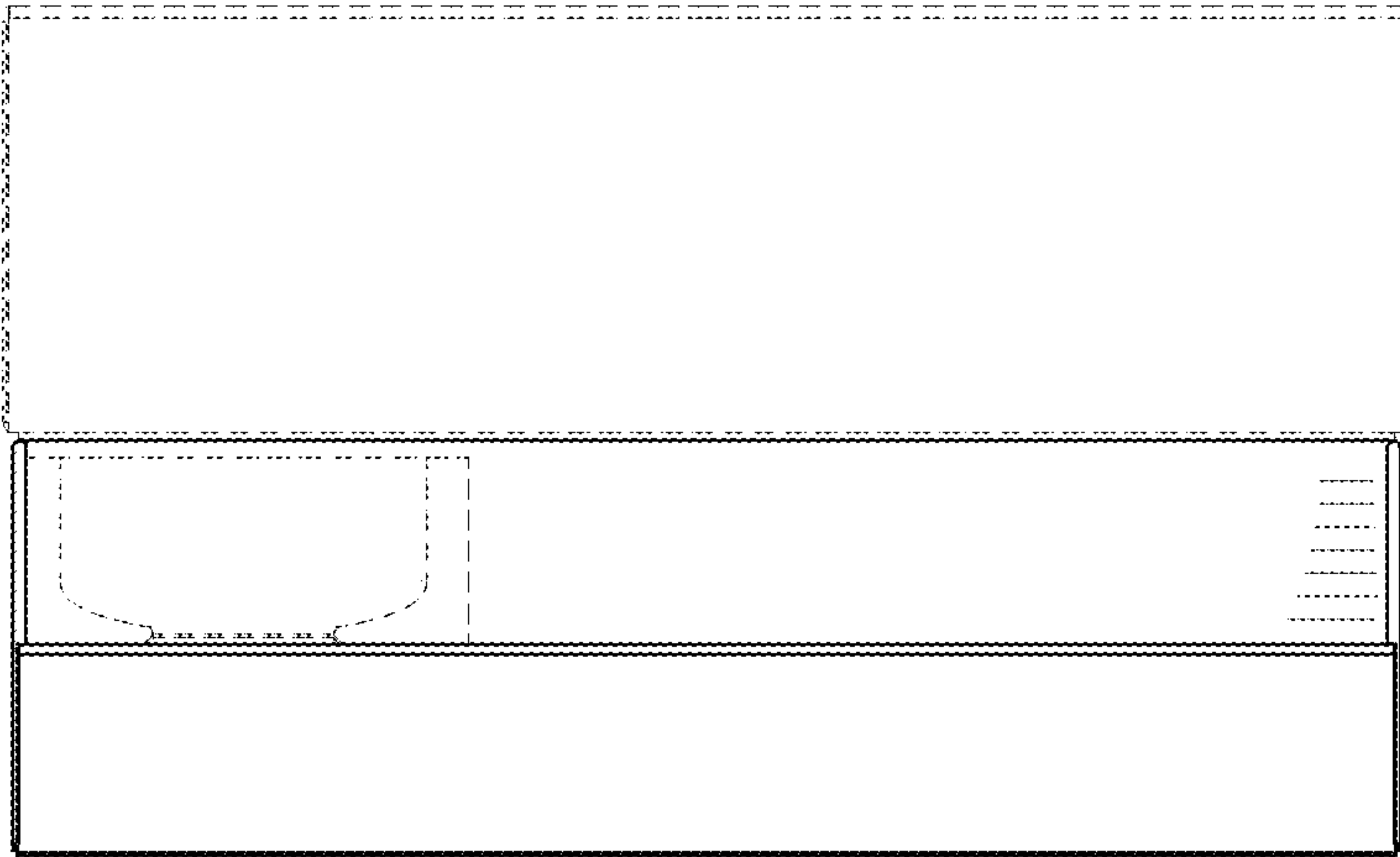

FIG. 2

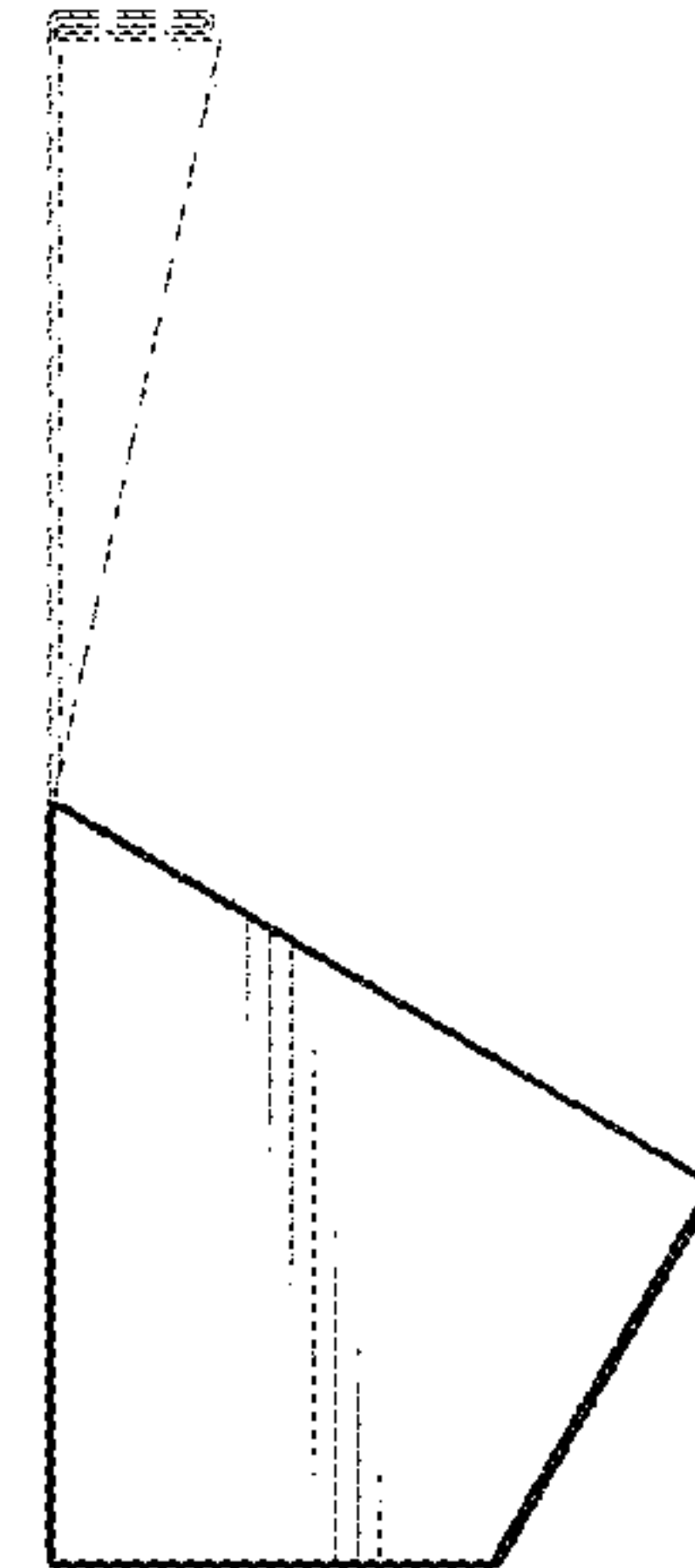

FIG. 3

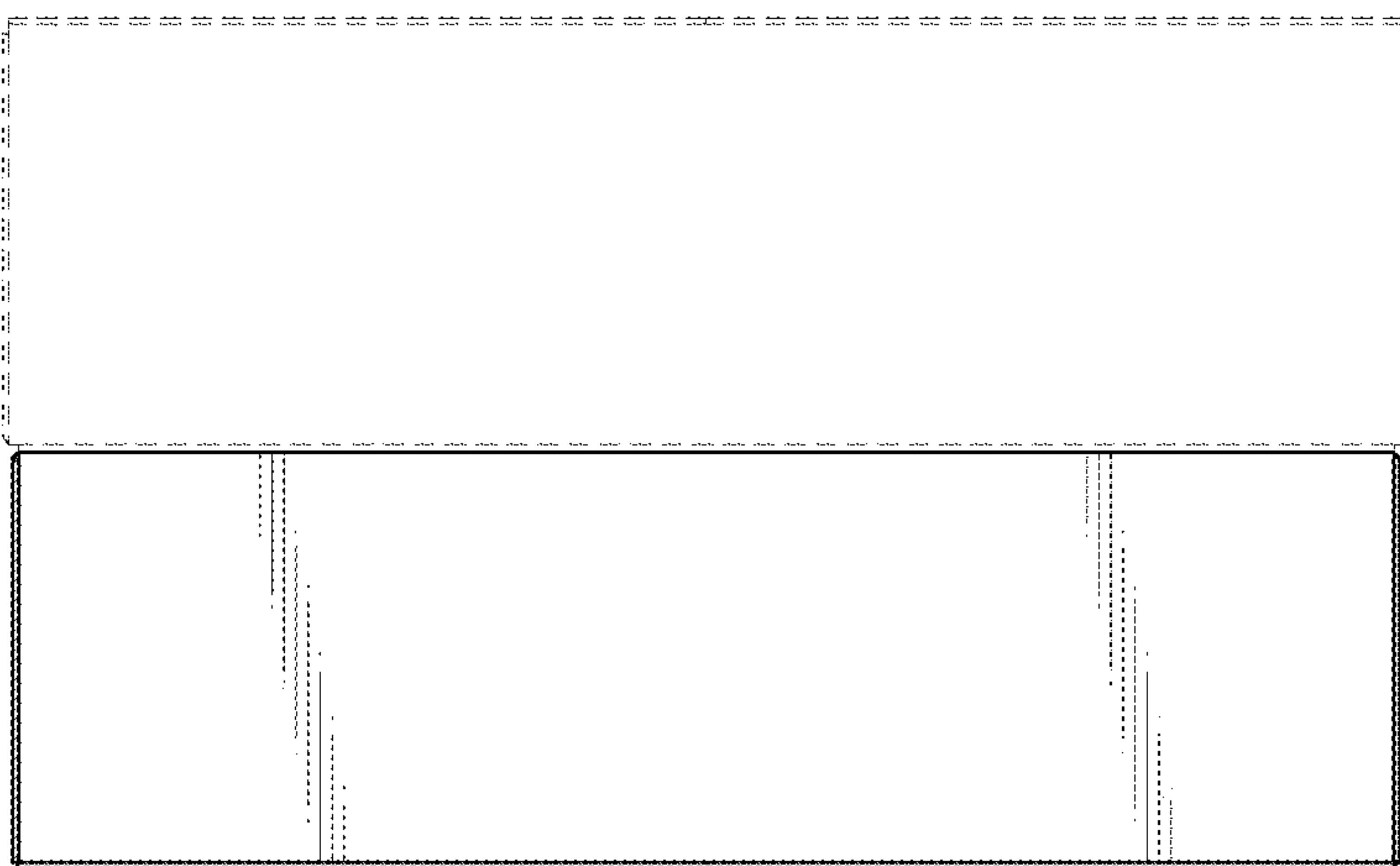

FIG. 4

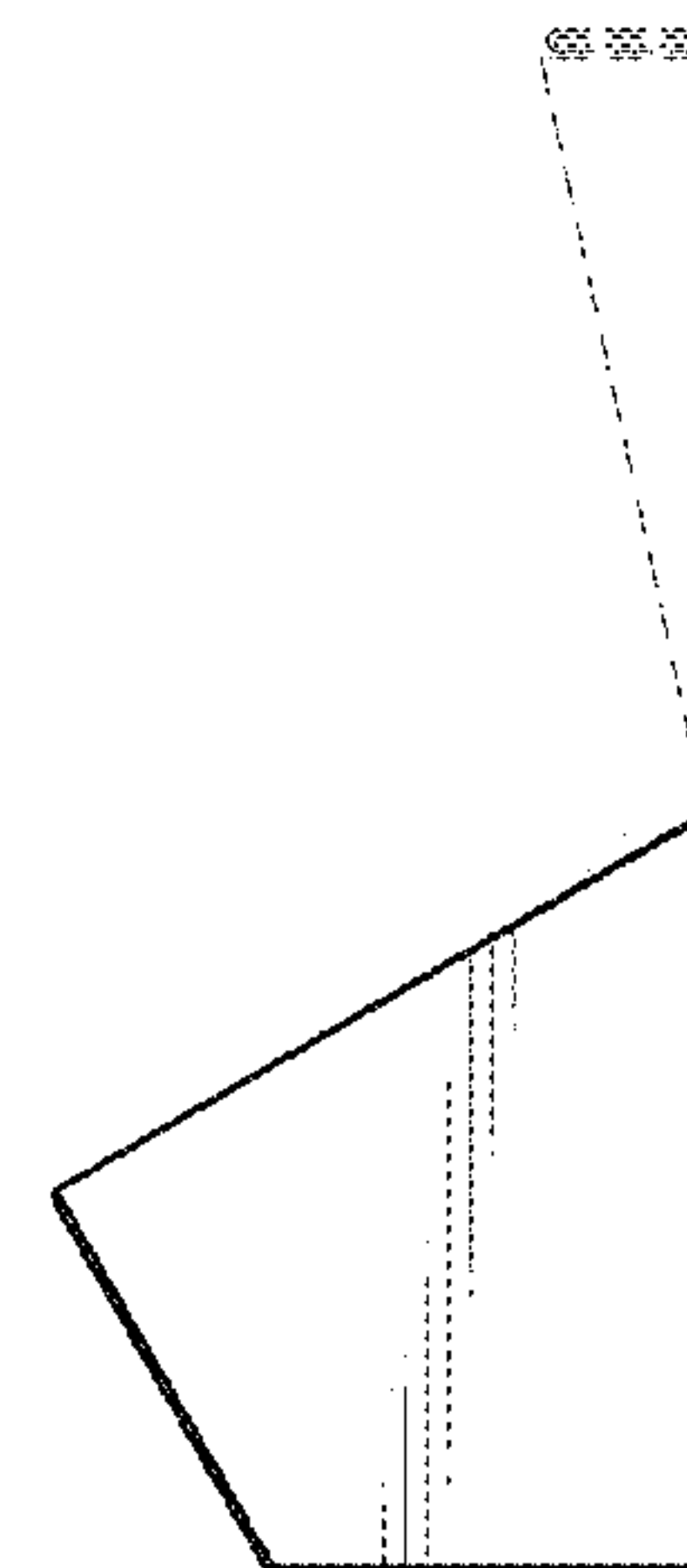

FIG. 5

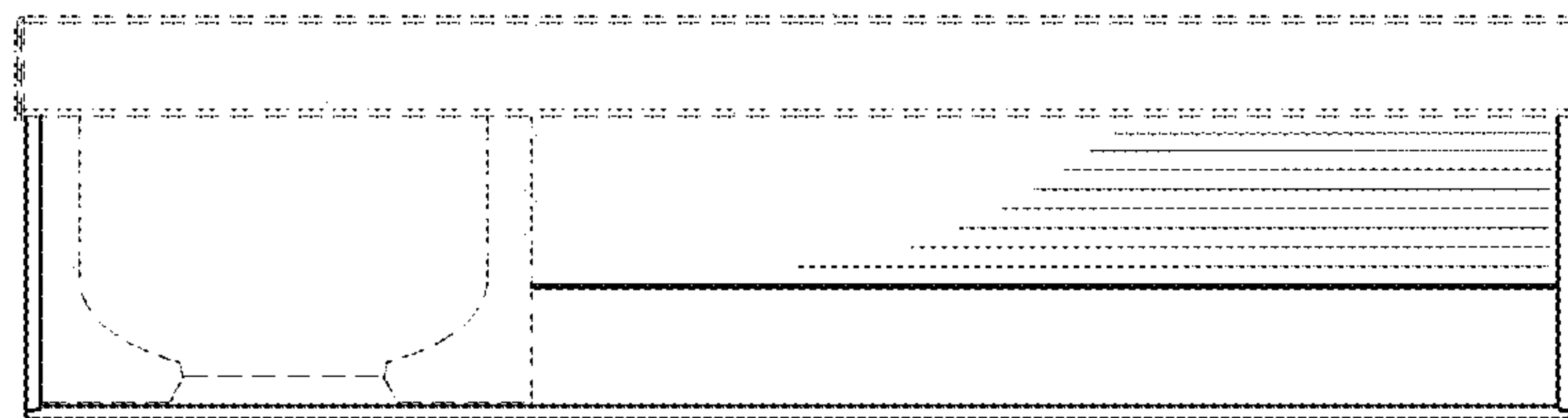

FIG. 6

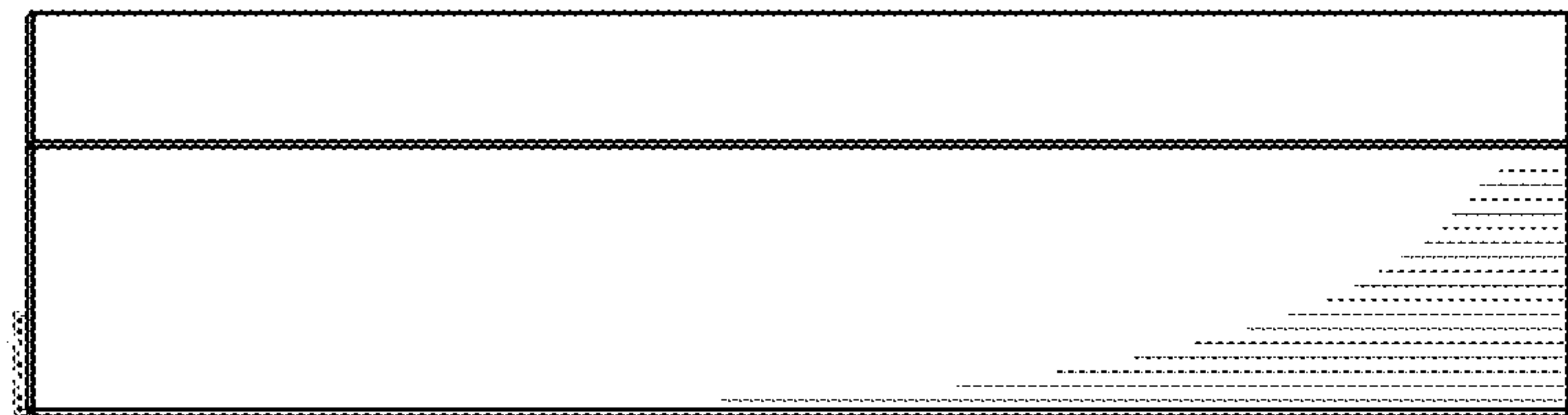

FIG. 7

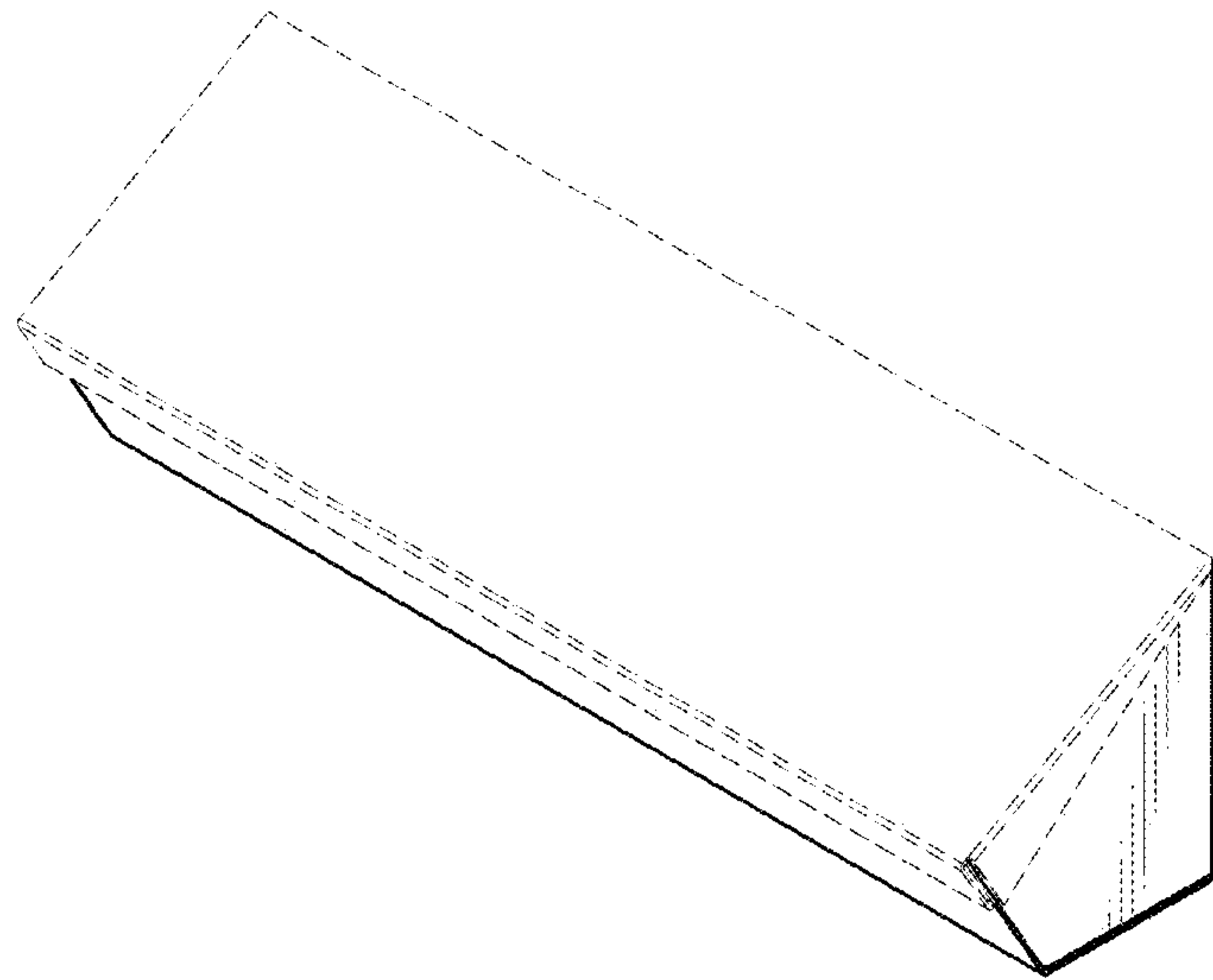

FIG. 8

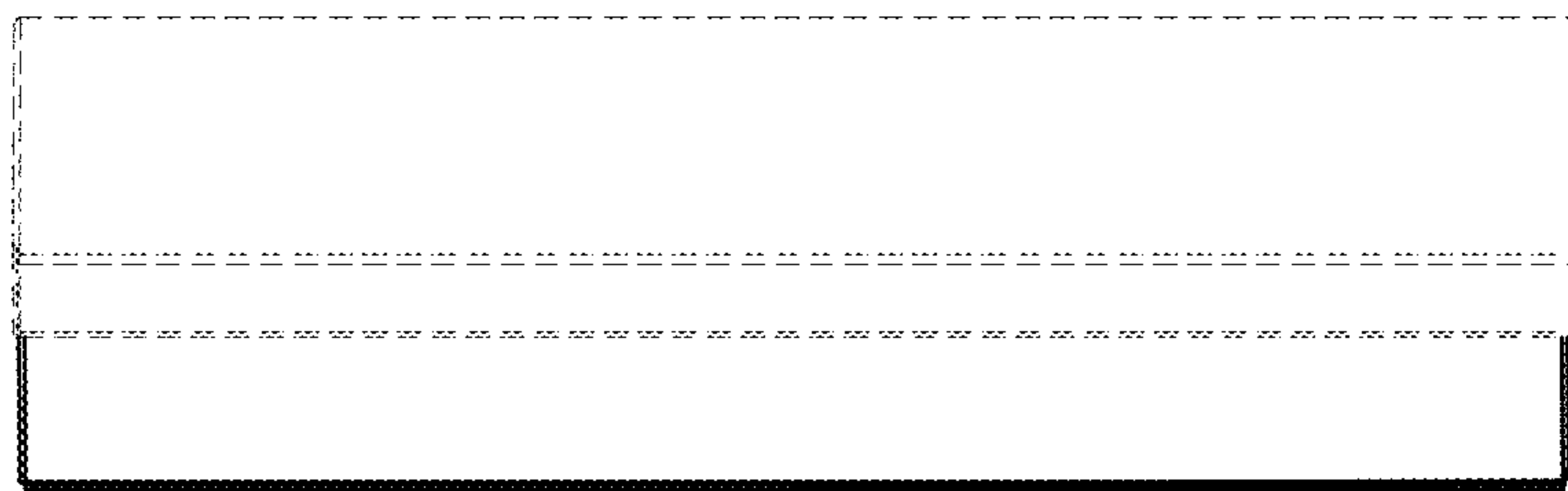

FIG. 9

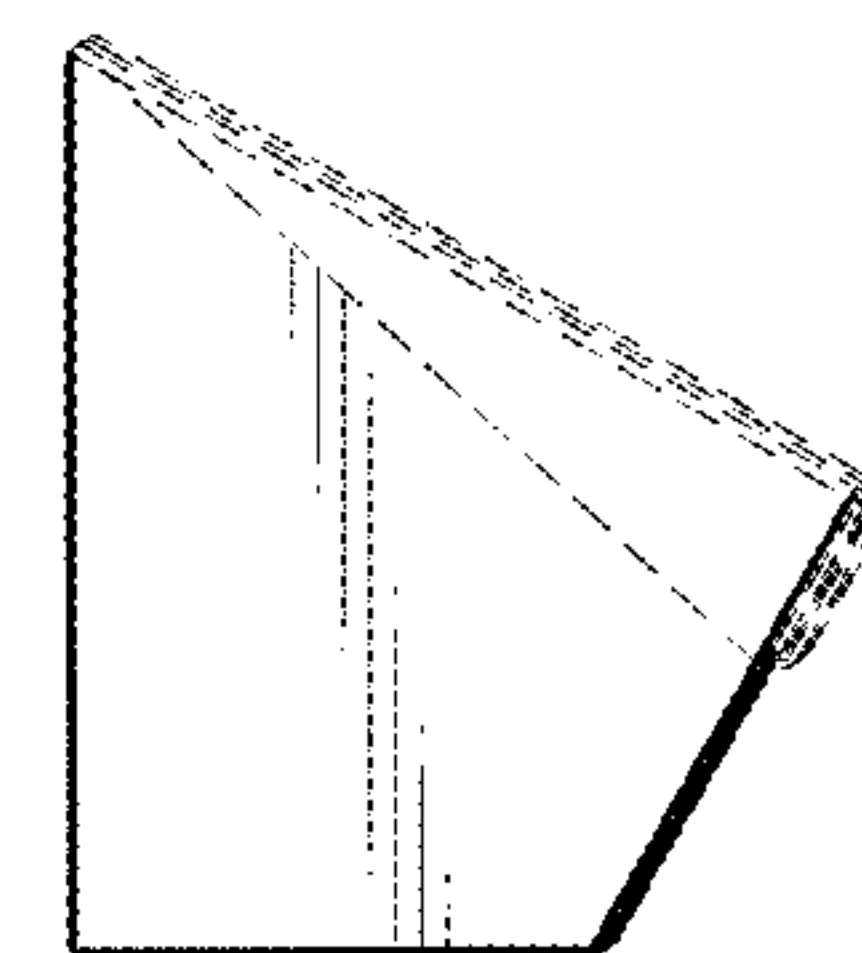

FIG. 10

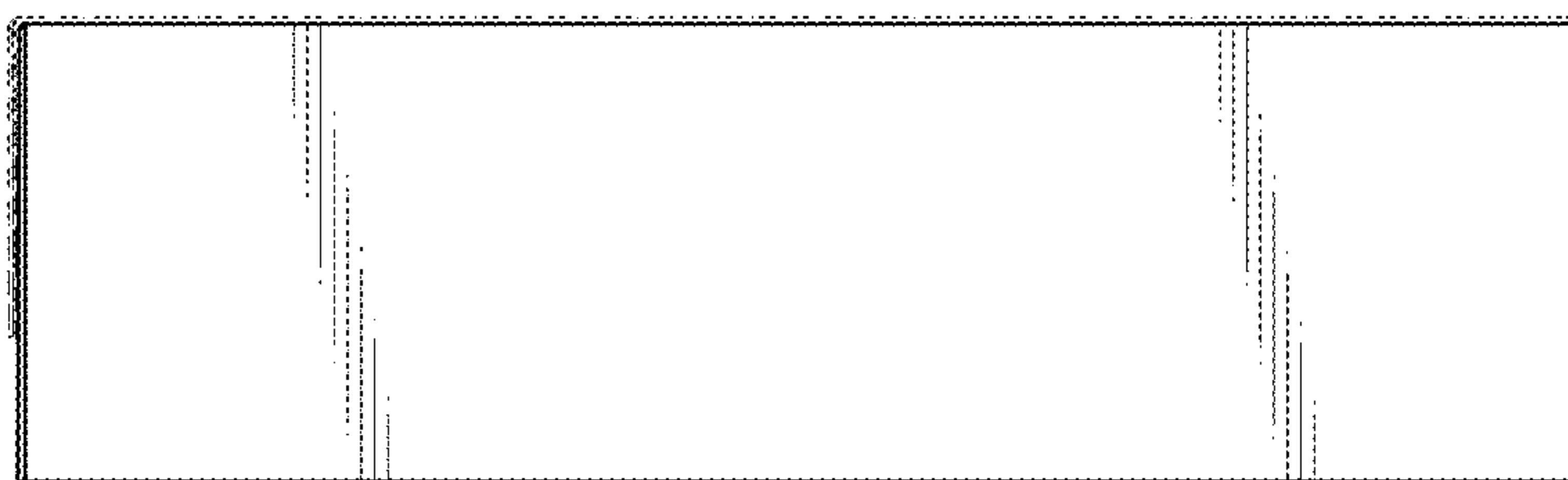

FIG. 11

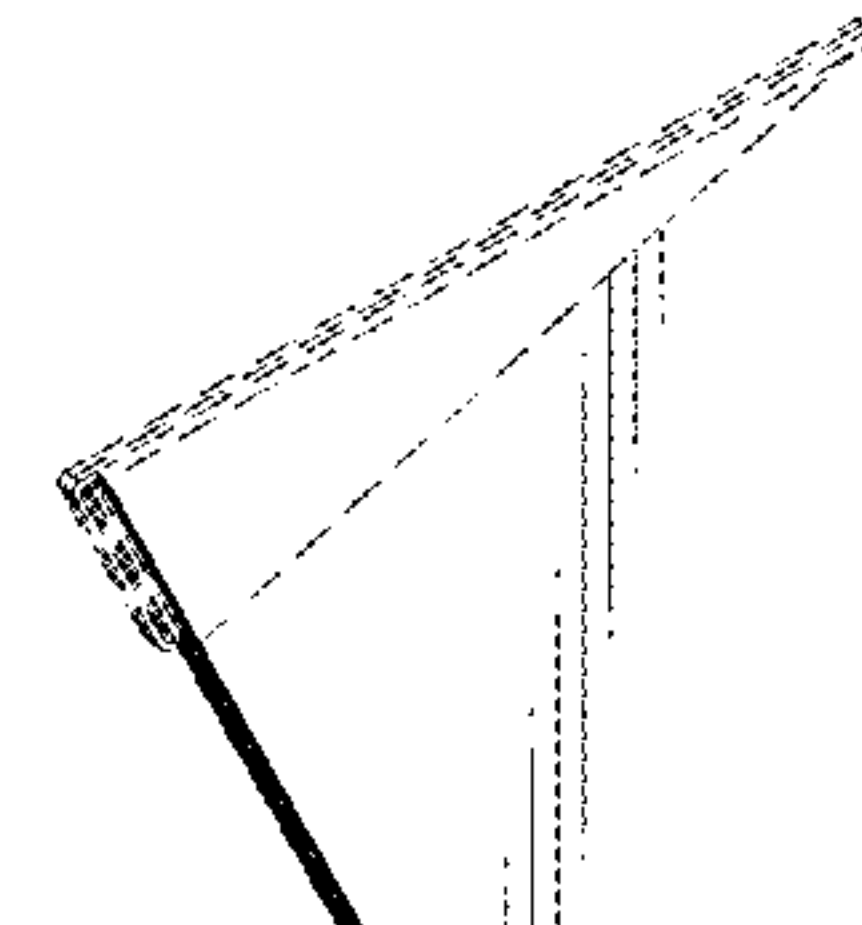

FIG. 12

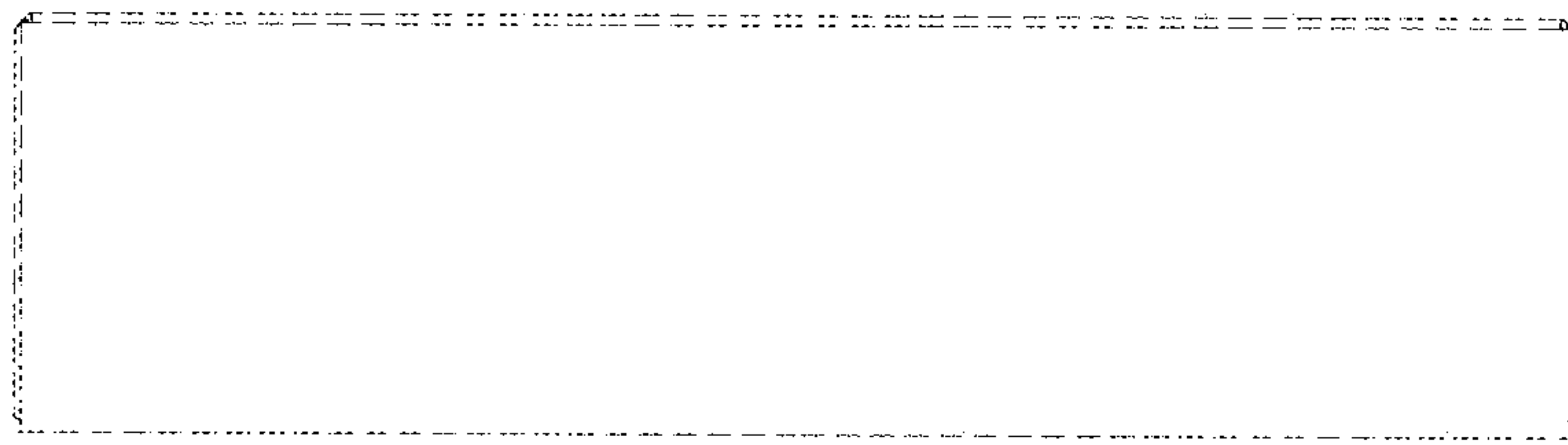

FIG. 13

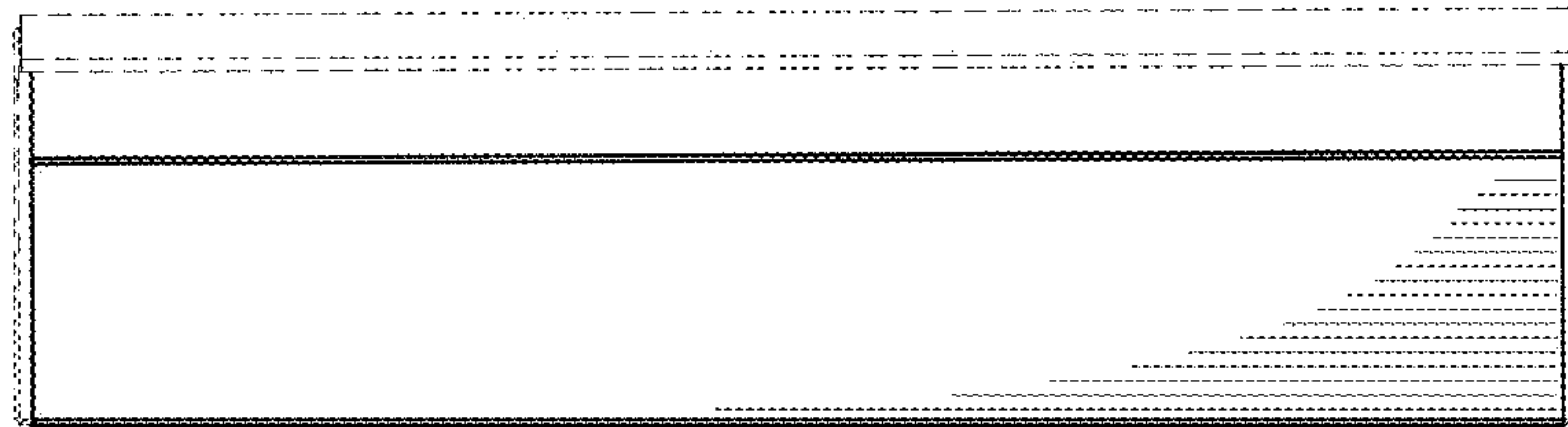

FIG. 14