



US00D895367S

(12) **United States Design Patent**
Hamilton

(10) **Patent No.:** **US D895,367 S**

(45) **Date of Patent:** **** Sep. 8, 2020**

(54) **BEVERAGE CONTAINER**

(71) Applicant: **MAGNOLIA INTELLECTUAL
DESIGNS LLC**, Dallas, TX (US)

(72) Inventor: **Mary Nicole Hamilton**, Heath, TX
(US)

(73) Assignee: **MAGNOLIA INTELLECTUAL
DESIGNS, LLC**, Dallas, TX (US)

(**) Term: **15 Years**

(21) Appl. No.: **29/690,573**

(22) Filed: **May 9, 2019**

(51) **LOC (12) Cl.** **07-01**

(52) **U.S. Cl.**
USPC **D7/523; D7/509**

(58) **Field of Classification Search**
USPC D7/507, 509, 510, 511, 529, 531, 532,
D7/523, 533, 534, 535, 536, 392.1, 296.1,
D7/396.2, 300.1, 608; D3/202
CPC A47G 19/22; A47G 19/2288; A47G
19/2205; A47J 41/0077; A47J 41/0088
See application file for complete search history.

(56) **References Cited**

U.S. PATENT DOCUMENTS

4,974,741 A * 12/1990 Gustafson B65D 81/3886
206/486
5,531,353 A * 7/1996 Ward A47G 19/2227
220/23.86
D379,738 S * 6/1997 Liming D7/510

D417,365 S * 12/1999 Huang D7/511
D513,916 S * 1/2006 Namee D7/300.1
7,194,951 B1 * 3/2007 Porter A47J 31/005
100/116
D713,686 S * 9/2014 Eyal D7/509
D808,722 S * 1/2018 Hill D7/510
D872,537 S * 1/2020 Guccione D7/532

OTHER PUBLICATIONS

https://www.amazon.com/REDUCE-COLDEE-Stainless-Steel-Tumbler/dp/B07L39BCLS/ref=redir_mobile_desktop?ie=UTF8&aaxitk=svrhtlvM6X.5Jh8k9dZKYQ&hsa_cr_id=1837658950301&ref_=sb_s_sparkle Reduce Stainless Steel Tumbler (Year: 2018).*

* cited by examiner

Primary Examiner — Jae Liang

(74) *Attorney, Agent, or Firm* — Smith IP Services, P.C.

(57) **CLAIM**

The ornamental design for a beverage container, as shown and described.

DESCRIPTION

FIG. 1 shows a top perspective view of a beverage container, with threading around the inner rim;
FIG. 2 shows a bottom perspective view of the beverage container.
FIG. 3 shows a front elevational view of the beverage container; all sides being identical;
FIG. 4 shows a top view of the beverage container; and,
FIG. 5 shows a bottom view of the beverage container.

1 Claim, 4 Drawing Sheets

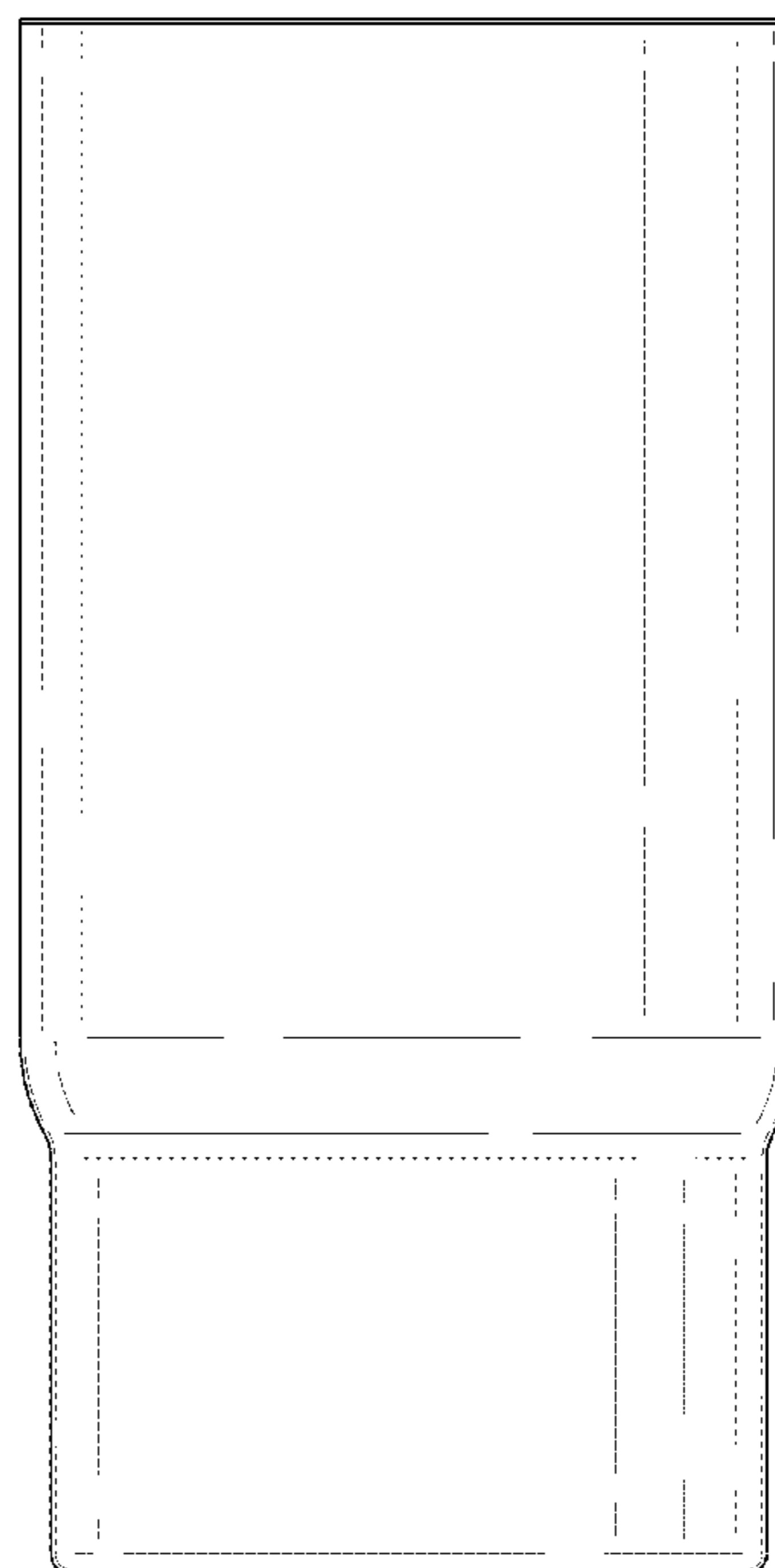
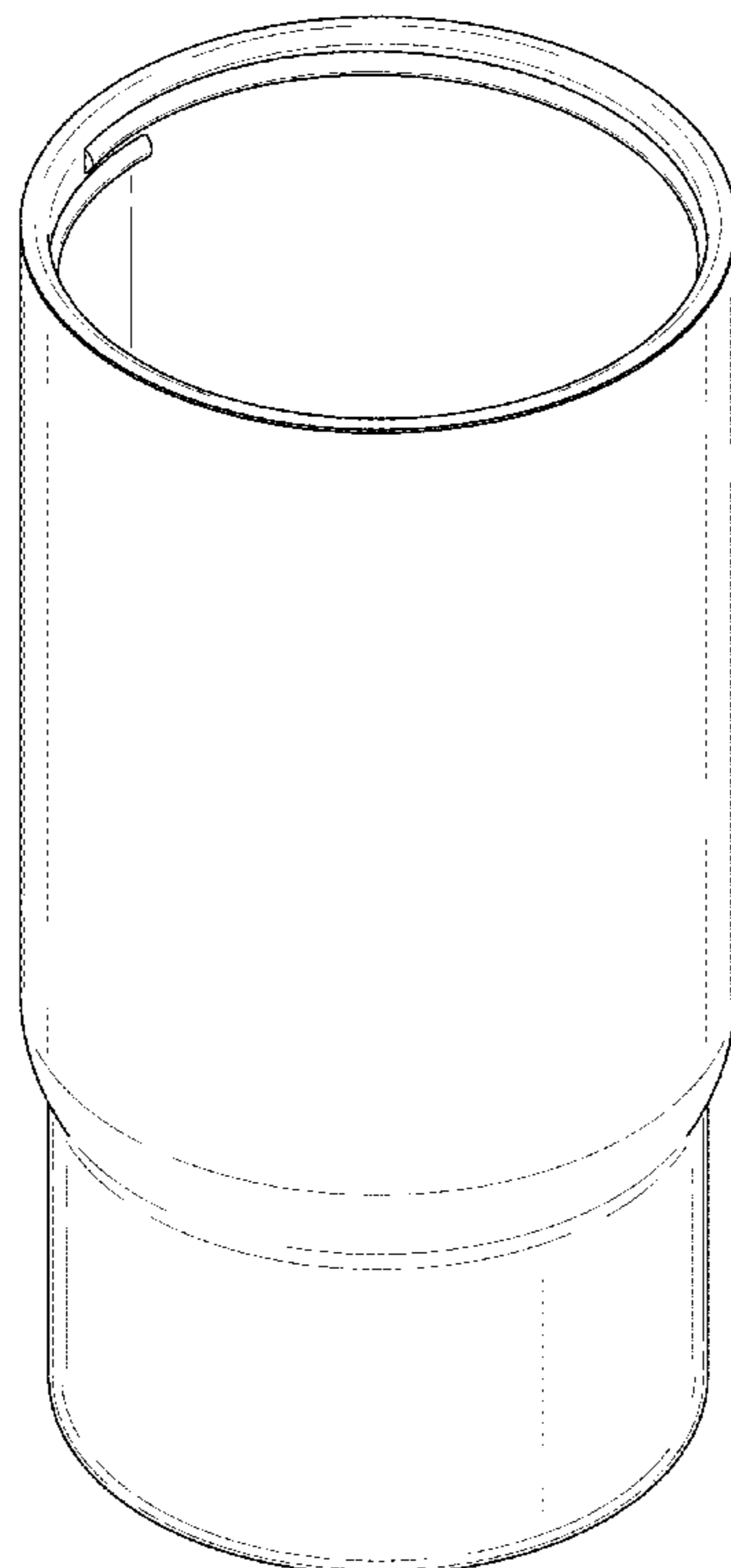

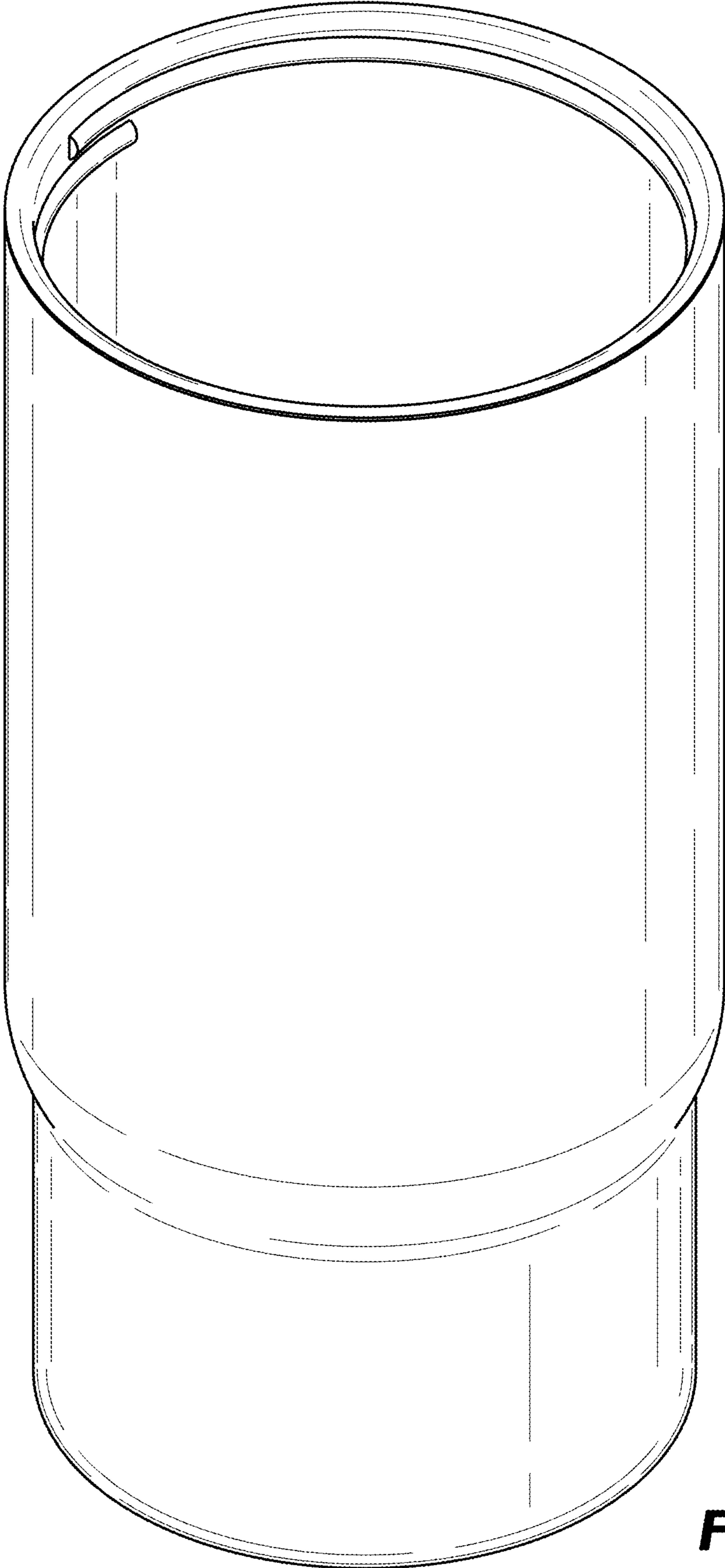

FIG.1

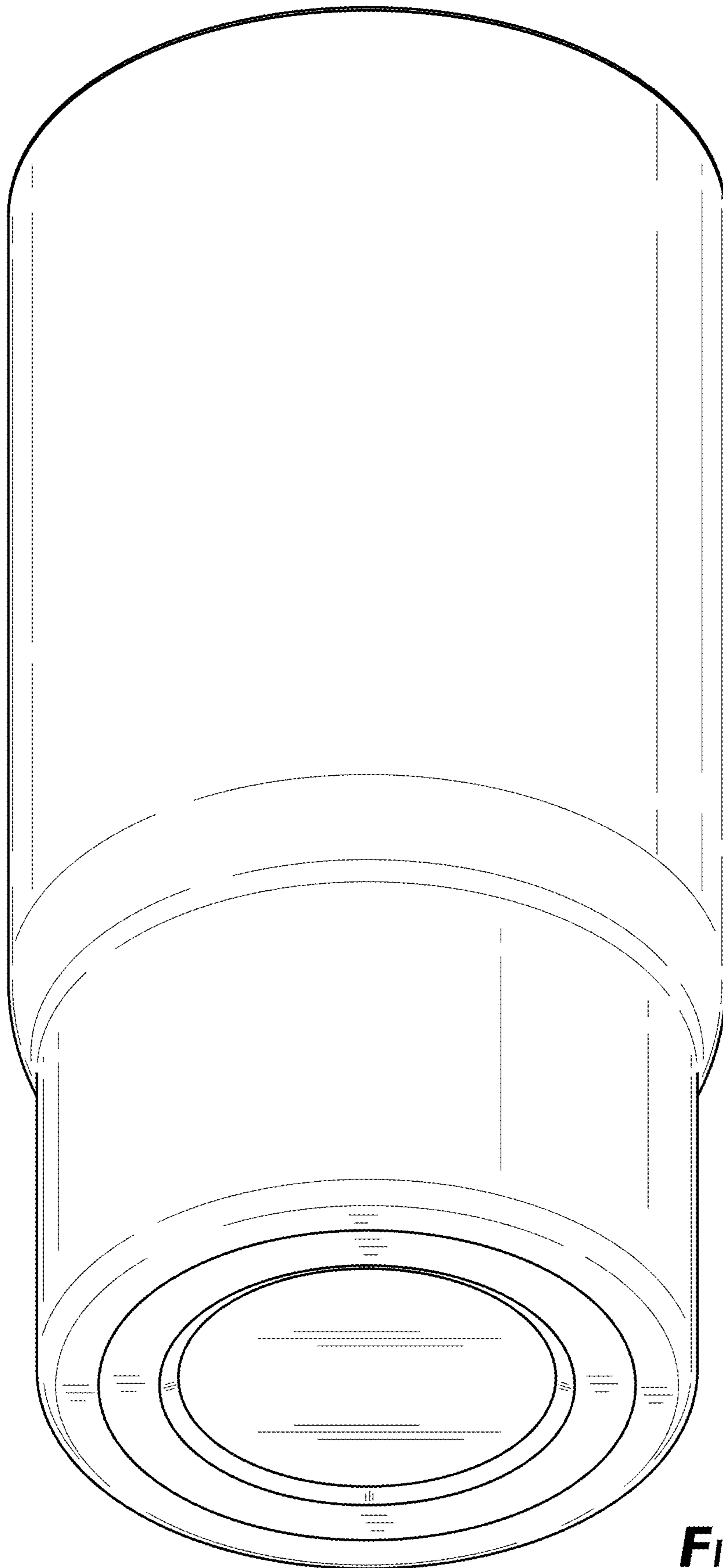

FIG.2

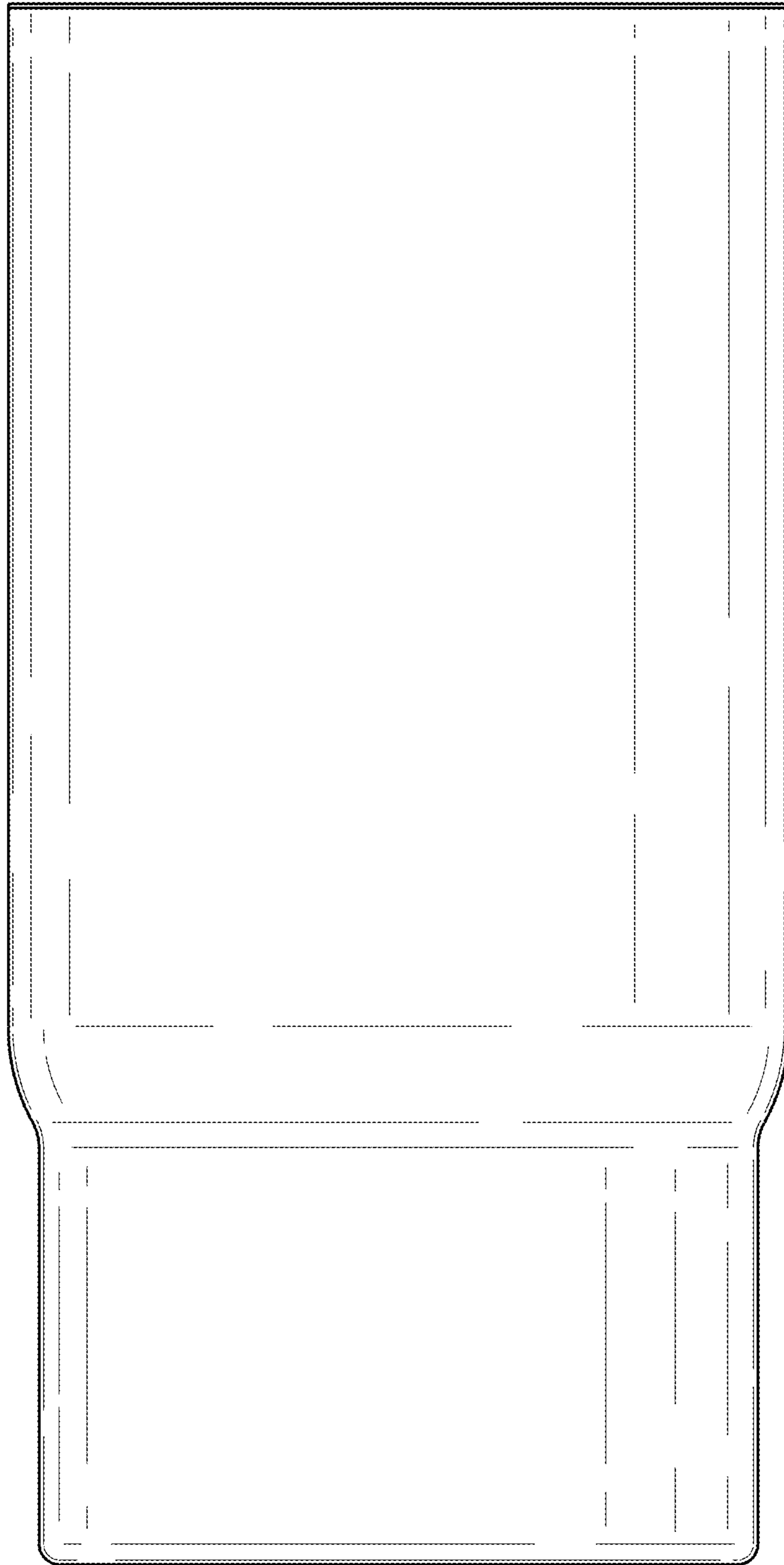

FIG.3

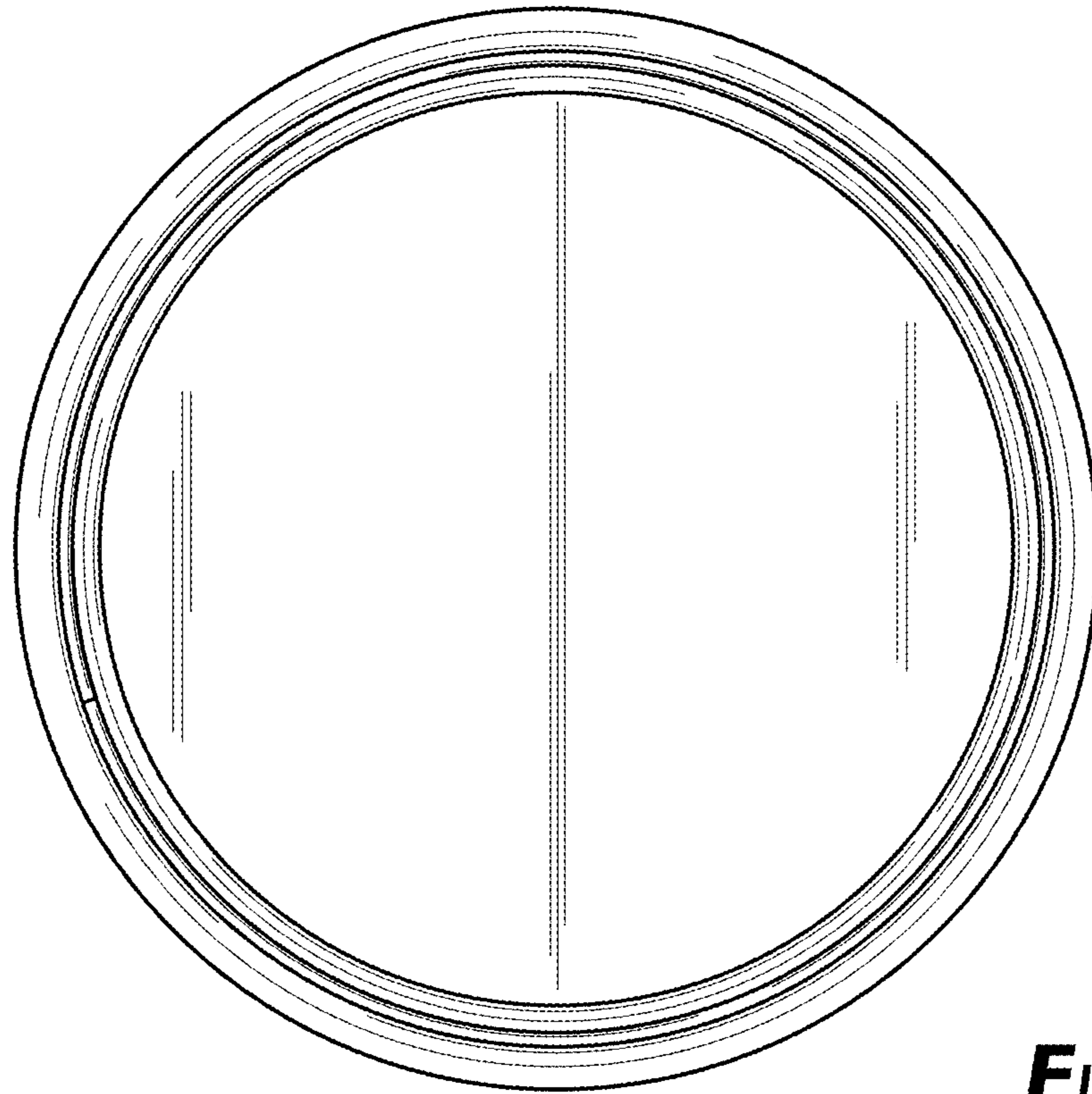

FIG.4

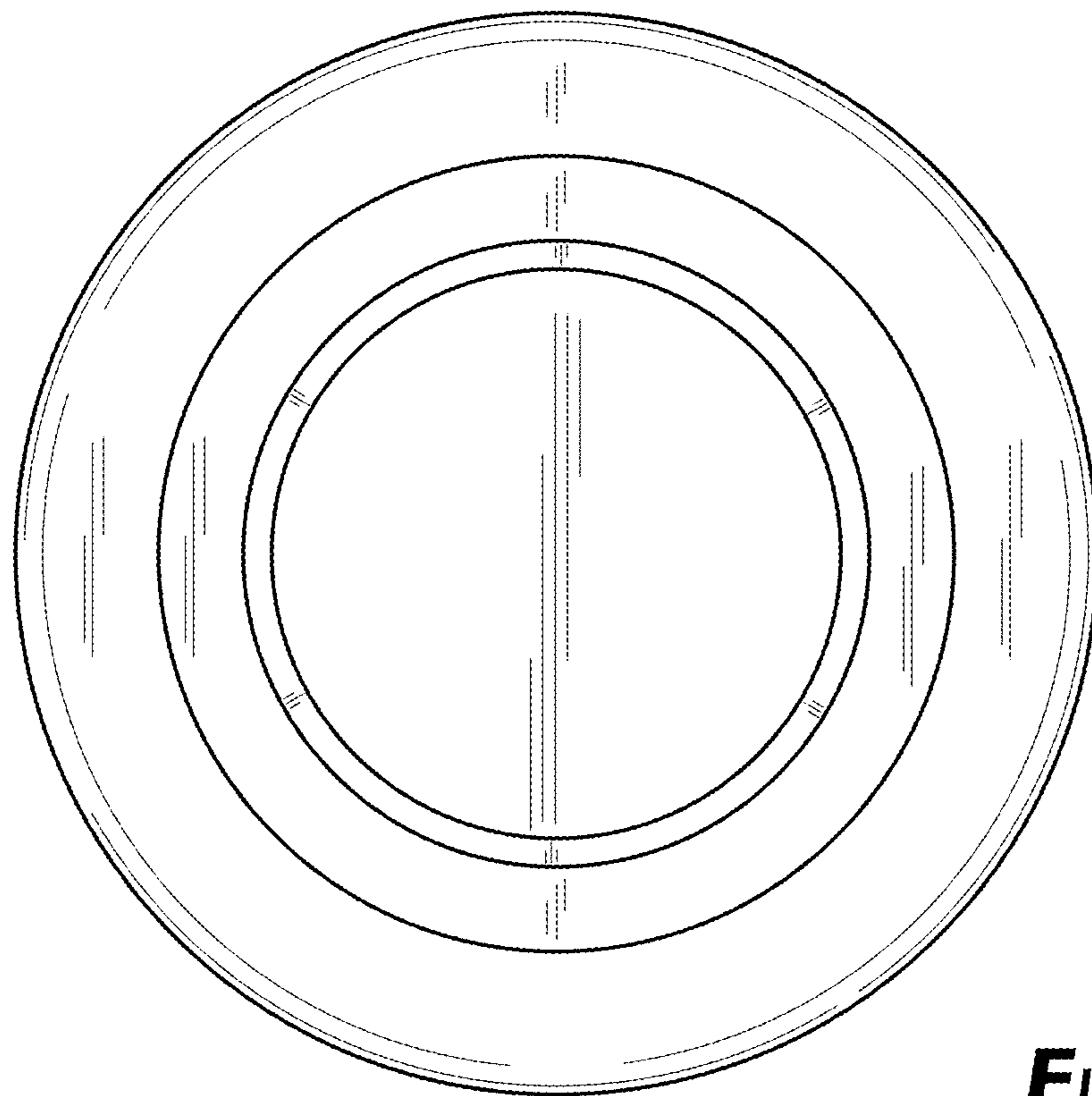

FIG.5