



US00D895340S

(12) **United States Design Patent**
Sabbagh

(10) **Patent No.:** **US D895,340 S**

(45) **Date of Patent:** **** Sep. 8, 2020**

(54) **HAMMOCK HANGING STRAP**
(71) Applicant: **Bliss Hammocks Inc.**, Hauppauge, NY (US)
(72) Inventor: **Victor Sabbagh**, Brooklyn, NY (US)
(73) Assignee: **Bliss Hammocks Inc.**, Hauppauge, NY (US)

6,357,551 B1 * 3/2002 Bogardus, III E06C 1/56
182/190
6,368,255 B1 * 4/2002 Chan-Rouse A63B 23/00
482/126
D471,006 S * 3/2003 French D3/221
D506,709 S * 6/2005 Choi D12/133
7,044,896 B2 * 5/2006 Hetrick A63B 21/00043
482/95
D536,564 S * 2/2007 McGrath D6/570
D573,381 S 7/2008 Pinholster, Jr. et al.
D581,162 S * 11/2008 Walker D3/202
7,585,197 B1 * 9/2009 Merten E06C 1/56
441/80
D651,769 S * 1/2012 Farrell D30/153
D661,175 S * 6/2012 Dahl D8/349

(**) Term: **15 Years**
(21) Appl. No.: **29/619,971**

(22) Filed: **Oct. 3, 2017**
(51) **LOC (12) Cl.** **06-06**
(52) **U.S. Cl.**
USPC **D6/718.1**
(58) **Field of Classification Search**
USPC D6/386, 387, 718, 718.1, 718.11; D8/44,
D8/356, 382, 383; D21/694, 662;
D30/153
CPC . A44C 5/0053; A63C 11/025; A63B 21/0552;
A63B 21/0555; A63B 21/0557; A63B
27/00; A62B 35/0006; A45F 3/14; A45F
3/22; A45F 3/24; E06C 1/56
See application file for complete search history.

(Continued)
Primary Examiner — Cathron C Brooks
(74) *Attorney, Agent, or Firm* — Amster, Rothstein & Ebenstein LLP

(57) **CLAIM**
The ornamental design for a hammock hanging strap, as shown and described.

DESCRIPTION
FIG. 1 is a perspective view of a hammock hanging strap; FIG. 2 is a top view thereof; FIG. 3 is a bottom view thereof; FIG. 4 is a left side view thereof, the right side being a mirror image of the left side; FIG. 5 is a front view thereof; FIG. 6 is a rear view thereof; FIG. 7 is an enlarged view of an end portion of the strap indicated at dashed box 7 in FIG. 1; and, FIG. 8 is an enlarged view of an intermediate portion of the strap indicated at dashed box 8 in FIG. 1. The hammock hanging strap is shown with symbolic break lines in FIGS. 1-4. The appearance of any abortion of the hammock hanging strap between these lines forms no part of the claimed design.

(56) **References Cited**
U.S. PATENT DOCUMENTS
4,577,726 A * 3/1986 Wheeler B63B 29/205
114/362
5,293,657 A 3/1994 DeAth
5,308,101 A * 5/1994 Monty B60D 1/182
267/74
5,688,011 A * 11/1997 Gulley B66C 1/105
294/74
D388,558 S * 12/1997 Miller D30/153
D418,301 S * 1/2000 Anderson D3/327
D437,623 S * 2/2001 Ormsby D21/662
D454,235 S * 3/2002 Kaplan D30/153

1 Claim, 4 Drawing Sheets

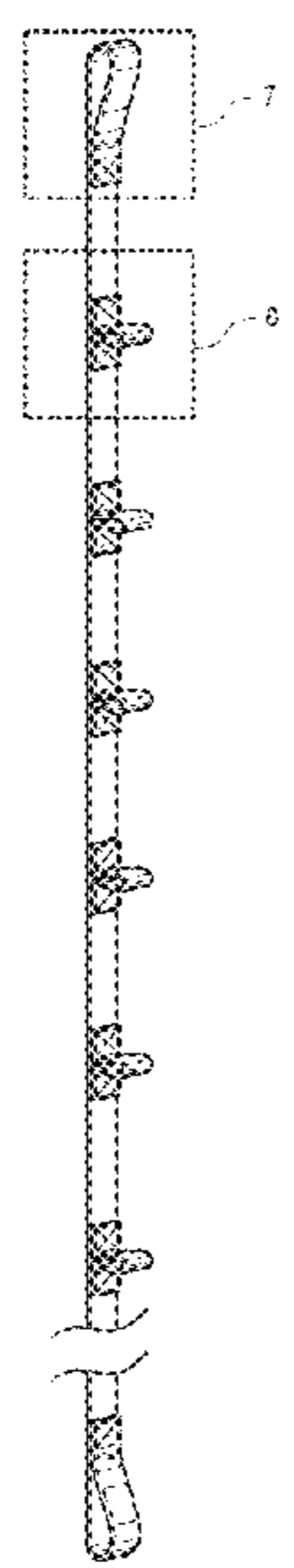

(56)

References Cited

U.S. PATENT DOCUMENTS

D666,896	S *	9/2012	Pinholster, Jr.	D8/356
D676,091	S *	2/2013	Henniger	D21/662
8,505,683	B1 *	8/2013	Dirrig	A63B 27/00 182/9
D695,470	S	12/2013	Reed	
8,696,521	B2 *	4/2014	Wu	A63B 7/02 482/35
D712,555	S *	9/2014	Berg	D24/190
8,920,084	B2 *	12/2014	Dahl	D07B 1/18 410/96
8,944,976	B2 *	2/2015	Crowell	A63B 21/068 482/125
9,003,579	B1 *	4/2015	Pinholster, Jr.	A45F 3/22 5/120
9,022,908	B2 *	5/2015	Crowell	A63B 21/0555 482/121
9,427,622	B2 *	8/2016	Thrasher-Rudd	A63B 21/4034
D771,960	S *	11/2016	McDonough	D6/328
9,630,043	B2 *	4/2017	Foster	A63B 21/0023
9,907,389	B2 *	3/2018	Conlin	A45F 3/24
10,143,612	B2 *	12/2018	Foster	A61H 1/0274
2004/0145202	A1 *	7/2004	Dela Paz	A45F 3/14 294/157

* cited by examiner

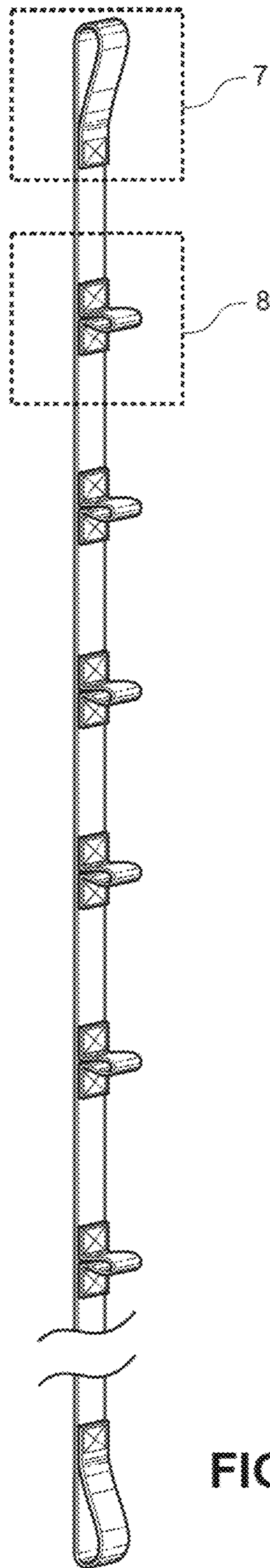

FIG. 1

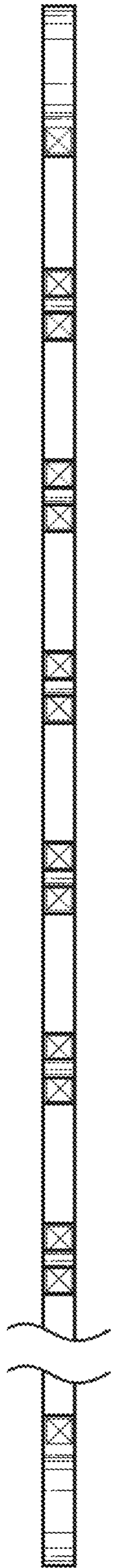

FIG. 2

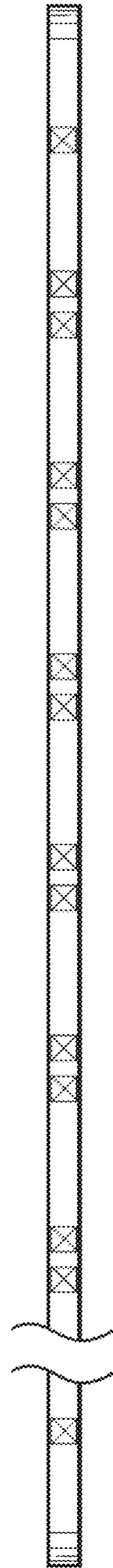

FIG. 3

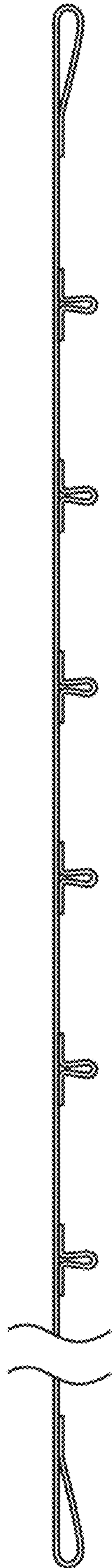

FIG. 4



FIG. 5



FIG. 6

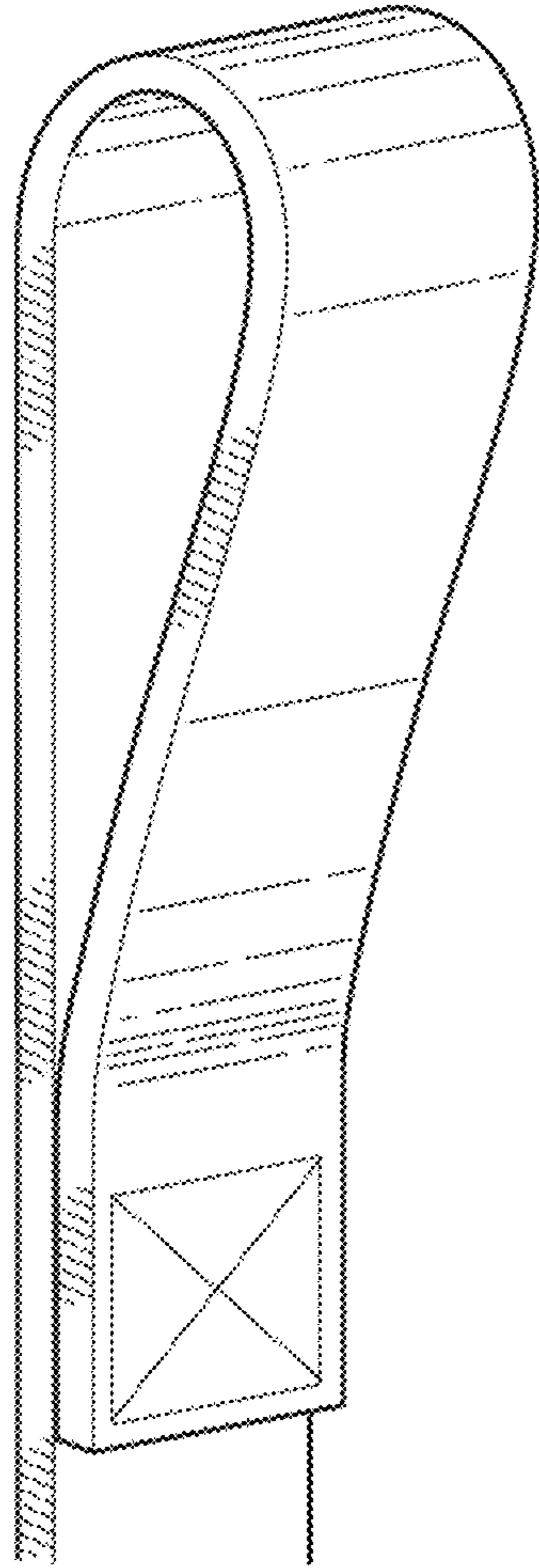

FIG. 7

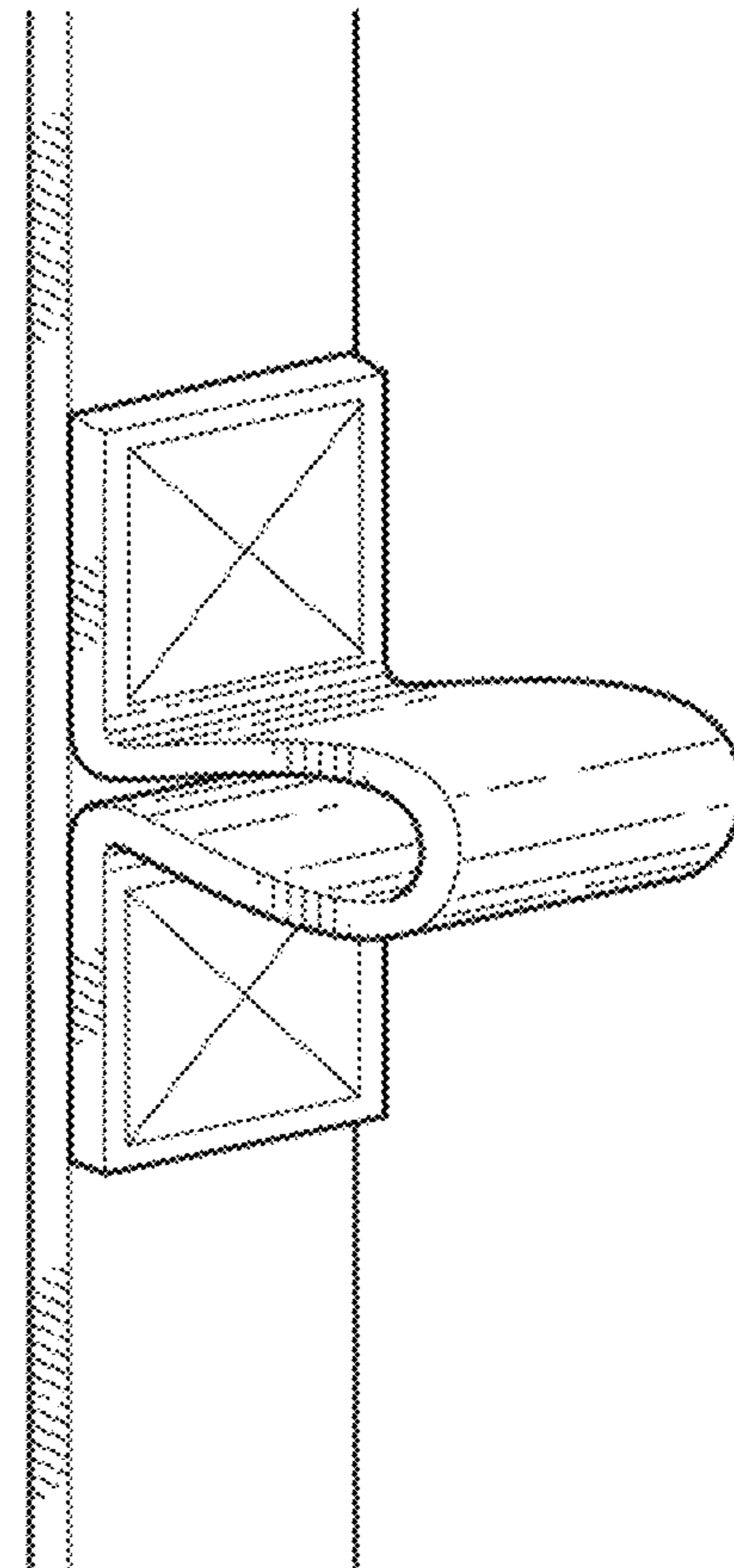

FIG. 8