



US00D895274S

(12) **United States Design Patent** (10) **Patent No.:** **US D895,274 S**
Dara (45) **Date of Patent:** **** Sep. 8, 2020**

(54) **PADDLE ATTACHMENT**
(71) Applicant: **Jonathan Dara**, Wendell, NC (US)
(72) Inventor: **Jonathan Dara**, Wendell, NC (US)
(**) Term: **15 Years**

8,196,792 B2 * 6/2012 Clifton, Jr. A45F 5/00
224/661
D724,314 S * 3/2015 Faifer D3/222
D807,029 S * 1/2018 Resca D3/222
D828,019 S * 9/2018 Dara D3/222

(21) Appl. No.: **29/669,063**
(22) Filed: **Nov. 5, 2018**
(51) **LOC (12) Cl.** **03-01**
(52) **U.S. Cl.**
USPC **D3/222**
(58) **Field of Classification Search**
USPC D3/222-223; D8/356; D22/108-109;
224/191-193, 197-198, 238, 243-244,
224/676-679, 661, 911-912; 248/118.3,
248/222.51, 689
CPC A45F 5/00; A45F 5/02; A45F 5/021; A45F
2005/008; A45F 2200/0591; A45F
2003/006; F41C 33/0227; F41C 33/046;
F41C 33/041; F41C 33/0263; F41C
33/045; Y10S 224/912
See application file for complete search history.

OTHER PUBLICATIONS

ProDraw Paddle OWB, VEDDERholsters.com (Year: 2020).*

* cited by examiner

Primary Examiner — Catherine R Oliver-Garcia

(57) **CLAIM**

The ornamental design for a paddle attachment, as shown and described.

DESCRIPTION

FIG. 1 is a top front perspective view of a paddle attachment showing my new design;
FIG. 2 is a bottom front perspective view thereof;
FIG. 3 is a top rear perspective view thereof;
FIG. 4 is a bottom rear perspective view thereof;
FIG. 5 is a front view thereof;
FIG. 6 is a rear view thereof;
FIG. 7 is a left view thereof;
FIG. 8 is a right view thereof;
FIG. 9 is a top view thereof; and,
FIG. 10 is a bottom view thereof.

(56) **References Cited**

U.S. PATENT DOCUMENTS

D453,068 S * 1/2002 Rogers D3/222
D507,104 S * 7/2005 Gregory D3/222
D508,318 S * 8/2005 Gregory D3/222
D592,850 S * 5/2009 Shen D3/222
D603,160 S * 11/2009 Zusman D3/222
D653,848 S * 2/2012 Alstrom D3/222

1 Claim, 10 Drawing Sheets

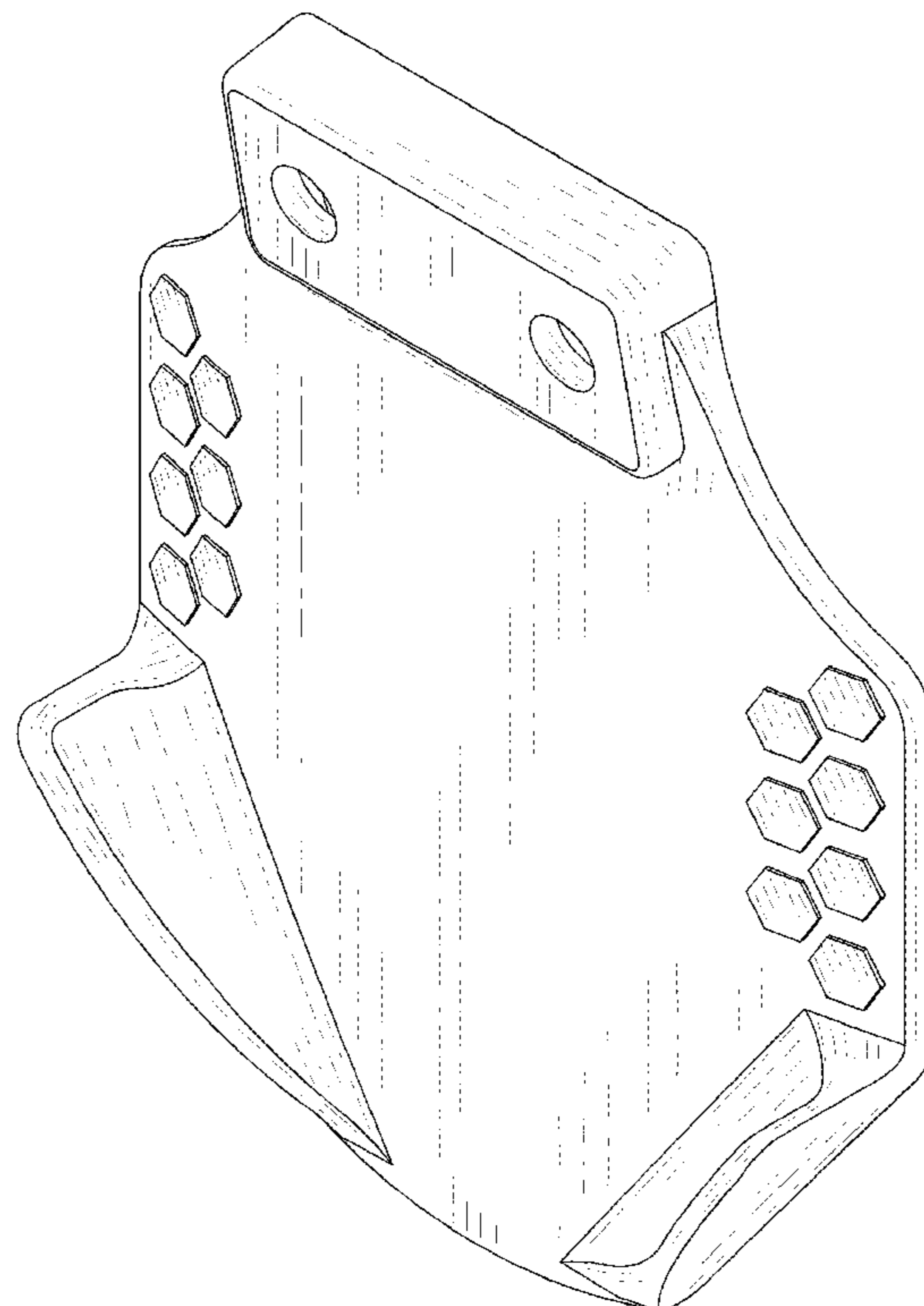

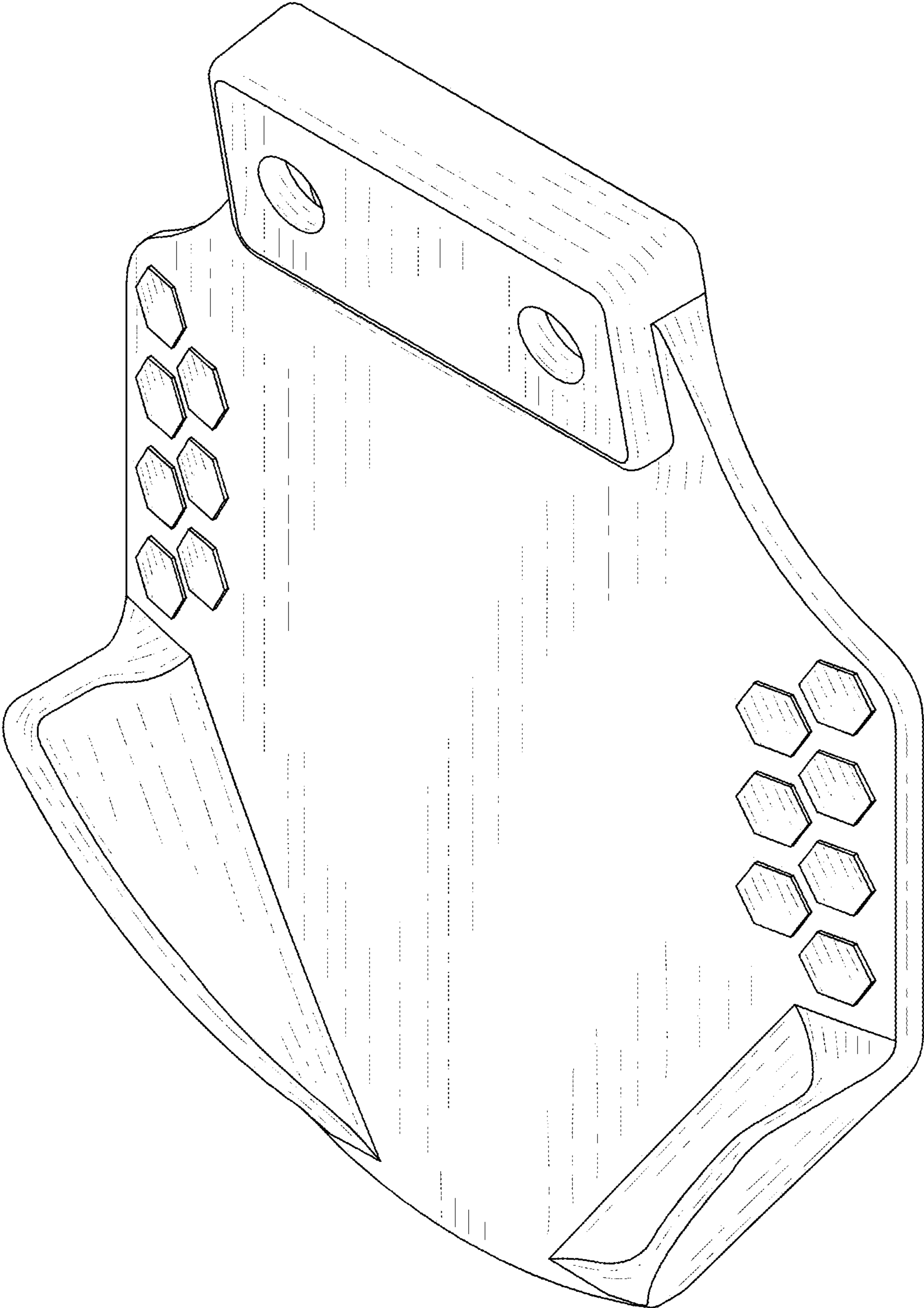

FIG 1

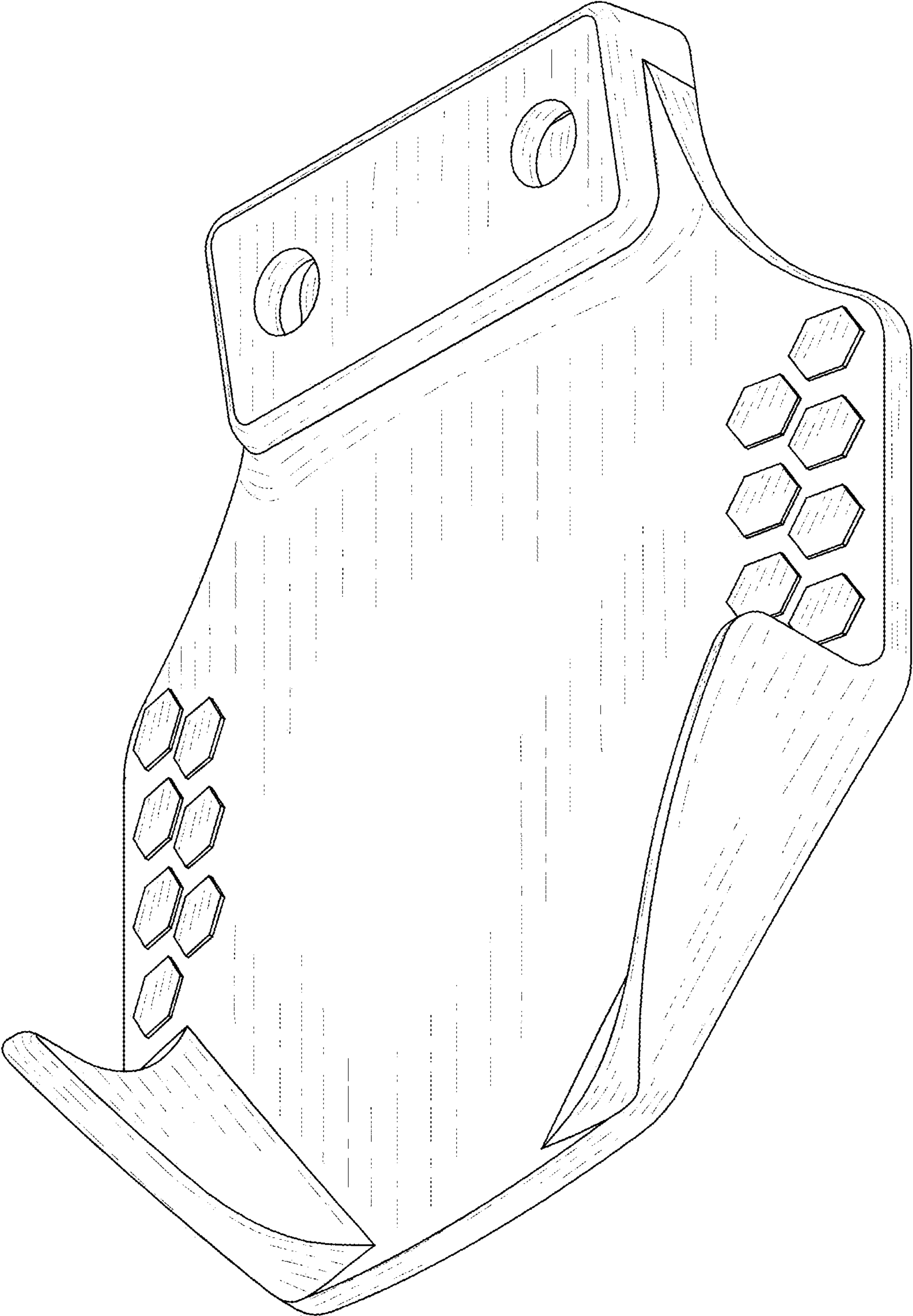

FIG 2

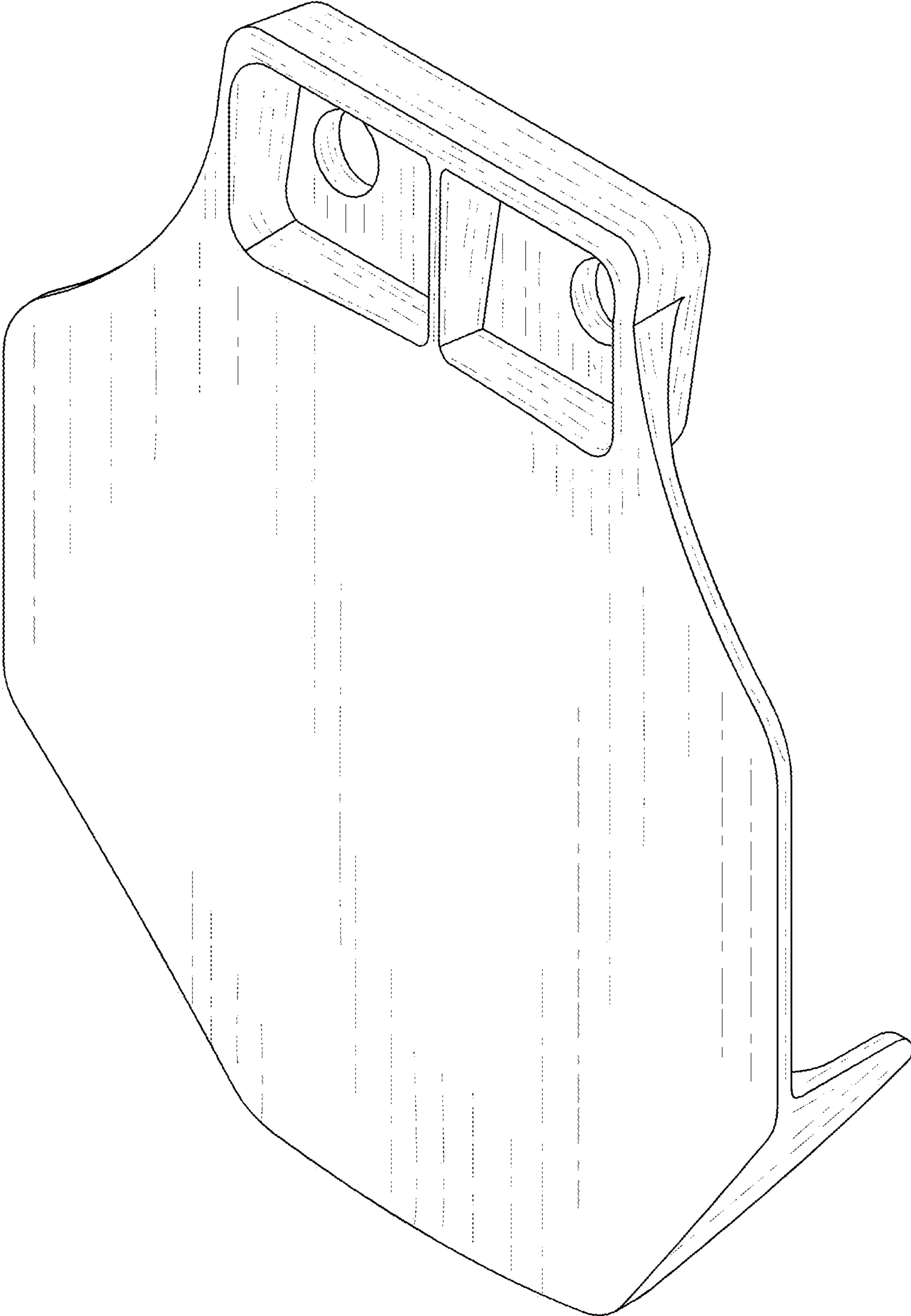

FIG 3

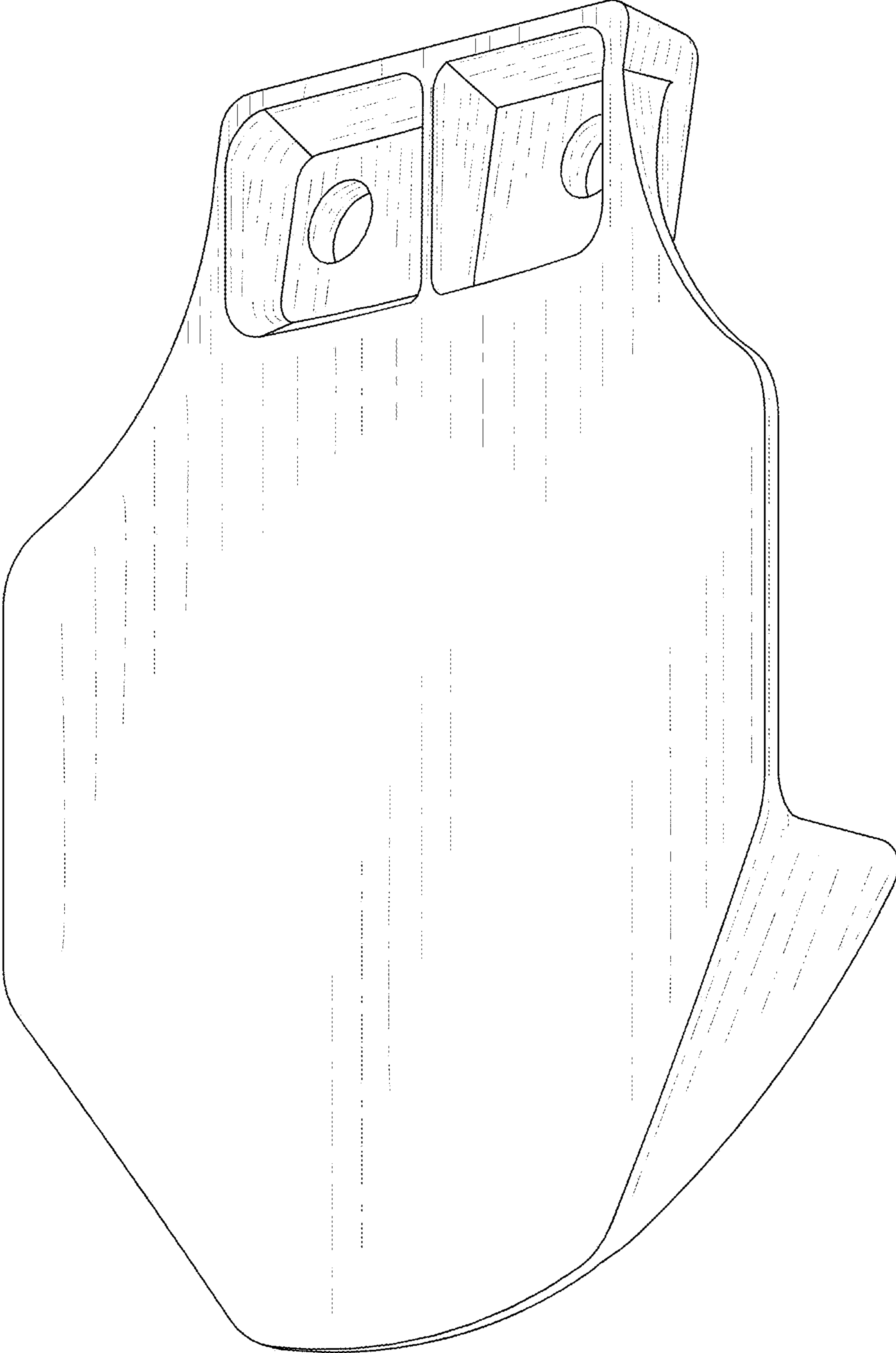

FIG 4

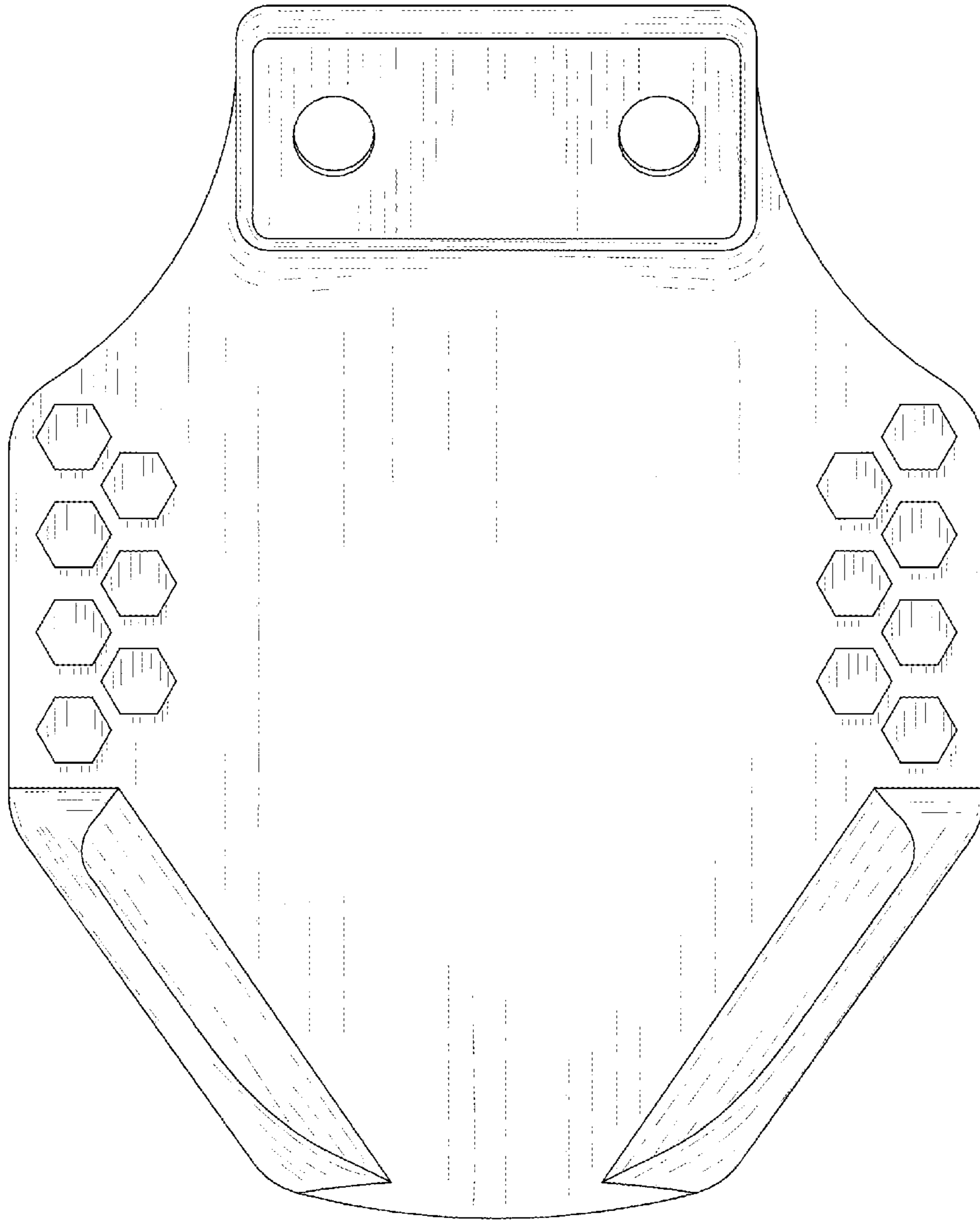

FIG 5

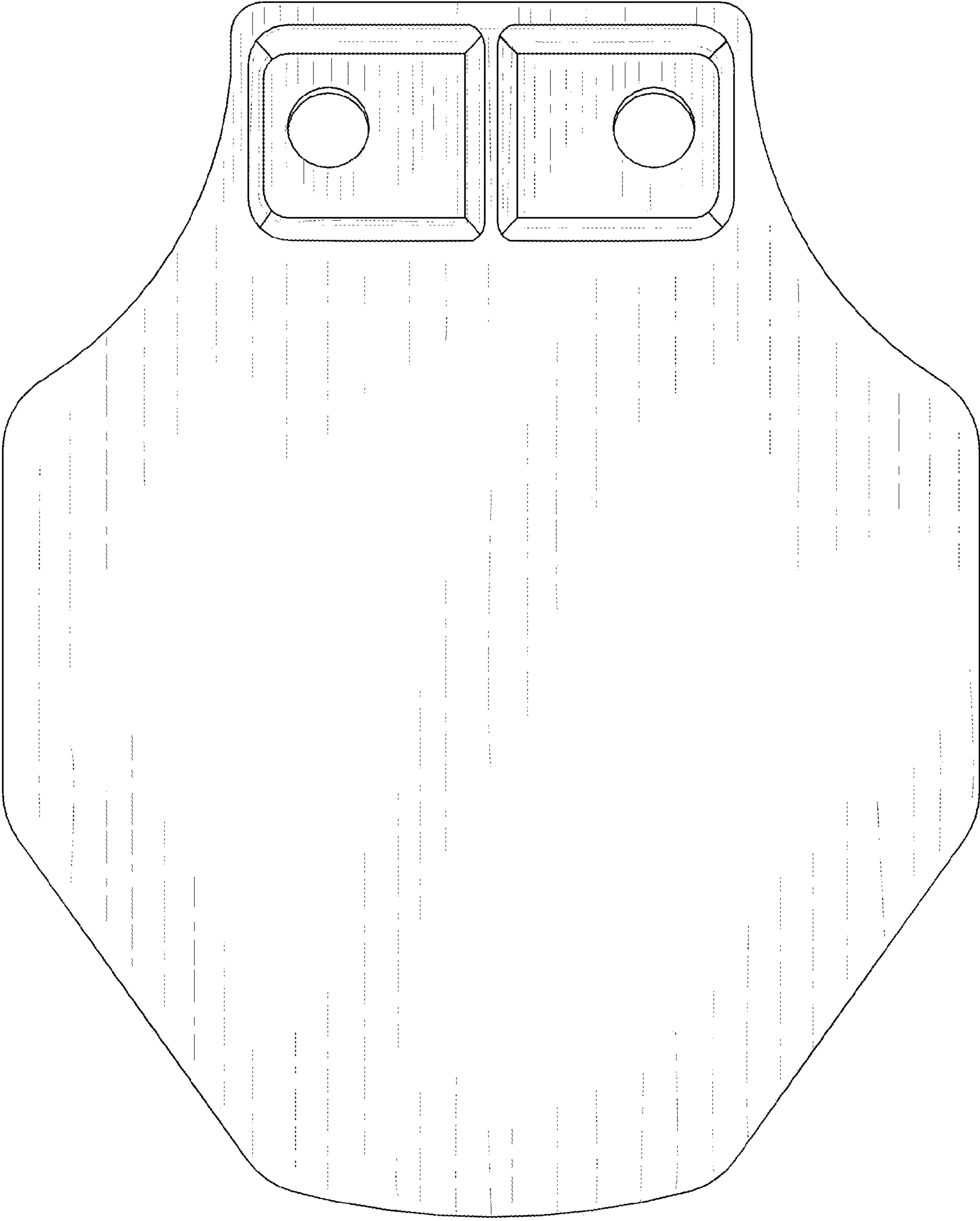

FIG 6

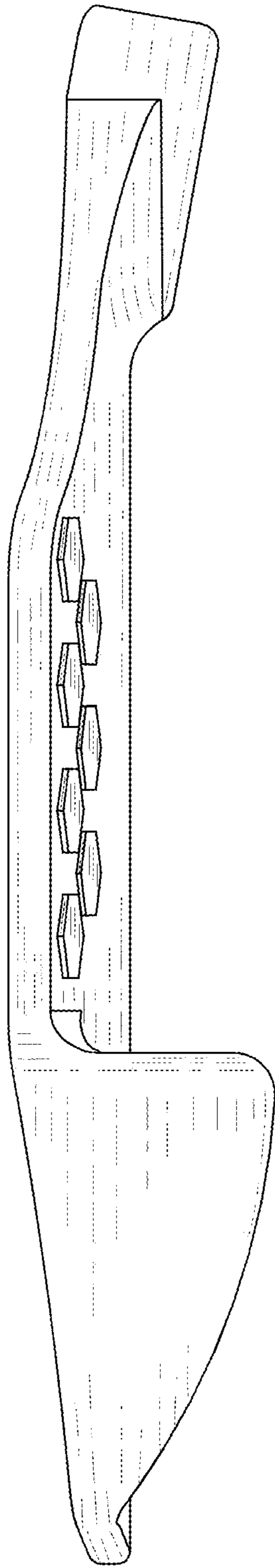

FIG 7

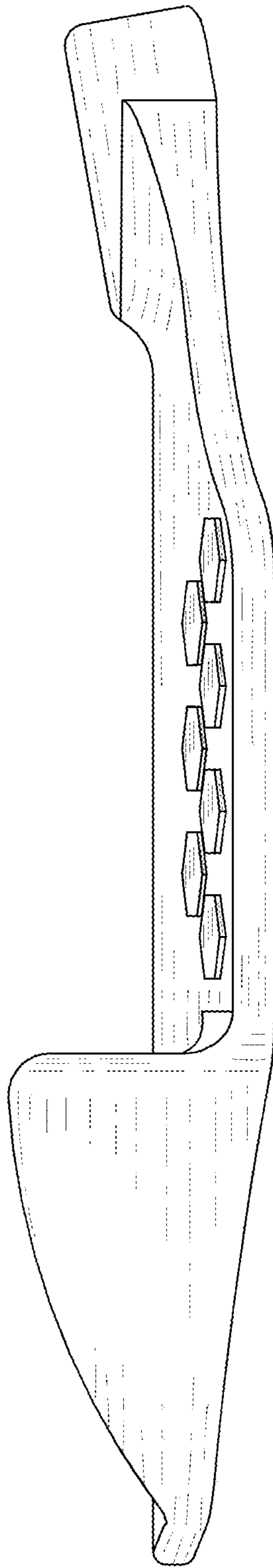

FIG 8

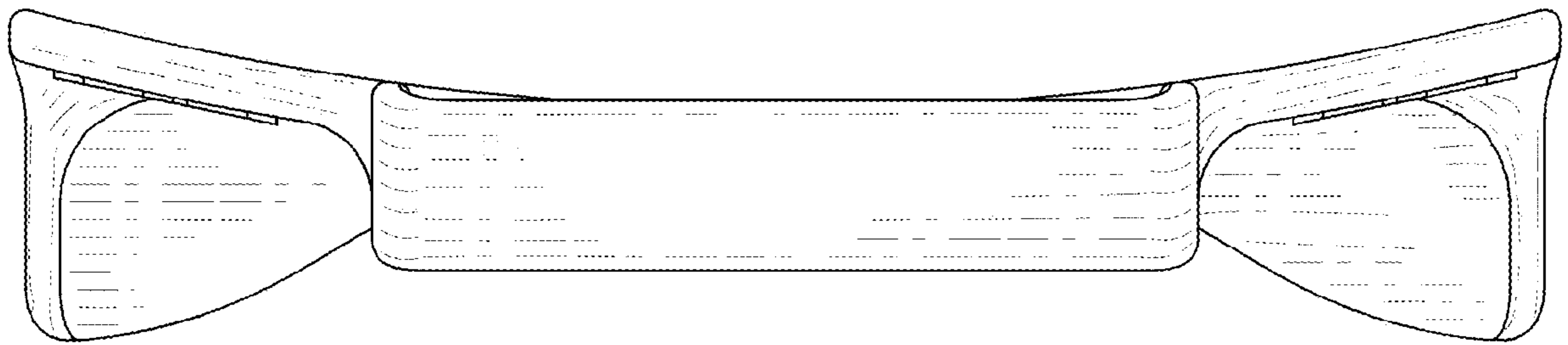

FIG 9

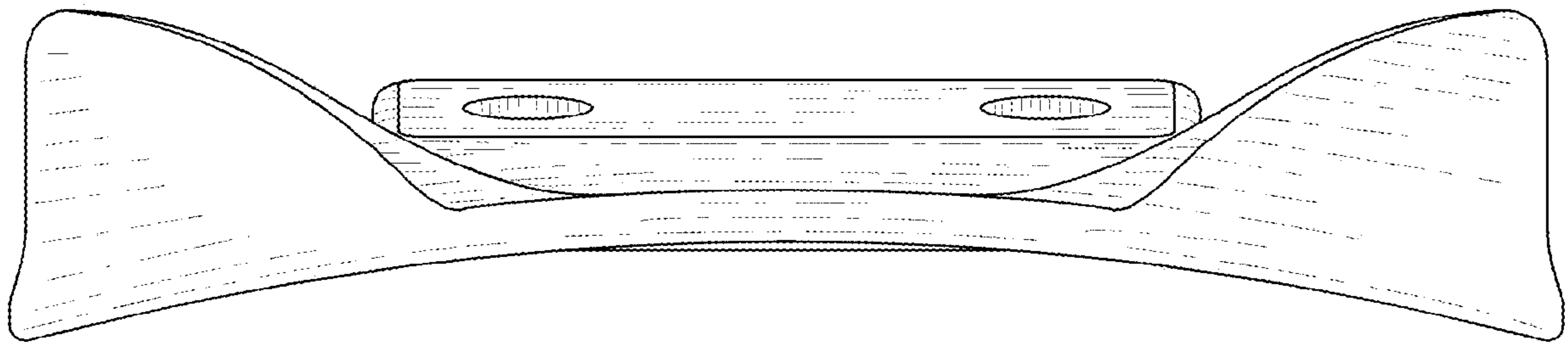

FIG 10