



US00D895225S

(12) **United States Design Patent**
Smith

(10) **Patent No.:** **US D895,225 S**

(45) **Date of Patent:** **** Sep. 1, 2020**

(54) **GUN SAFE**

(71) Applicant: **Carl P. Smith**, Allerton, IL (US)

(72) Inventor: **Carl P. Smith**, Allerton, IL (US)

(**) Term: **15 Years**

(21) Appl. No.: **29/619,137**

(22) Filed: **Sep. 27, 2017**

Related U.S. Application Data

(62) Division of application No. 29/557,702, filed on Mar. 10, 2016, now Pat. No. Des. 808,109.

(51) **LOC (12) Cl.** **99-00**

(52) **U.S. Cl.**
USPC **D99/28**

(58) **Field of Classification Search**
USPC D99/28, 34, 35, 36, 43, 99; 109/1 R,
109/1 V, 2, 45; 902/9, 30; 235/100;
206/317, 527, 235; 312/400, 409
(Continued)

(56) **References Cited**

U.S. PATENT DOCUMENTS

166,107 A * 7/1875 Hyatt E05G 1/08
109/53
3,330,612 A 7/1967 Masterson et al.
(Continued)

OTHER PUBLICATIONS

Liberty Safe, Safe Catalog 2016, REV. Jan. 4, 2016, p. 32, Liberty Safe and Security Products, Inc. (<http://www.libertysafe.com/images/downloads/safe-catalog.pdf>).

Primary Examiner — Elizabeth J Oswecki

(74) *Attorney, Agent, or Firm* — Wendy Thai

(57) **CLAIM**

The ornamental design for a gun safe, as shown and described.

DESCRIPTION

FIG. 1 is a front view of a first embodiment of a gun safe, showing my new design;
FIG. 2 is a front, right side perspective view thereof;
FIG. 3 is a right side elevation view thereof;
FIG. 4 is a rear elevation view thereof;
FIG. 5 is a left side elevation view thereof;
FIG. 6 is a top, front, right side perspective view thereof;
FIG. 7 is a front, bottom, right side perspective view thereof;
FIG. 8 is a top plan view thereof;
FIG. 9 is a bottom plan view thereof;
FIG. 10 is a front view of a second embodiment of a gun safe, showing my new design;
FIG. 11 is a right side elevation view thereof;
FIG. 12 is a rear elevation view thereof;
FIG. 13 is a left side elevation view thereof;
FIG. 14 is a left side, front perspective view thereof;
FIG. 15 is a top, front, left side perspective view thereof;
FIG. 16 is a front, bottom, left side perspective view thereof;
FIG. 17 is a top plan view thereof;
FIG. 18 is a bottom plan view thereof;
FIG. 19 is a front view of a third embodiment of a gun safe, showing my new design;
FIG. 20 is a front, right side perspective view thereof;
FIG. 21 is a right side elevation view thereof;
FIG. 22 is a rear elevation view thereof;
FIG. 23 is a left side elevation view thereof;
FIG. 24 is a top, front, right side perspective view thereof;
FIG. 25 is a top plan view thereof;
FIG. 26 is a bottom plan view thereof;
FIG. 27 is a front view of a fourth embodiment of a gun safe, showing my new design;
FIG. 28 is a right side elevation view thereof;
FIG. 29 is a rear elevation view thereof;
FIG. 30 is a front, left side perspective view thereof;
FIG. 31 is a left side elevation view thereof;
FIG. 32 is a top, front, left side perspective view thereof;
FIG. 33 is a top plan view thereof; and,
FIG. 34 is a bottom plan view thereof.
The broken lines showing a circular lock in the FIGURES form no part of the claimed design.

1 Claim, 7 Drawing Sheets

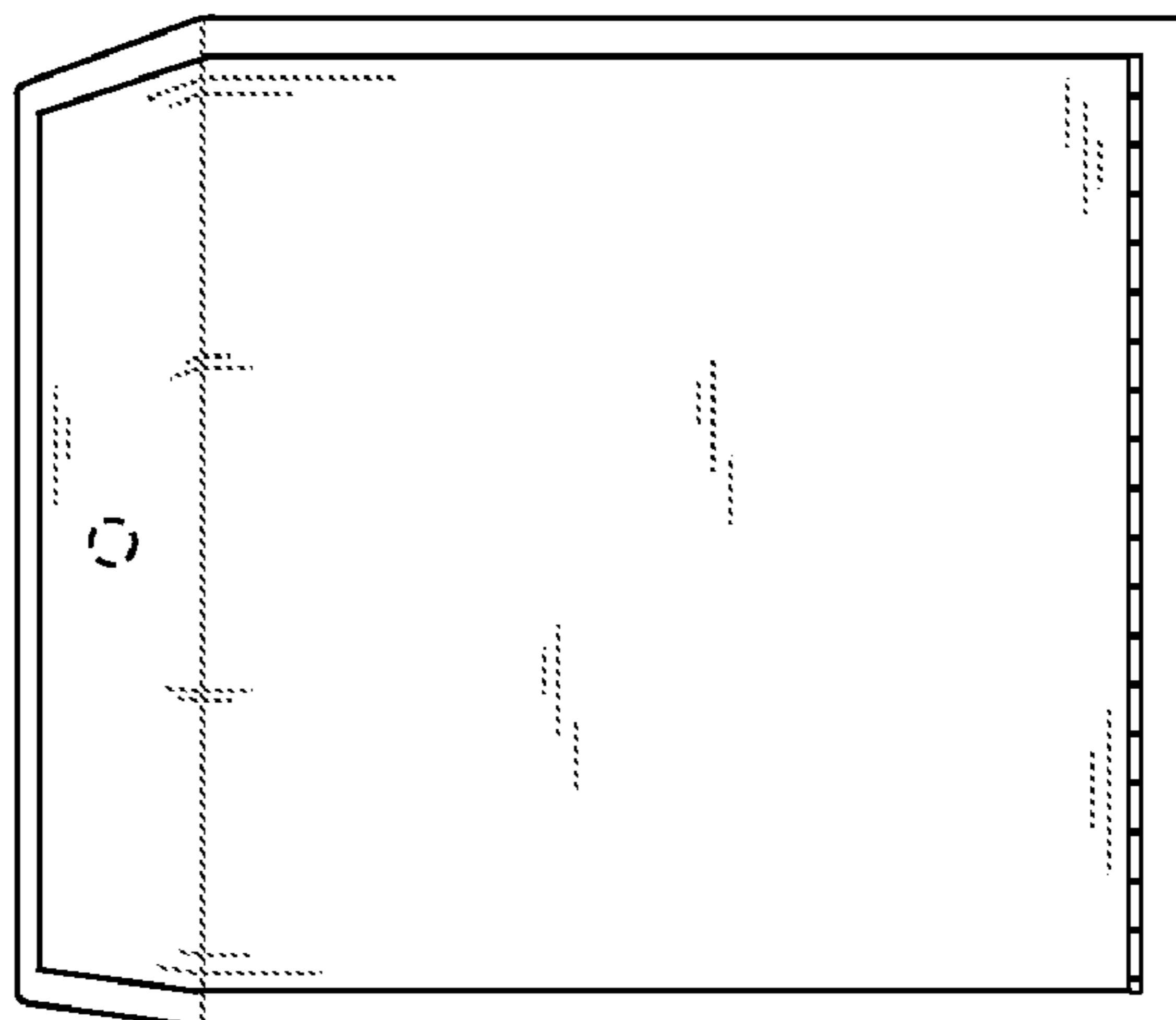
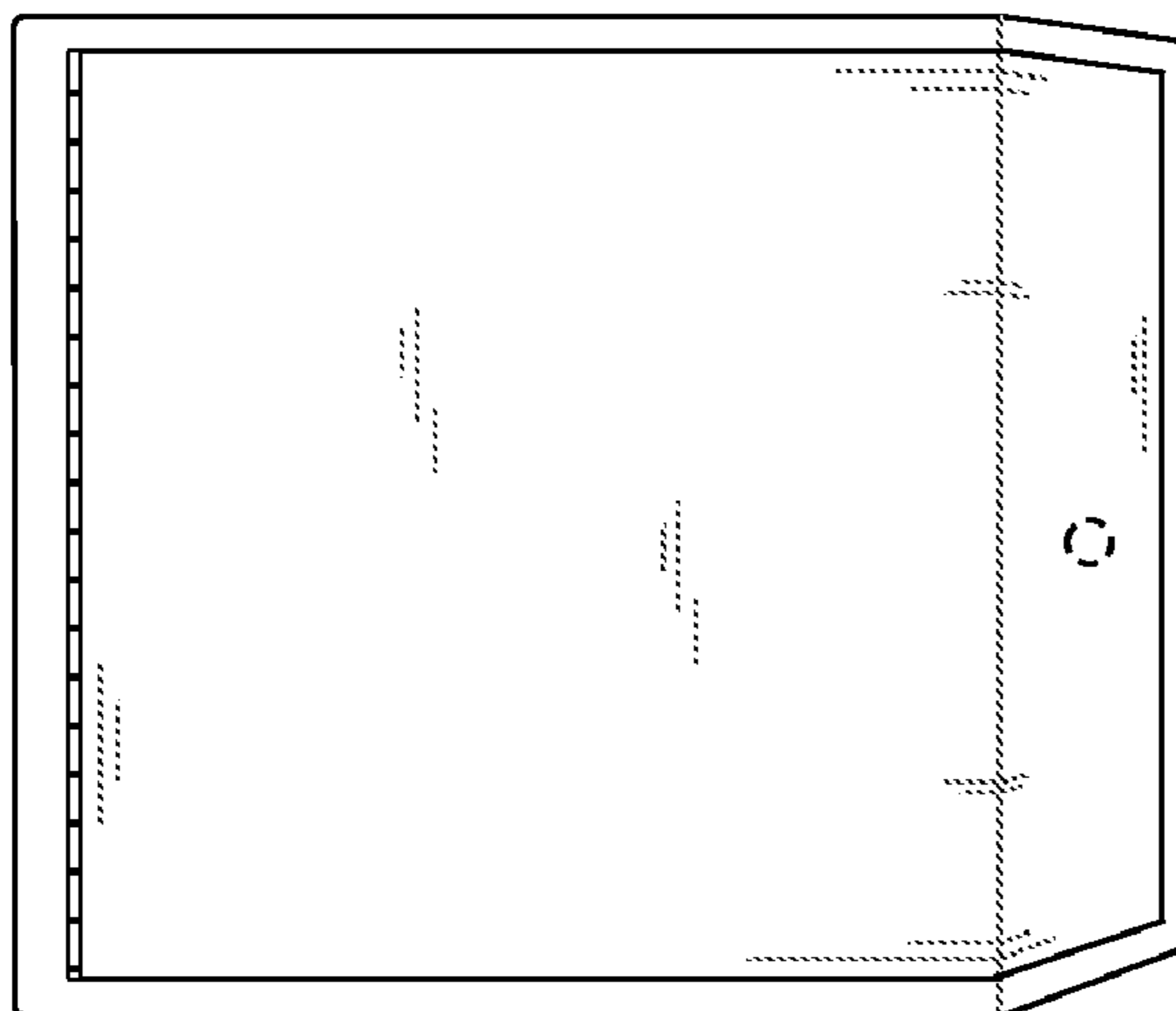

(58) **Field of Classification Search**
 CPC E05B 65/0075; F42B 39/00; F42B 39/002;
 F42B 39/14; F42B 39/18; F42B 39/22;
 F42B 39/24; F42B 39/20; F42B 39/26;
 E05G 1/00; E05G 1/005; E05G 1/024;
 E05G 5/00; E05G 5/02; E05G 2700/00;
 E05G 2700/02; E05G 2700/04; G07F
 17/10; G07F 9/06; G07F 9/003; G07F
 9/002; G07F 9/004; G07F 9/008; G07D
 11/0006

See application file for complete search history.

(56) **References Cited**

U.S. PATENT DOCUMENTS

3,731,818 A 5/1973 Young
 4,383,721 A 5/1983 Knaack et al.
 5,056,342 A 10/1991 Prinz
 6,033,046 A 3/2000 Lambright
 6,405,861 B1 6/2002 Siler
 D493,270 S * 7/2004 Lynch D99/28
 6,843,081 B1 * 1/2005 Painter F41C 33/06
 109/45
 6,865,993 B2 3/2005 Bartel
 7,025,203 B2 * 4/2006 Schonenbach F41C 33/06
 206/315.11
 D569,073 S * 5/2008 Osiecki D99/28

D586,525 S * 2/2009 Pendleton D99/28
 7,546,920 B1 * 6/2009 Horn F41C 33/06
 206/317
 D598,175 S * 8/2009 Pendleton D6/668
 D617,974 S * 6/2010 Alfeld, Sr. D99/28
 D619,775 S * 7/2010 Pendleton D6/668
 D620,675 S * 7/2010 Doettingling D99/28
 D623,824 S * 9/2010 Pendleton D6/668
 D651,785 S * 1/2012 Martin D99/28
 D659,944 S * 5/2012 Pendleton D99/28
 8,474,923 B2 7/2013 Pendleton
 D714,015 S * 9/2014 Hyde D99/28
 D728,189 S * 4/2015 Suggs D99/28
 8,997,994 B1 4/2015 Jung
 D729,490 S * 5/2015 Pannier D99/43
 D730,015 S * 5/2015 Osiecki D99/28
 D731,739 S * 6/2015 Hine D99/28
 D732,264 S * 6/2015 Hine D99/28
 D732,265 S * 6/2015 Osiecki D99/28
 D744,190 S * 11/2015 Pannier D99/43
 D744,715 S * 12/2015 Suggs D99/28
 D748,365 S * 1/2016 Nelson D99/28
 9,278,649 B2 3/2016 McGoldrick
 D758,690 S * 6/2016 Miller D99/28
 D774,272 S * 12/2016 Suggs D99/28
 10,060,177 B2 8/2018 Smith
 2003/0041787 A1 3/2003 Gerstenkorn
 2008/0203860 A1 8/2008 Myers
 2010/0282136 A1 11/2010 Stanley

* cited by examiner

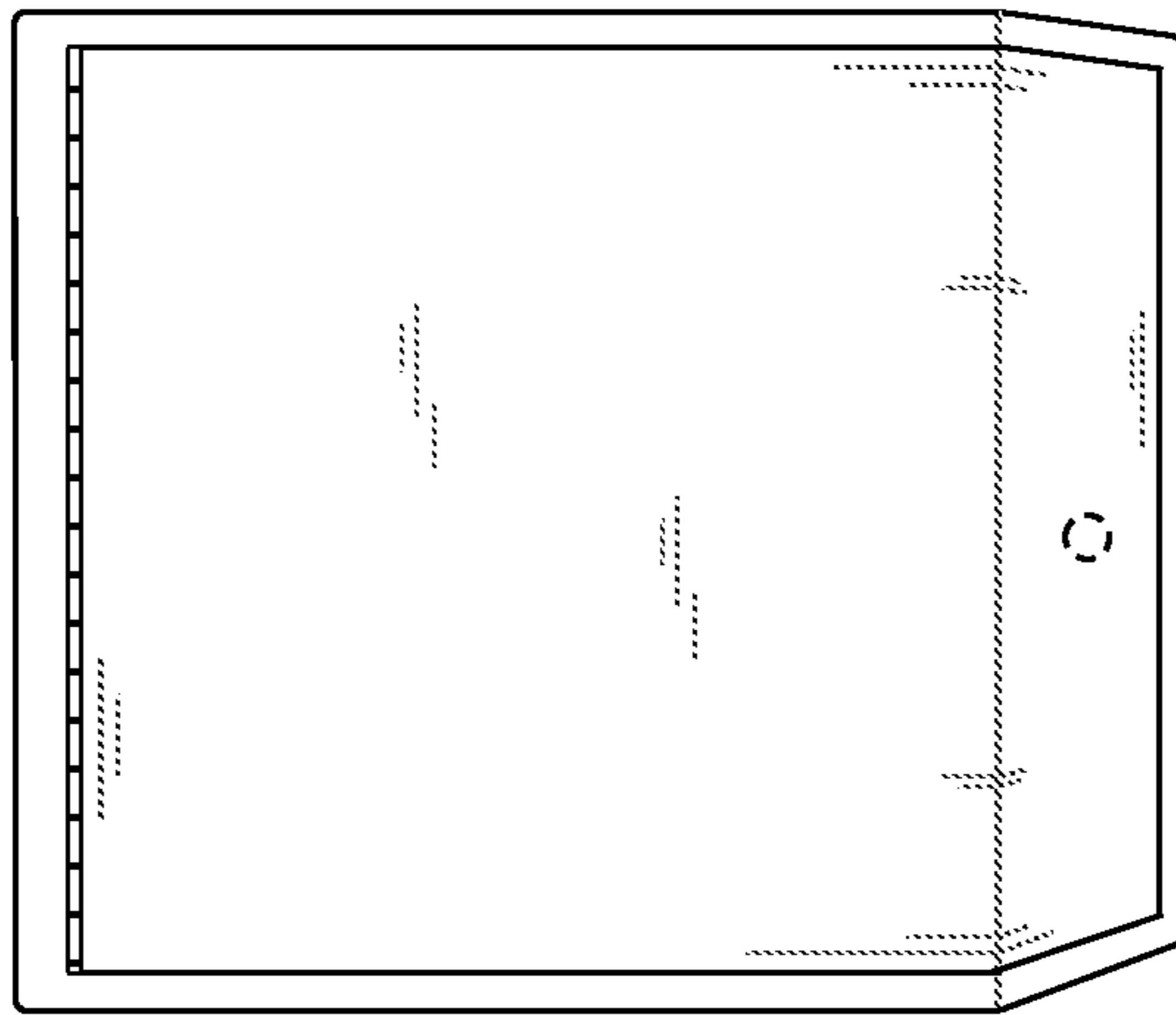

Fig. 1

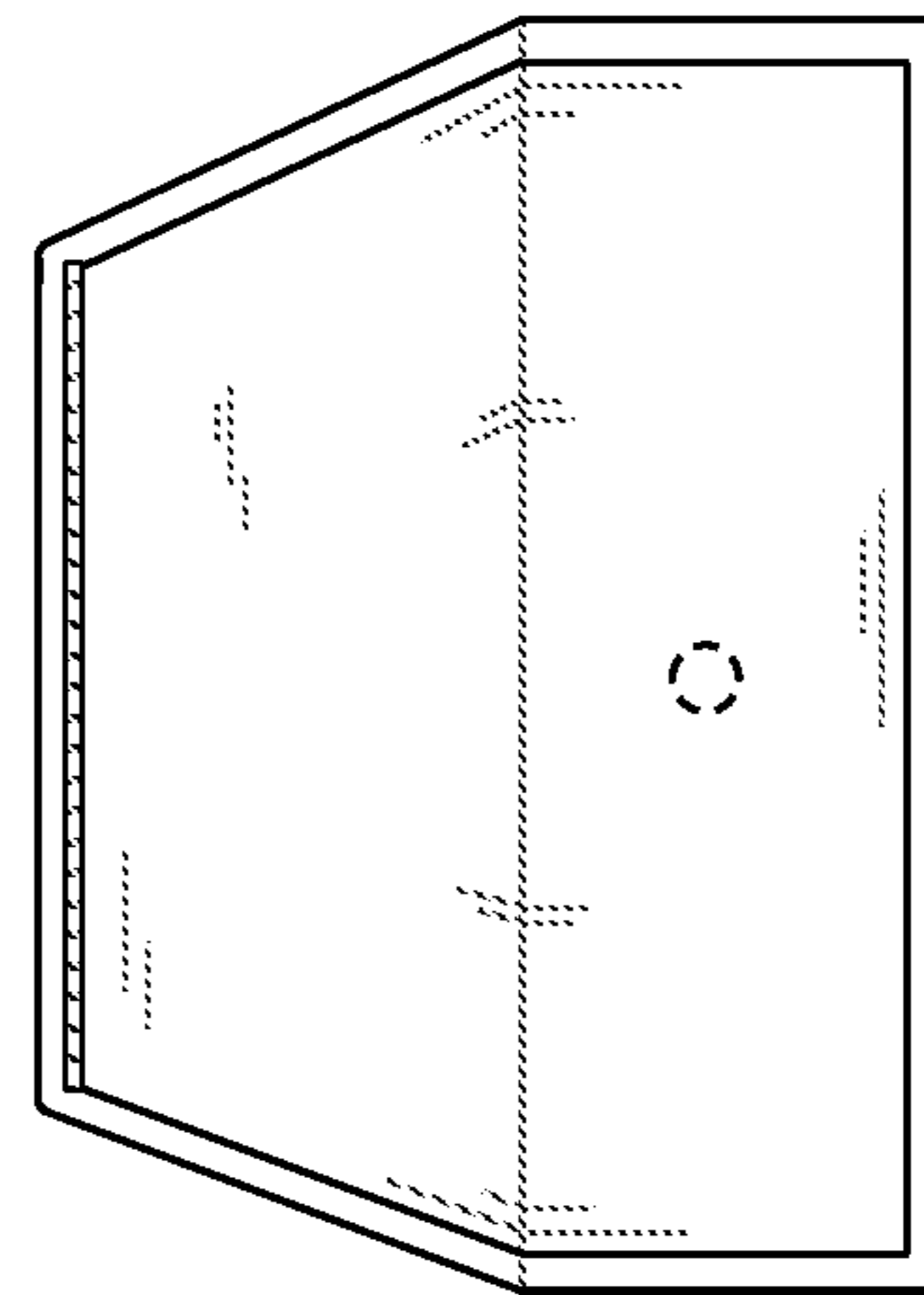

Fig. 2

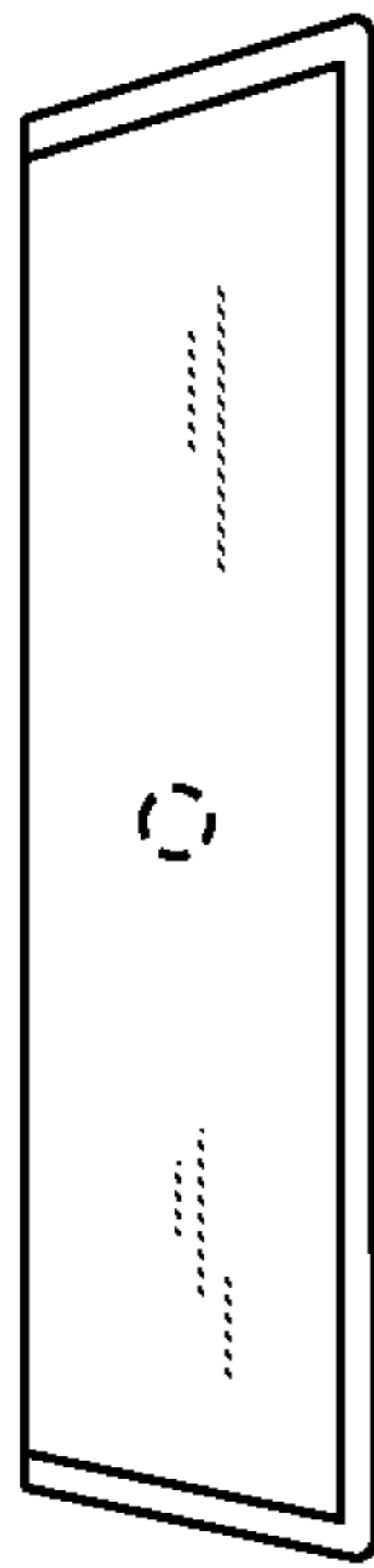

Fig. 3

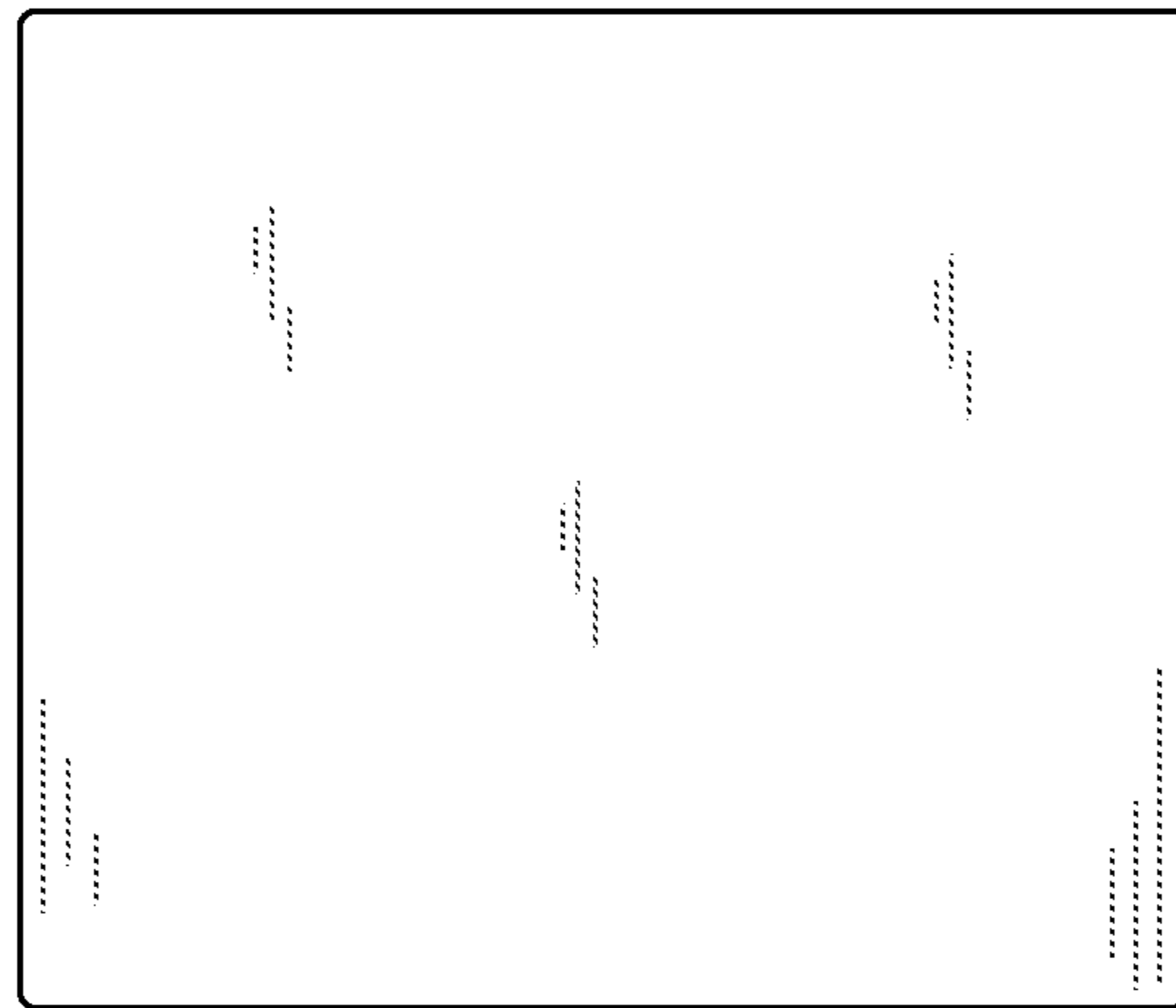

Fig. 4

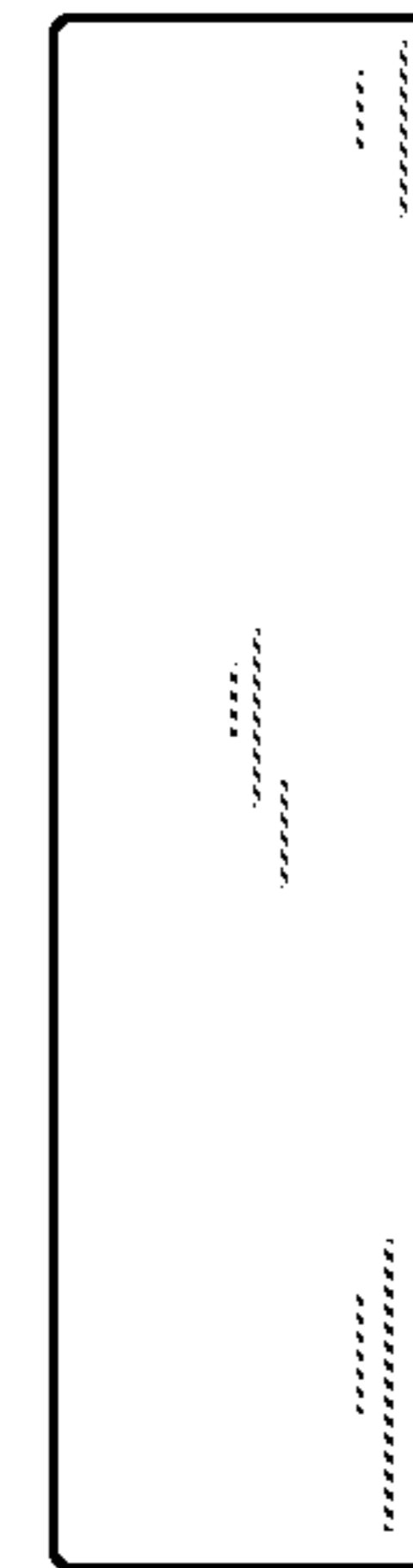

Fig. 5

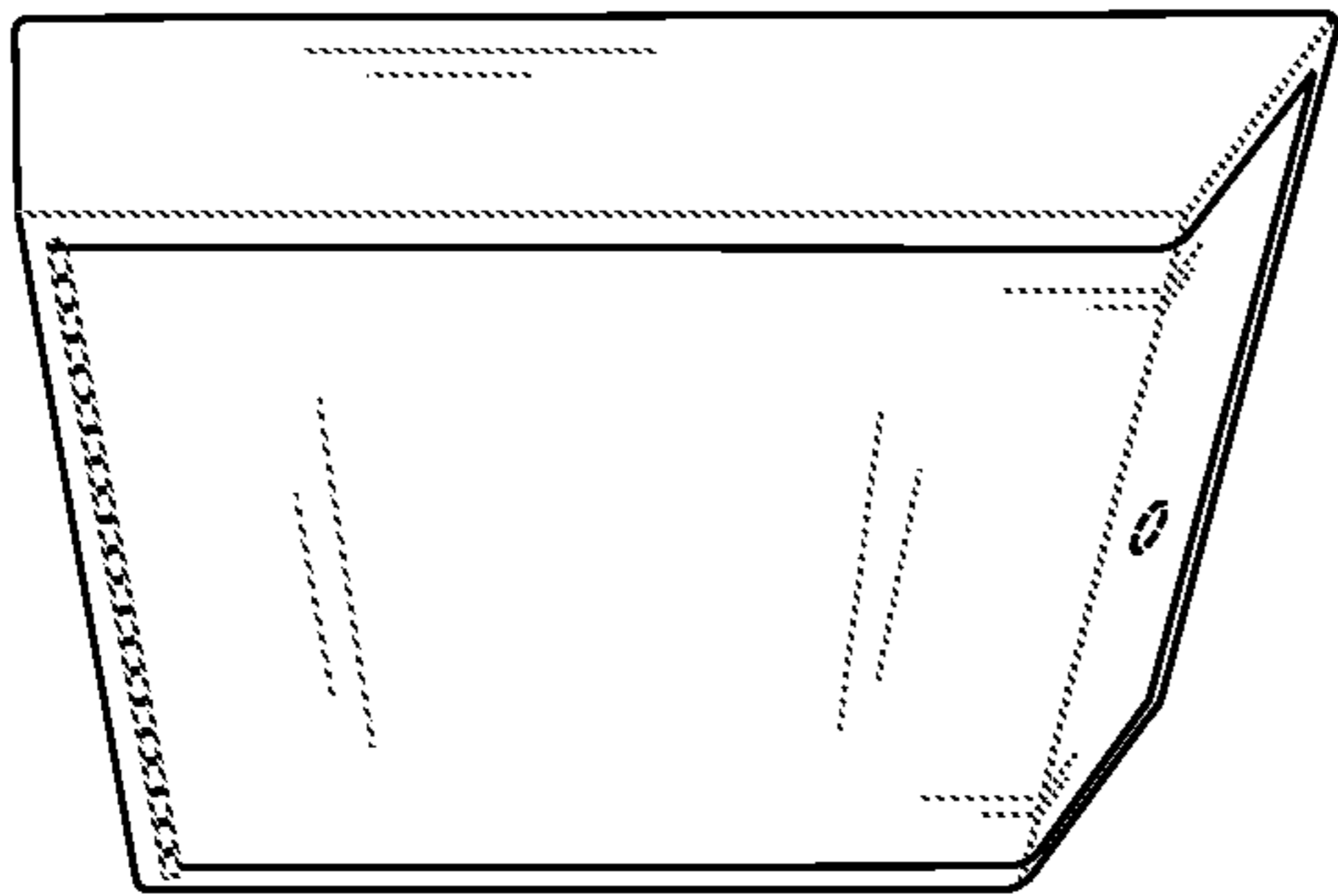

Fig. 6

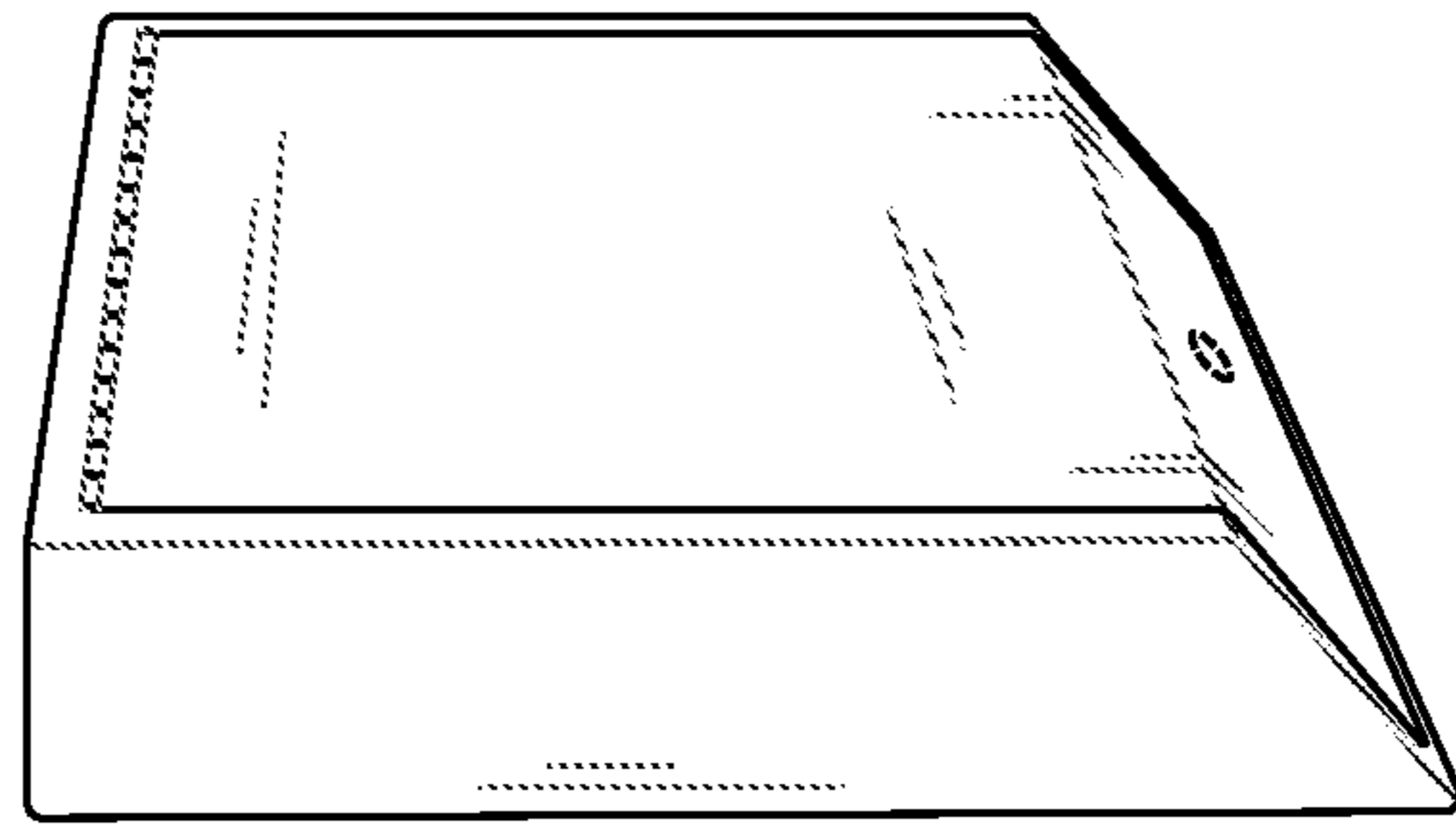

Fig. 7

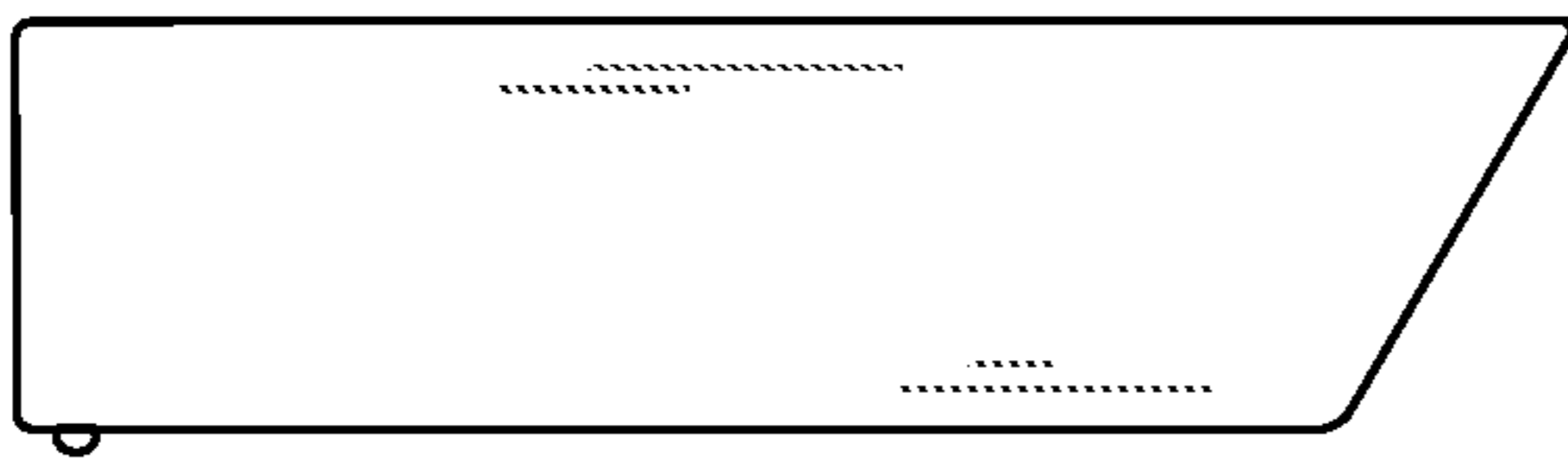

Fig. 8



Fig. 9

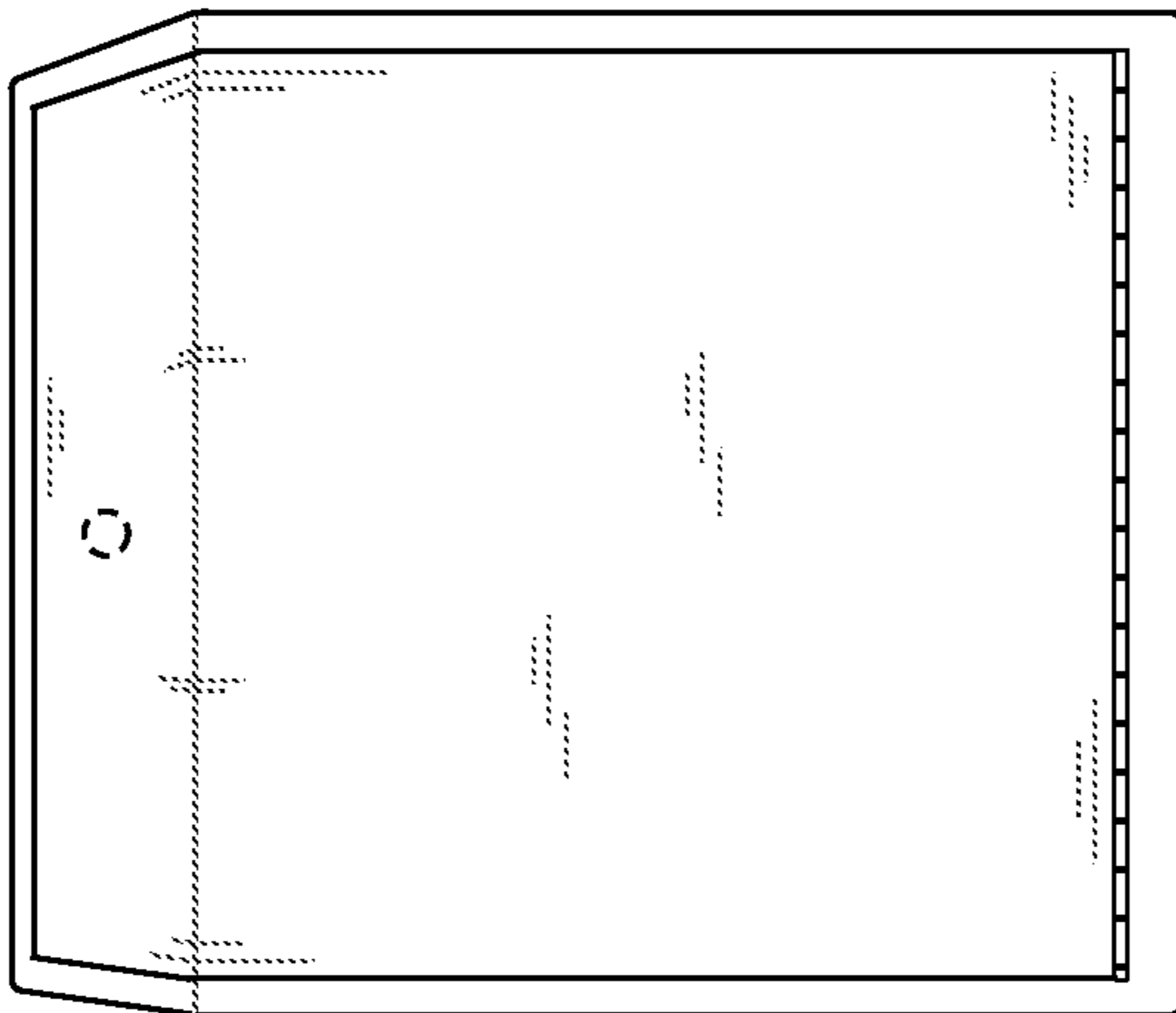

Fig. 10

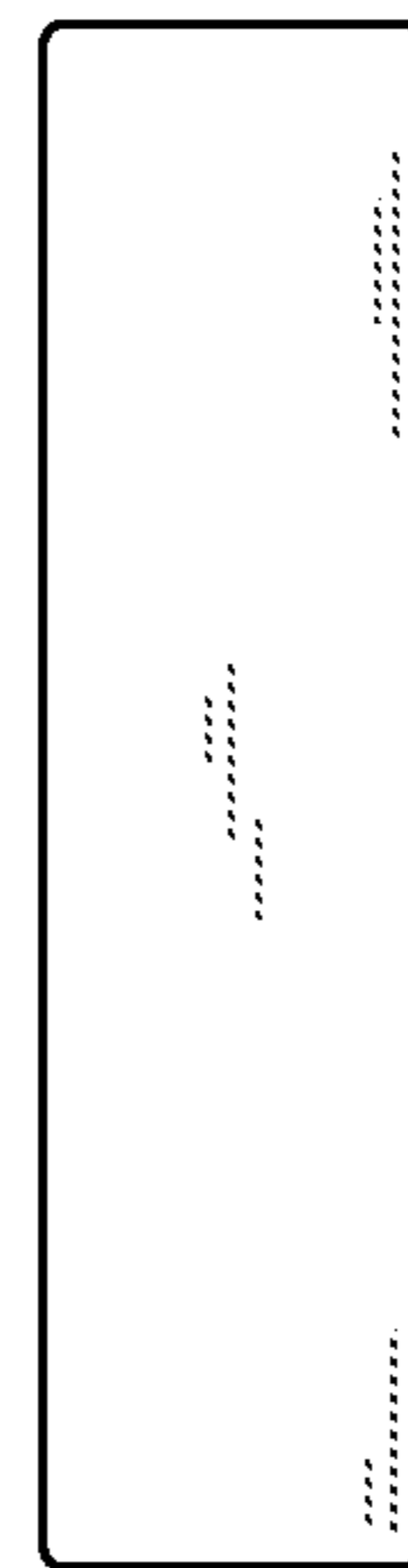

Fig. 11

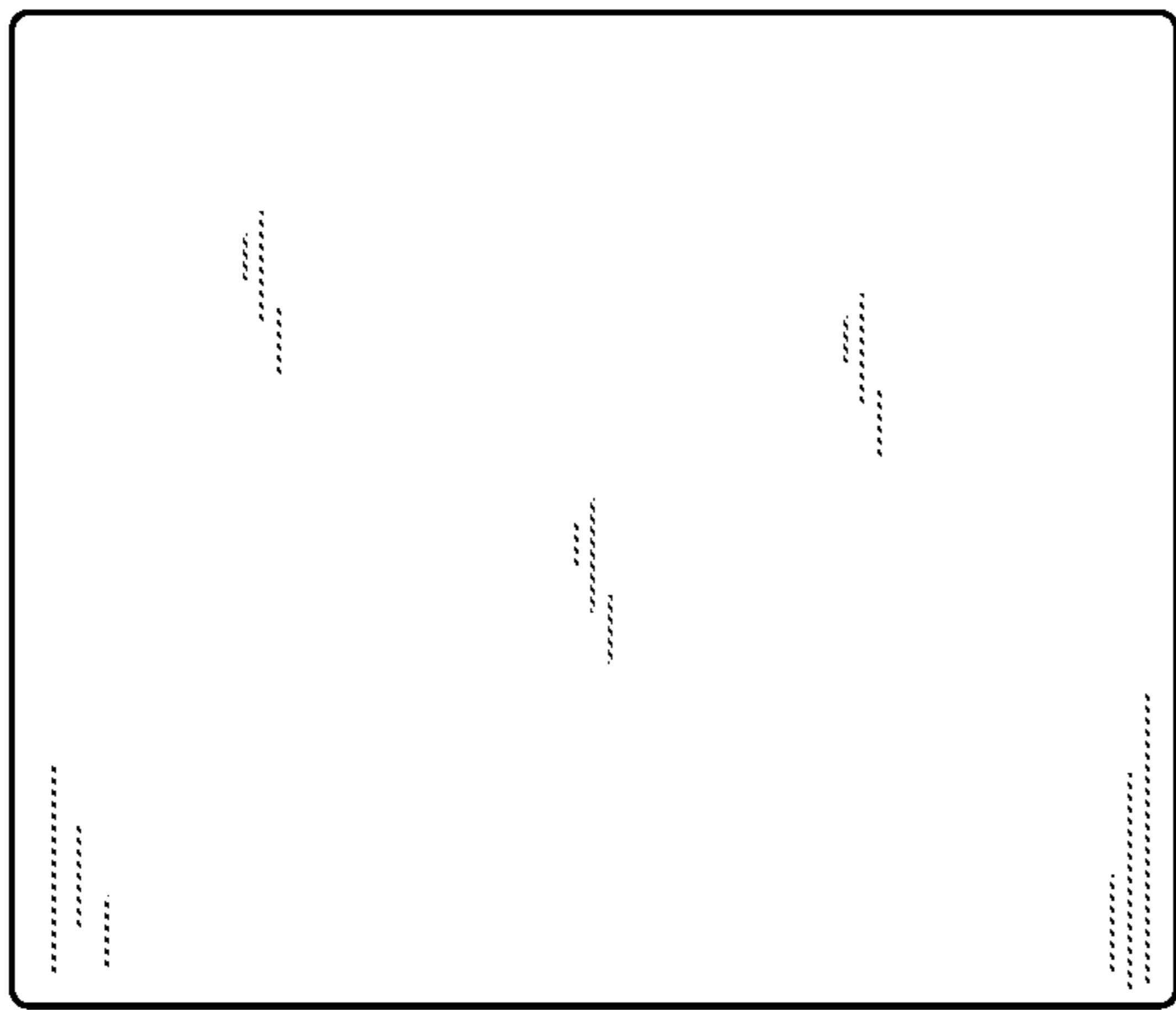

Fig. 12

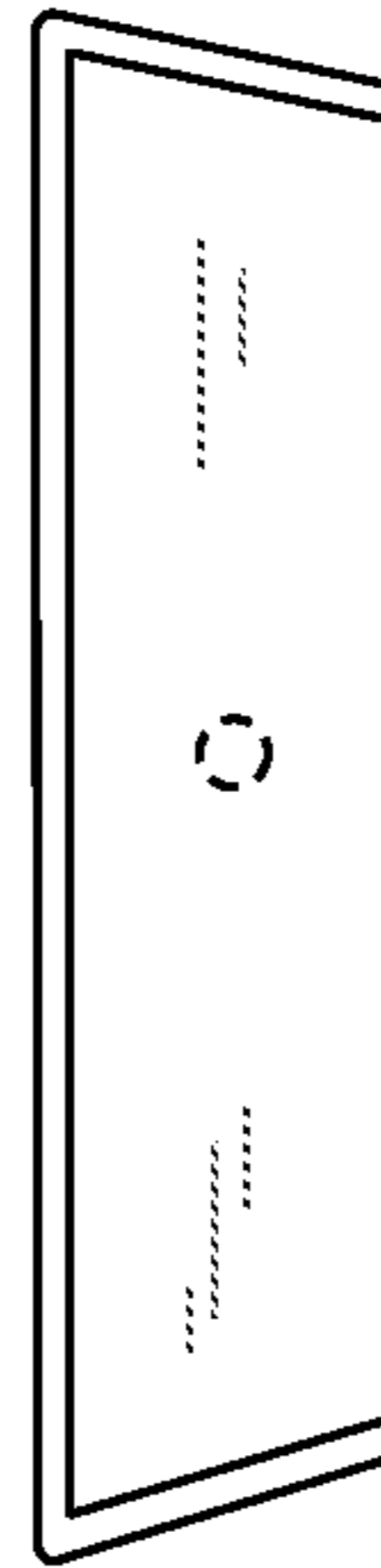

Fig. 13

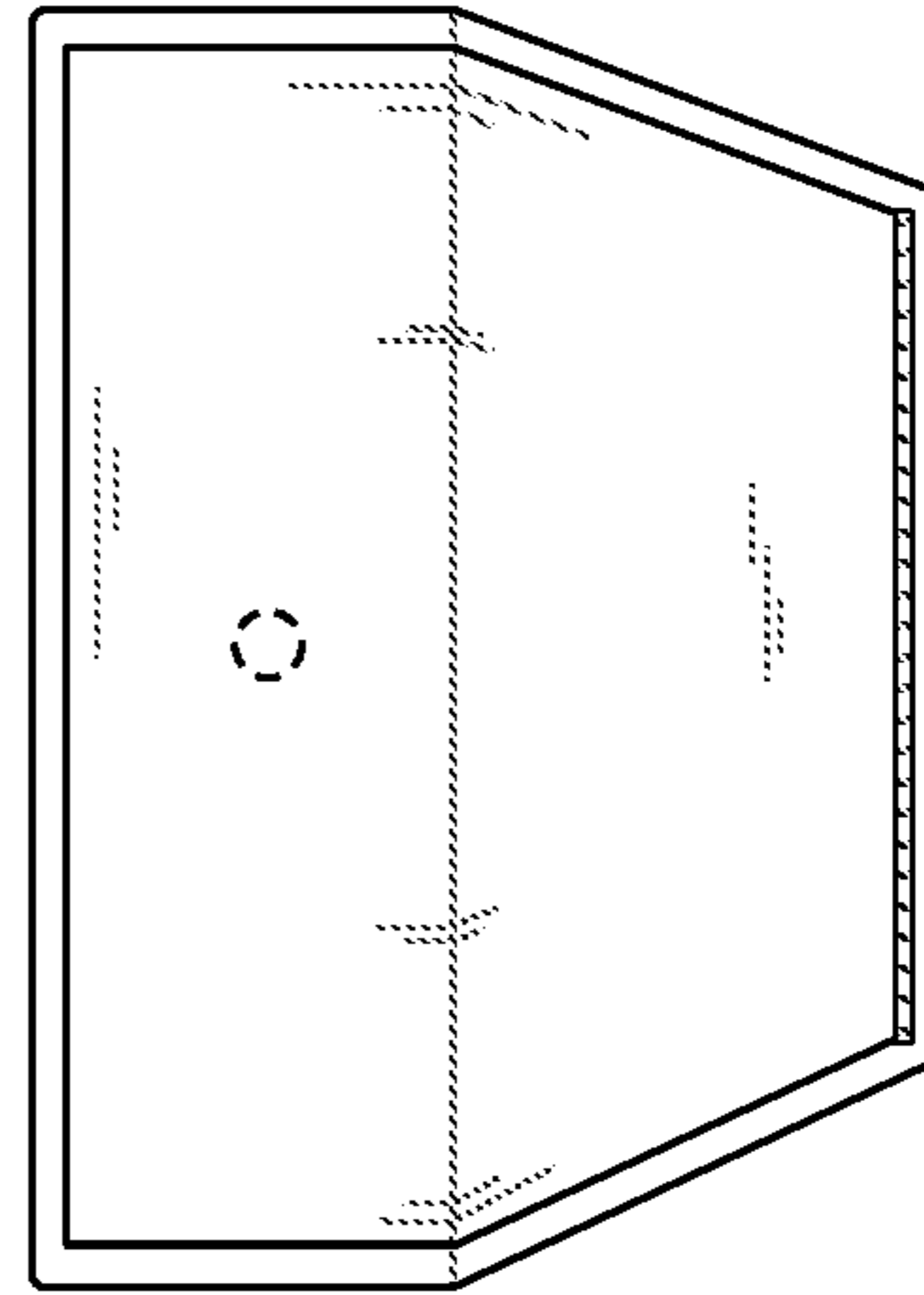

Fig. 14

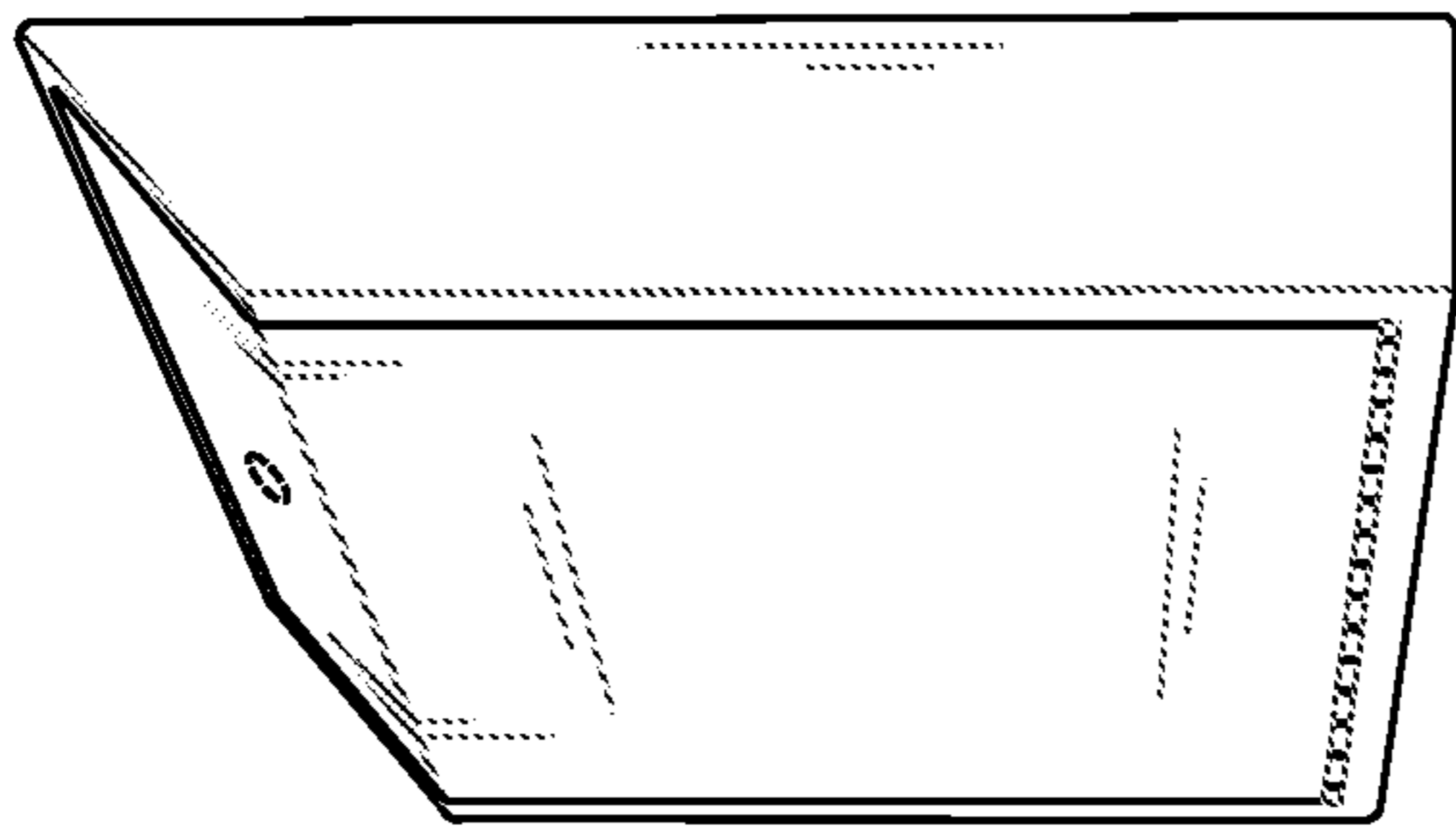

Fig. 15

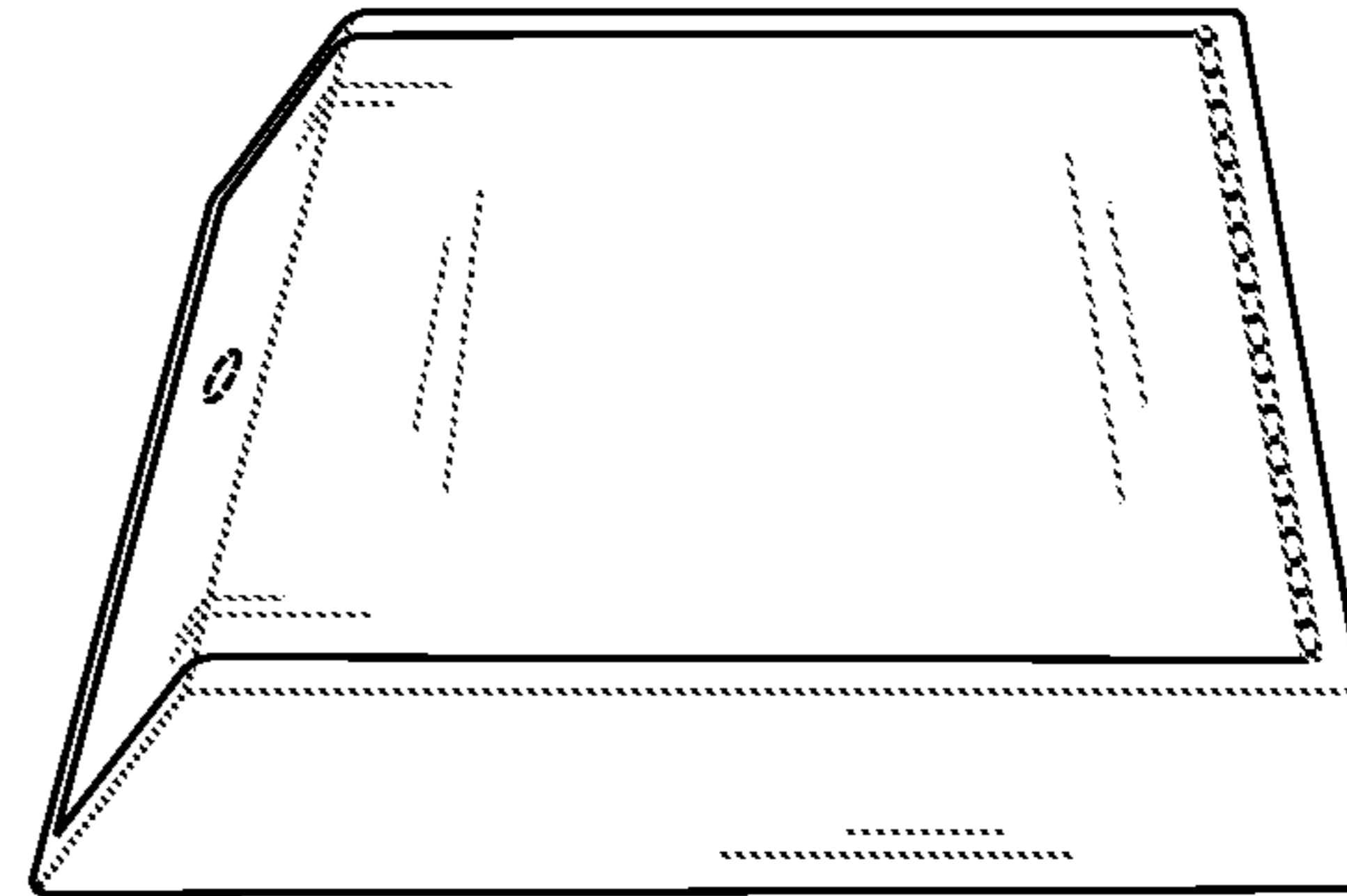

Fig. 16

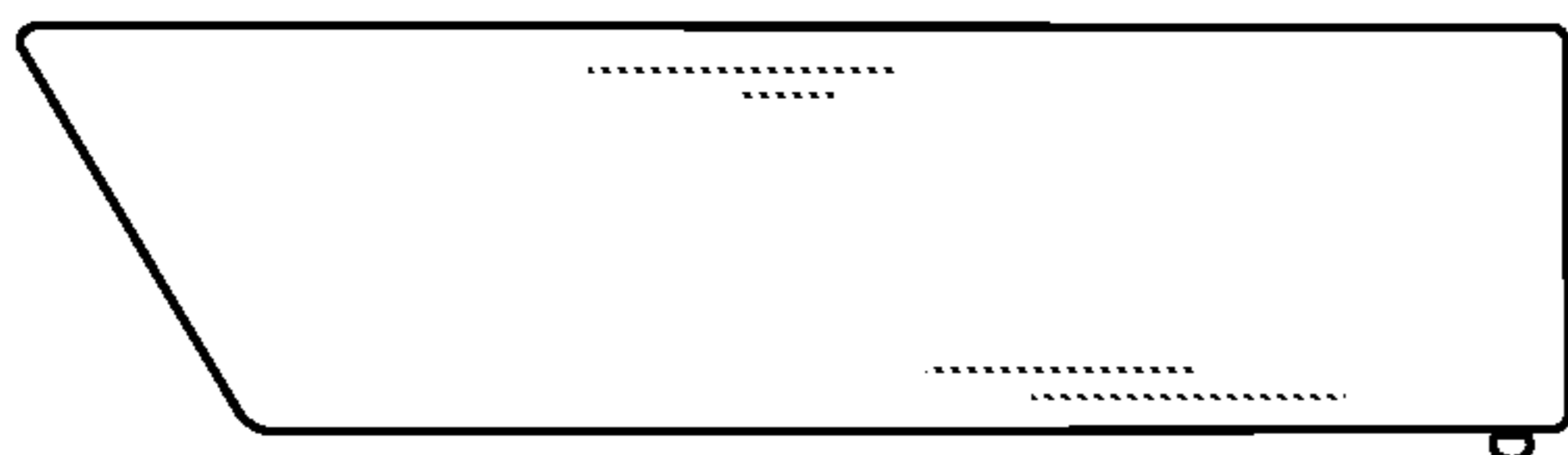

Fig. 17

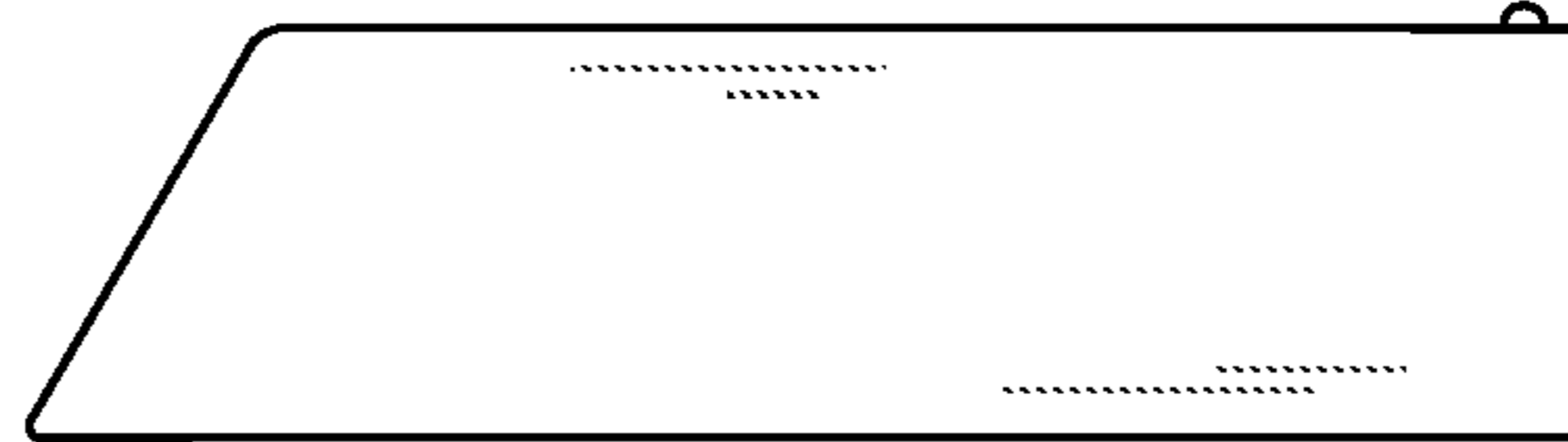

Fig. 18

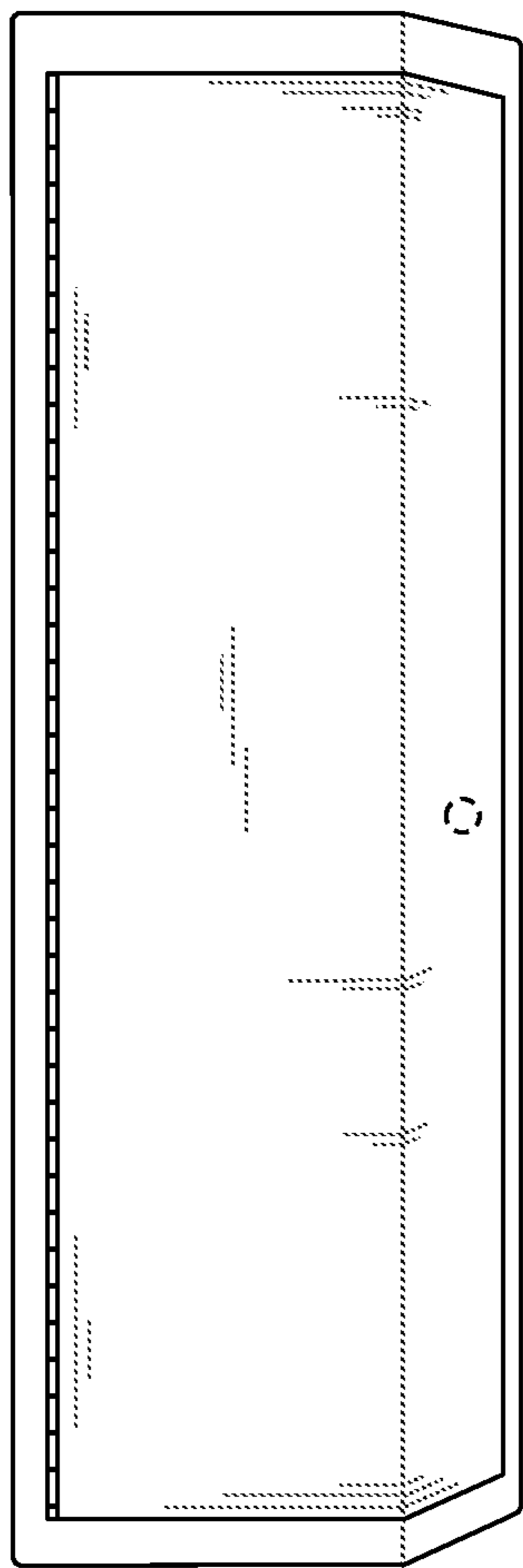

Fig. 19

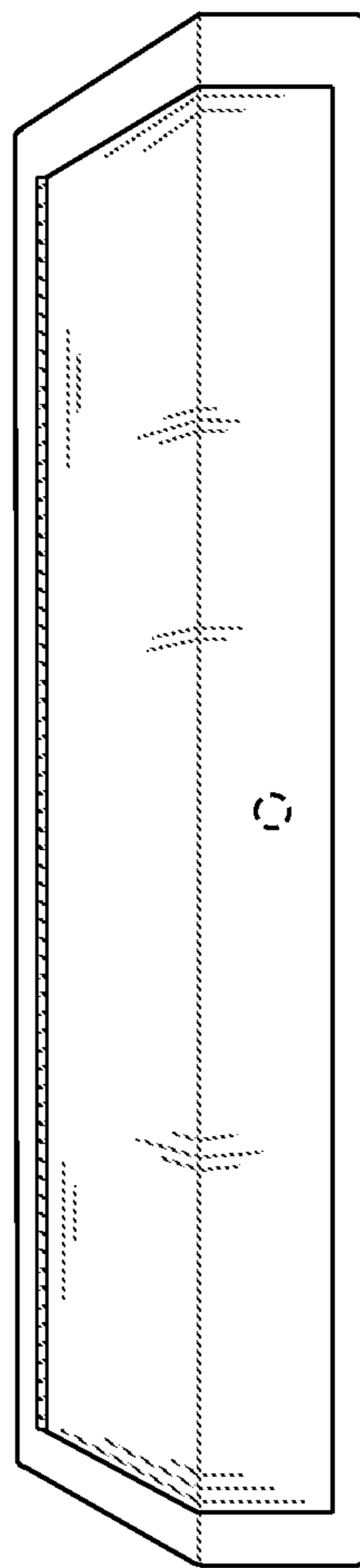

Fig. 20

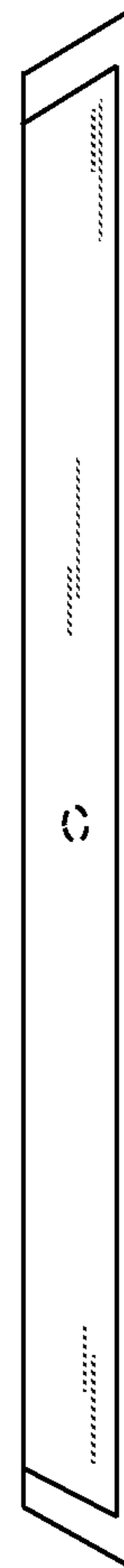

Fig. 21

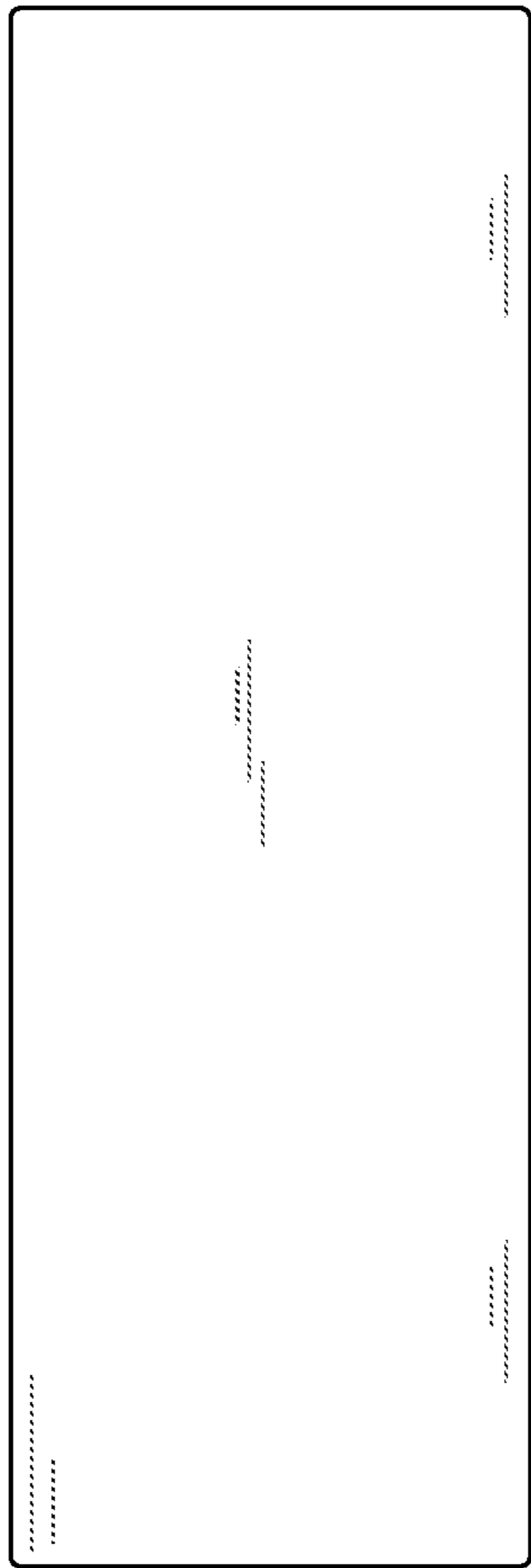

Fig. 22

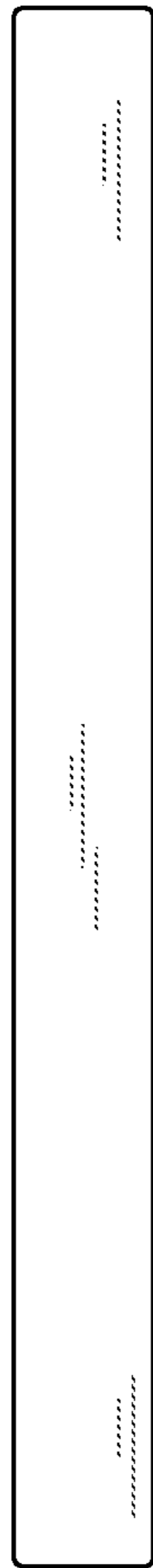

Fig. 23

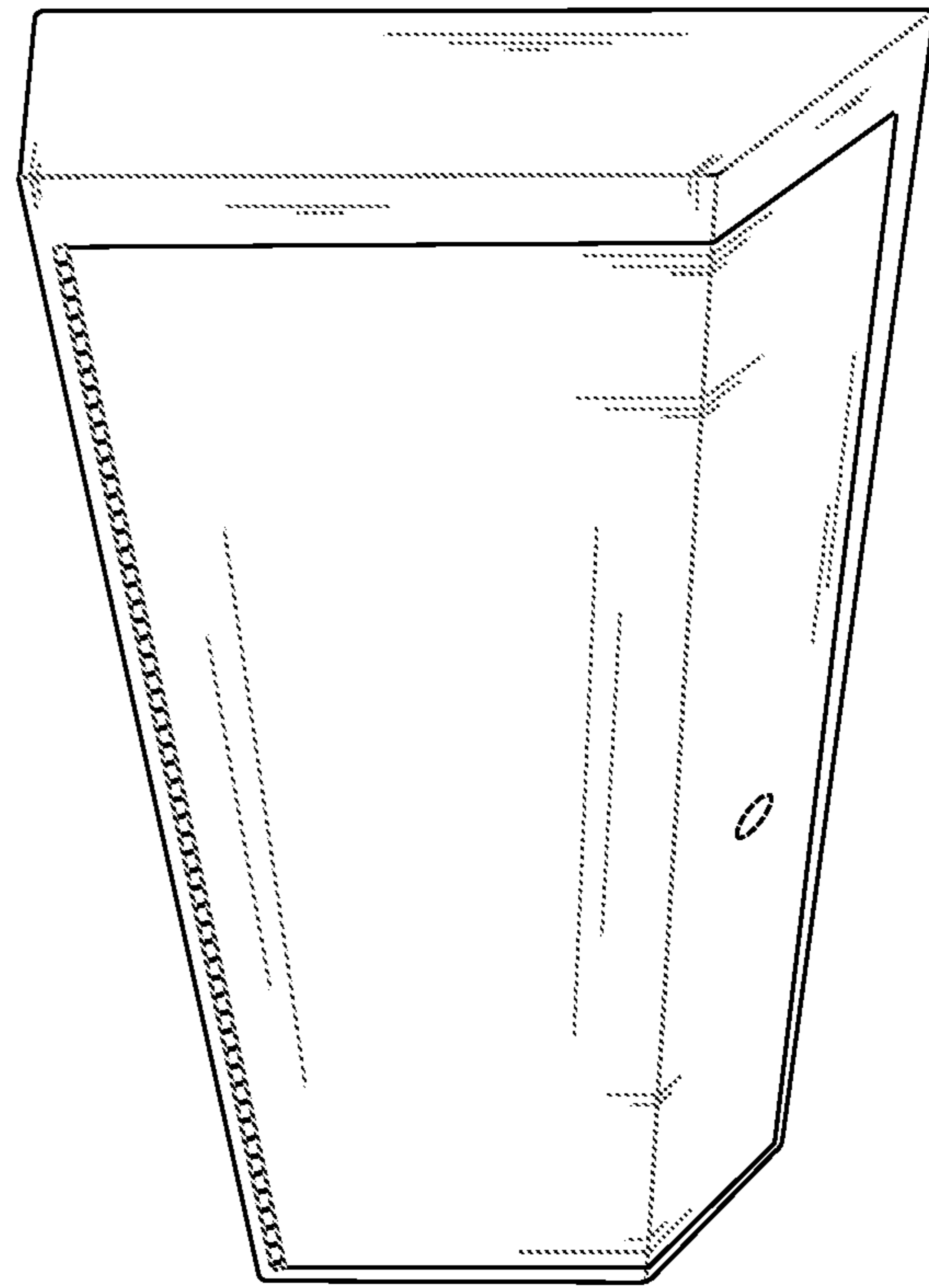

Fig. 24



Fig. 25

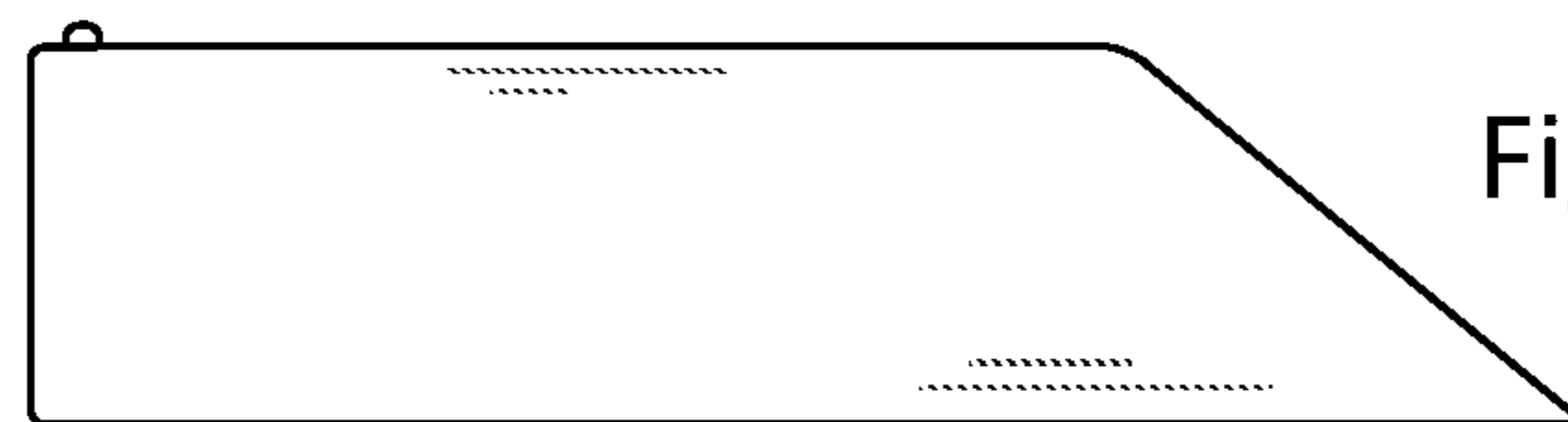

Fig. 26

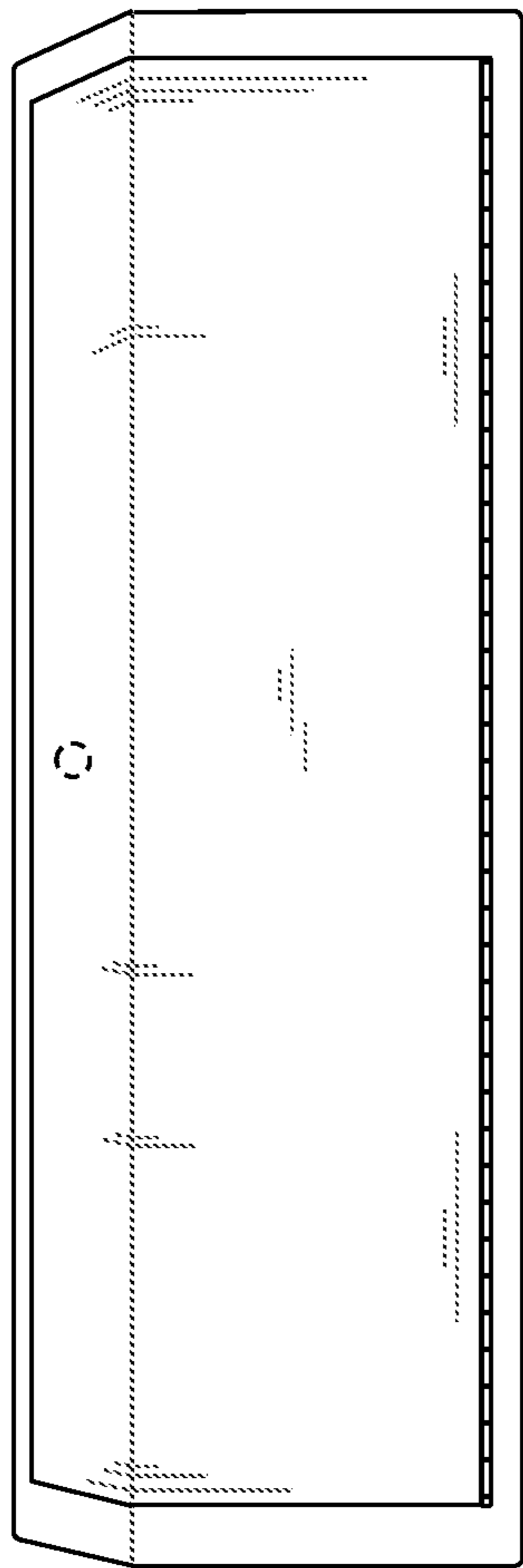

Fig. 27



Fig. 28

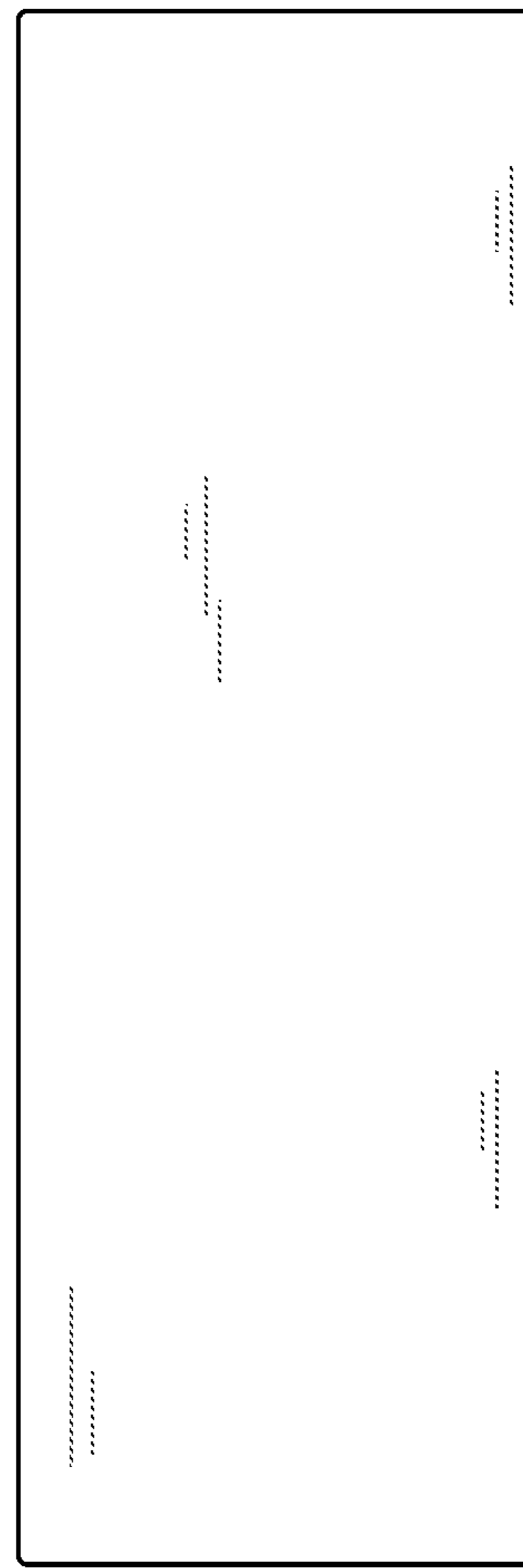

Fig. 29

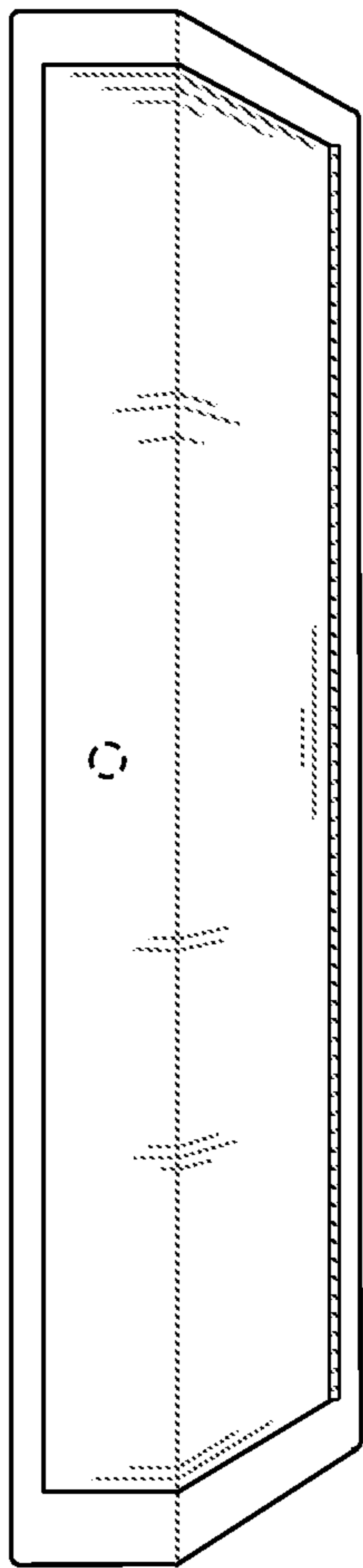

Fig. 30

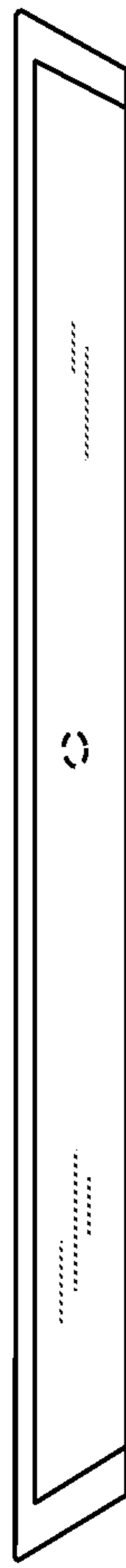

Fig. 31

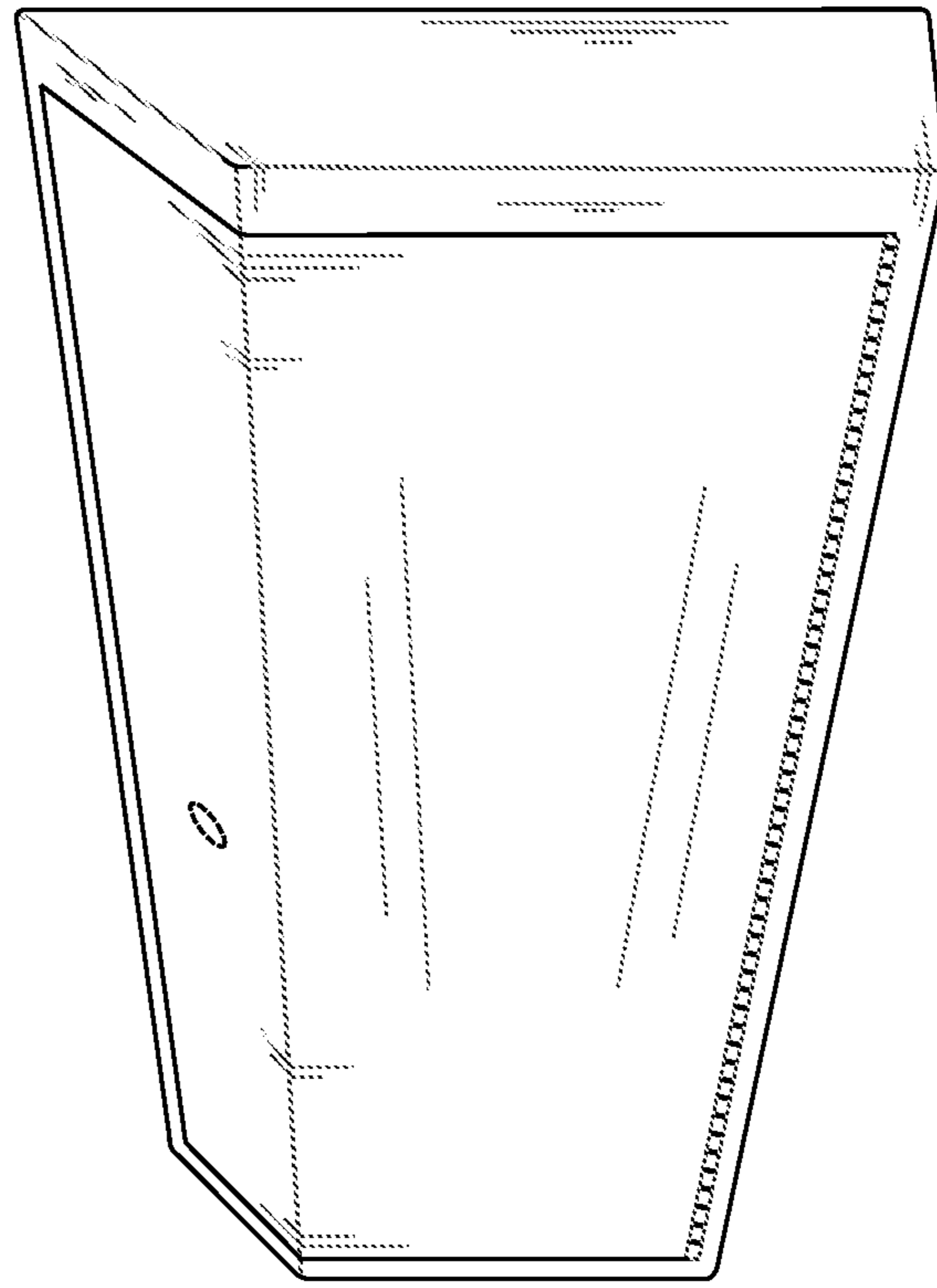

Fig. 32

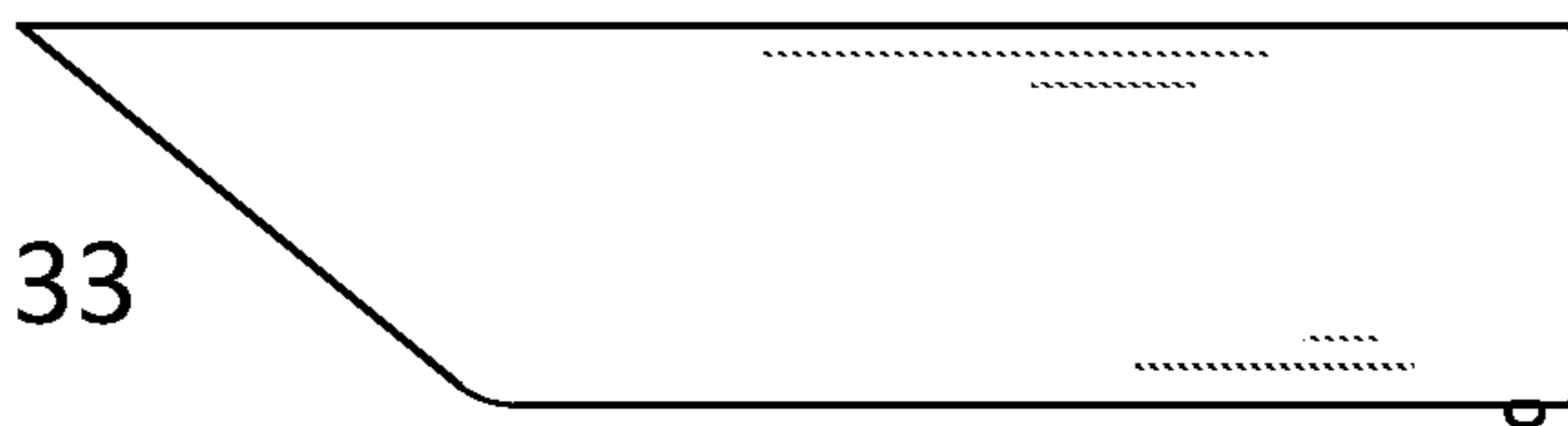

Fig. 33

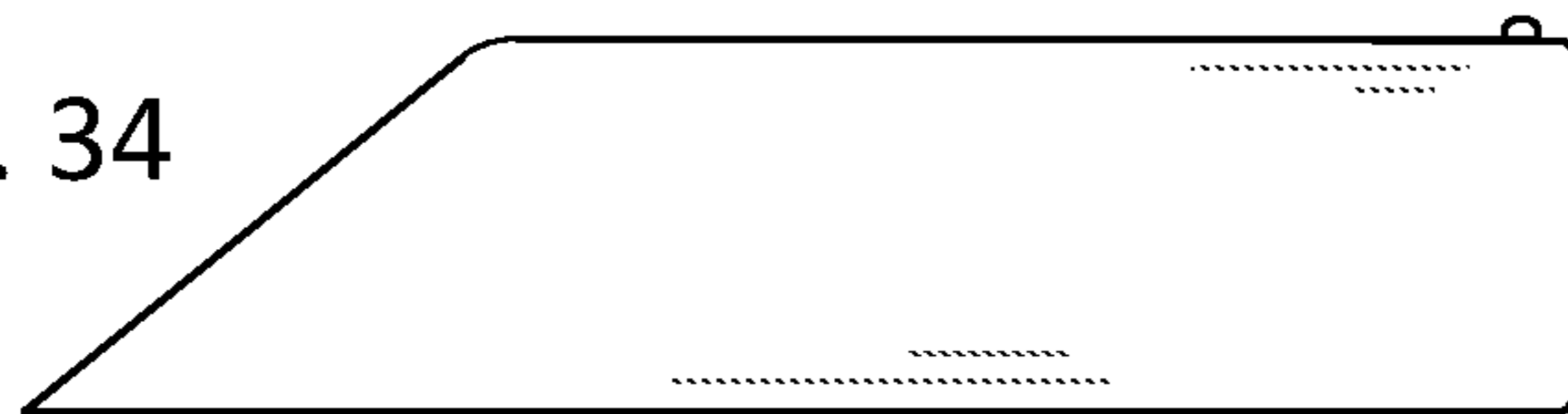

Fig. 34