

US00D895182S

(12) **United States Design Patent** (10) **Patent No.:** **US D895,182 S**  
**Liang et al.** (45) **Date of Patent:** **\*\* Sep. 1, 2020**

(54) **NIGHT LIGHT**

(71) Applicant: **Zhongshan Winstar Electrical Co., Ltd.**, Zhongshan, Guangdong (CN)

(72) Inventors: **Xiao Shan Liang**, Guangdong (CN); **Jie Chang Pan**, Guangdong (CN)

(73) Assignee: **Zhongshan Winstar Electrical Co., Ltd.**, Zhongshan (CN)

(\*\*) Term: **15 Years**

(21) Appl. No.: **29/684,555**

(22) Filed: **Mar. 22, 2019**

(30) **Foreign Application Priority Data**

Oct. 12, 2018 (CN) ..... 2018 3 0570701

(51) **LOC (12) Cl.** ..... **26-02**

(52) **U.S. Cl.**  
USPC ..... **D26/37; D26/26**

(58) **Field of Classification Search**  
USPC ..... D26/37-51, 63  
CPC ..... F21L 2003/00; F21L 4/00; F21L 4/005;  
F21L 4/02; F21L 4/025; F21L 4/027;  
F21L 4/04; F21L 4/08; F21L 2005/00;  
F21L 7/00; F21L 11/00; F21L 13/00;  
F21L 13/04; F21L 13/08; F21L 14/02;  
F21L 17/00; F21L 19/00; F21L 25/00  
See application file for complete search history.

(56) **References Cited**

**U.S. PATENT DOCUMENTS**

- D602,186 S \* 10/2009 Lee ..... D26/37
- D668,382 S \* 10/2012 Schieffelin ..... D26/142
- D682,451 S \* 5/2013 Hardy ..... D26/60
- D731,687 S \* 6/2015 Haws ..... D26/46
- D732,215 S \* 6/2015 Su ..... D26/37

- D743,594 S \* 11/2015 Scazziga ..... D26/37
- D756,014 S \* 5/2016 Bao ..... D26/65
- D764,087 S \* 8/2016 Workman ..... D26/37
- D766,477 S \* 9/2016 Ma ..... D26/37
- D779,092 S \* 2/2017 Xu ..... D26/37
- D787,728 S \* 5/2017 Wing ..... D26/37
- D805,666 S \* 12/2017 Nguyen ..... D26/37
- D819,244 S \* 5/2018 Wojan ..... D26/37
- D828,938 S \* 9/2018 Hou ..... D26/38
- D829,354 S \* 9/2018 Cacciabeve ..... D26/37
- D831,248 S \* 10/2018 Kuhls ..... D26/37
- D844,873 S \* 4/2019 Koshiba ..... D26/46
- D855,227 S \* 7/2019 Becker ..... D26/37
- D875,978 S \* 2/2020 Willows ..... D26/39
- D875,979 S \* 2/2020 Levy ..... D26/39
- D877,947 S \* 3/2020 Lei ..... 26/37
- D878,648 S \* 3/2020 Zhao ..... D26/37

\* cited by examiner

*Primary Examiner* — Lakiya G Rogers  
*Assistant Examiner* — Carissa C Fitts

(57) **CLAIM**

The ornamental design for a night light, as shown and described.

**DESCRIPTION**

FIG. 1 is a front elevational view of a night light showing our new design;  
FIG. 2 is a rear elevational view thereof;  
FIG. 3 is a top plan view thereof;  
FIG. 4 is a bottom plan view thereof;  
FIG. 5 is a left side view thereof;  
FIG. 6 is a right side view thereof;  
FIG. 7 is a bottom, front and left side perspective view thereof; and,  
FIG. 8 is a top, rear and right side perspective view showing the night light in a use state.  
The broken lines in the drawings illustrate portions of the night light which form no part of the claimed design.

**1 Claim, 8 Drawing Sheets**

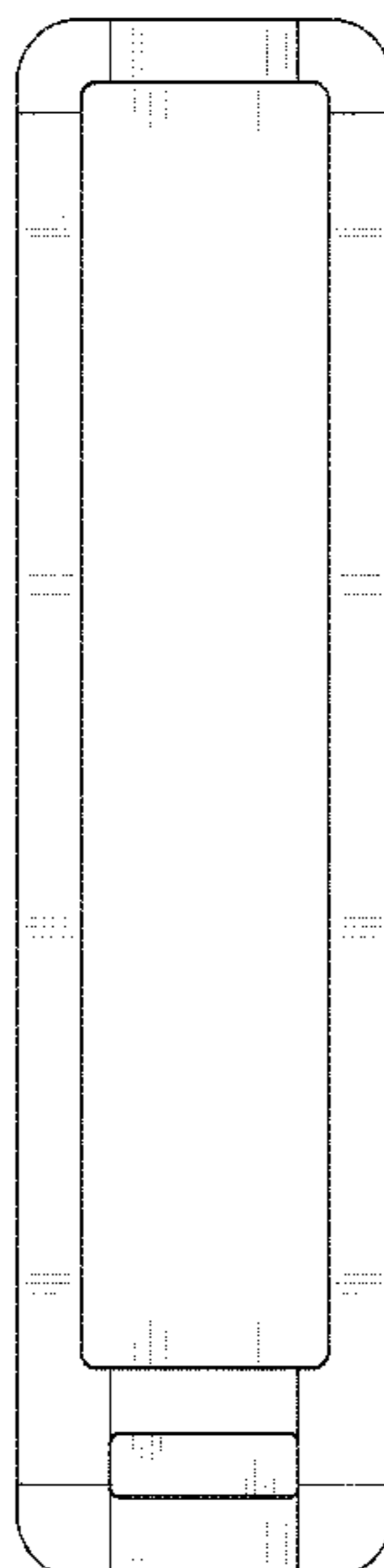

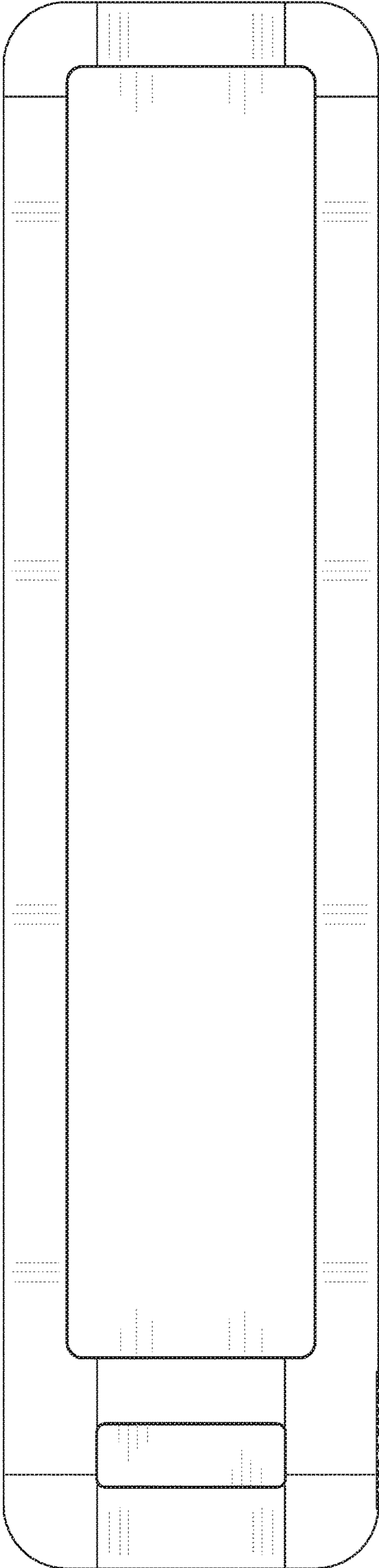

Fig.1

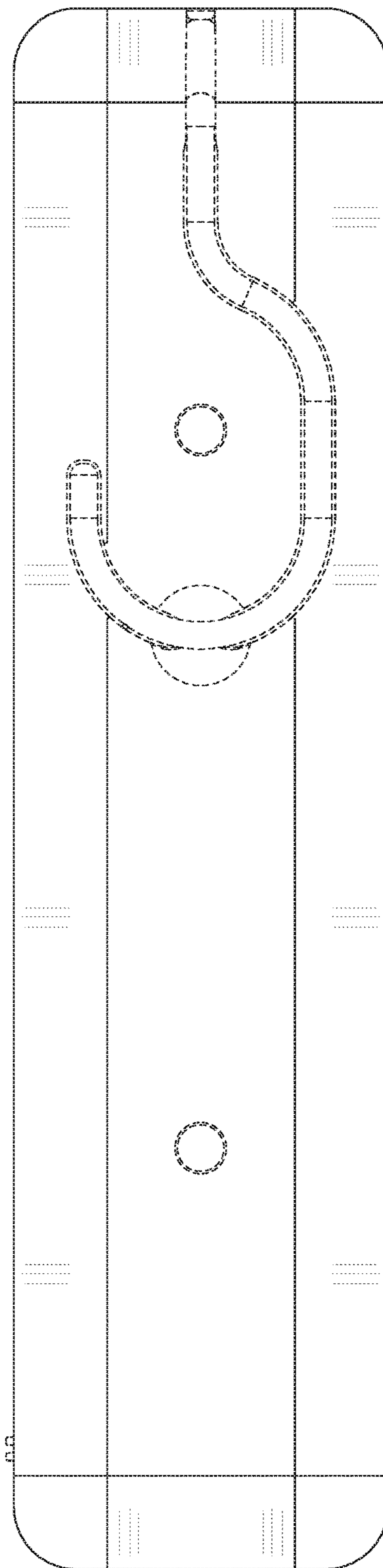

Fig.2

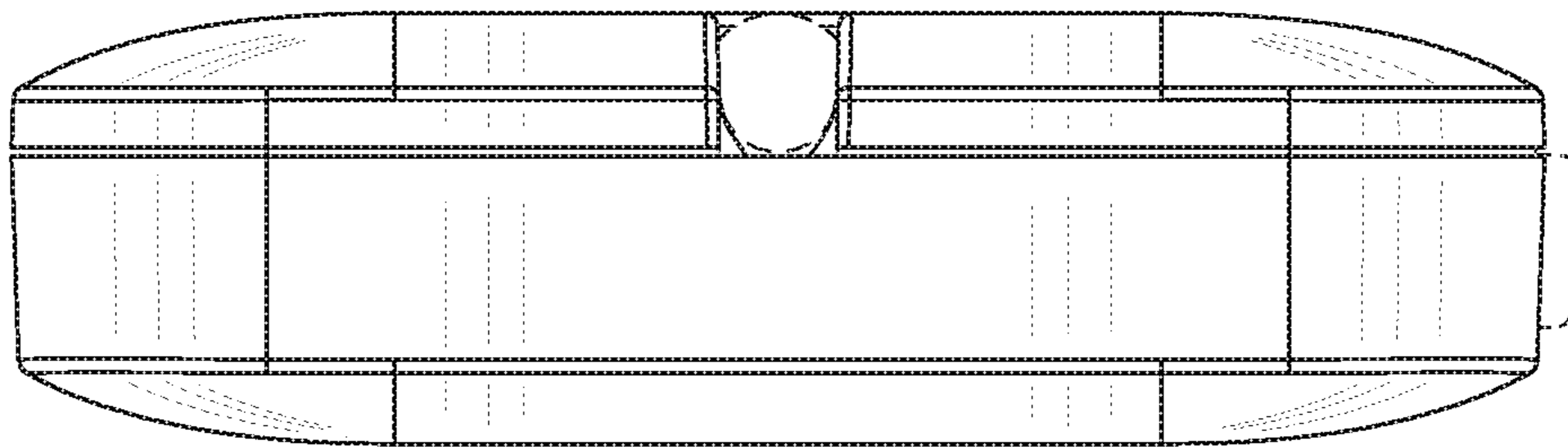

Fig.3

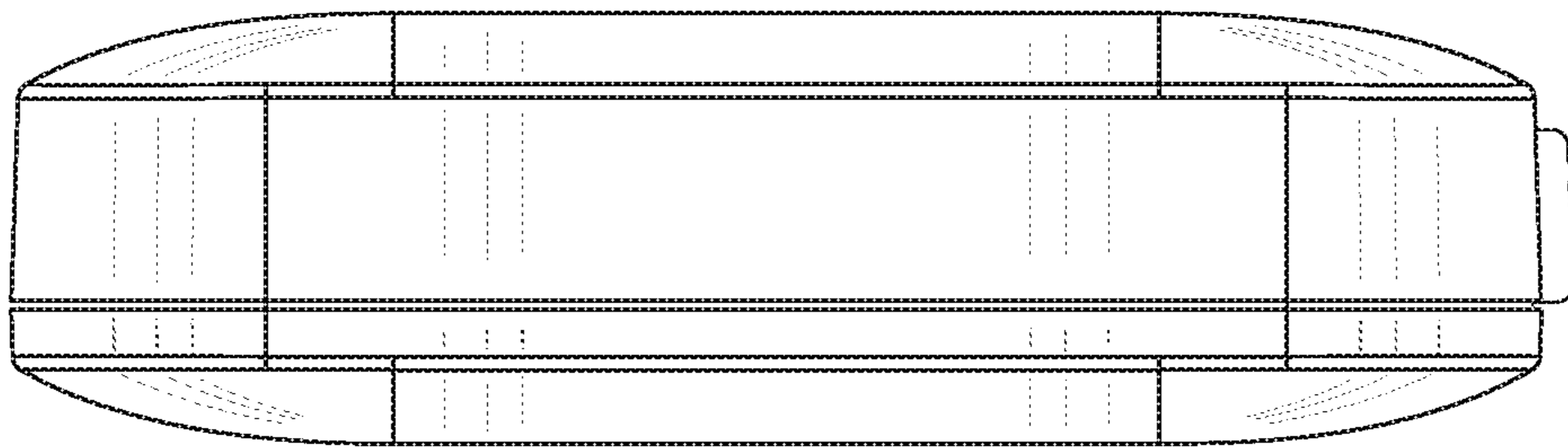

Fig.4

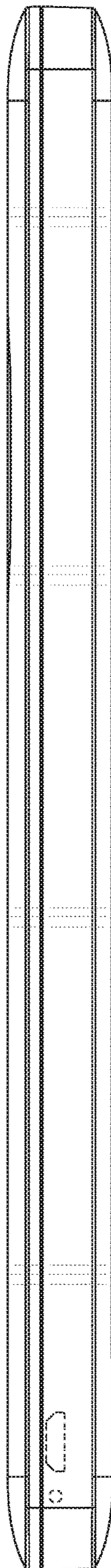

Fig.5



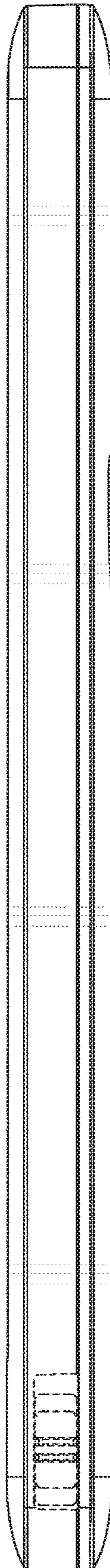

Fig.6

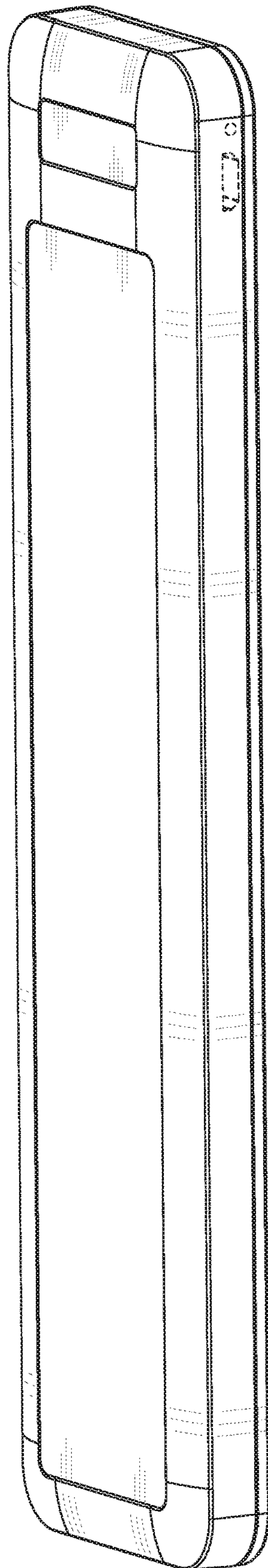

Fig.7



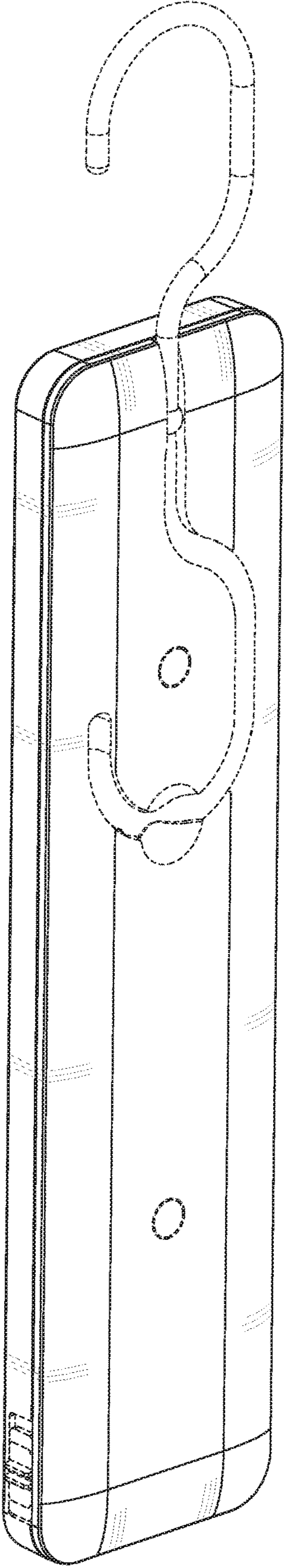

Fig.8