



US00D895176S

(12) **United States Design Patent** (10) **Patent No.:** **US D895,176 S**
Broom (45) **Date of Patent:** **** Sep. 1, 2020**

(54) **LIGHTING FIXTURE**
(71) Applicant: **Lee Broom Limited**, London (GB)
(72) Inventor: **Lee Broom**, London (GB)
(**) Term: **15 Years**

D774,667 S * 12/2016 Zhang D26/3
D810,987 S * 2/2018 Pan D26/88
D810,988 S * 2/2018 Pan D26/88
D826,451 S * 8/2018 Sonneman D26/80
D826,452 S * 8/2018 Sonneman D26/80
D826,453 S * 8/2018 Sonneman D26/80

(21) Appl. No.: **35/507,177**
(22) Filed: **Jan. 21, 2019**

OTHER PUBLICATIONS

Screenshot: Orion Globe Light Polished Gunmetal. Undated; one page. Found online Apr. 30, 2020 at <http://www.leebroom.com/lighting/orion-globe-light-polished-gunmetal/#image-3> (Year: 2020).*
Lee Broom Orion Globe Light Spec/Tear Sheet. Dated 2018; one page. Found online Apr. 30, 2020 at <http://www.leebroom.com/assets/Uploads/Orion-Globe-Light9.pdf> (Year: 2018).*

(80) **Hague Agreement Data**
Int. Filing Date: **Jan. 21, 2019**
Int. Reg. No.: **DM/200477**
Int. Reg. Date: **Jan. 21, 2019**
Int. Reg. Pub. Date: **Aug. 2, 2019**

* cited by examiner

Primary Examiner — Robert M. Spear

(51) **LOC (12) Cl.** **26-03**
(52) **U.S. Cl.**
USPC **D26/24**

(57) **CLAIM**

The ornamental design for lighting fixture, as shown and described.

(58) **Field of Classification Search**
USPC D26/1, 2, 3, 24, 70, 72, 75, 78, 79, 80, D26/81, 82, 84, 85, 86, 88, 90, 91, 102, D26/110, 122, 128, 129, 130, 137
CPC .. G03B 2215/0589; F21S 2/005; F21S 4/002; F21S 4/008; F21S 8/031; F21S 8/038; F21S 8/04; F21S 8/043; F21S 8/046; F21S 8/06; F21S 8/061; F21S 8/063; F21S 8/065; F21S 8/066; F21S 8/068
See application file for complete search history.

DESCRIPTION

- 1.-2. Lighting fixture
- 1.1 : Perspective
- 1.2 : Perspective
- 1.3 : Front
- 1.4 : Back
- 1.5 : Right
- 1.6 : Left
- 1.7 : Bottom
- 1.8 : Top
- 2.1 : Perspective
- 2.2 : Front
- 2.3 : Back
- 2.4 : Right
- 2.5 : Left
- 2.6 : Bottom
- 2.7 : Top

(56) **References Cited**
U.S. PATENT DOCUMENTS

D40,219 S * 8/1909 Pitner D26/72
D40,220 S * 8/1909 Pitner D26/72
D51,392 S * 10/1917 Pelletier D26/72
D225,163 S * 11/1972 Waddell D26/2
D619,291 S * 7/2010 Thevenot D26/75
D629,925 S * 12/2010 Ashida D26/2
D725,306 S * 3/2015 Salvagno D26/84
D730,559 S * 5/2015 Castelli D26/80

1 Claim, 15 Drawing Sheets

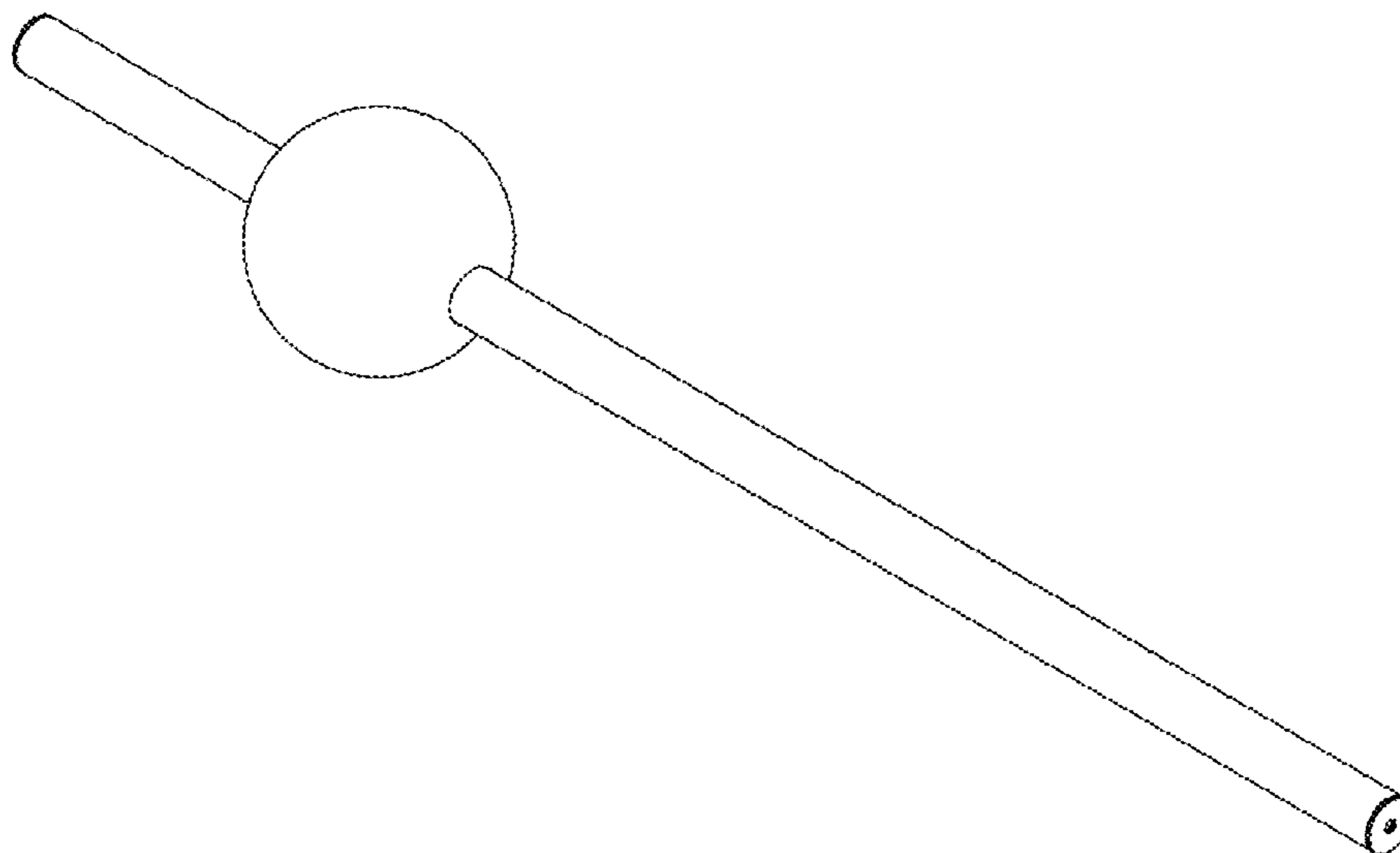

1.1

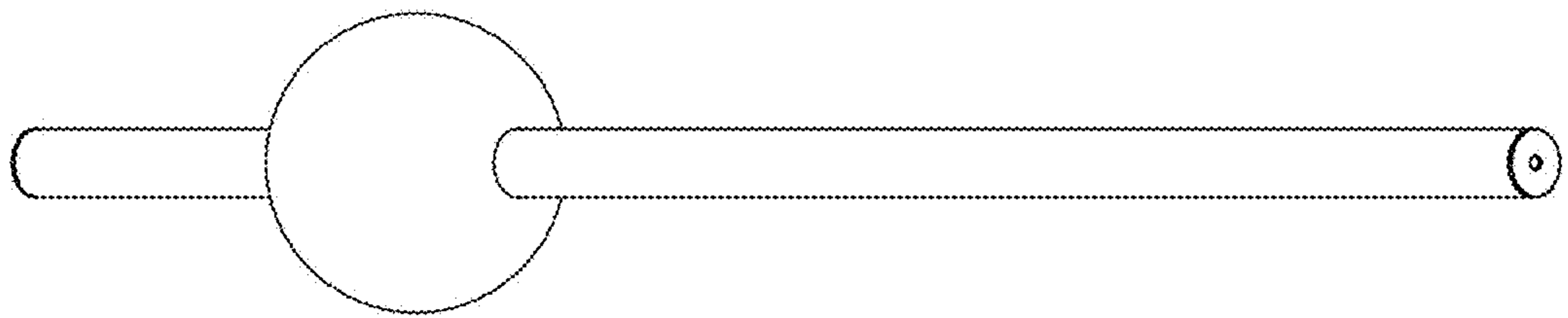

1.2

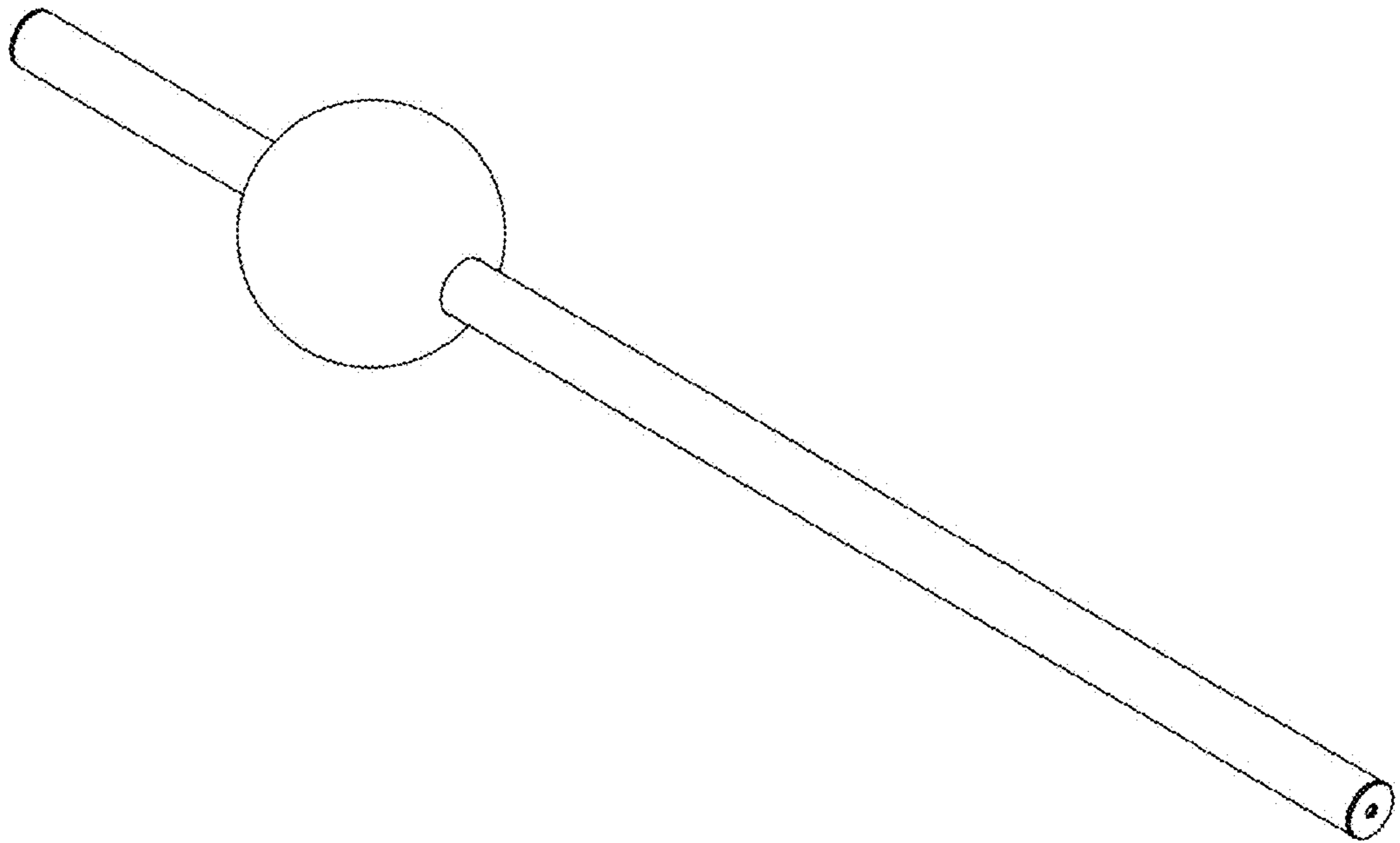

1.3

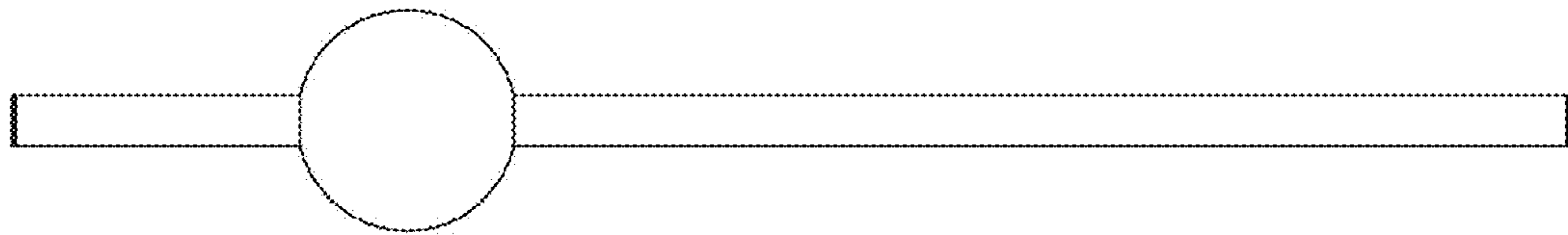

1.4

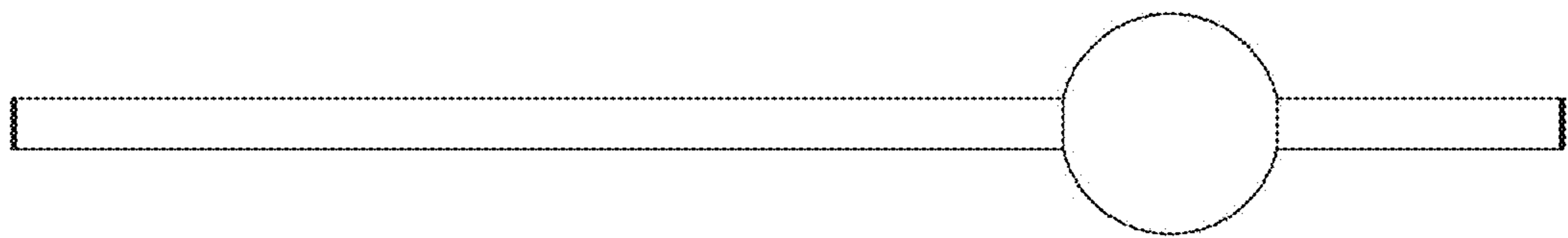

1.5

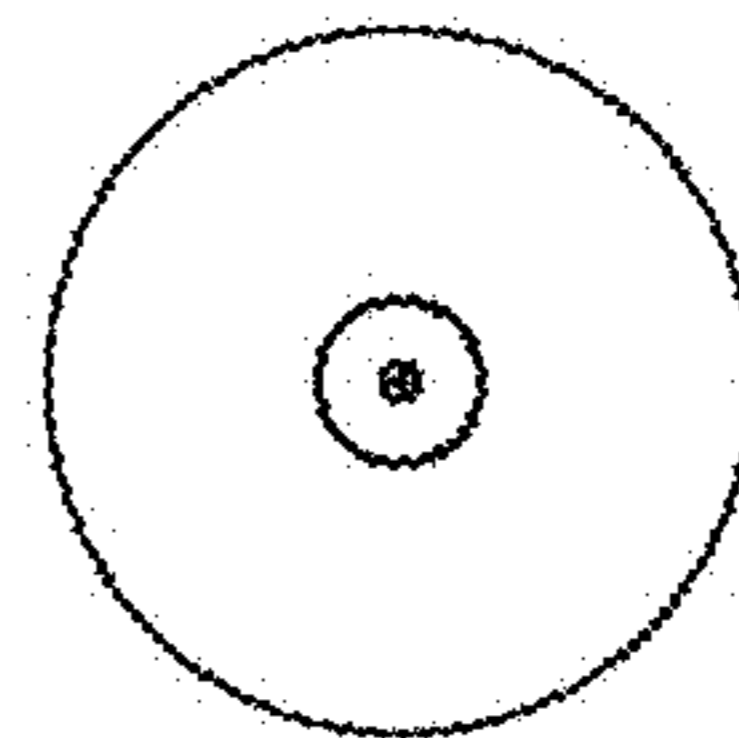

1.6

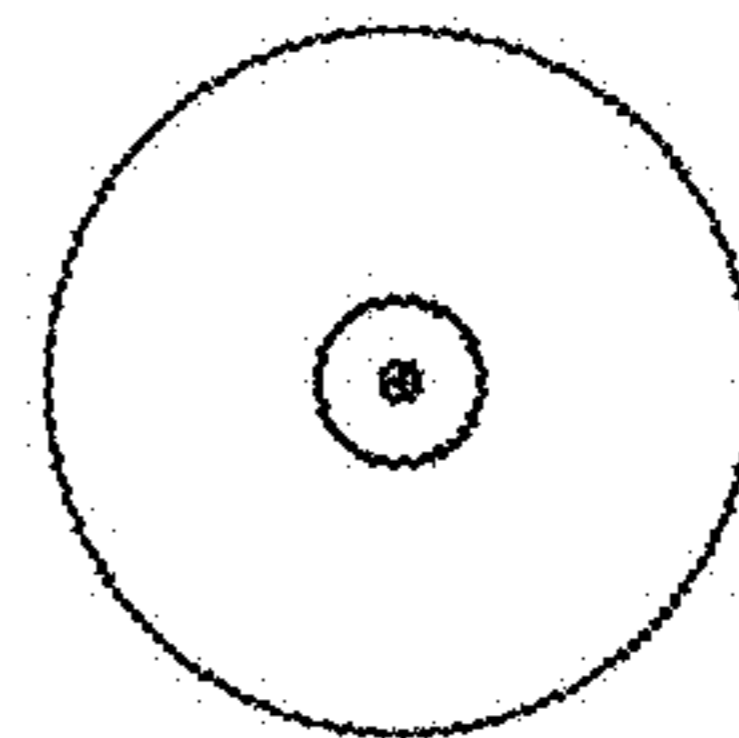

1.7

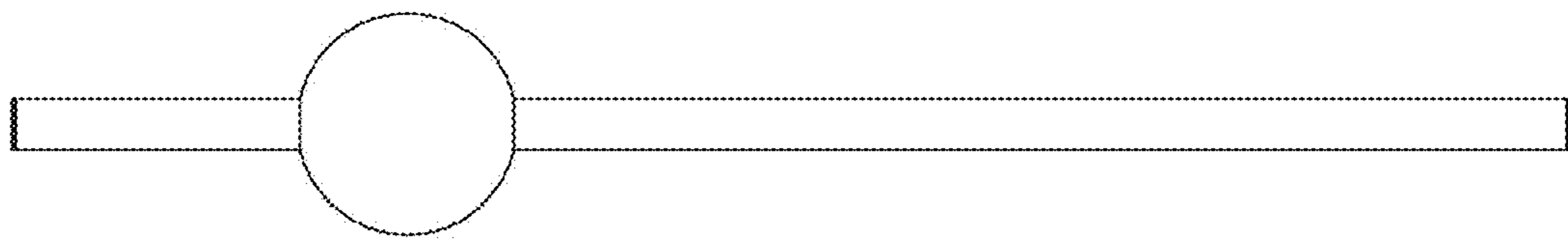

1.8

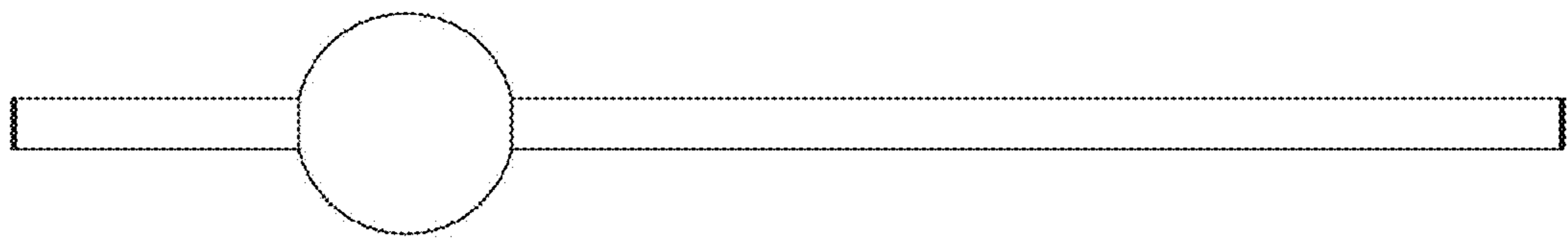

2.1

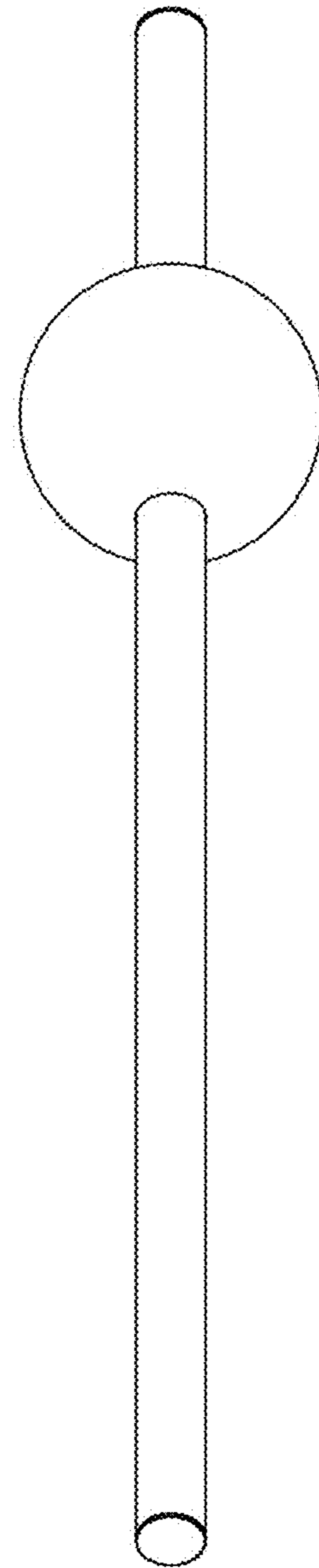

2.2

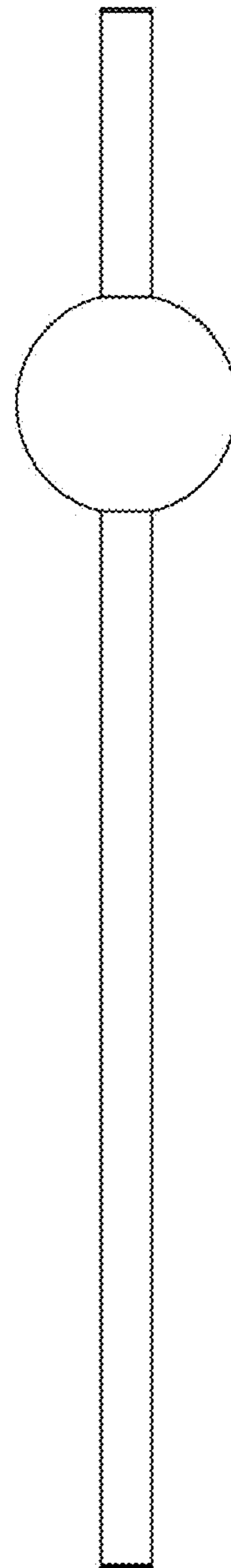

2.3

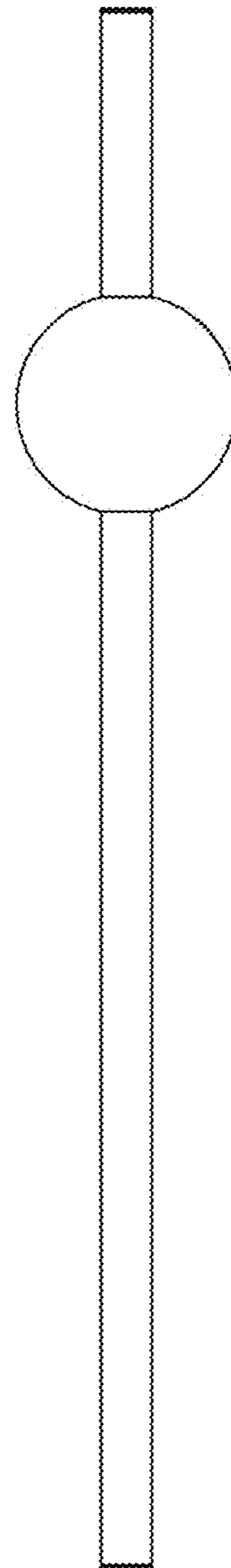

2.4

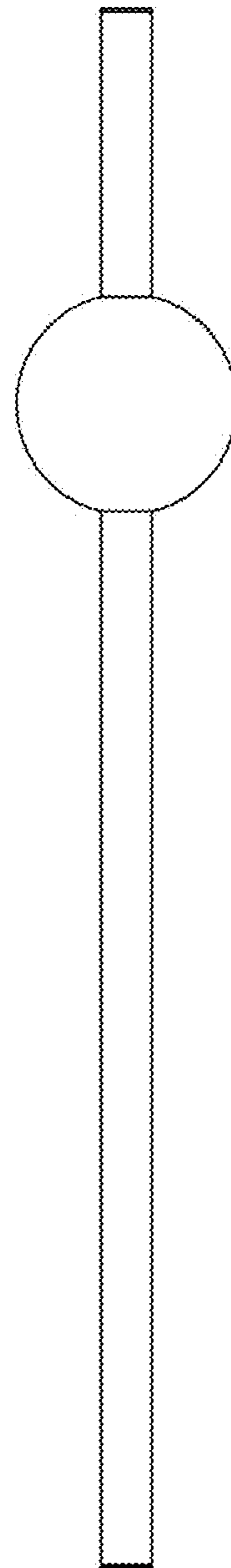

2.5

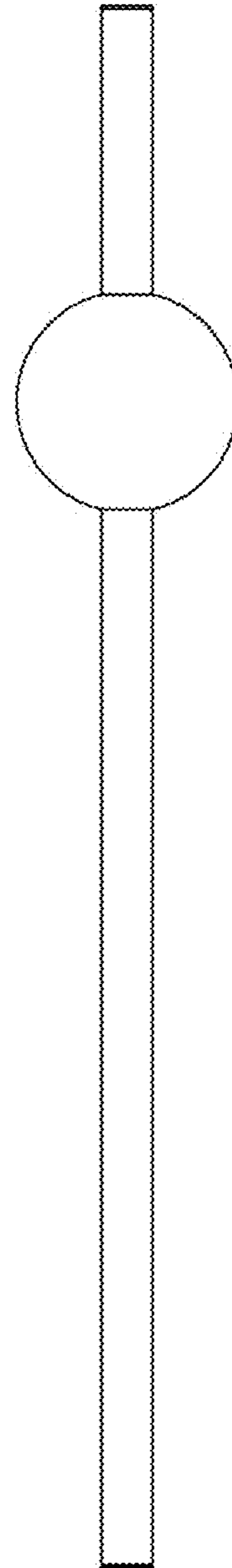

2.6

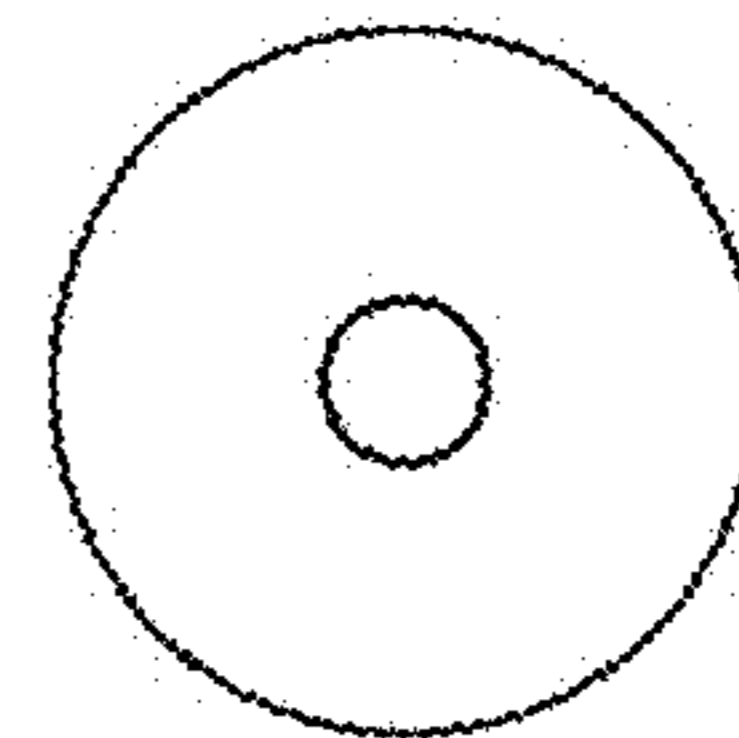

2.7

