



US00D895080S

(12) **United States Design Patent** (10) **Patent No.:** **US D895,080 S**
Moir (45) **Date of Patent:** **** Sep. 1, 2020**

(54) **BATHTUB**
 (71) Applicant: **Jacuzzi Inc.**, Chino Hills, CA (US)
 (72) Inventor: **Erica A. Moir**, Santa Ana, CA (US)
 (73) Assignee: **Jacuzzi Inc.**, Chino Hills, CA (US)
 (**) Term: **15 Years**

D745,644 S 12/2015 Burke
 D745,645 S 12/2015 Burke
 D794,168 S * 8/2017 Starck D23/280.1
 D827,791 S 9/2018 Bowen et al.

FOREIGN PATENT DOCUMENTS

GB 4007911 S 6/2008

* cited by examiner

Primary Examiner — Robert A Delehanty
 (74) *Attorney, Agent, or Firm* — The Webb Law Firm

(21) Appl. No.: **29/671,418**
 (22) Filed: **Nov. 27, 2018**
 (51) **LOC (12) Cl.** **23-02**
 (52) **U.S. Cl.**
 USPC **D23/280.1**
 (58) **Field of Classification Search**
 USPC D23/277, 280.1
 CPC A61H 2035/004
 See application file for complete search history.

(57) **CLAIM**

The ornamental design for a bathtub, as shown and described.

DESCRIPTION

FIG. 1 is an upper front perspective view of a bathtub showing my new design in accordance with a first embodiment of the invention;
 FIG. 2 is an upper left perspective view thereof;
 FIG. 3 is a front elevation view thereof;
 FIG. 4 is a rear elevation view thereof;
 FIG. 5 is a left side elevation view thereof;
 FIG. 6 is a right side elevation view thereof;
 FIG. 7 is a top view thereof; and,
 FIG. 8 is a bottom view thereof.
 The portions of the bathtub shown in broken lines form no part of the claimed design.

(56) **References Cited**

U.S. PATENT DOCUMENTS

D32,411 S 3/1900 Scott
 D32,713 S 5/1900 Bowman
 D32,858 S 6/1900 Wells
 D36,881 S 4/1904 Weelans
 4,535,489 A 8/1985 Elkins
 D444,861 S * 7/2001 Smith D23/277
 D631,949 S 2/2011 Richmond
 D654,991 S 2/2012 Oliveira
 D724,706 S 3/2015 Meneghello et al.
 D726,292 S 4/2015 Spangler

1 Claim, 7 Drawing Sheets

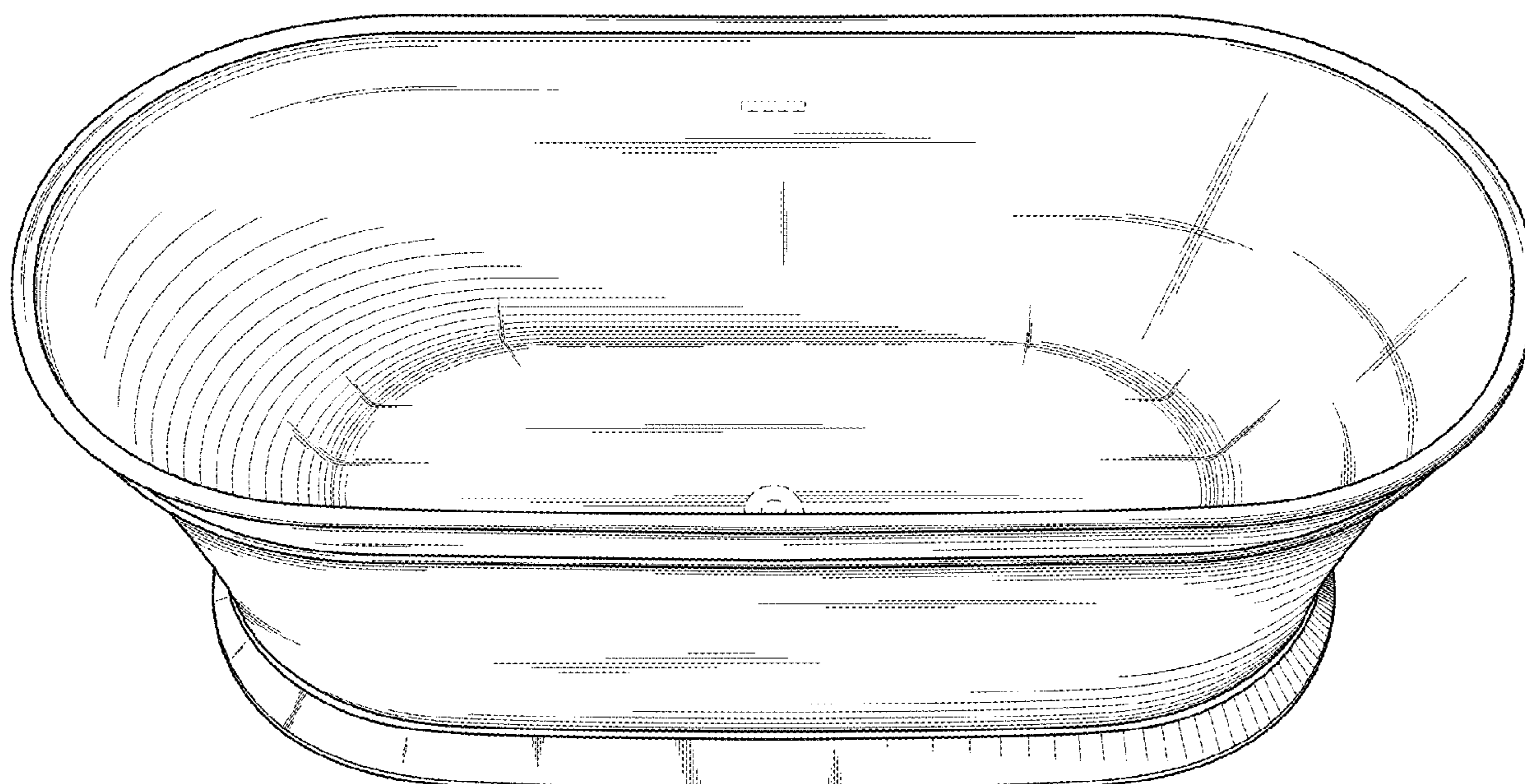

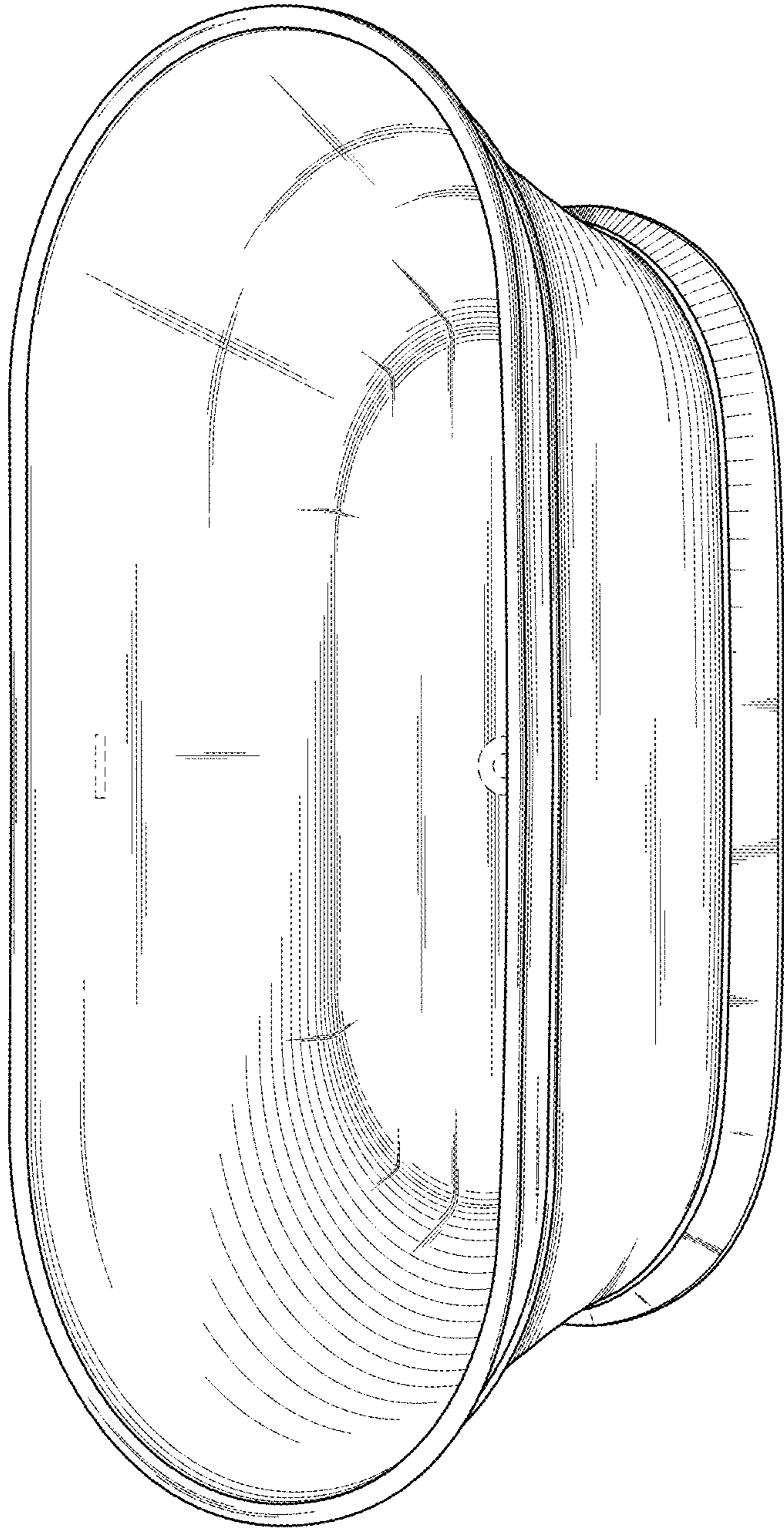

FIG. 1

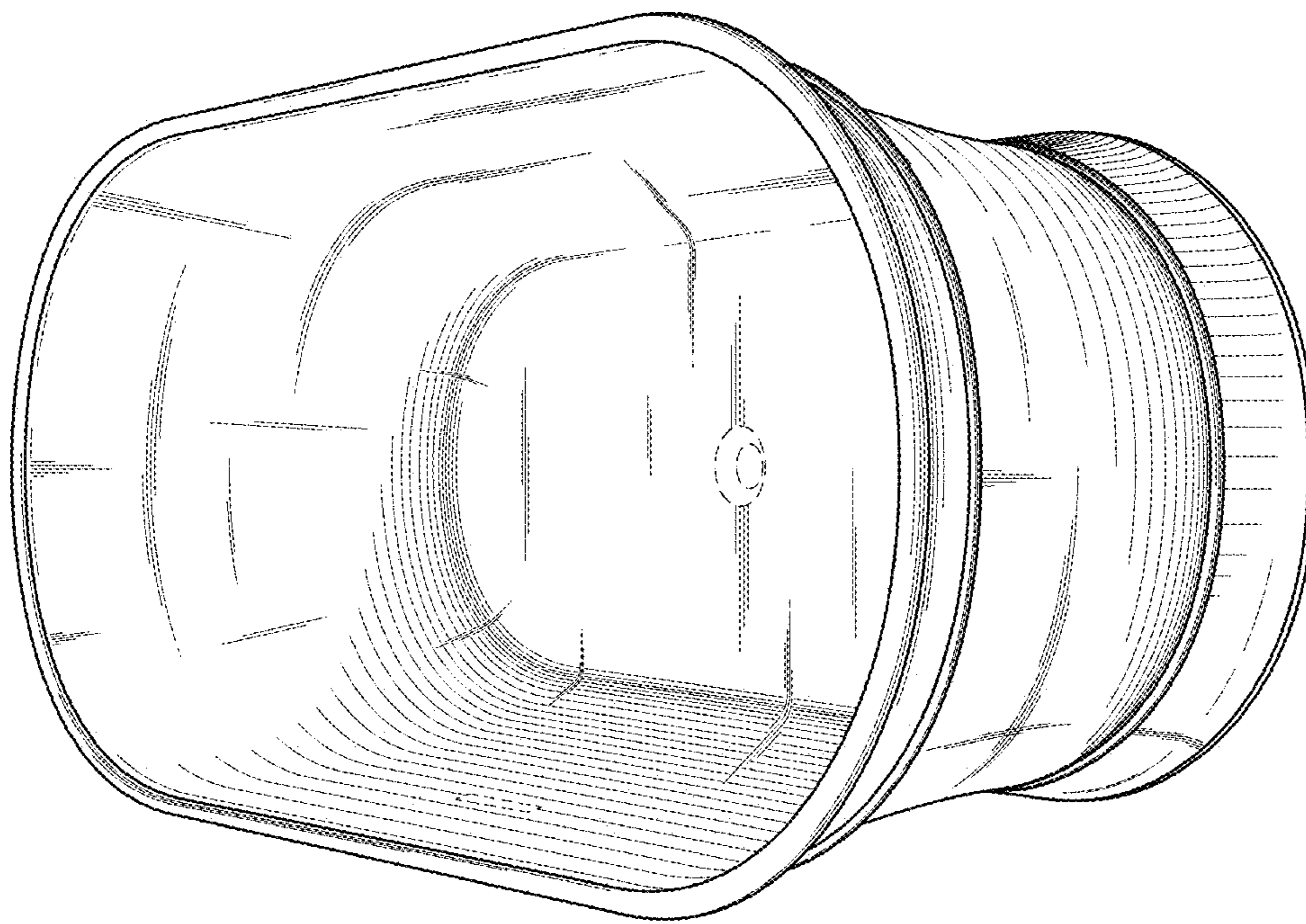

FIG. 2

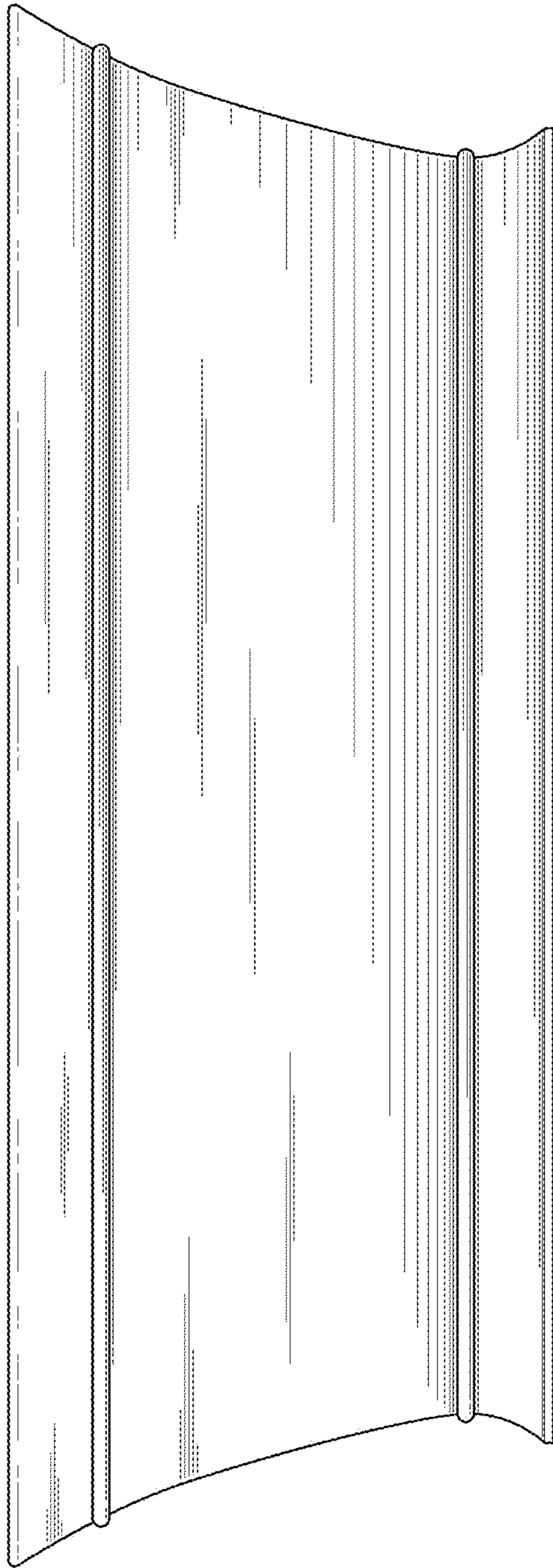

FIG. 3

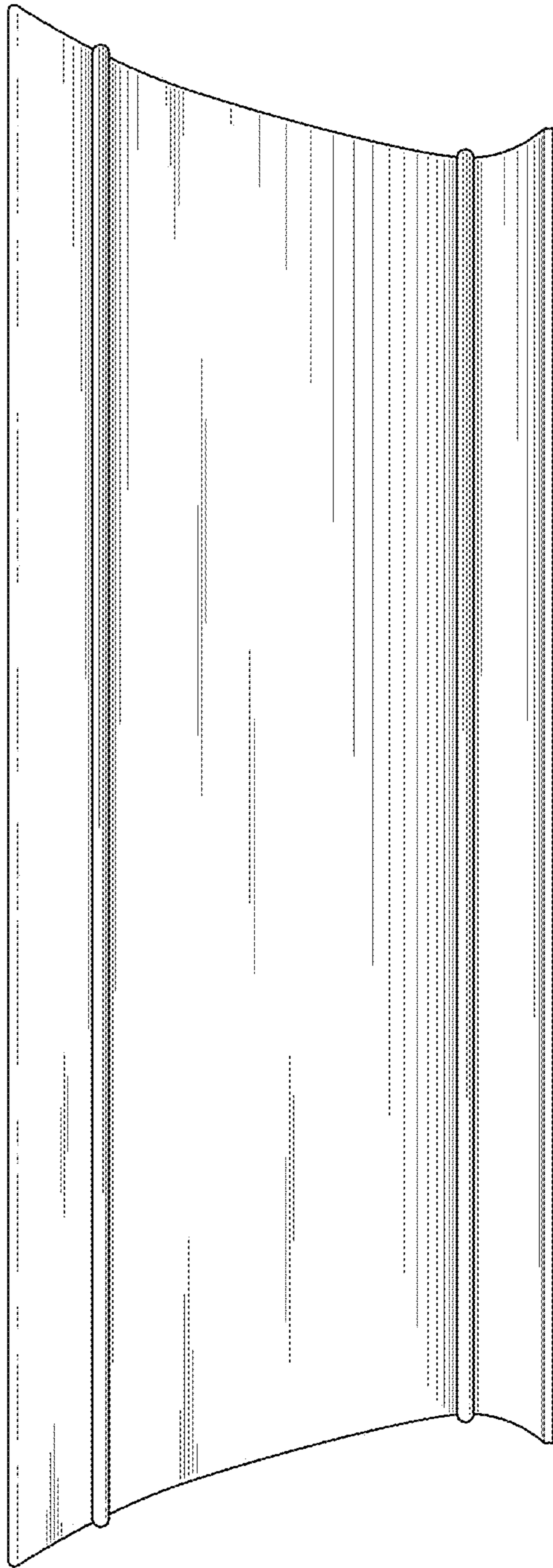

FIG. 4

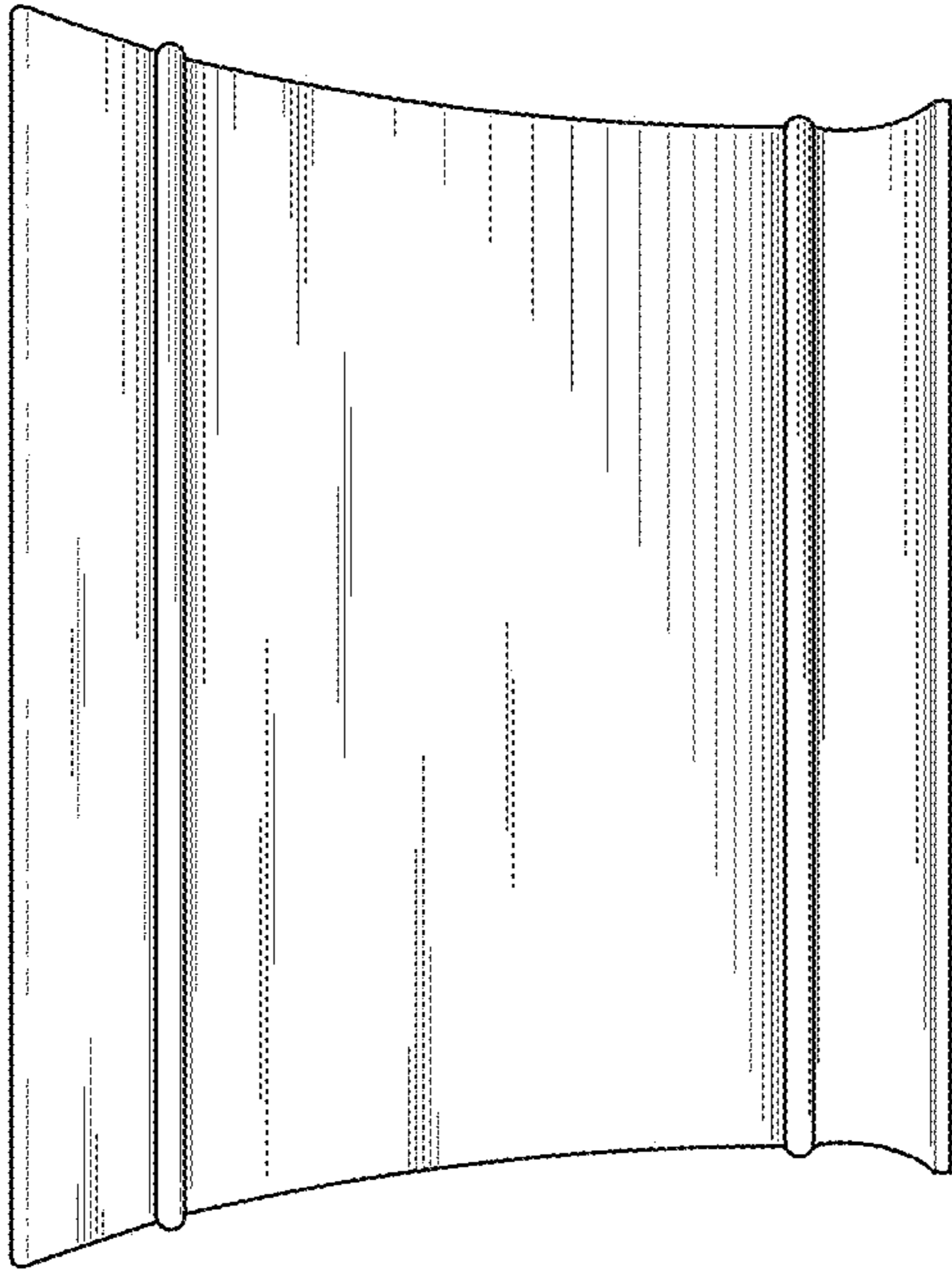

FIG. 5

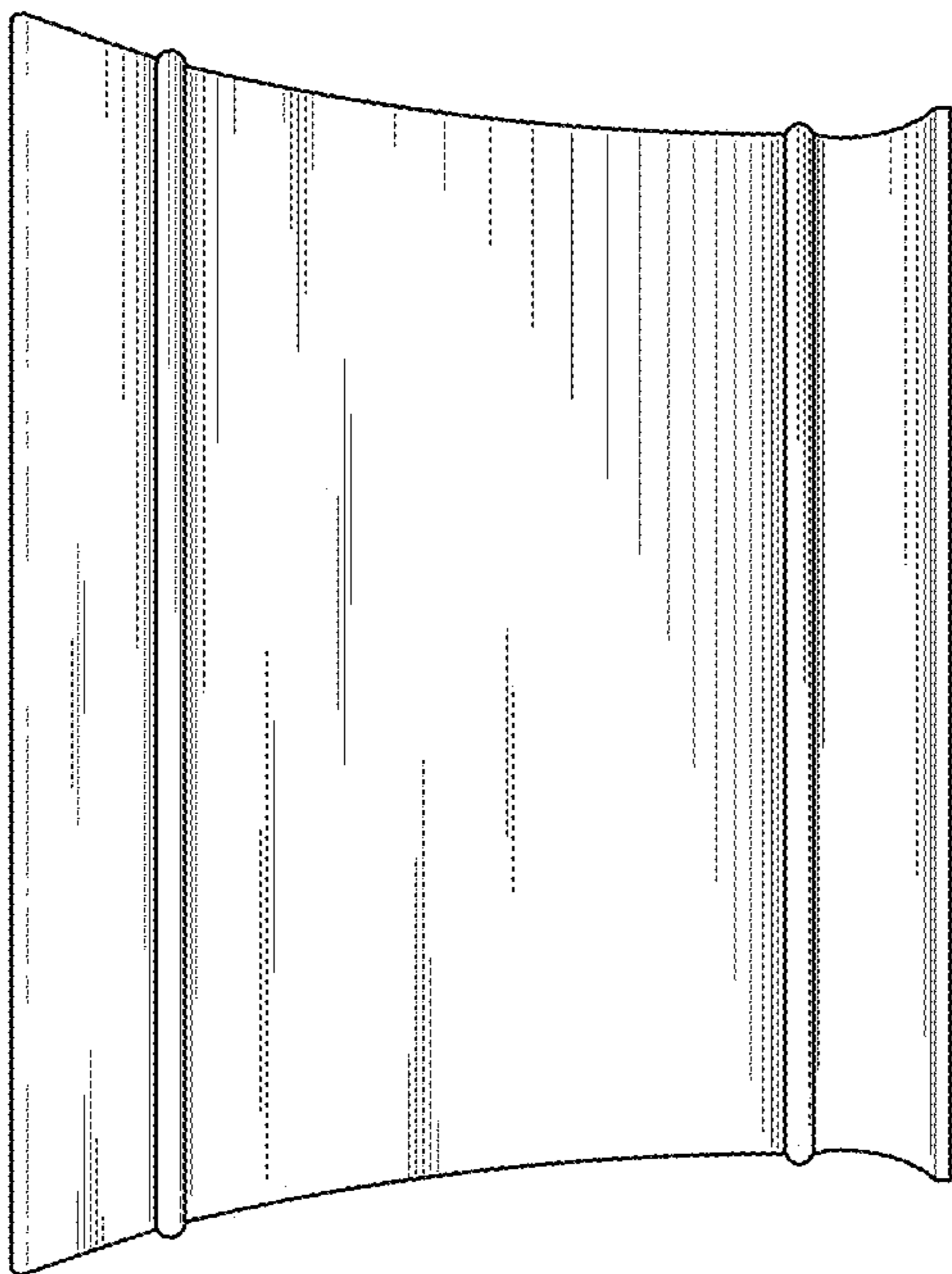

FIG. 6

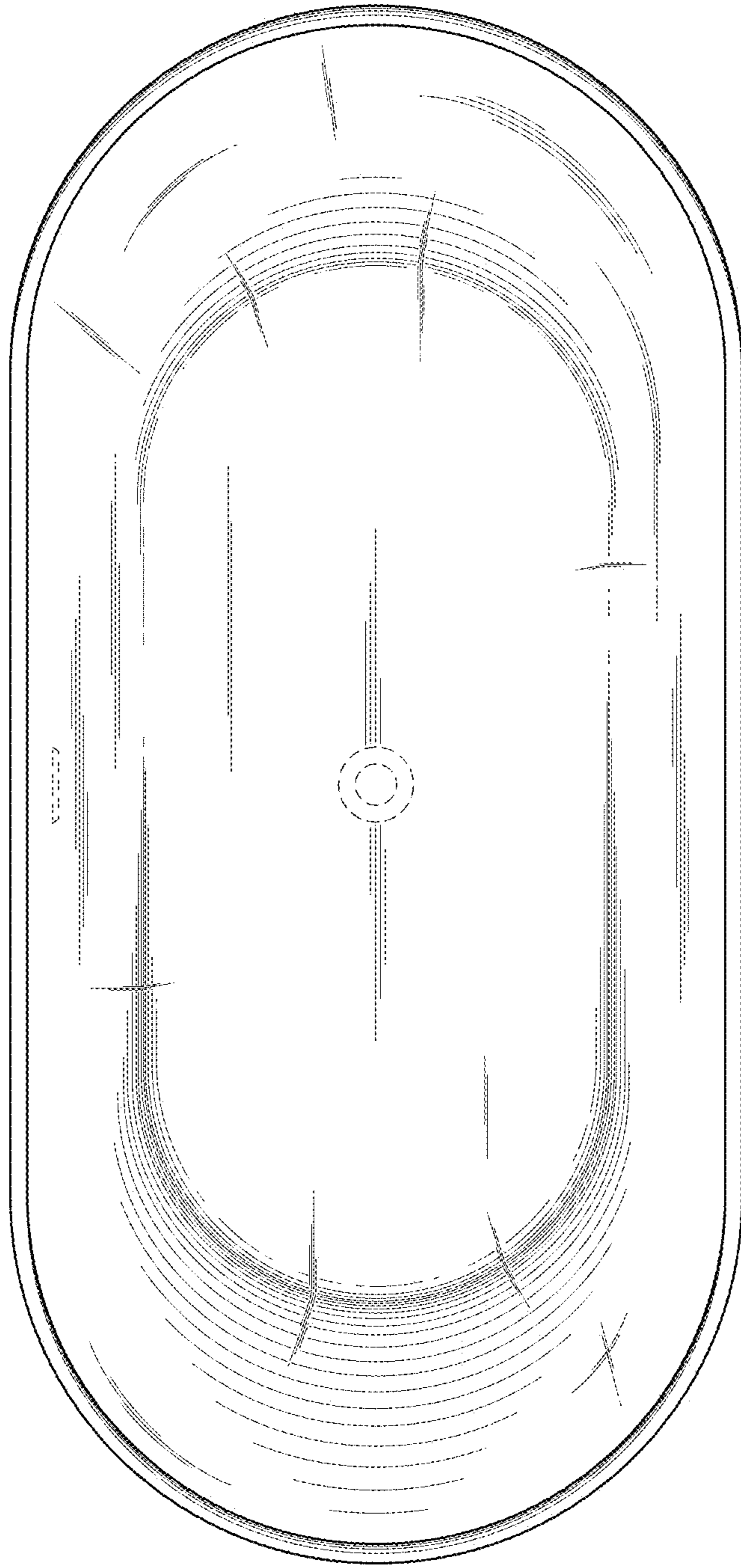

FIG. 7

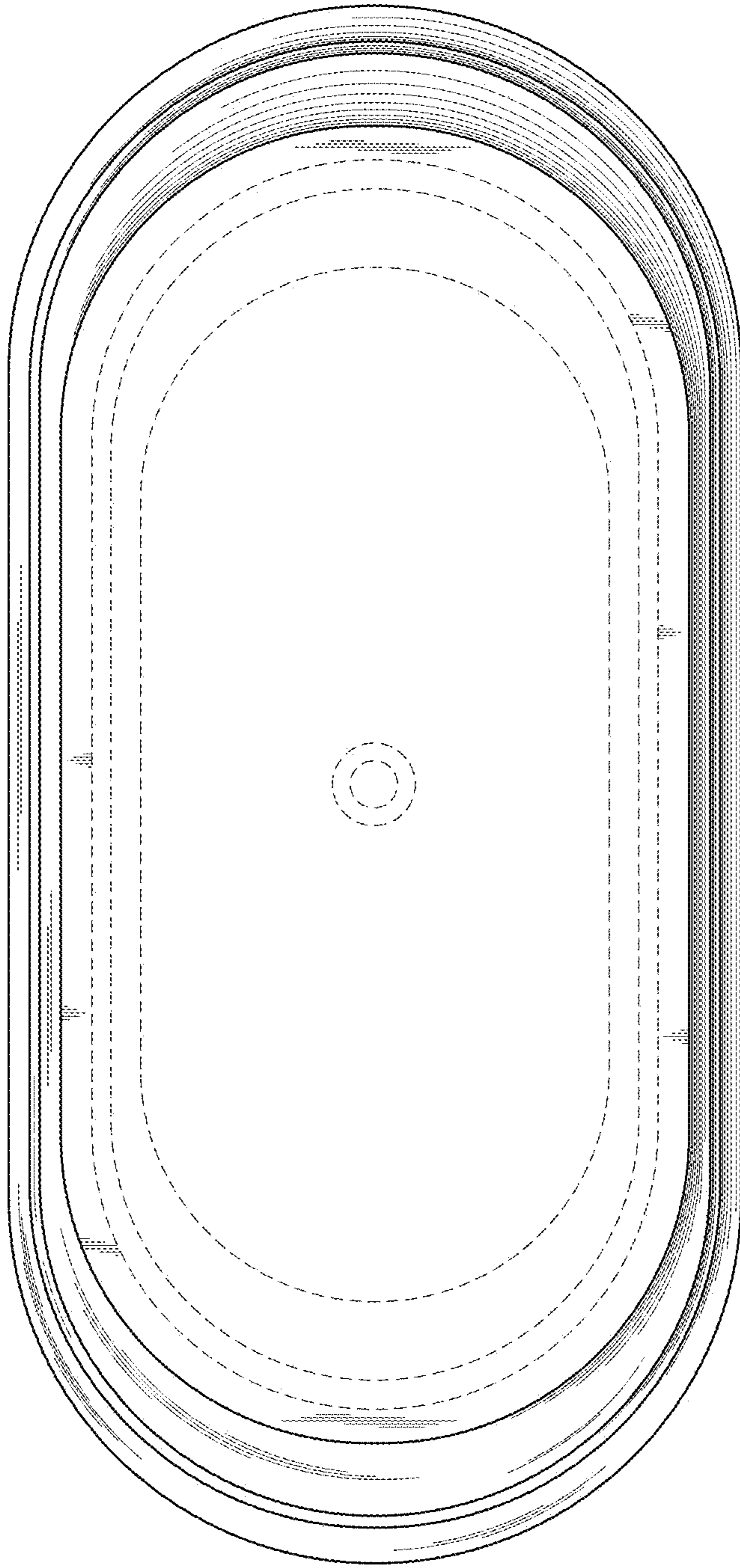

FIG. 8