



US00D895078S

(12) **United States Design Patent** (10) **Patent No.:** **US D895,078 S**
Bergmann (45) **Date of Patent:** **** Sep. 1, 2020**

(54) **SHOWER WITH BATH**

(71) Applicant: **Duravit Aktiengesellschaft**, Hornberg (DE)

(72) Inventor: **Martin Bergmann**, Vienna (AT)

(73) Assignee: **Duravit Aktiengesellschaft**, Hornberg (DE)

(**) Term: **15 Years**

(21) Appl. No.: **29/622,206**

(22) Filed: **Oct. 16, 2017**

(30) **Foreign Application Priority Data**

May 24, 2017 (WO) DM/096340

(51) **LOC (12) Cl.** **23-02**

(52) **U.S. Cl.**
USPC **D23/279**

(58) **Field of Classification Search**
USPC ... D23/277-279, 280.1, 280.2, 280.3, 280.4,
D23/304-310, 283

(Continued)

(56) **References Cited**

U.S. PATENT DOCUMENTS

D248,107 S * 6/1978 Brendgord D23/279
D354,555 S * 1/1995 Salach D23/277

(Continued)

Primary Examiner — Lakiya G Rogers

Assistant Examiner — John A Voytek

(74) *Attorney, Agent, or Firm* — Florek & Endres PLLC

(57) **CLAIM**

The ornamental design for a shower with bath, as shown and described.

DESCRIPTION

FIG. 1 is a perspective view of the shower with bath of the present invention shown with a backrest in a deployed position.

FIG. 2 is a perspective view of the shower with bath of the present invention shown with a backrest in an alternate deployed position.

FIG. 3 is a perspective view of the shower with bath of the present invention shown with the backrest in a stowed position.

FIG. 4 is a perspective view of the shower with bath of the present invention shown with the backrest removed.

FIG. 5 is a front elevation view of the shower with bath of the present invention shown with a backrest in a deployed position.

FIG. 6 is a front elevation view of the shower with bath of the present invention shown with a backrest in an alternate deployed position.

FIG. 7 is a front elevation view of the shower with bath of the present invention shown with the backrest in a stowed position.

FIG. 8 is a front elevation view of the shower with bath of the present invention shown with the backrest removed.

FIG. 9 is a rear elevation view of the shower with bath of the present invention shown with the backrest in a stowed position.

FIG. 10 is a rear elevation view of the shower with bath of the present invention shown with the backrest removed.

FIG. 11 is a top plan view of the shower with bath of the present invention shown with the backrest in a stowed position.

FIG. 12 is a top plan view of the shower with bath of the present invention shown with the backrest removed.

FIG. 13 is a right side elevation view of the shower with bath of the present invention with the backrest in a stowed position.

FIG. 14 is a right side elevation view of the shower with bath of the present invention with the backrest removed.

FIG. 15 is a left side elevation view of the shower with bath of the present invention with the backrest in a stowed position; and,

FIG. 16 is a left side elevation view of the shower with bath of the present invention with the backrest removed.

The broken lines of the drawings form no part of the claimed design.

1 Claim, 16 Drawing Sheets

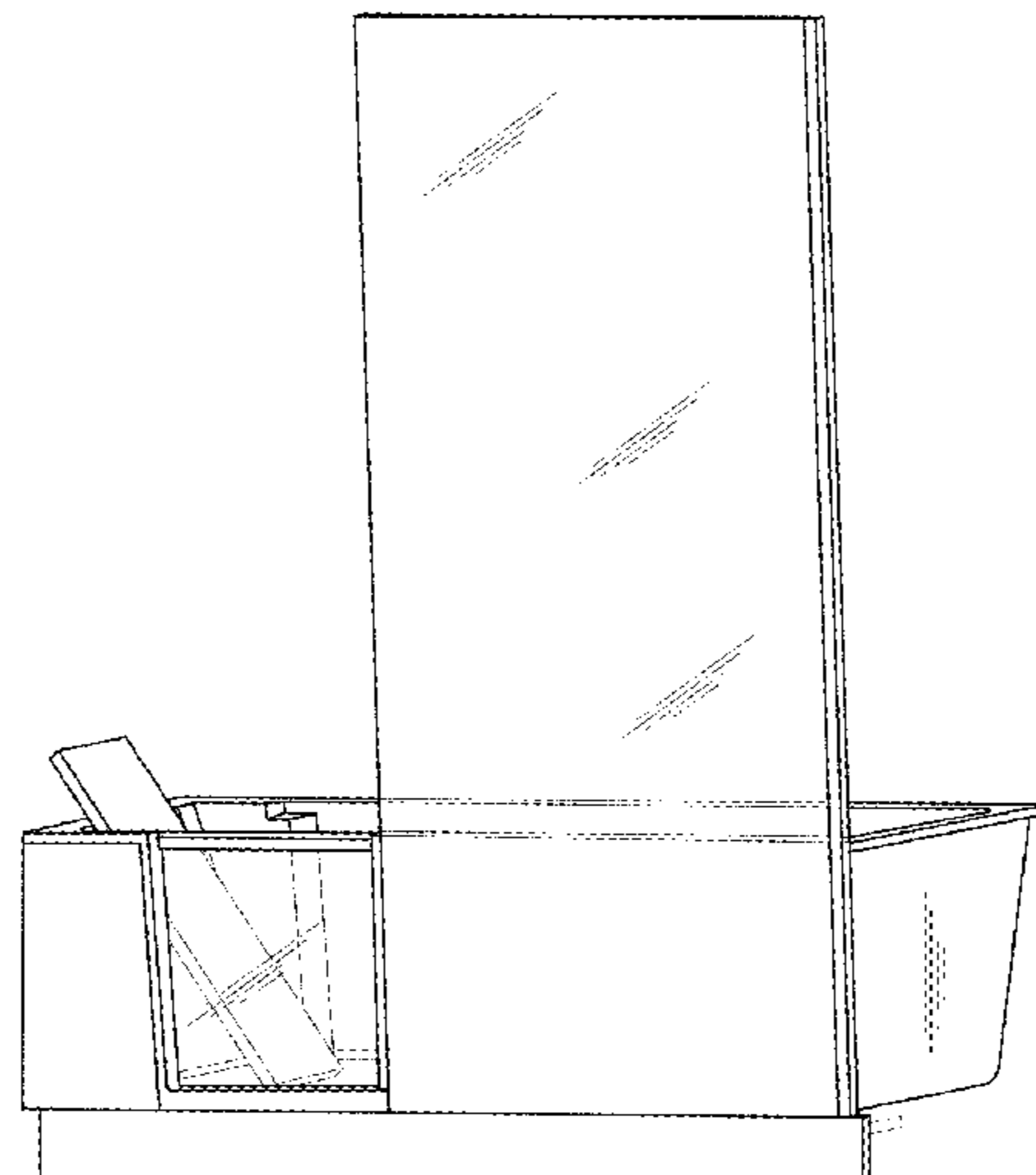

(58) **Field of Classification Search**

CPC A47K 3/006; A47K 3/02; A47K 3/022;
E05C 9/16

See application file for complete search history.

(56) **References Cited**

U.S. PATENT DOCUMENTS

D379,216	S *	5/1997	Salach	D23/277
D622,363	S *	8/2010	Zierler	D23/279
9,254,066	B2 *	2/2016	Torres	A47K 3/006
9,392,912	B2 *	7/2016	Haddad	A47K 3/006
D842,972	S *	3/2019	O'Brien	D23/279
2008/0083063	A1 *	4/2008	Libit	A47K 3/006 4/571.1
2011/0167555	A1 *	7/2011	Zierler	A47K 3/006 4/555
2012/0198611	A1 *	8/2012	Zierler	A47K 3/006 4/555
2013/0086738	A1 *	4/2013	Millerd	A47K 3/02 4/555
2014/0101841	A1 *	4/2014	Bentley	A47K 3/006 4/556
2015/0107017	A1 *	4/2015	Haddad	A47K 3/022 4/556

* cited by examiner

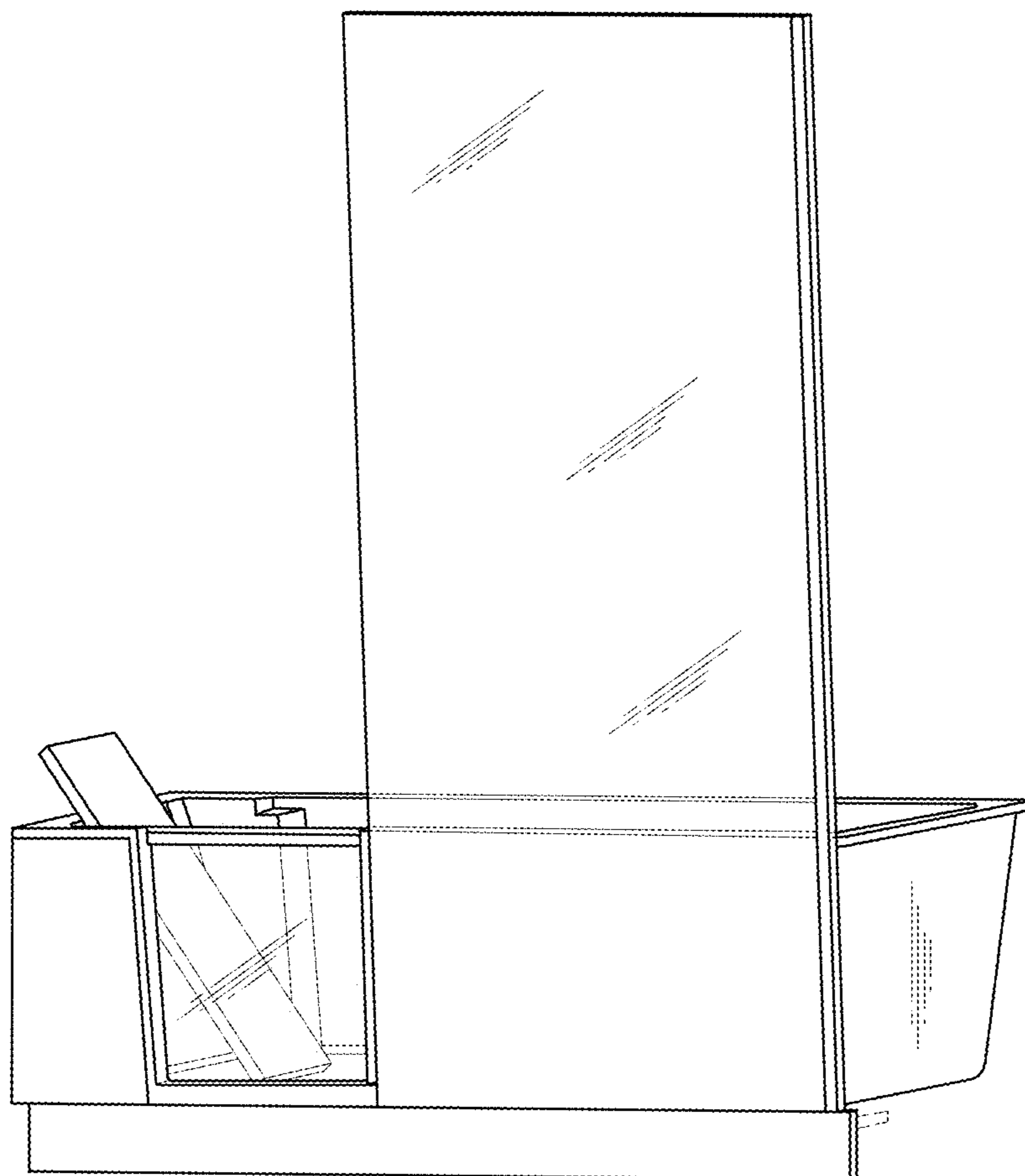

FIG. 1

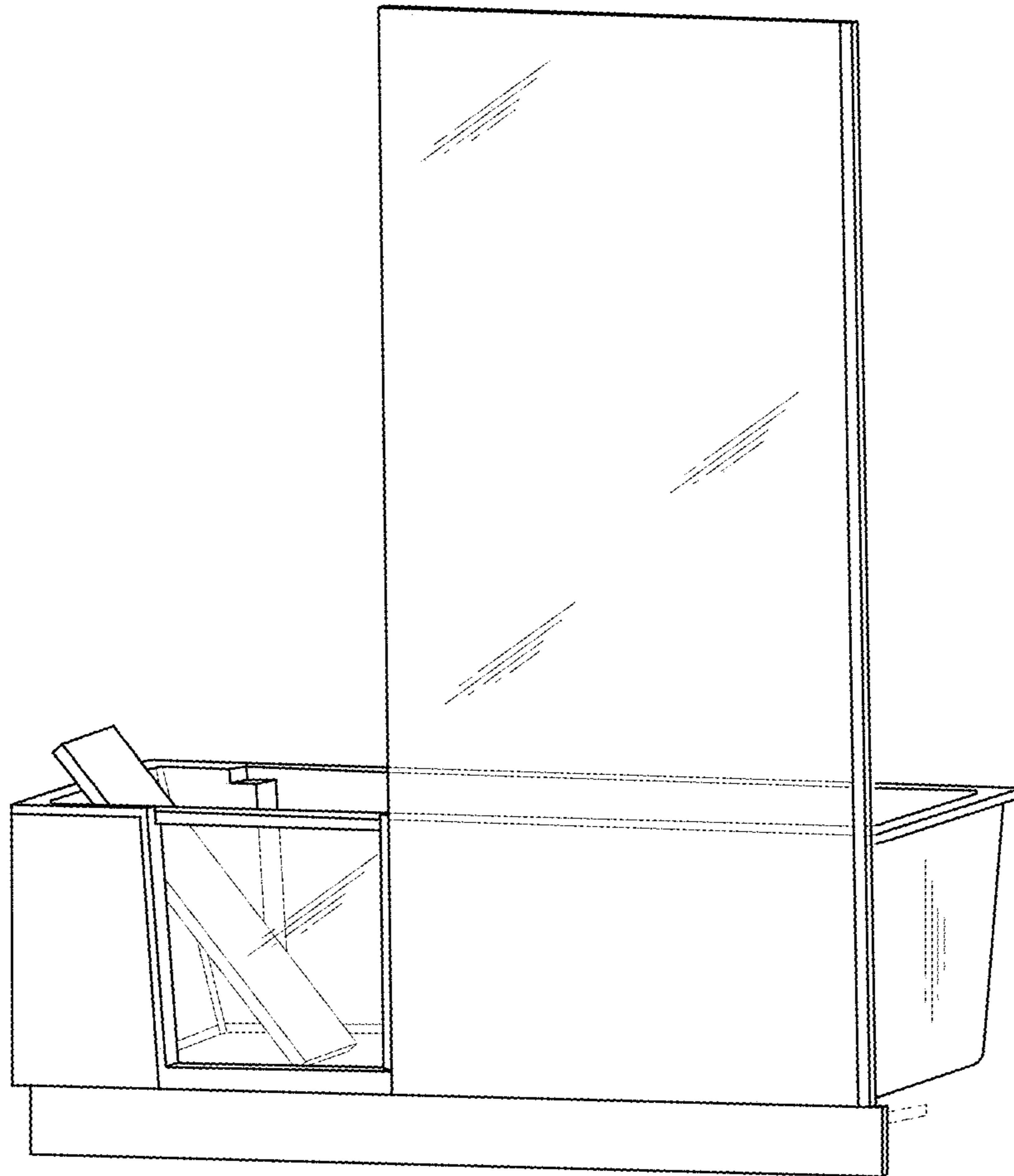

FIG. 2

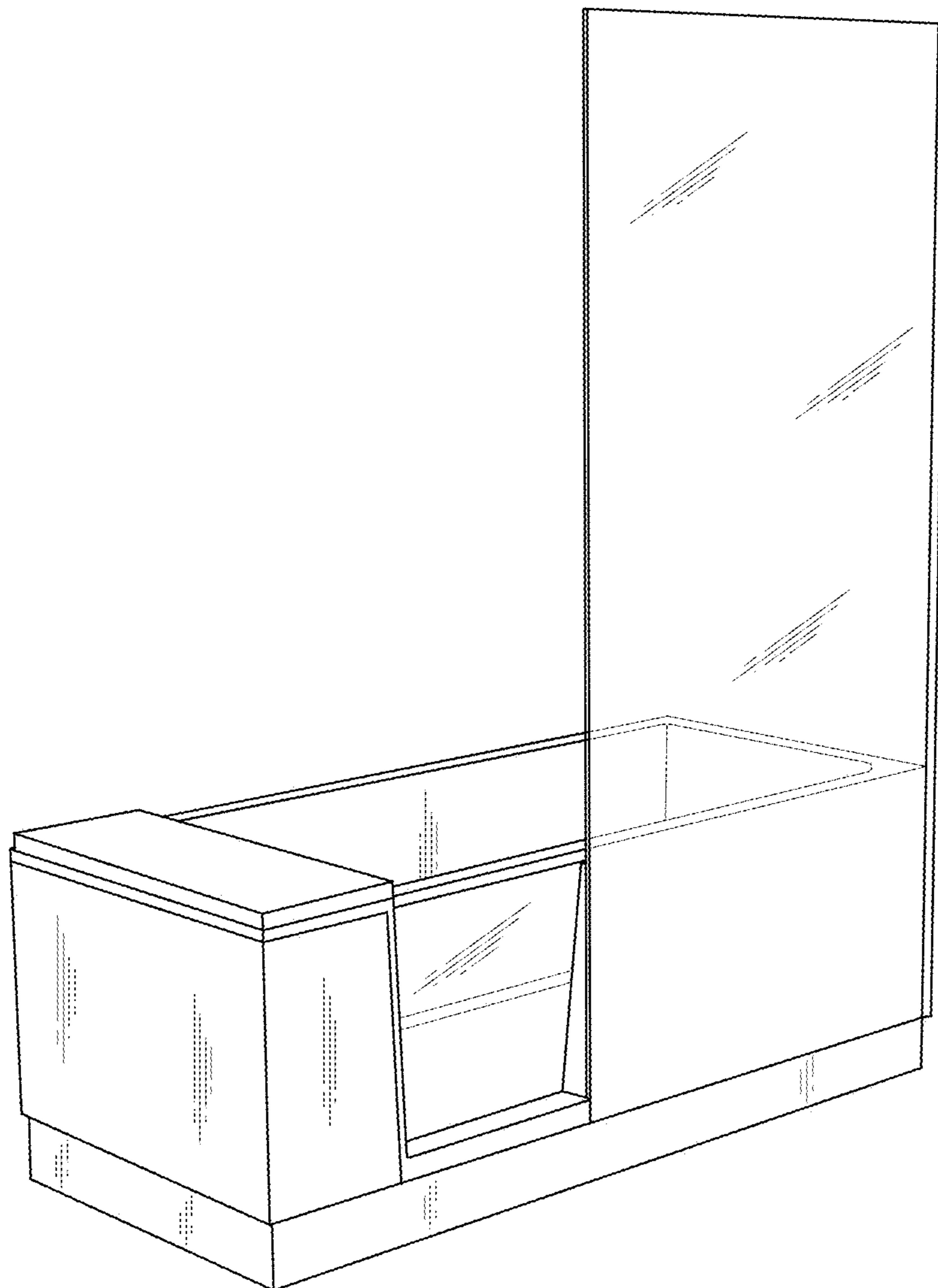

FIG. 3

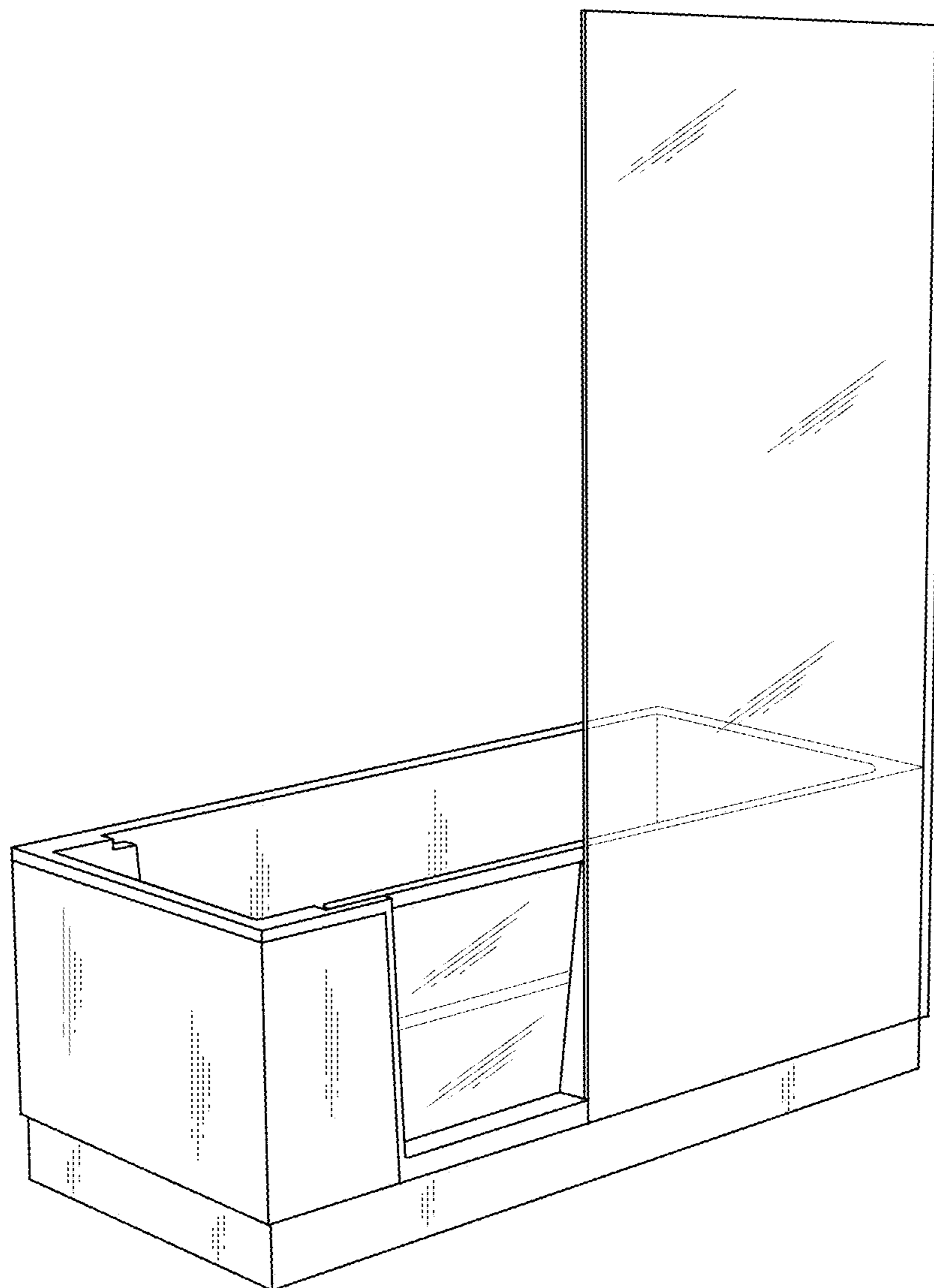

FIG. 4

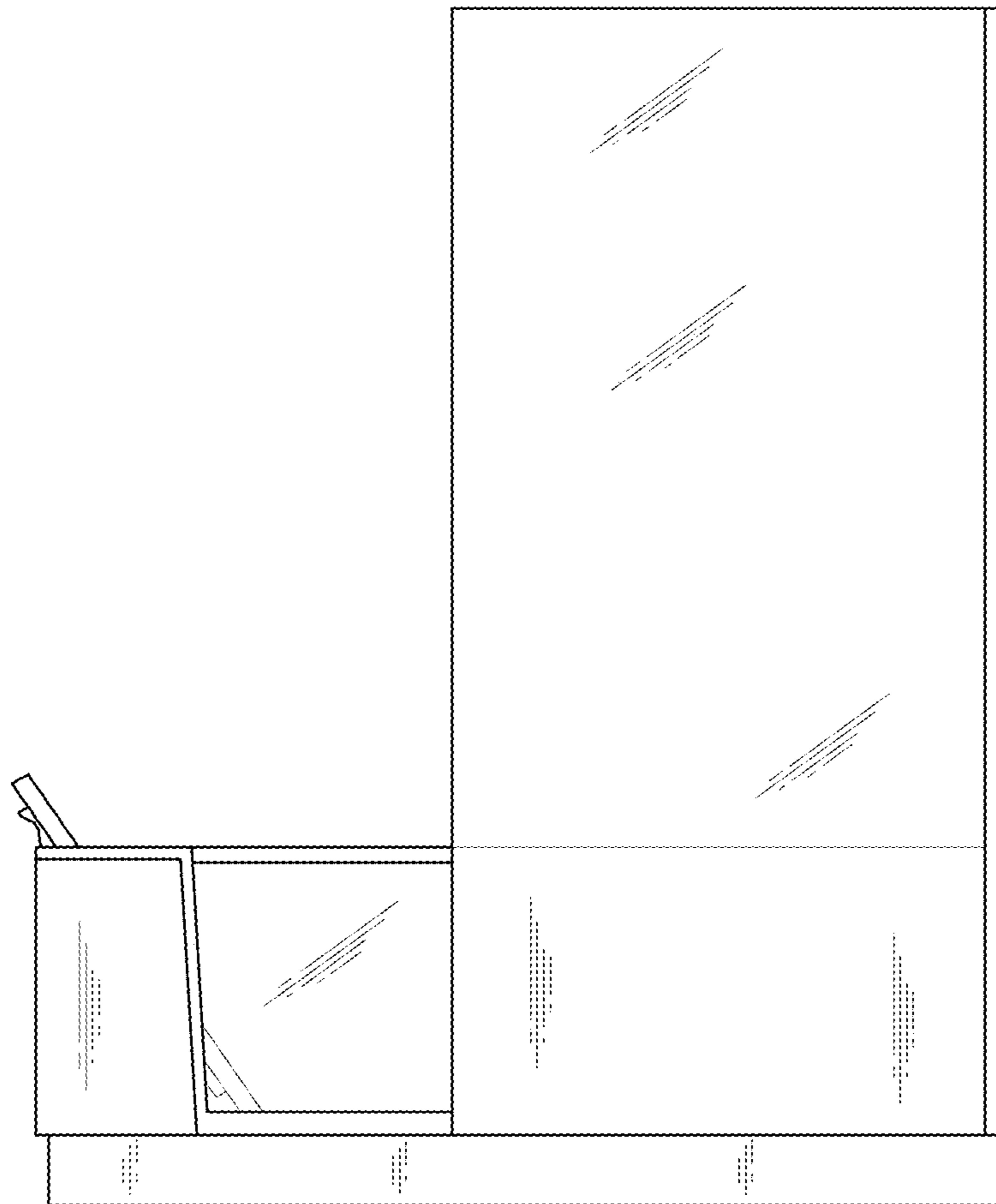

FIG. 5

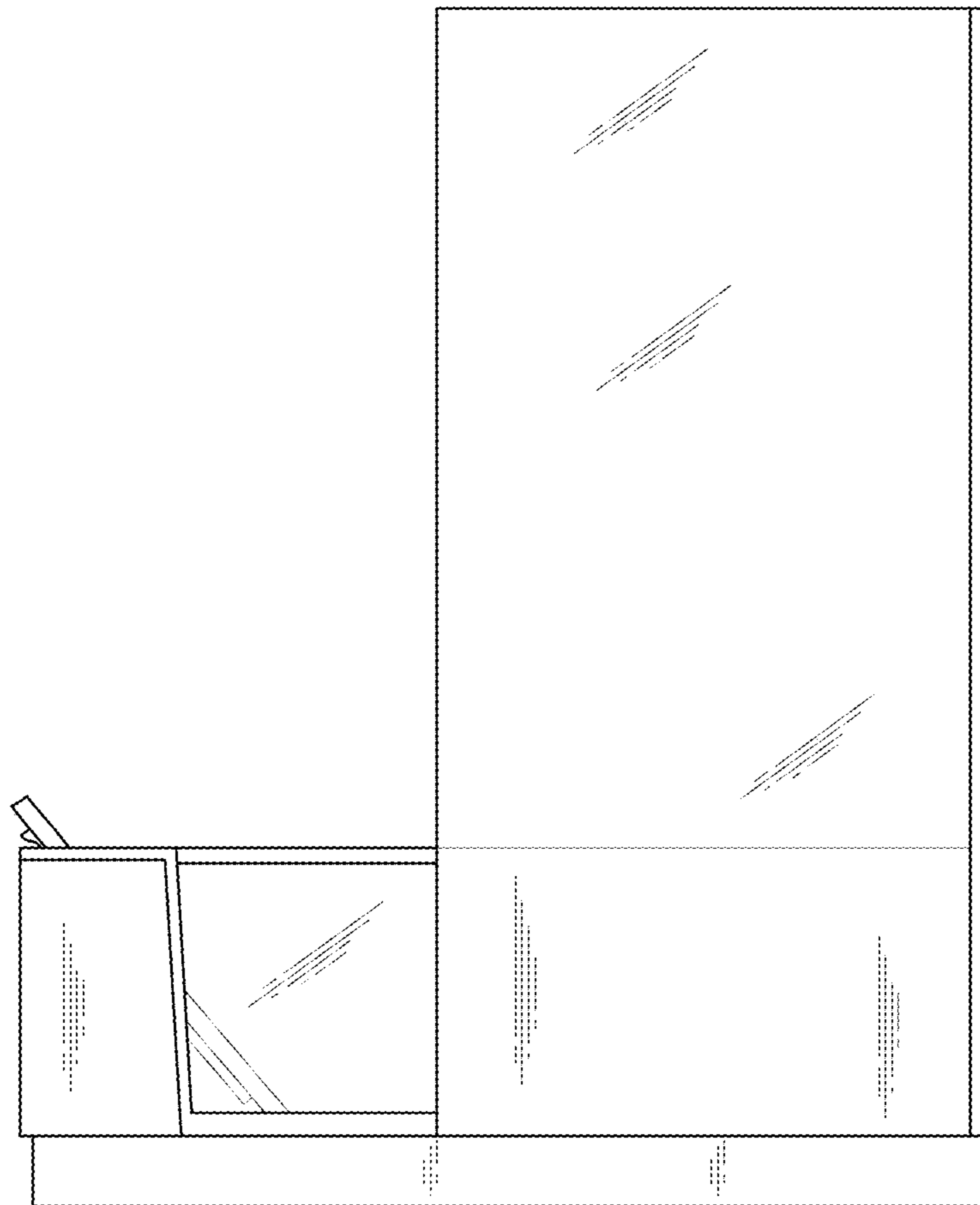

FIG. 6

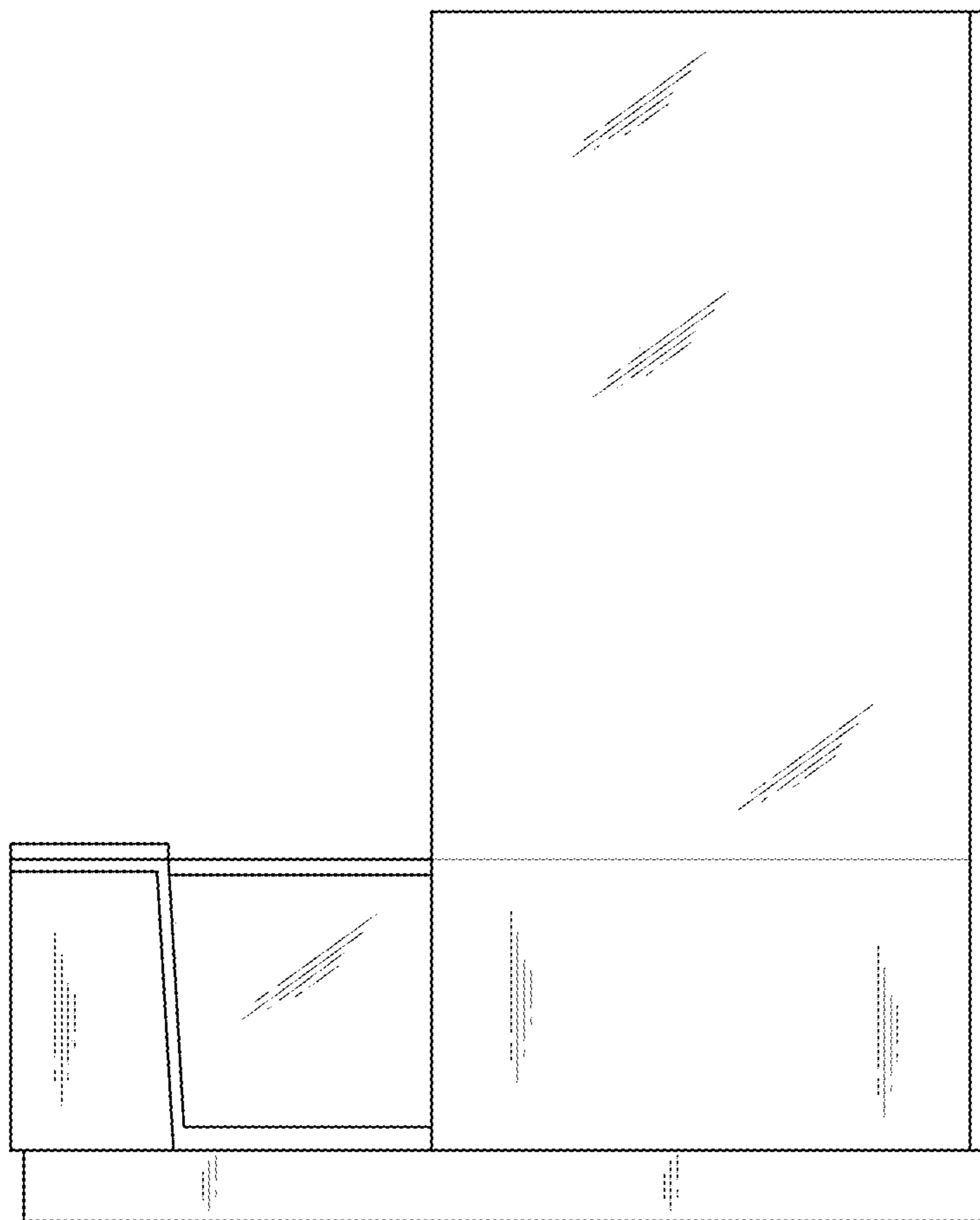

FIG. 7

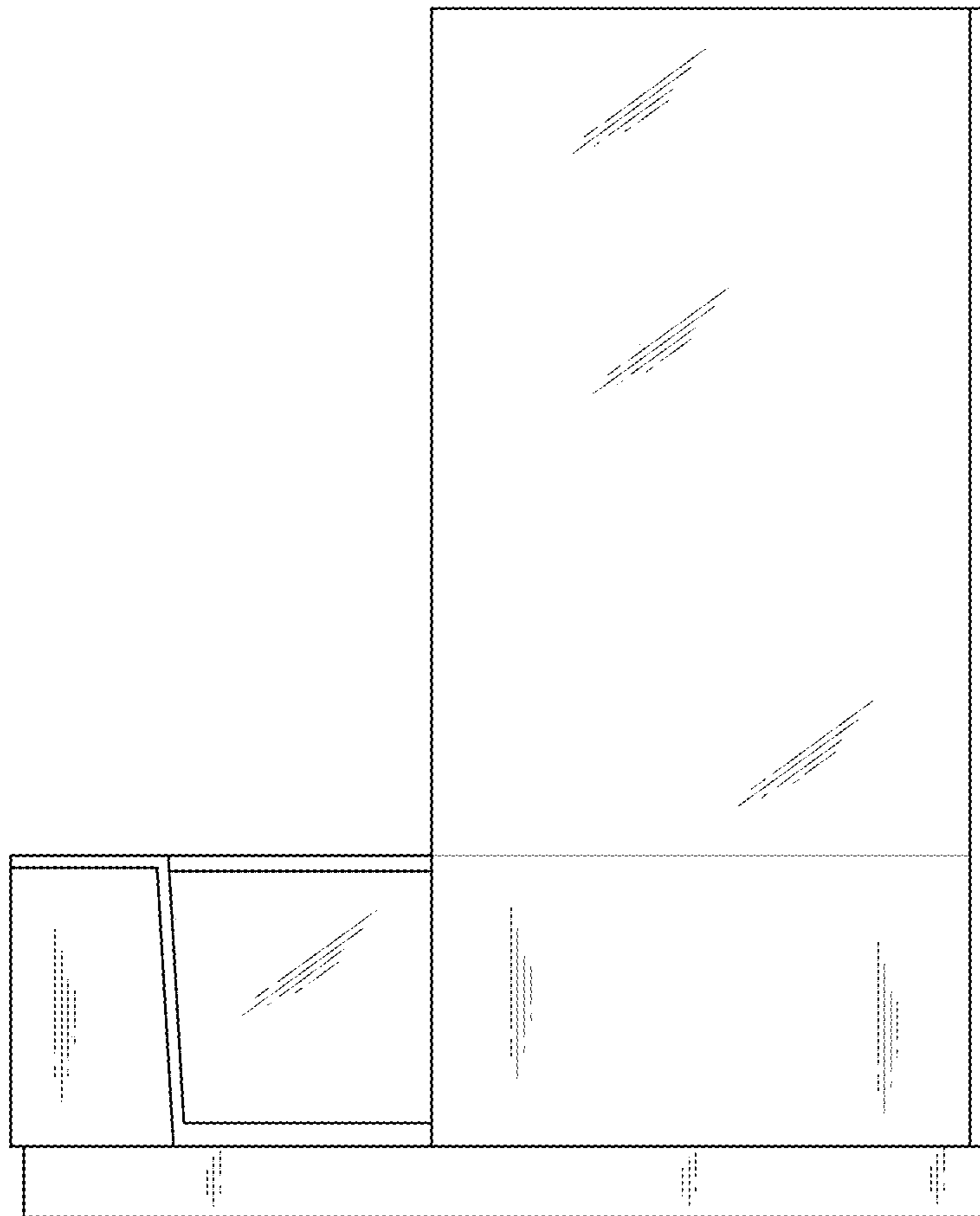

FIG. 8

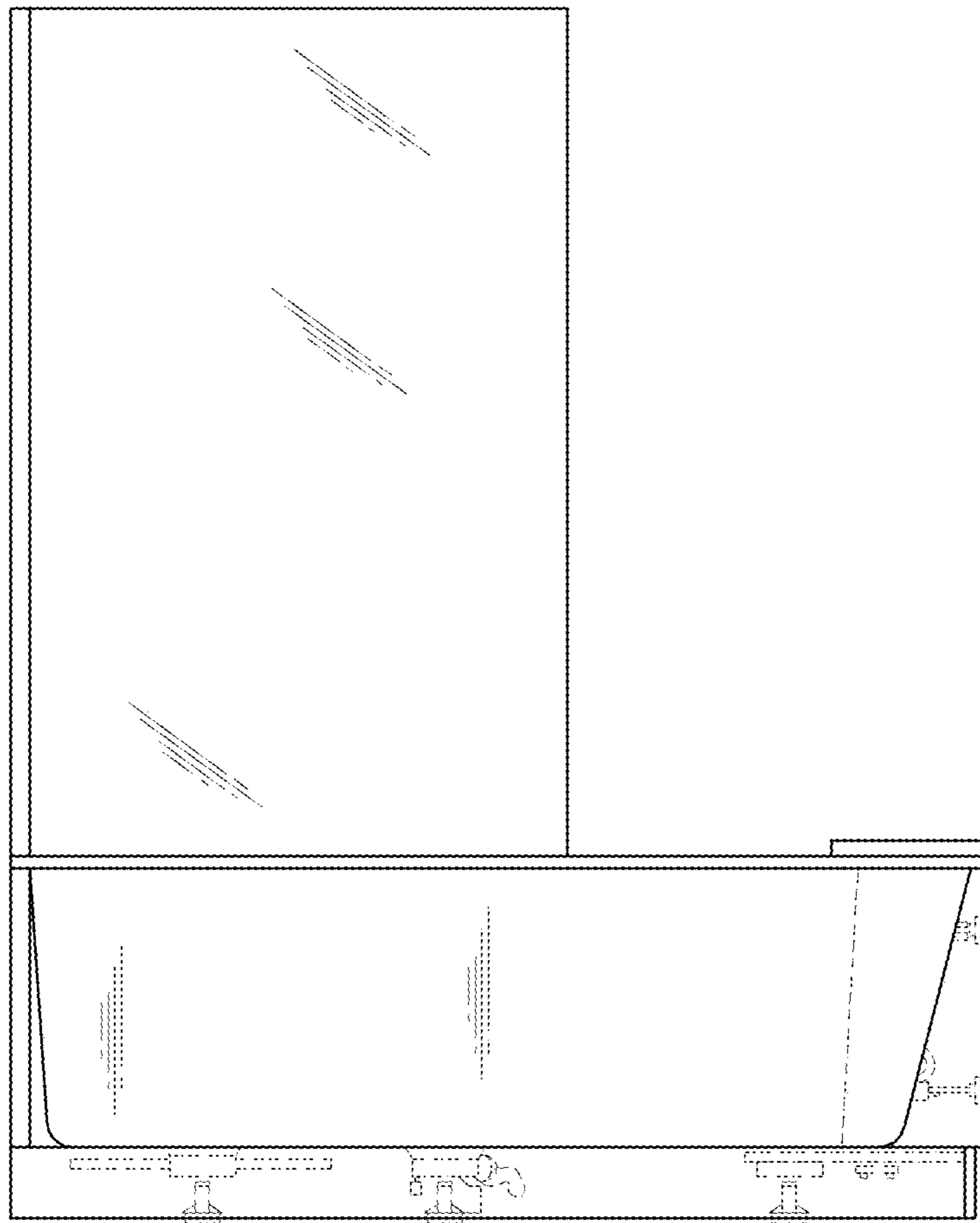

FIG. 9

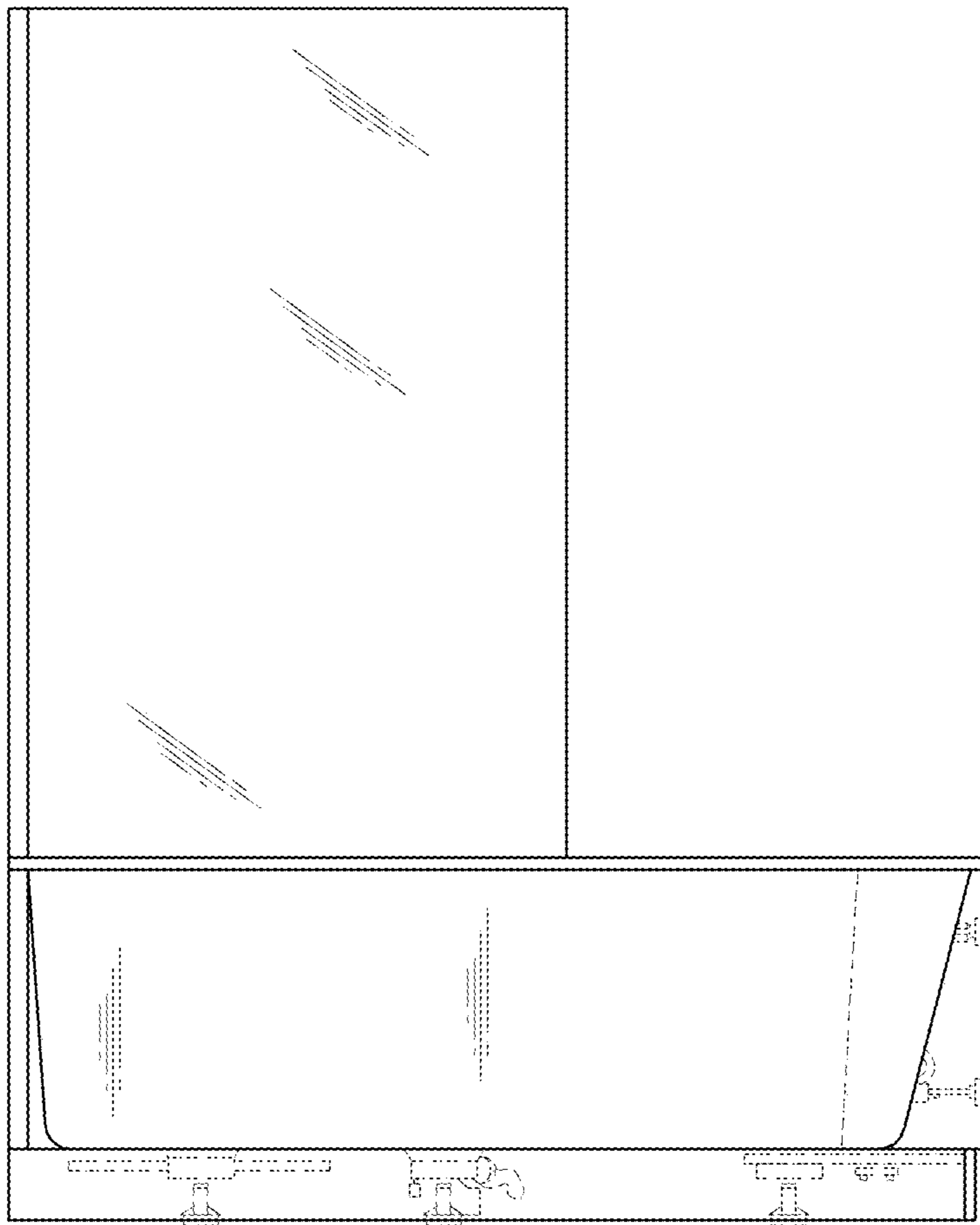

FIG. 10

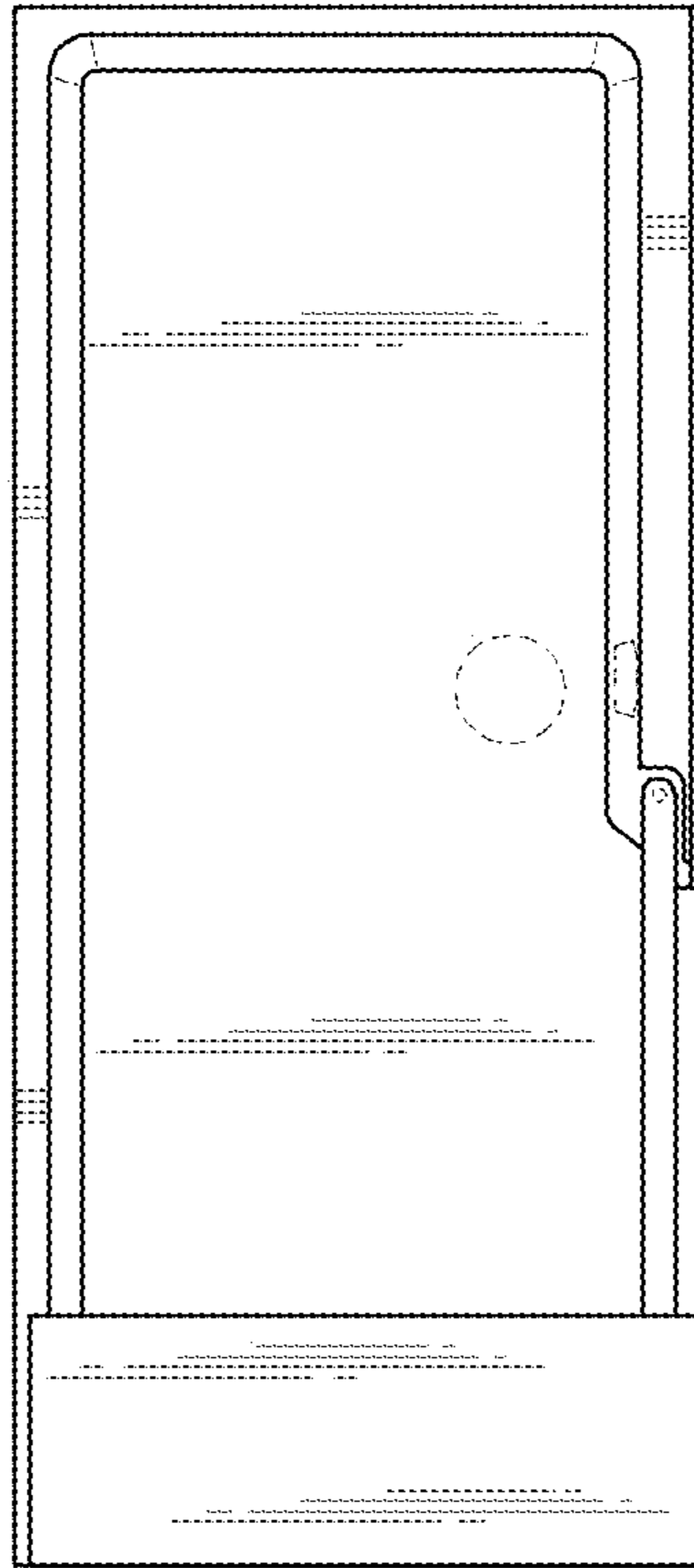

FIG. 11

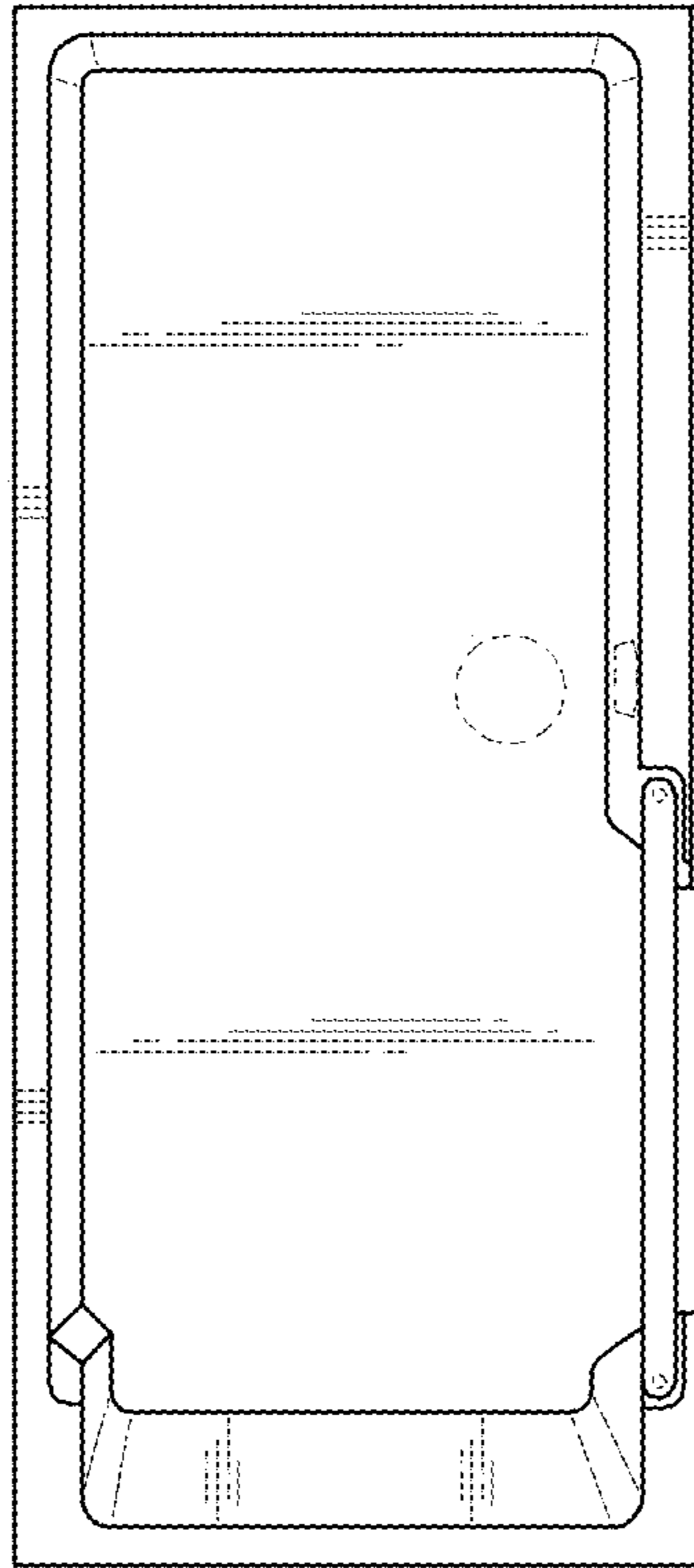

FIG. 12

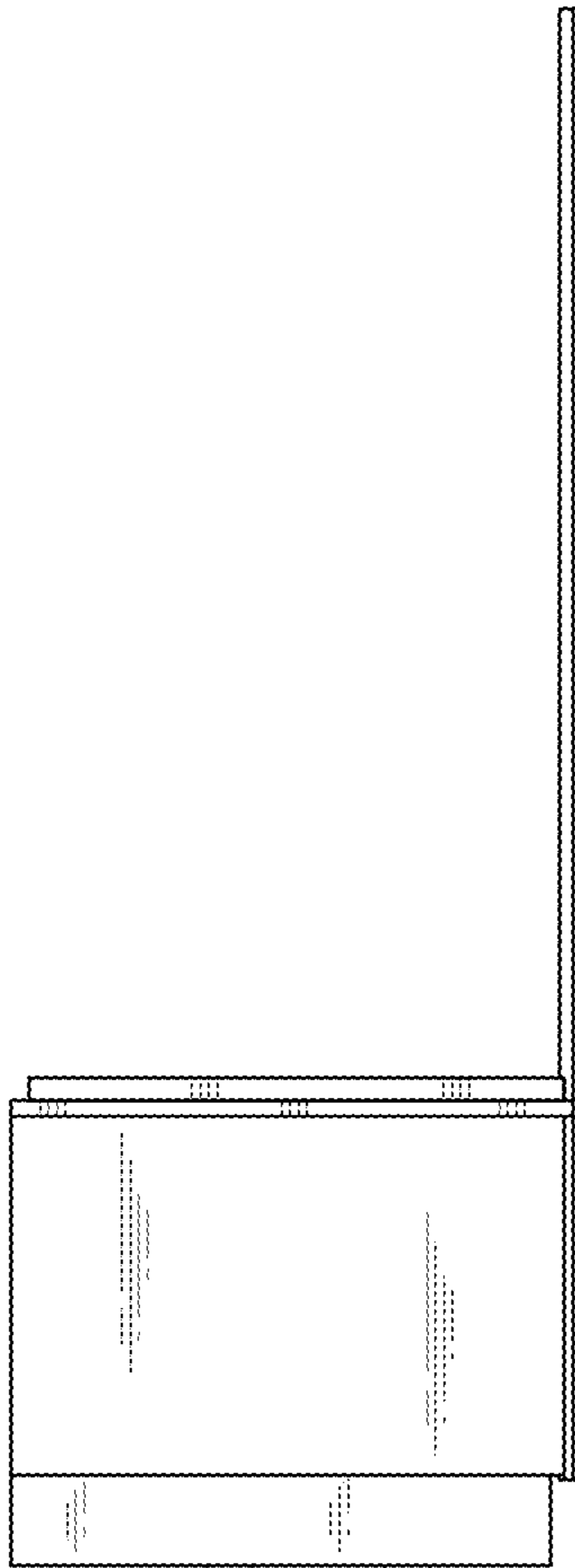

FIG. 13

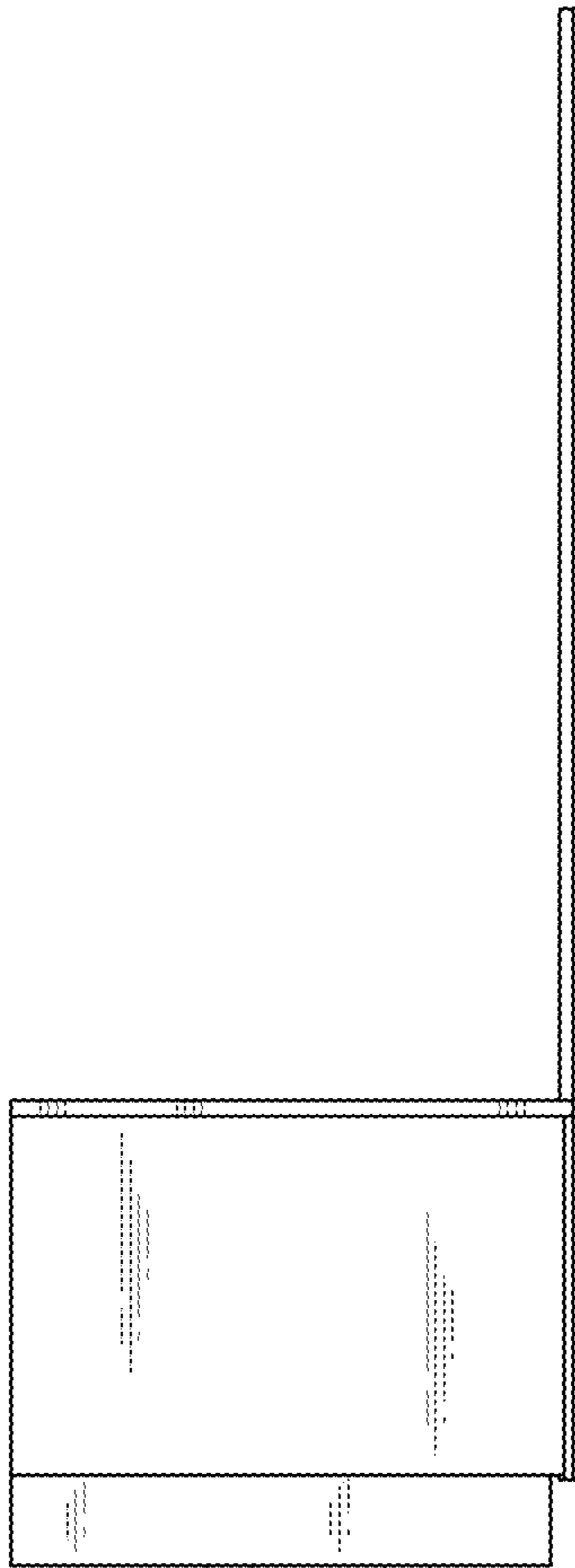

FIG. 14

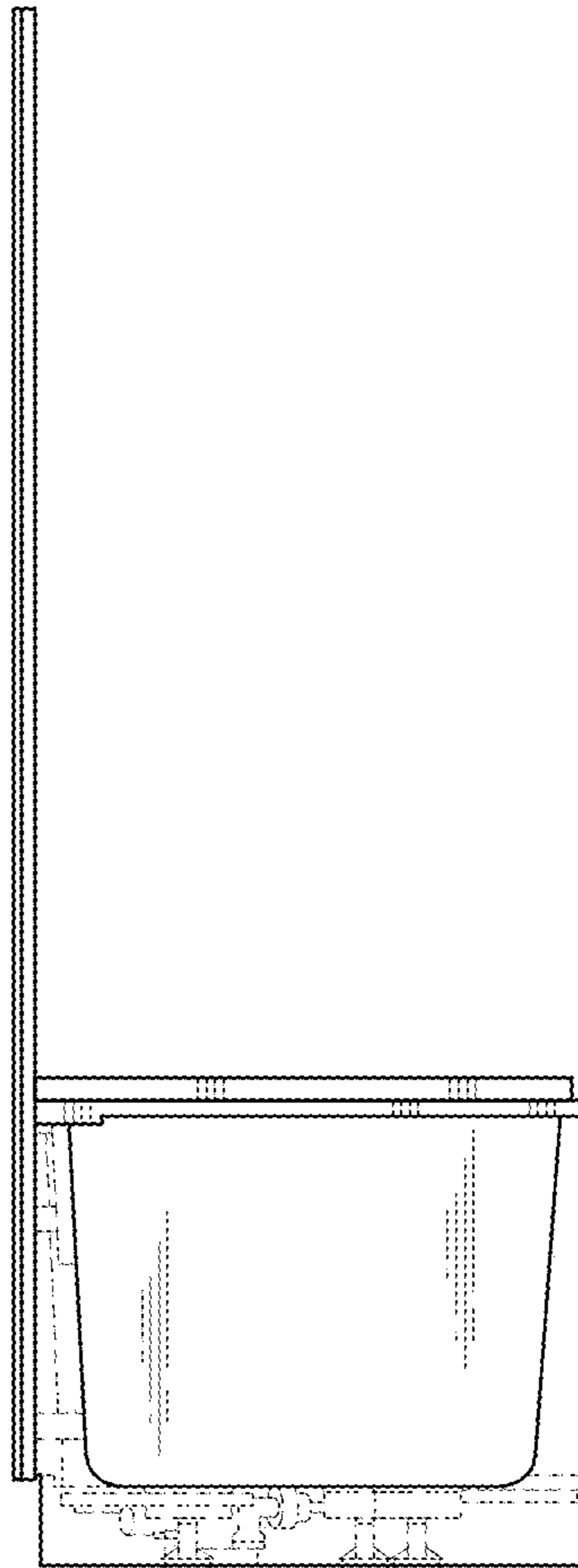

FIG. 15

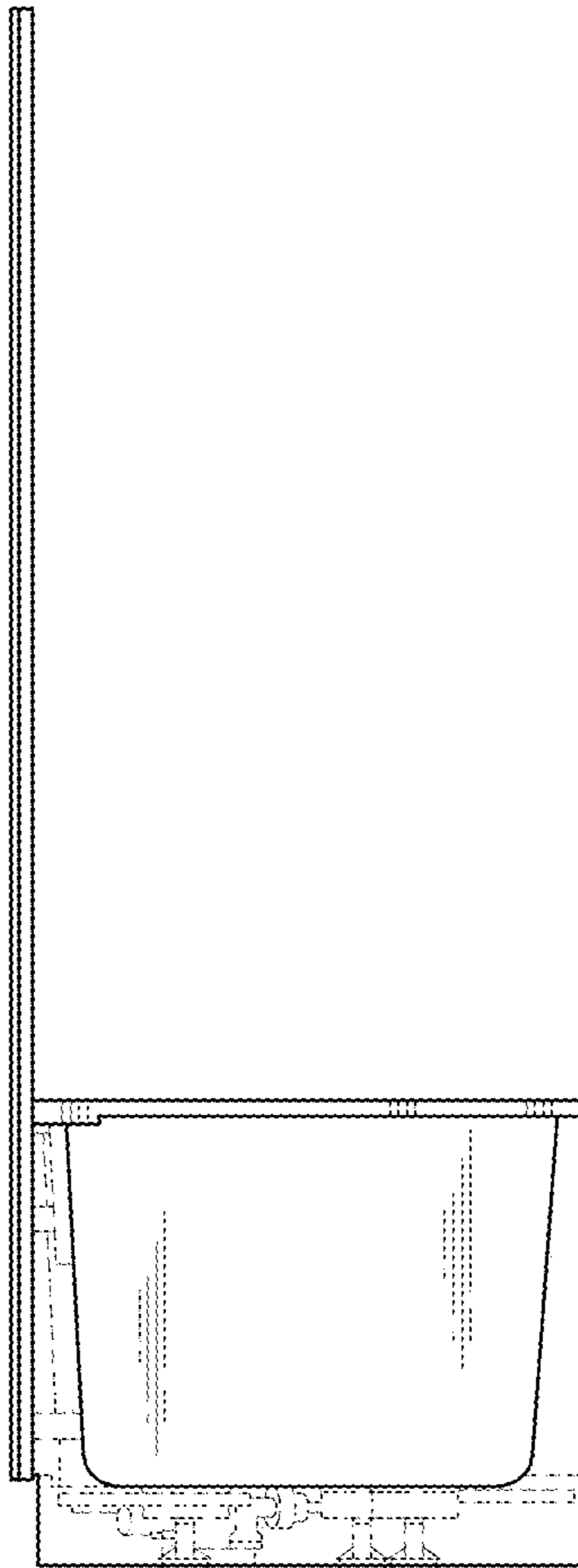

FIG. 16