

US00D895020S

(12) **United States Design Patent** (10) **Patent No.:** **US D895,020 S**
Legras et al. (45) **Date of Patent:** **** Sep. 1, 2020**

(54) **GAMING APPARATUS HAVING A CYLINDRICAL DISPLAY**

(71) Applicant: **IGT, Las Vegas, NV (US)**

(72) Inventors: **Jean-Pierre Legras, Carson City, NV (US); Charles Johnson, Reno, NV (US)**

(73) Assignee: **IGT, Las Vegas, NV (US)**

(**) Term: **15 Years**

(21) Appl. No.: **29/686,580**

(22) Filed: **Apr. 5, 2019**

(51) **LOC (12) Cl.** **21-03**

(52) **U.S. Cl.**
USPC **D21/369**

(58) **Field of Classification Search**
USPC D21/369, 370, 371, 385, 329, 325, 394, D21/375; D14/307, 172, 129, 325, 401, D14/371, 126, 439, 432, 450, 128, 375, D14/248, 374, 341, 138 G, 127; 463/28, 463/13, 11, 16, 20, 25, 31, 46, 23, 30, 17, 463/36, 29, 42, 34, 32, 35, 19, 21, 22; 273/292, 203, 138.2, 143 R, 142 R, 138.1; D19/60; D16/226; D8/335, 331, 334; D26/141; D7/641
CPC .. G07F 17/3211; G07F 17/32; G07F 17/3213; G07F 17/34; G07F 17/3267; G07F 17/3202; G07F 17/3262; G07F 17/3286; G07F 17/3272; G07F 17/3216; G07F 17/322; A63F 9/0406; A63F 5/045; A63F 3/00157; A63F 5/02
See application file for complete search history.

(56) **References Cited**

U.S. PATENT DOCUMENTS

1,445,891 A * 2/1923 Johnson A63F 5/043
273/141 R
1,578,412 A * 3/1926 Ewig A63F 1/04
273/142 E

D72,689 S * 5/1927 Auchter D21/813
1,670,692 A * 5/1928 Rosar A63F 5/00
273/142 F
2,036,718 A * 4/1936 Potter A63F 1/04
273/142 R
2,077,124 A * 4/1937 Miller A63F 5/043
273/142 HA
D163,281 S * 5/1951 Haupenthal D21/375
2,721,082 A * 10/1955 Hunold A63F 5/02
273/142 F
3,850,432 A * 11/1974 Crocker A63F 5/04
273/368
D250,215 S * 11/1978 Elliot 273/409

(Continued)

Primary Examiner — Ryan Harvey

(74) *Attorney, Agent, or Firm* — Neal, Gerber & Eisenberg LLP

(57) **CLAIM**

The ornamental design for a gaming apparatus having a cylindrical display, as shown and described herein.

DESCRIPTION

FIG. 1 is a front perspective view of a gaming apparatus having a cylindrical display of our new design.
FIG. 2 is a front view of the gaming apparatus having a cylindrical display of FIG. 1.
FIG. 3 is a rear view of the gaming apparatus having a cylindrical display of FIG. 1.
FIG. 4 is a right side view of the gaming apparatus having a cylindrical display of FIG. 1.
FIG. 5 is a left side view of the gaming apparatus having a cylindrical display of FIG. 1; and,
FIG. 6 is a top view of the gaming apparatus having a cylindrical display of FIG. 1.
The portions shown in phantom are not part of the claimed design.

1 Claim, 6 Drawing Sheets

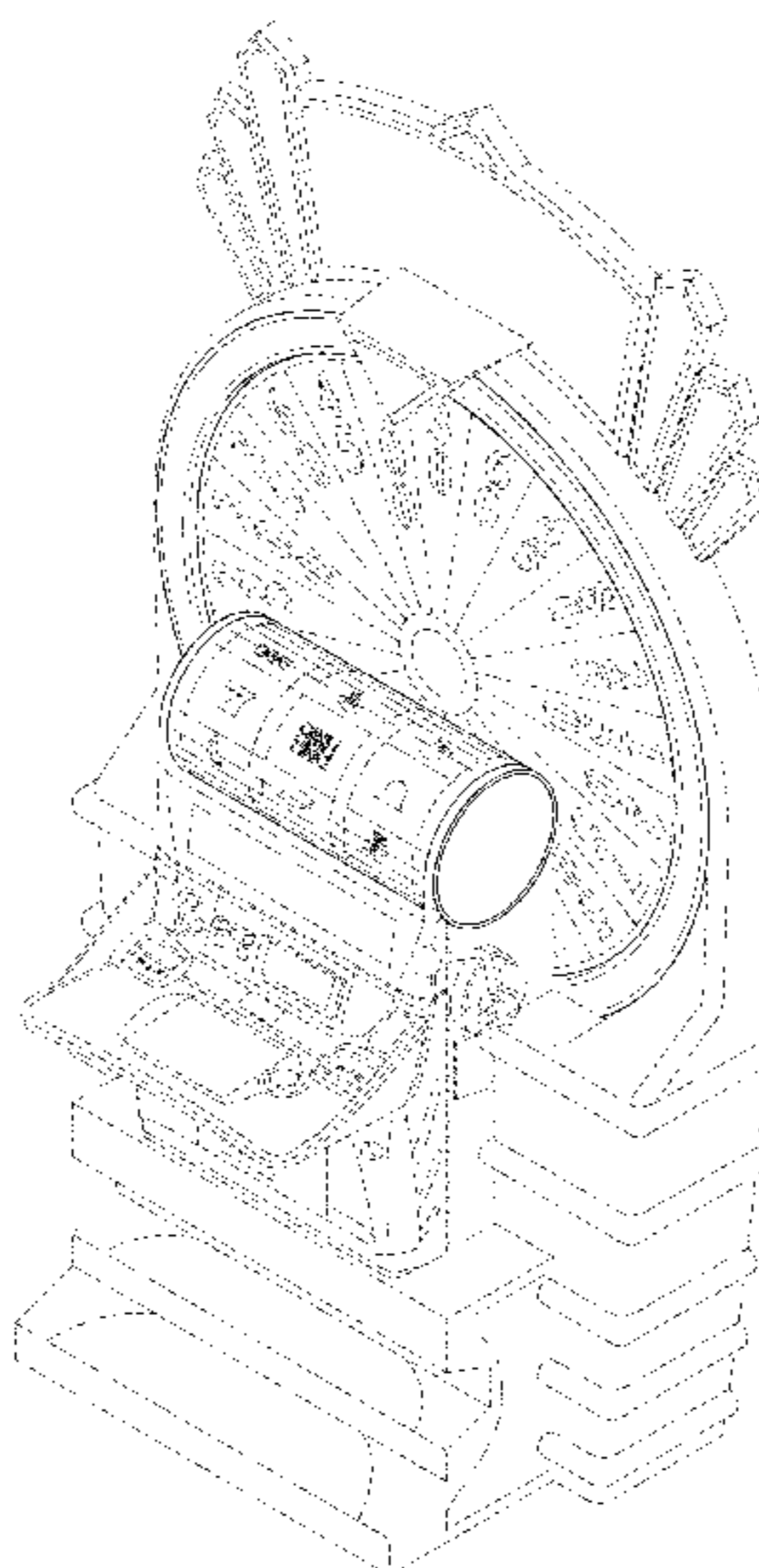

(56)

References Cited

U.S. PATENT DOCUMENTS

D251,395 S *	3/1979	Kula	D21/327	D612,892 S *	3/2010	Miele	D21/308
D270,362 S *	8/1983	de Gregorio	D21/375	7,862,422 B2 *	1/2011	Garamendi	G07F 17/34 463/20
D340,478 S *	10/1993	Erskine	D21/308	7,942,417 B2 *	5/2011	Smith	G07F 17/34 273/138.2
D345,585 S *	3/1994	Nelly	D21/375	8,100,754 B2 *	1/2012	Bigelow, Jr.	G07F 17/34 463/16
D369,850 S *	5/1996	Cammack	D23/209	8,216,046 B2 *	7/2012	Ikeya	G07F 17/32 463/16
D376,825 S *	12/1996	Hanscom	D21/324	8,246,445 B2 *	8/2012	Rodgers	G07F 17/32 463/16
D393,012 S *	3/1998	Burns	D21/307	8,328,632 B2 *	12/2012	Cannon	G07F 17/42 463/17
5,743,523 A *	4/1998	Kelly	A63F 7/0058 273/118 A	8,419,526 B1 *	4/2013	Cannon	G07F 17/32 463/25
5,755,619 A *	5/1998	Matsumoto	A63F 3/062 273/269	8,444,477 B2	5/2013	Inoue	
D397,161 S *	8/1998	Hanscom	D21/369	D690,773 S *	10/2013	Miller	D21/370
D400,235 S *	10/1998	Jukes	D21/329	D696,355 S *	12/2013	MacDonald	D21/375
5,879,235 A *	3/1999	Kaneko	A63F 5/0005 273/142 R	8,808,094 B2 *	8/2014	DeSimone	G07F 17/3216 463/30
5,947,472 A *	9/1999	Tang	A63F 3/00157 273/142 R	D714,392 S *	9/2014	Arabian	D21/369
6,224,483 B1 *	5/2001	Mayeroff	G07F 17/32 463/16	D722,345 S *	2/2015	Sirmakes	D21/375
D460,120 S *	7/2002	Lynch	D21/325	8,956,216 B1 *	2/2015	LeSourd	G07F 17/3213 463/20
D486,869 S *	2/2004	Webb	D21/370	D729,321 S *	5/2015	Arabian	D21/369
D491,231 S *	6/2004	Tournillon	D21/308	9,027,927 B2	5/2015	Smith	
D491,232 S *	6/2004	Tournillon	D21/308	D760,322 S *	6/2016	Shaw	D21/307
D504,473 S *	4/2005	Baerlocher	D21/370	D793,498 S *	8/2017	Manus	D21/699
D511,549 S *	11/2005	Kaminkow	D21/370	9,728,031 B2 *	8/2017	Schultz	G07F 17/3272
D512,465 S *	12/2005	Karstens	D21/370	D803,325 S *	11/2017	Lipovec	D21/375
D514,168 S *	1/2006	Kaminkow	D21/369	9,849,367 B2 *	12/2017	Jones	A63F 1/12
D514,170 S *	1/2006	Kaminkow	D21/370	9,999,830 B2 *	6/2018	Fisher	A63F 5/02
D520,071 S *	5/2006	Seelig	D21/370	D843,469 S *	3/2019	Nettenstrom	D21/369
D520,072 S *	5/2006	Seelig	D21/370	D847,299 S *	4/2019	Thompson	D23/200
D523,093 S *	6/2006	Kaminkow	D21/324	D876,186 S *	2/2020	Marantis	D7/700
D523,908 S *	6/2006	Hedrick et al.		D880,597 S *	4/2020	Mei	D21/308
D524,380 S *	7/2006	Seelig	D21/370	D880,605 S *	4/2020	Bussey	D21/369
D529,965 S *	10/2006	Hedrick et al.		2003/0027628 A1 *	2/2003	Luciano	G07F 17/32 463/20
D532,831 S *	11/2006	Baerlocher	D21/385	2003/0148804 A1 *	8/2003	Ikeya	G07F 17/3211 463/16
7,153,209 B2	12/2006	Rothkranz et al.		2003/0153385 A1 *	8/2003	Ikeya	G07F 17/34 463/31
D534,590 S *	1/2007	Kaminkow	D21/369	2004/0048645 A1 *	3/2004	Webb	G07F 17/3202 463/16
D536,386 S *	2/2007	Kaminkow	D21/324	2005/0192090 A1 *	9/2005	Muir	G07F 17/3211 463/30
D536,387 S *	2/2007	Kaminkow	D21/324	2006/0046821 A1 *	3/2006	Kaminkow	G07F 17/326 463/16
D536,388 S *	2/2007	Kaminkow	D21/369	2008/0146331 A1 *	6/2008	Nordman	G07F 17/32 463/31
D536,743 S *	2/2007	Kaminkow	D21/369	2008/0227530 A1 *	9/2008	LeMay	G07F 17/3211 463/22
D537,127 S *	2/2007	Kaminkow	D21/370	2012/0115563 A1 *	5/2012	Kido	G07F 17/3262 463/17
D537,886 S *	3/2007	Kaminkow	D21/369	2012/0122545 A1 *	5/2012	Watkins	G07F 17/3211 463/20
D548,288 S *	8/2007	Baerlocher	D21/369				
D548,800 S *	8/2007	Kaminkow	D21/329				
7,278,638 B2	10/2007	Nordman					
D558,835 S *	1/2008	Zielinski	D21/370				
7,335,103 B2	2/2008	Seelig et al.					
D569,919 S *	5/2008	Zielinski	D21/370				
7,371,172 B2	5/2008	Inoue					
D572,770 S *	7/2008	Seelig	D21/370				
7,461,842 B2 *	12/2008	Wu	A63F 5/045 273/138.1				
D590,025 S *	4/2009	Fiore	D21/370				
D591,360 S *	4/2009	Fiore	D21/370				
7,614,950 B2	11/2009	Rothkranz					

* cited by examiner

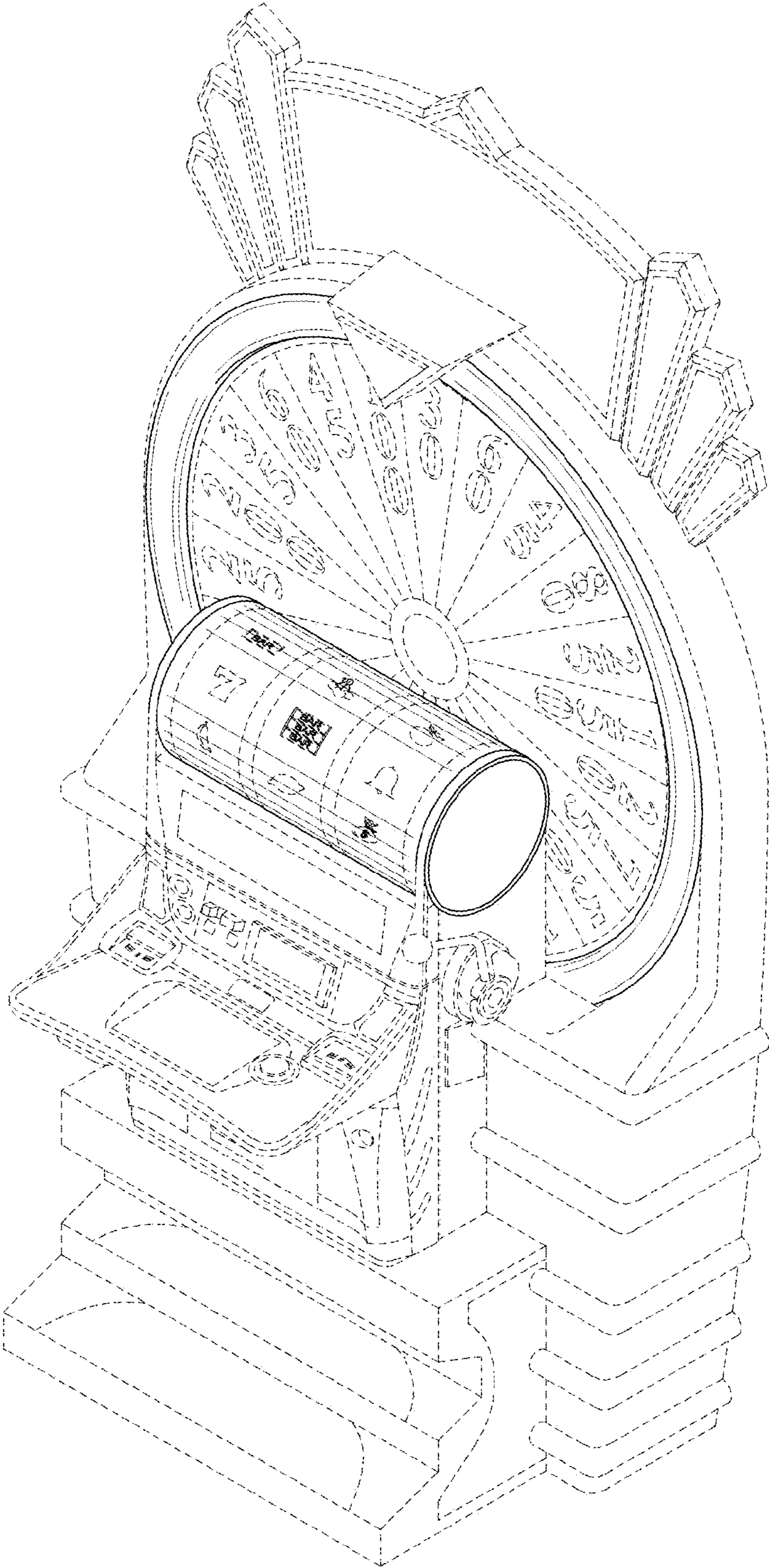

FIG. 1

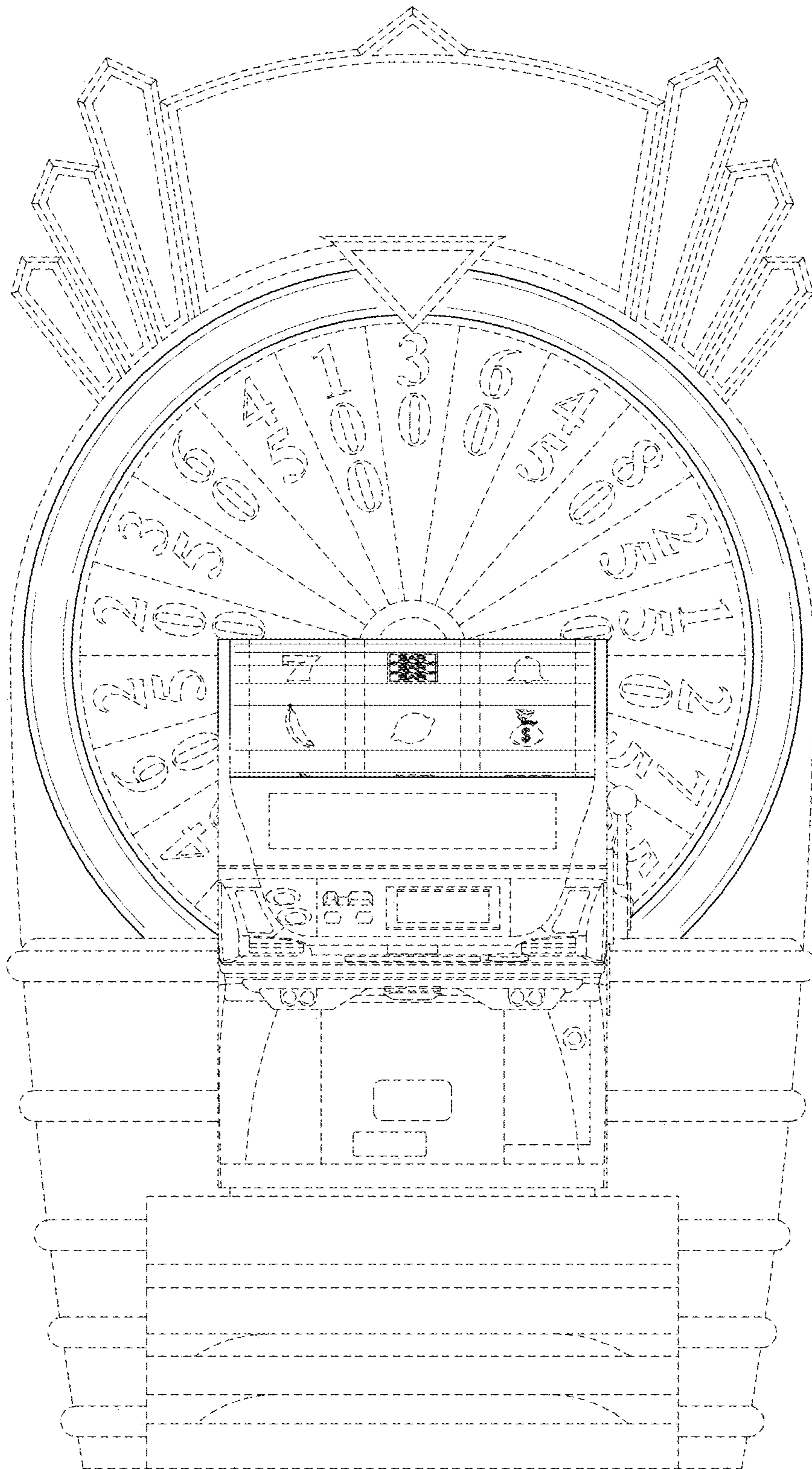

FIG. 2

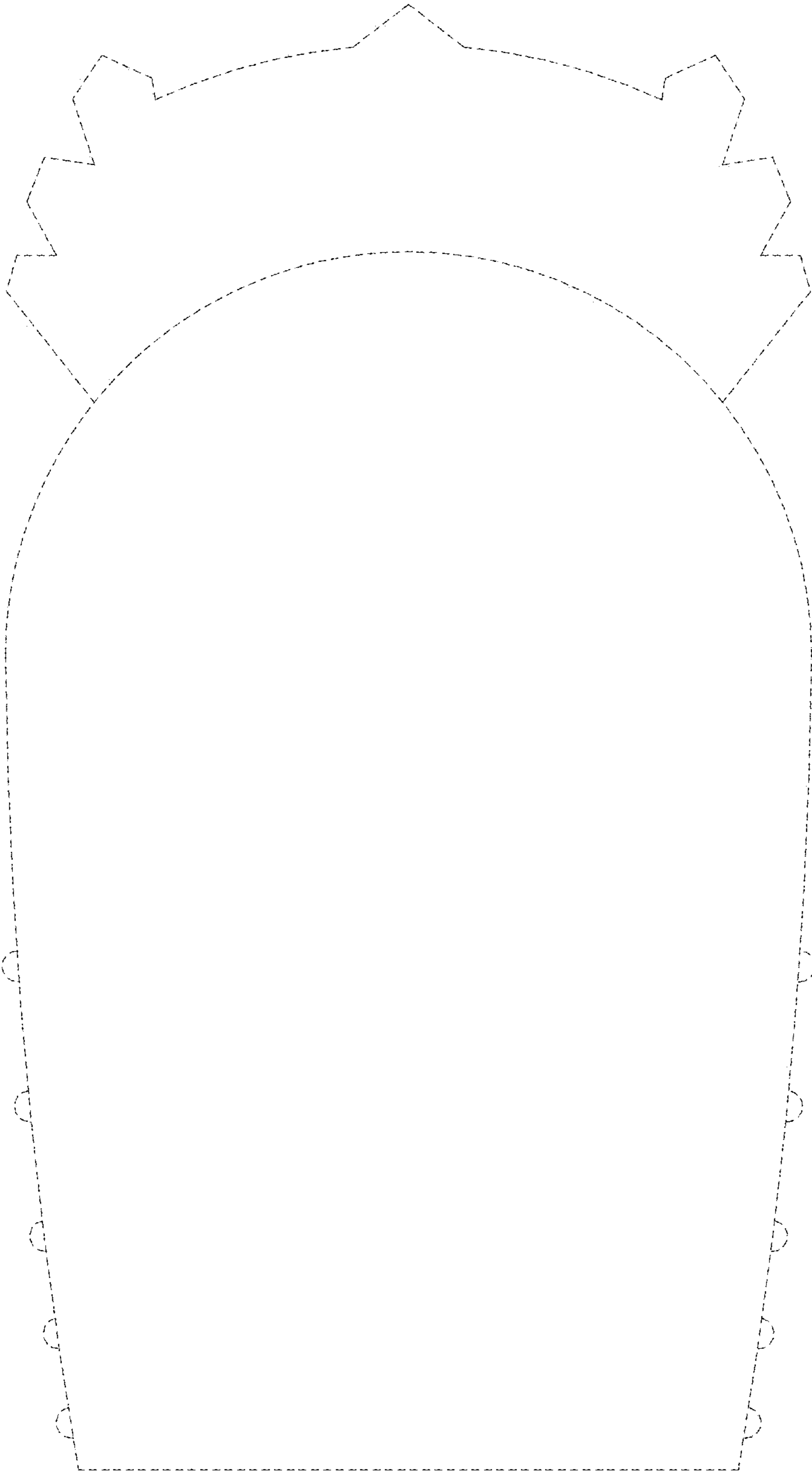

FIG. 3

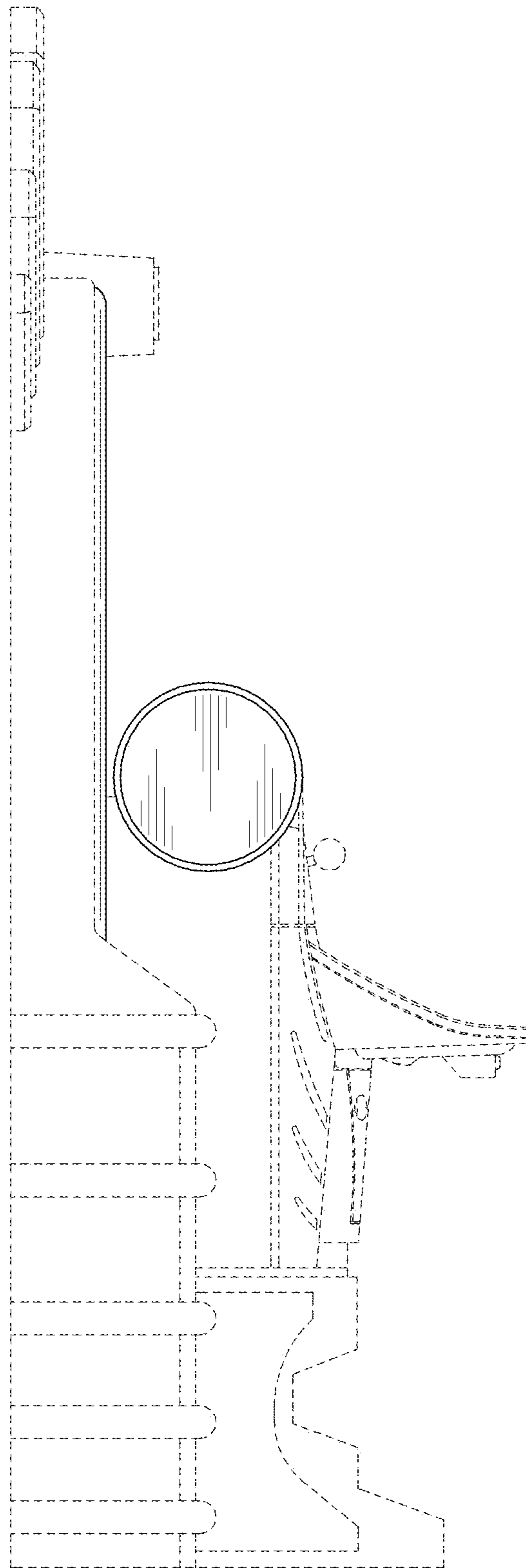

FIG. 4

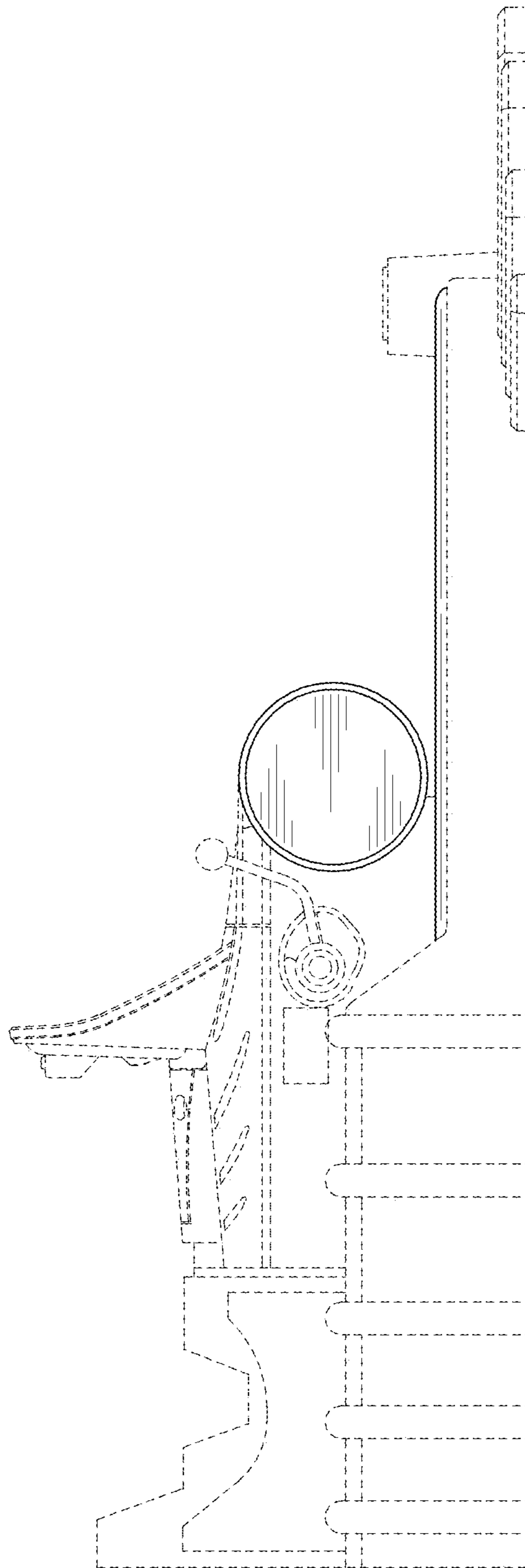

FIG. 5

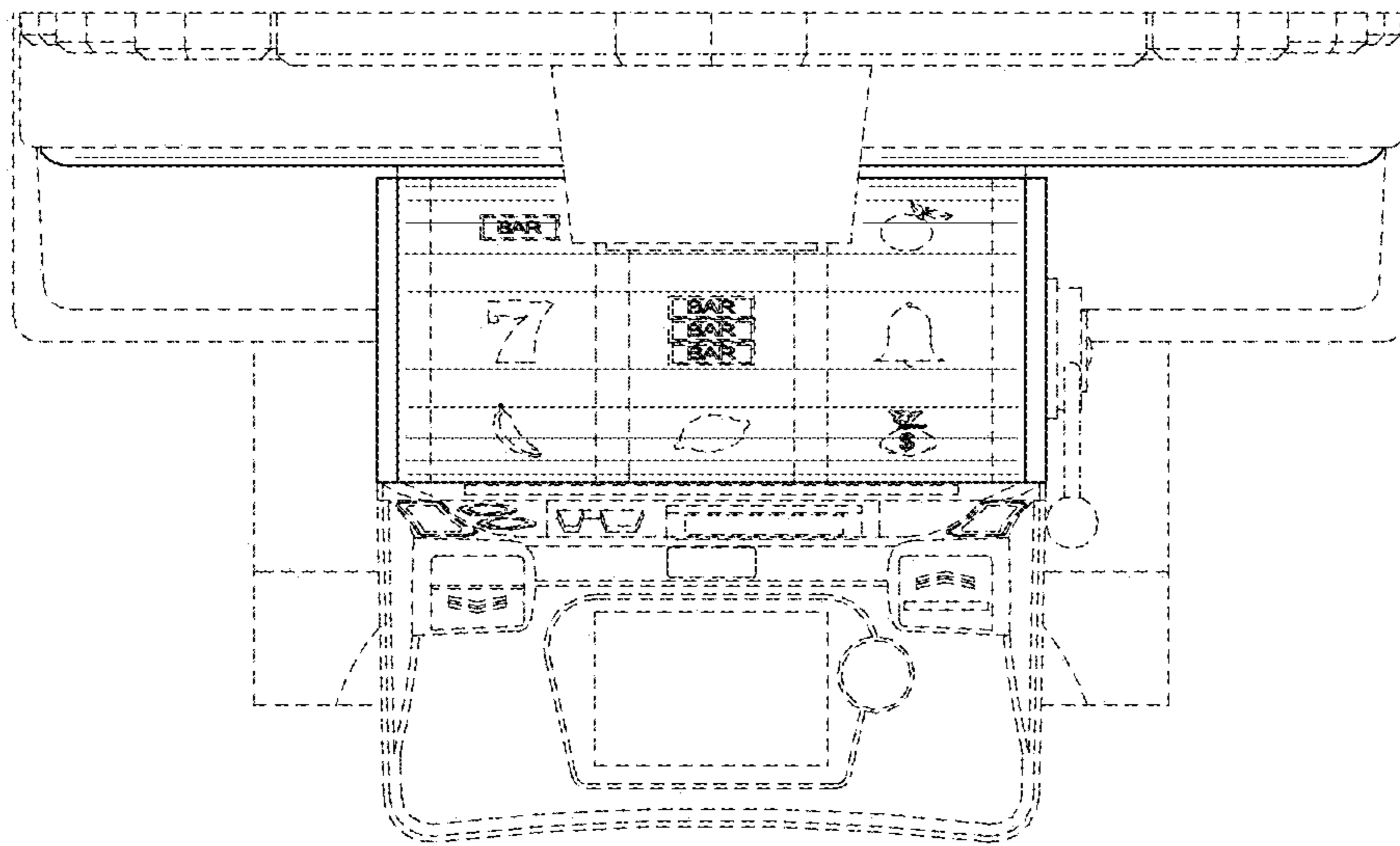

FIG. 6