

US00D894837S

(12) **United States Design Patent** (10) **Patent No.:** **US D894,837 S**  
**Chen** (45) **Date of Patent:** **\*\* Sep. 1, 2020**

(54) **SOCKET**  
(71) Applicant: **SHENZHEN ANHAORUIHE ELECTRONICS CO., LTD**, Shenzhen (CN)  
(72) Inventor: **Xinhe Chen**, Shenzhen (CN)  
(73) Assignee: **SHENZHEN ANHAORUIHE ELECTRONICS CO., LTD**, Shenzhen (CN)

D848,948 S \* 5/2019 Wei ..... D13/137.2  
D851,597 S 6/2019 Ding  
D851,598 S \* 6/2019 Liang ..... D13/137.2  
D852,138 S 6/2019 Wen et al.  
D852,139 S 6/2019 Wen et al.  
D861,613 S \* 10/2019 Dai ..... D13/137.2  
D867,996 S \* 11/2019 Chen ..... D13/137.2  
D869,398 S \* 12/2019 Wang ..... D13/137.3  
D872,695 S \* 1/2020 Bo ..... D13/137.2  
D874,401 S \* 2/2020 Zhong ..... D13/110  
D886,064 S \* 6/2020 Chen ..... D13/139.8

\* cited by examiner

(\*\*) Term: **15 Years**

*Primary Examiner* — Rhea Shields

(21) Appl. No.: **29/734,481**

(57) **CLAIM**

The ornamental design for a socket, as shown and described.

(22) Filed: **May 13, 2020**

(51) **LOC (12) Cl.** ..... **13-03**

(52) **U.S. Cl.**  
USPC ..... **D13/139.7**

(58) **Field of Classification Search**  
USPC ..... D13/139.1–139.8, 137.1–137.4, 110  
CPC ..... H01R 35/04; H01R 31/06; H01R 31/065  
See application file for complete search history.

**DESCRIPTION**

(56) **References Cited**

U.S. PATENT DOCUMENTS

D651,974 S \* 1/2012 Benedetti ..... D13/137.2  
8,142,199 B1 \* 3/2012 Almouli ..... H01R 35/04  
439/10  
8,465,307 B2 \* 6/2013 Shieh ..... H01R 31/06  
439/173  
8,469,730 B2 \* 6/2013 Garb ..... H01R 31/065  
439/173  
D700,579 S \* 3/2014 Mobbs ..... D13/137.1  
D807,298 S \* 1/2018 Xu ..... D13/139.8  
D807,831 S \* 1/2018 Xu ..... D13/139.8  
D814,420 S \* 4/2018 Chen ..... D13/137.2  
D826,163 S \* 8/2018 Xu ..... D13/139.8  
D843,943 S \* 3/2019 Yang ..... D13/137.2  
D845,900 S \* 4/2019 Liu ..... D13/137.2

FIG. 1 is a perspective view of a first embodiment of a socket showing my new design;  
FIG. 2 is another perspective view thereof;  
FIG. 3 is a front elevational view thereof;  
FIG. 4 is a rear elevational view thereof;  
FIG. 5 is a left side elevational view thereof;  
FIG. 6 is a right side elevational view thereof;  
FIG. 7 is a top plan view thereof;  
FIG. 8 is a bottom plan view thereof;  
FIG. 9 is a perspective view of a second embodiment of the socket showing my new design;  
FIG. 10 is another perspective view thereof;  
FIG. 11 is a front elevational view thereof;  
FIG. 12 is a rear elevational view thereof;  
FIG. 13 is a left side elevational view thereof;  
FIG. 14 is a right side elevational view thereof;  
FIG. 15 is a top plan view thereof; and,  
FIG. 16 is a bottom plan view thereof.  
The broken lines in the drawings depict portions of the socket that form no part of the claimed design.

**1 Claim, 16 Drawing Sheets**

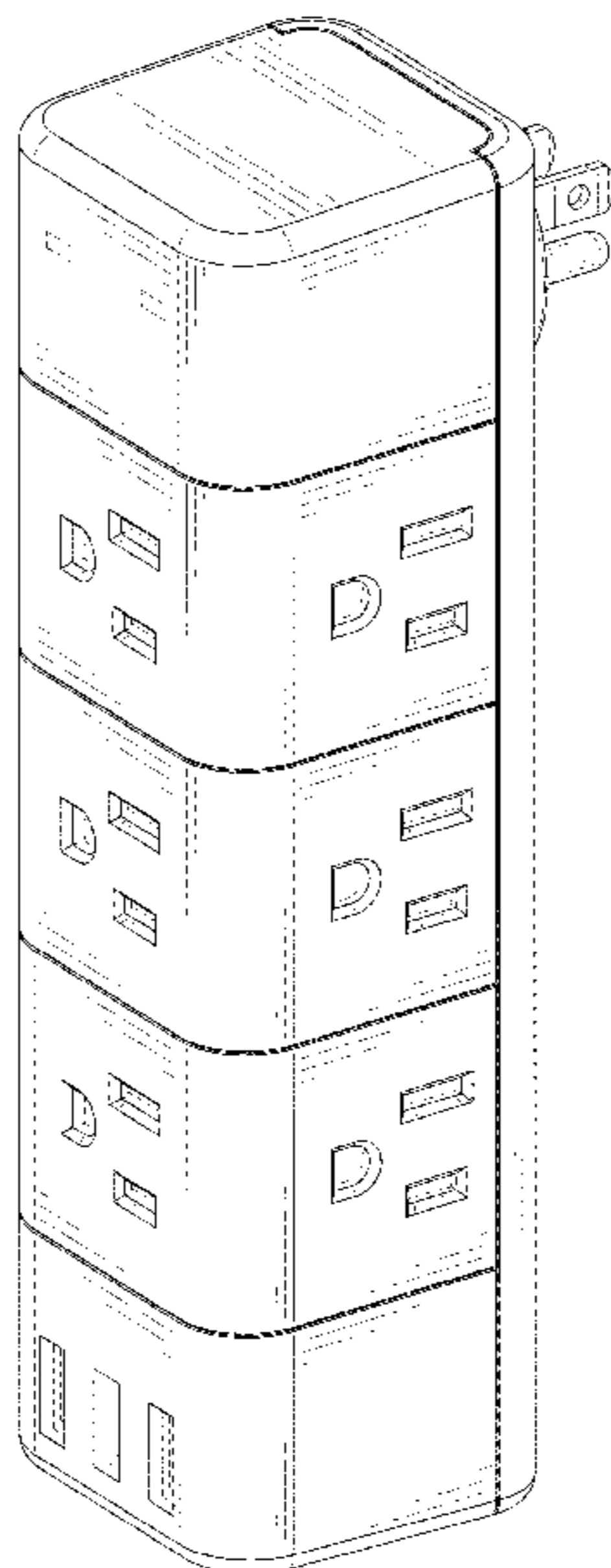

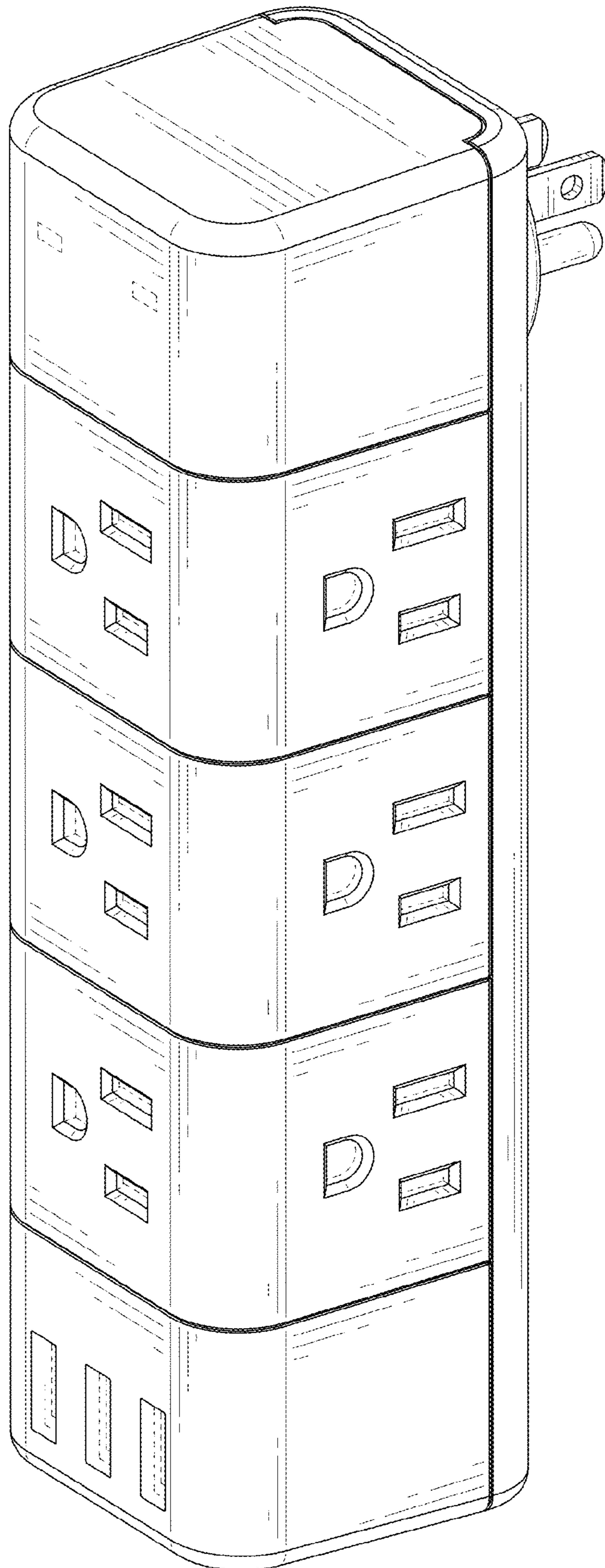

FIG. 1

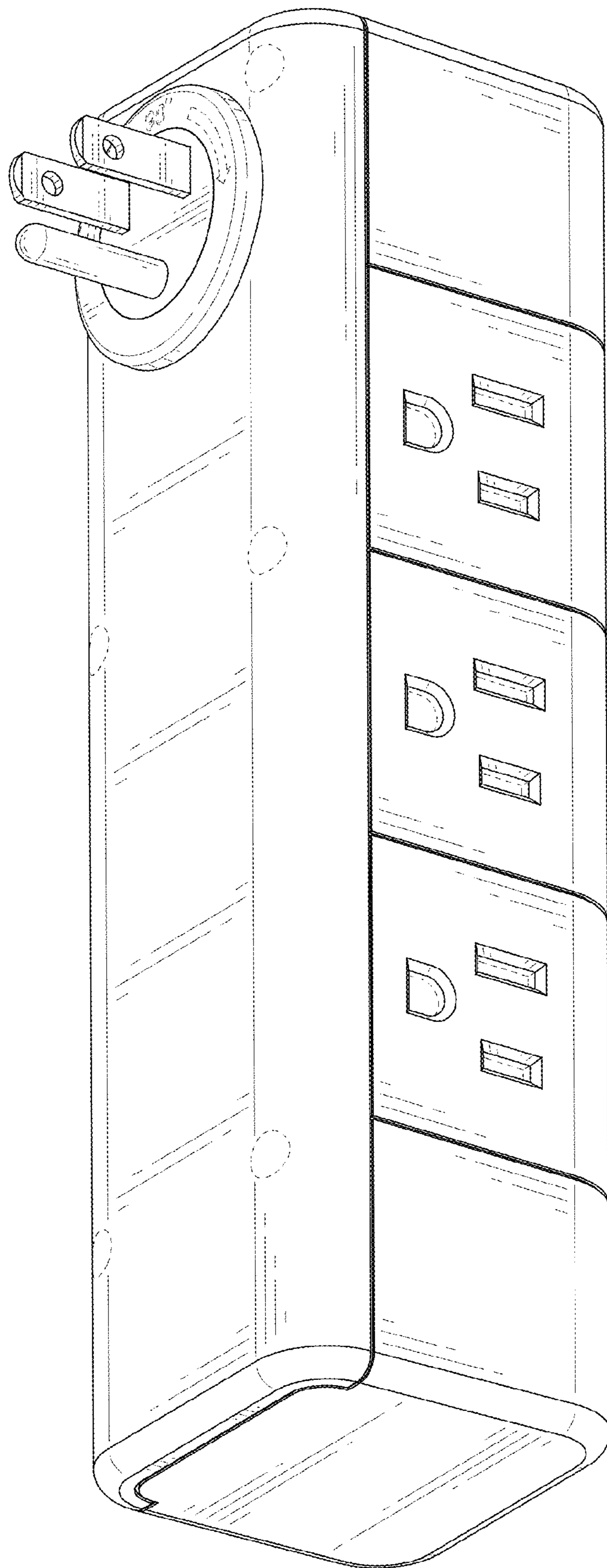

FIG. 2

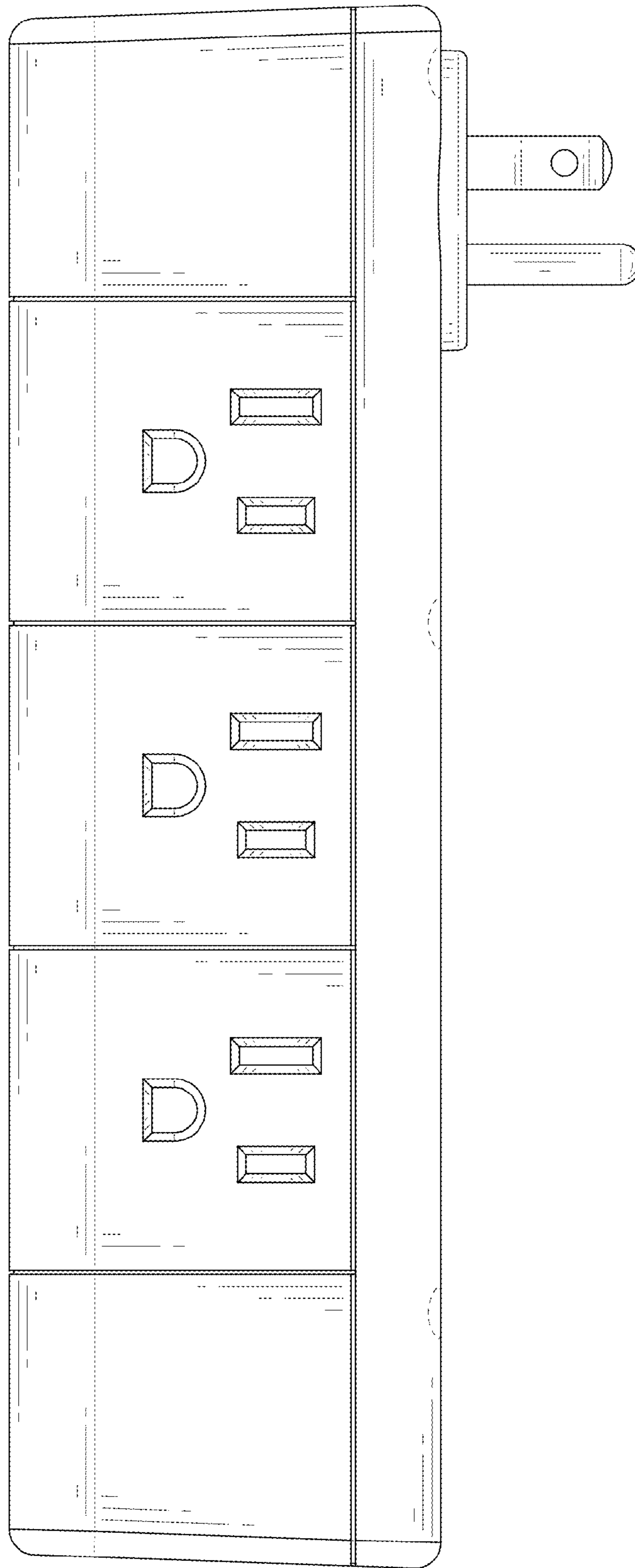

FIG. 3

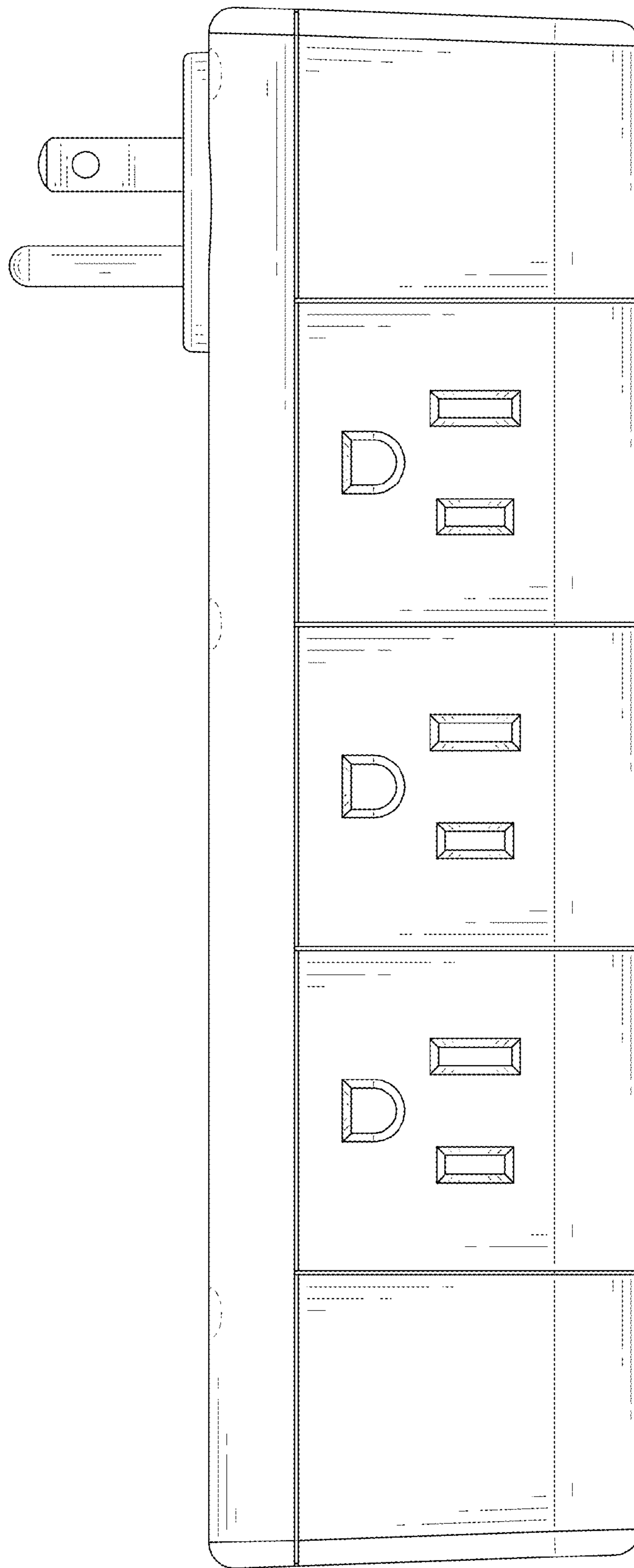

FIG. 4

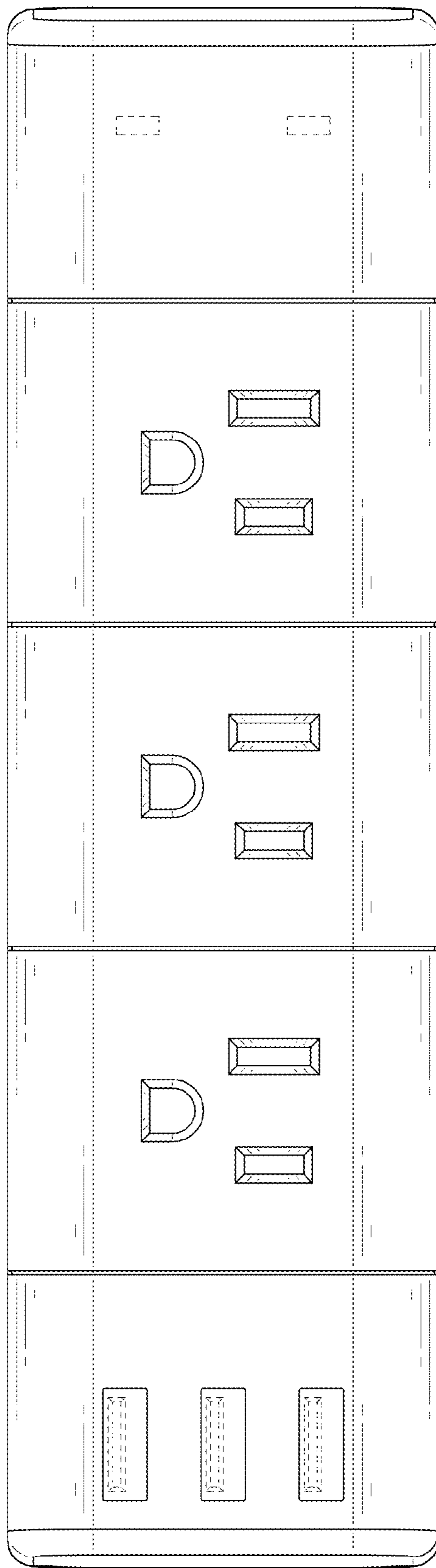

FIG. 5

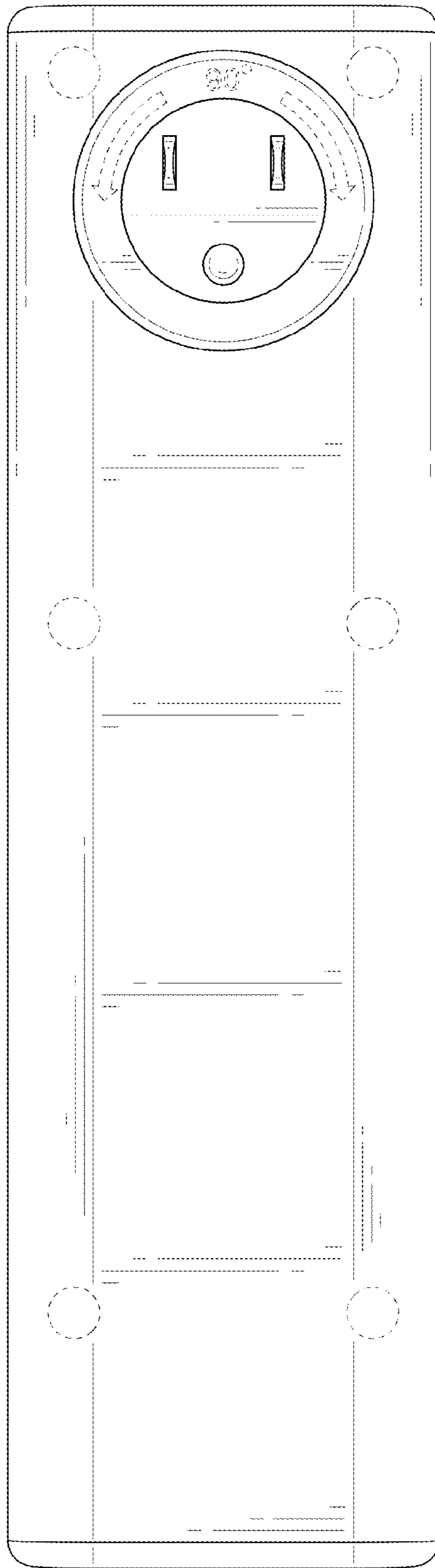

FIG. 6

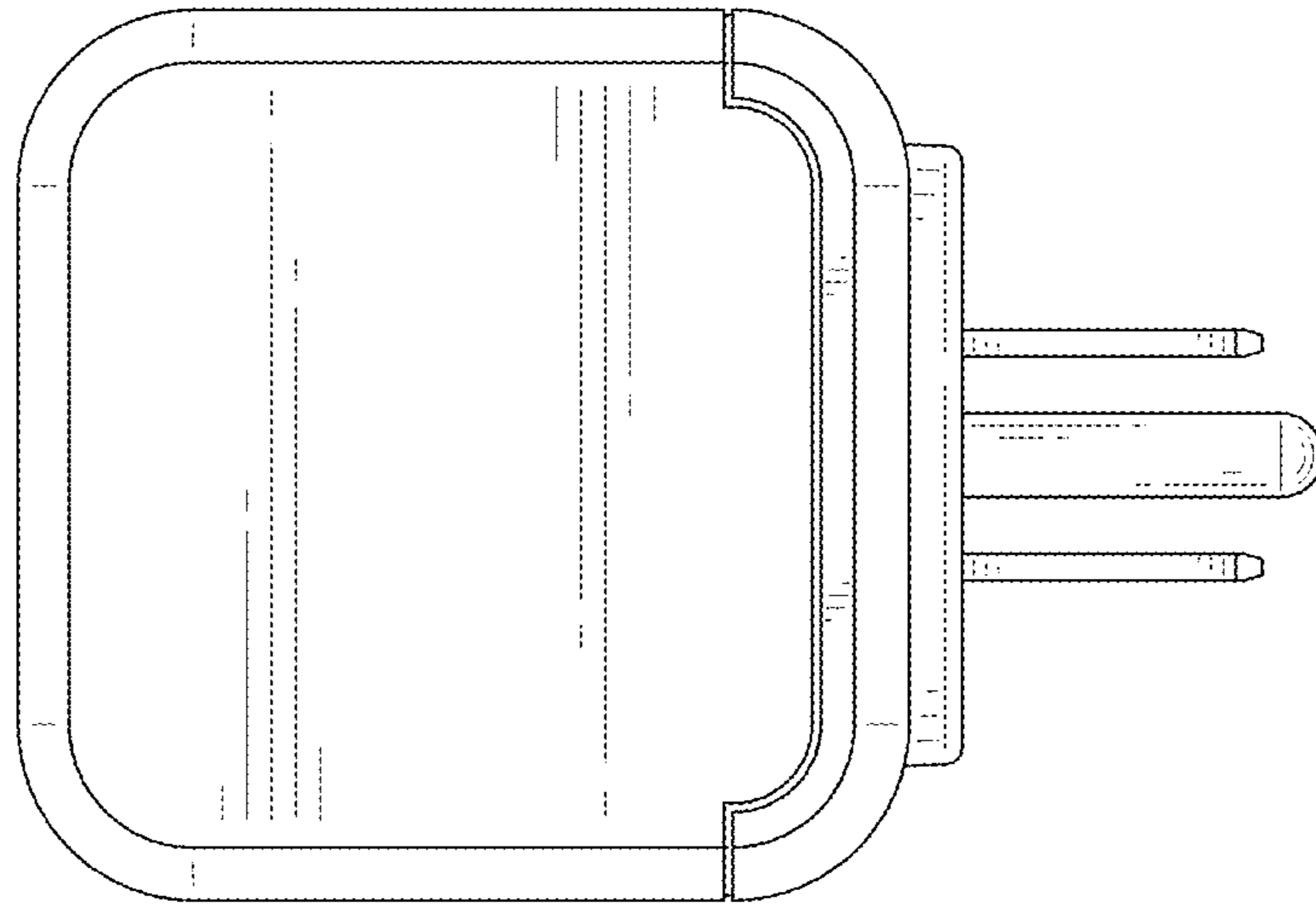

FIG. 7



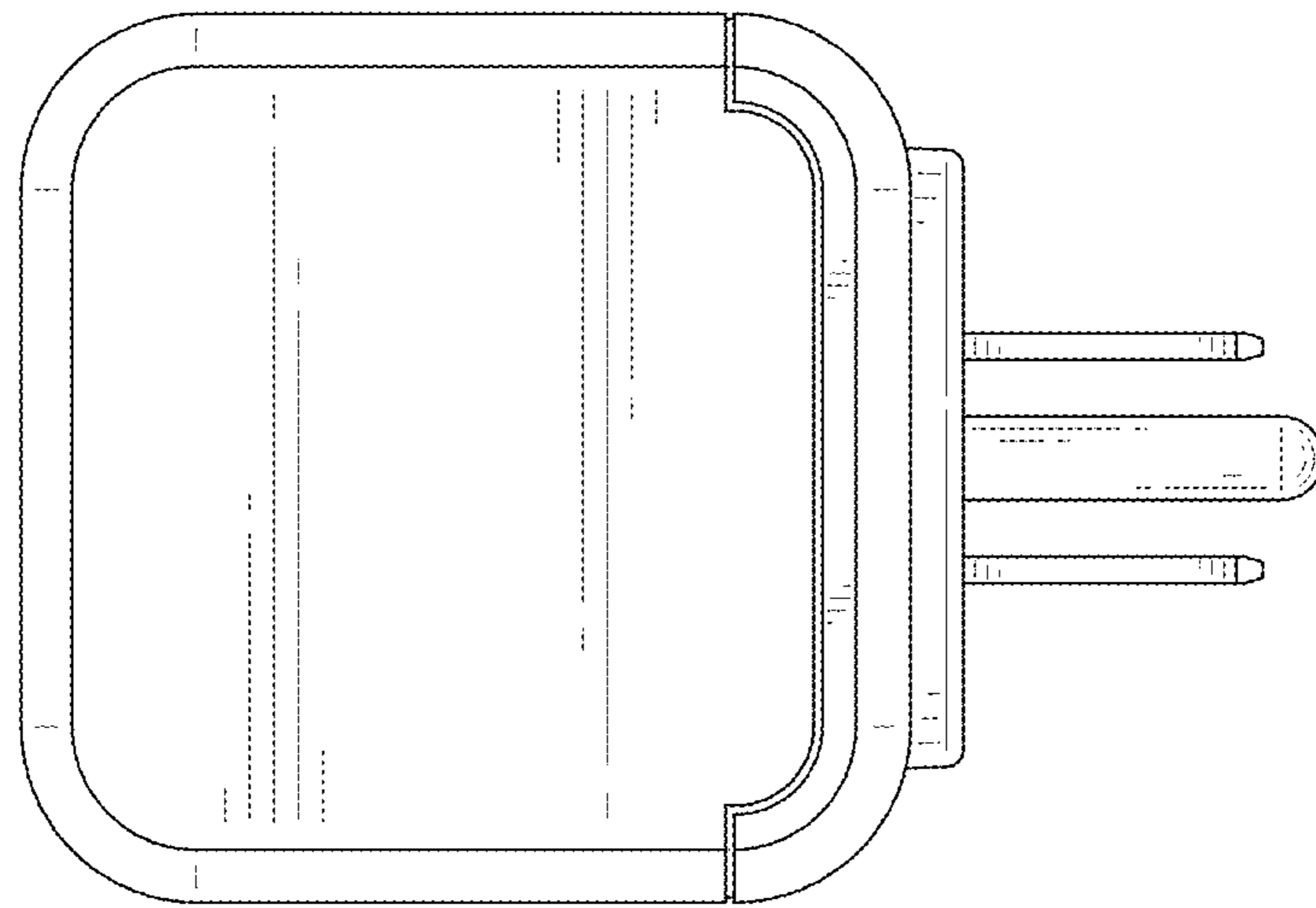

FIG. 8

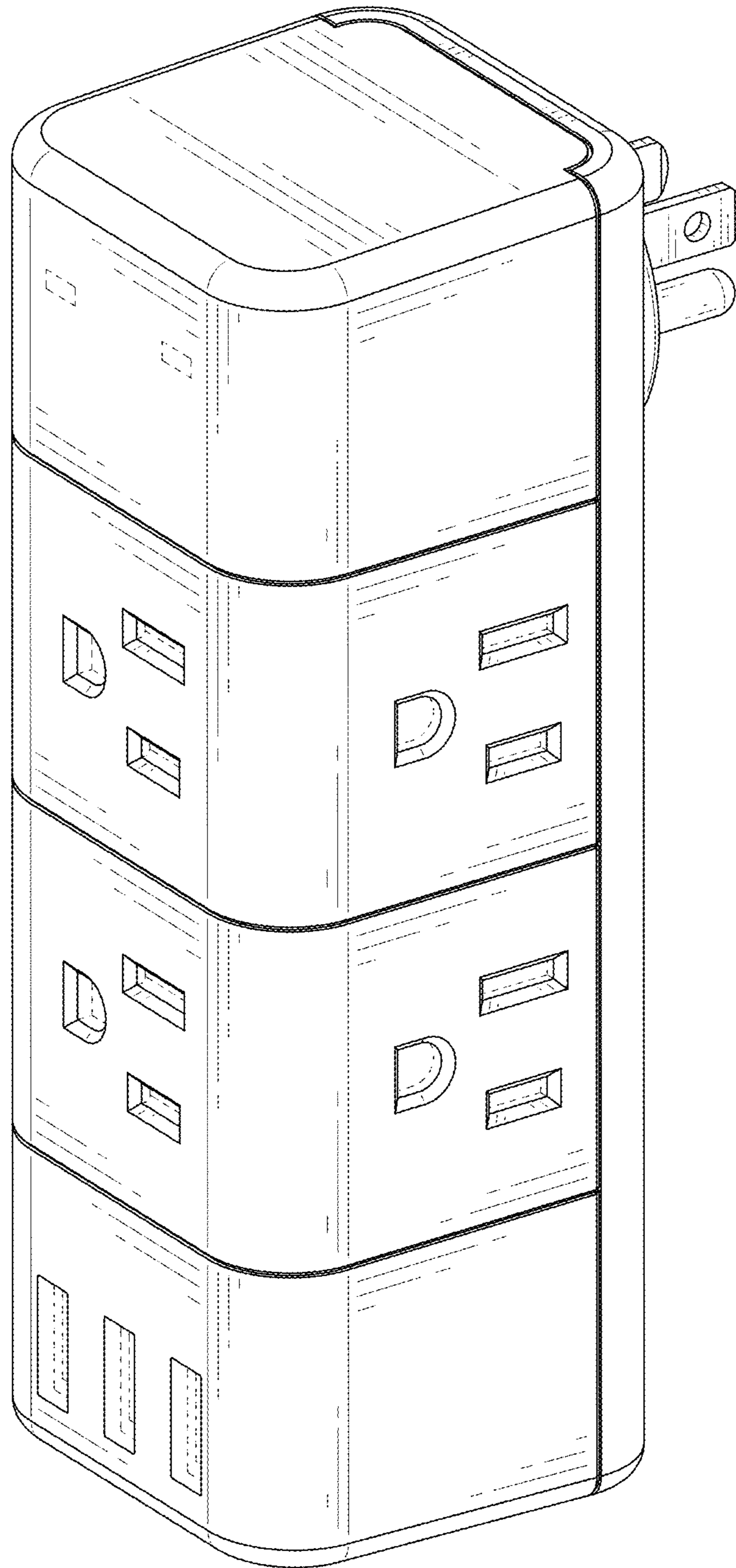

FIG. 9

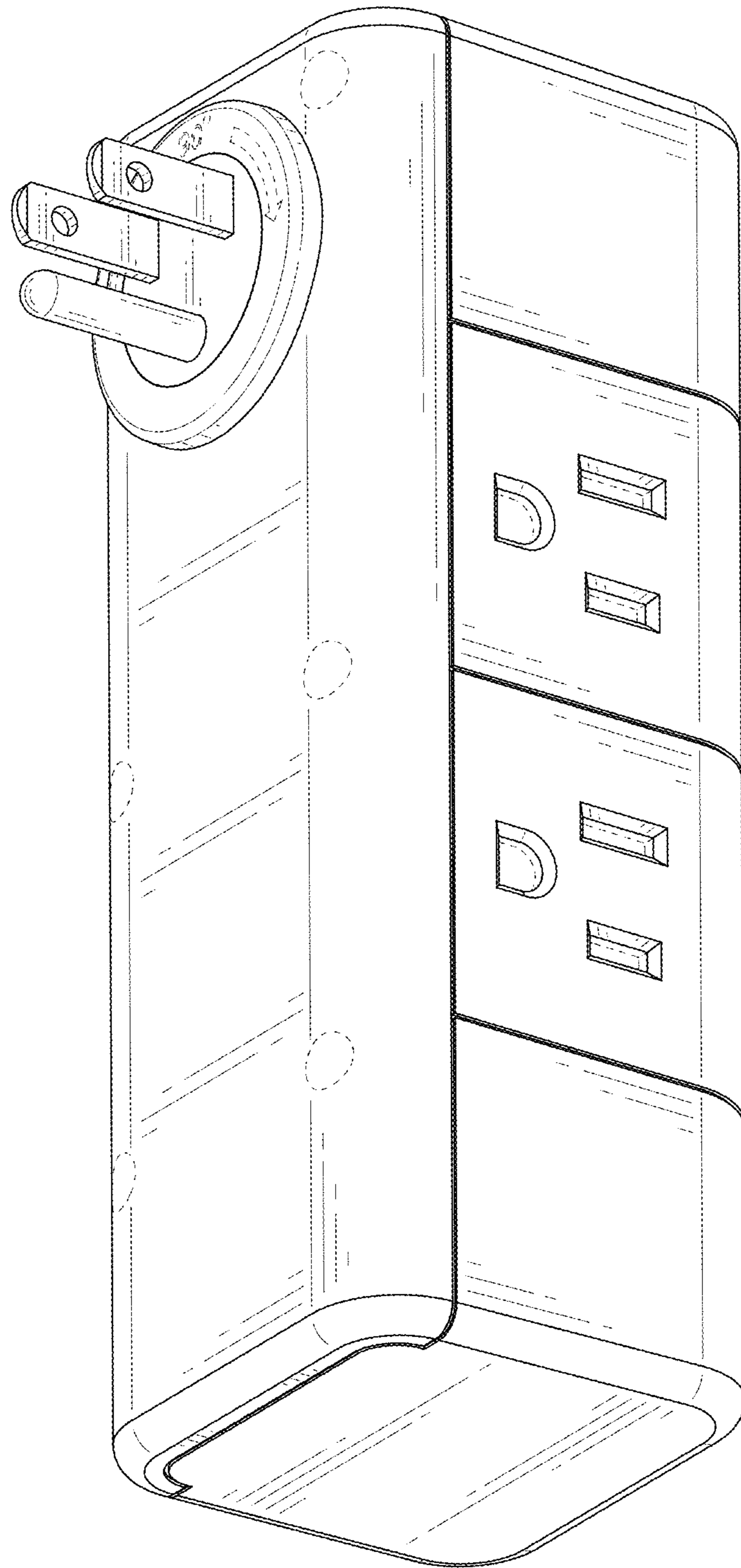

FIG. 10

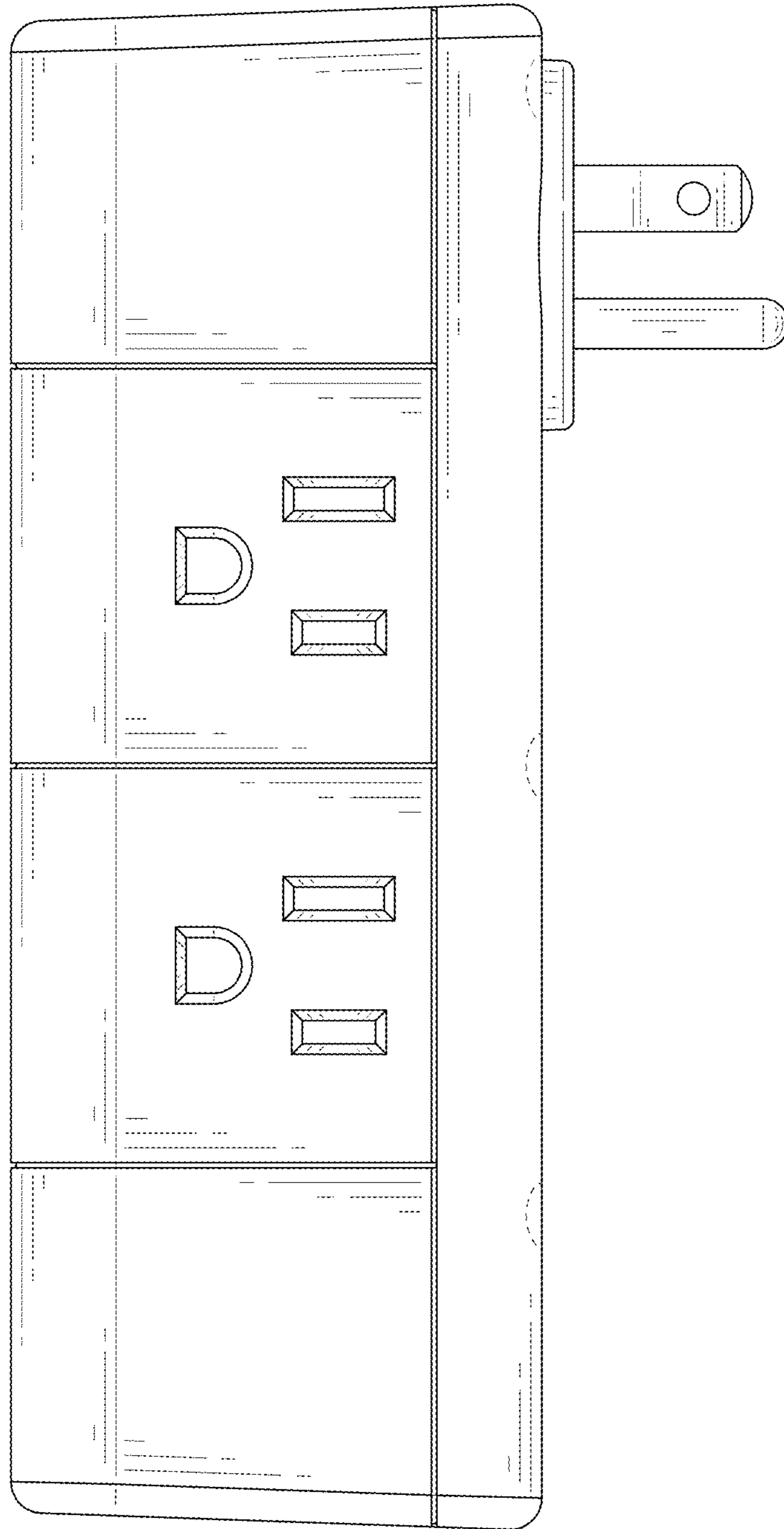

FIG. 11



FIG. 12

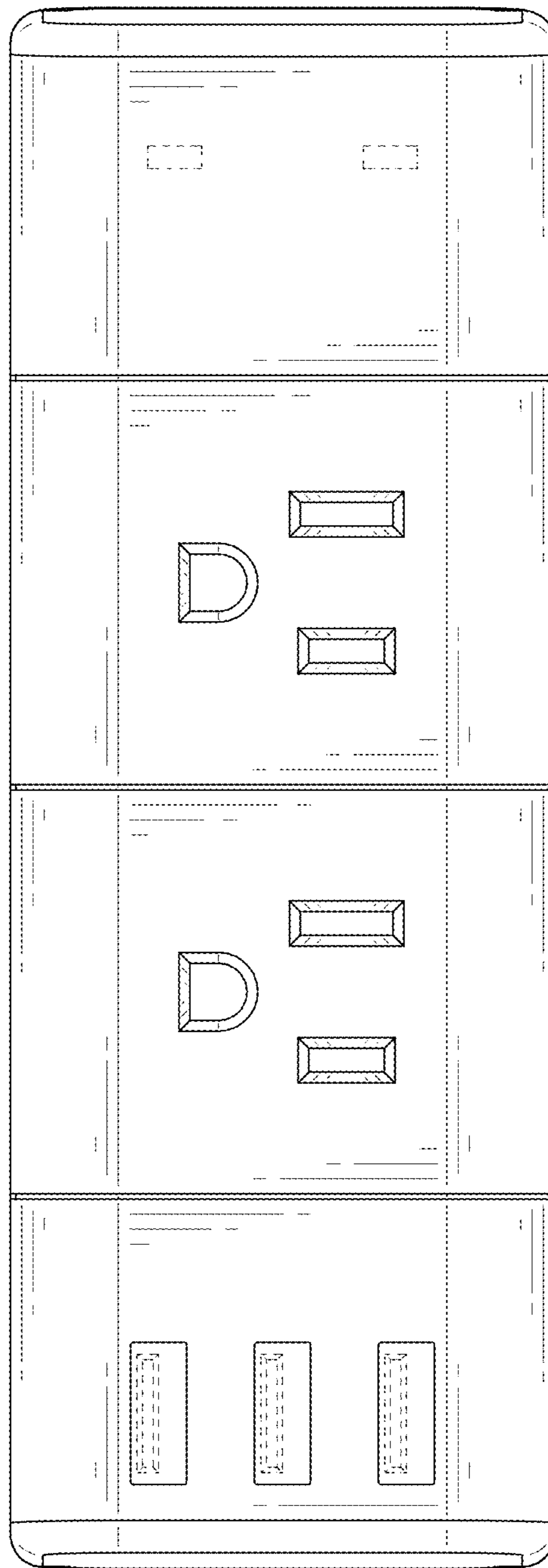

FIG. 13

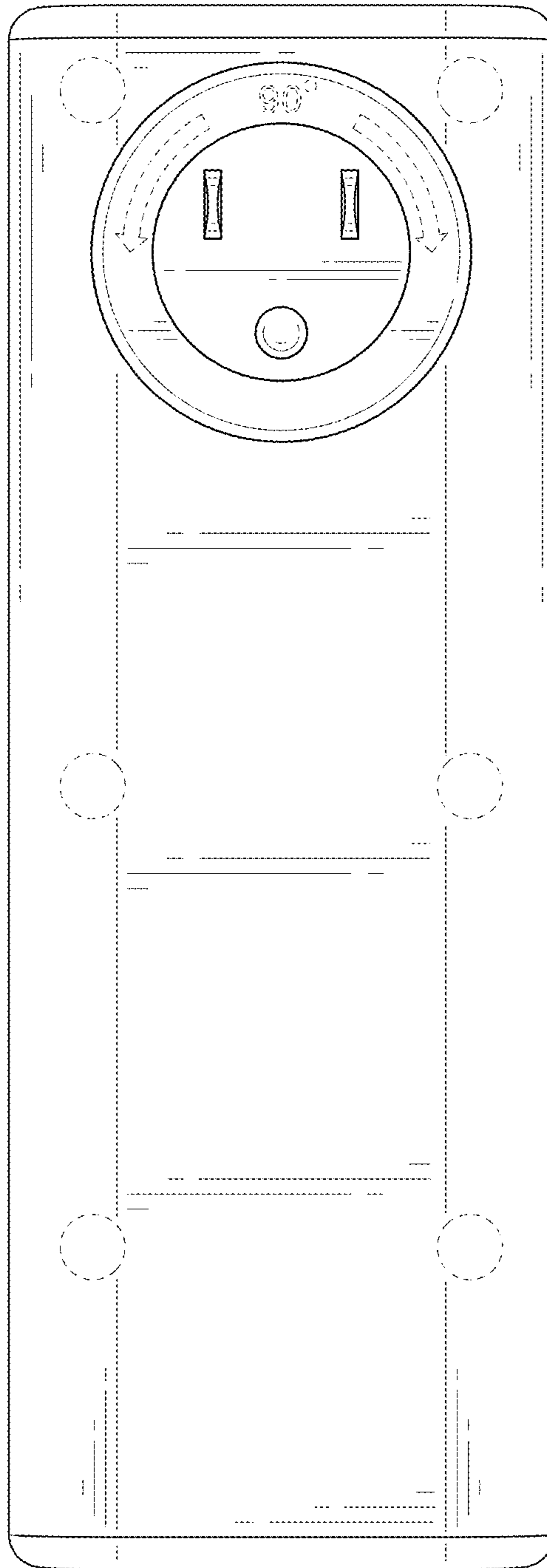

FIG. 14

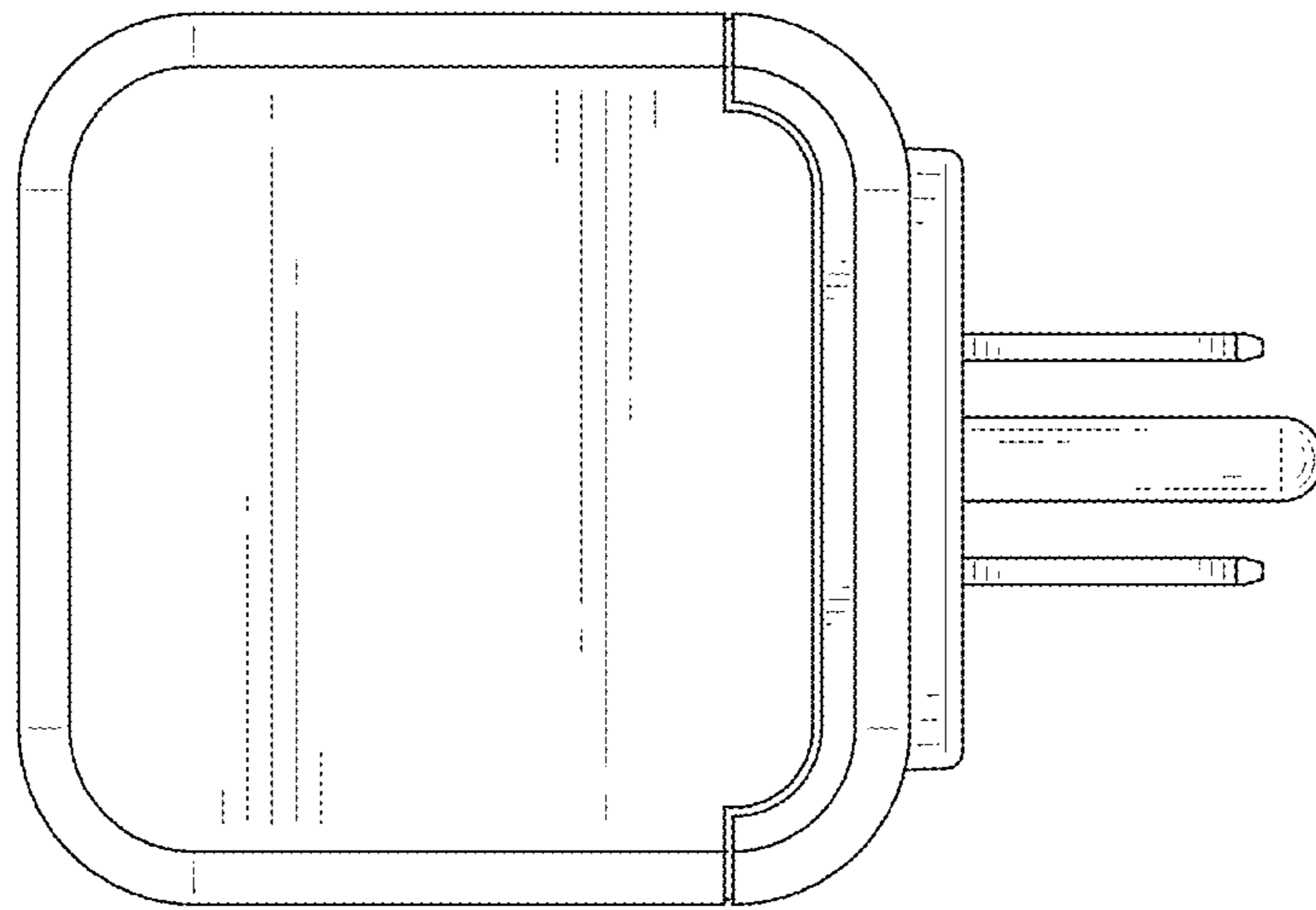

FIG. 15



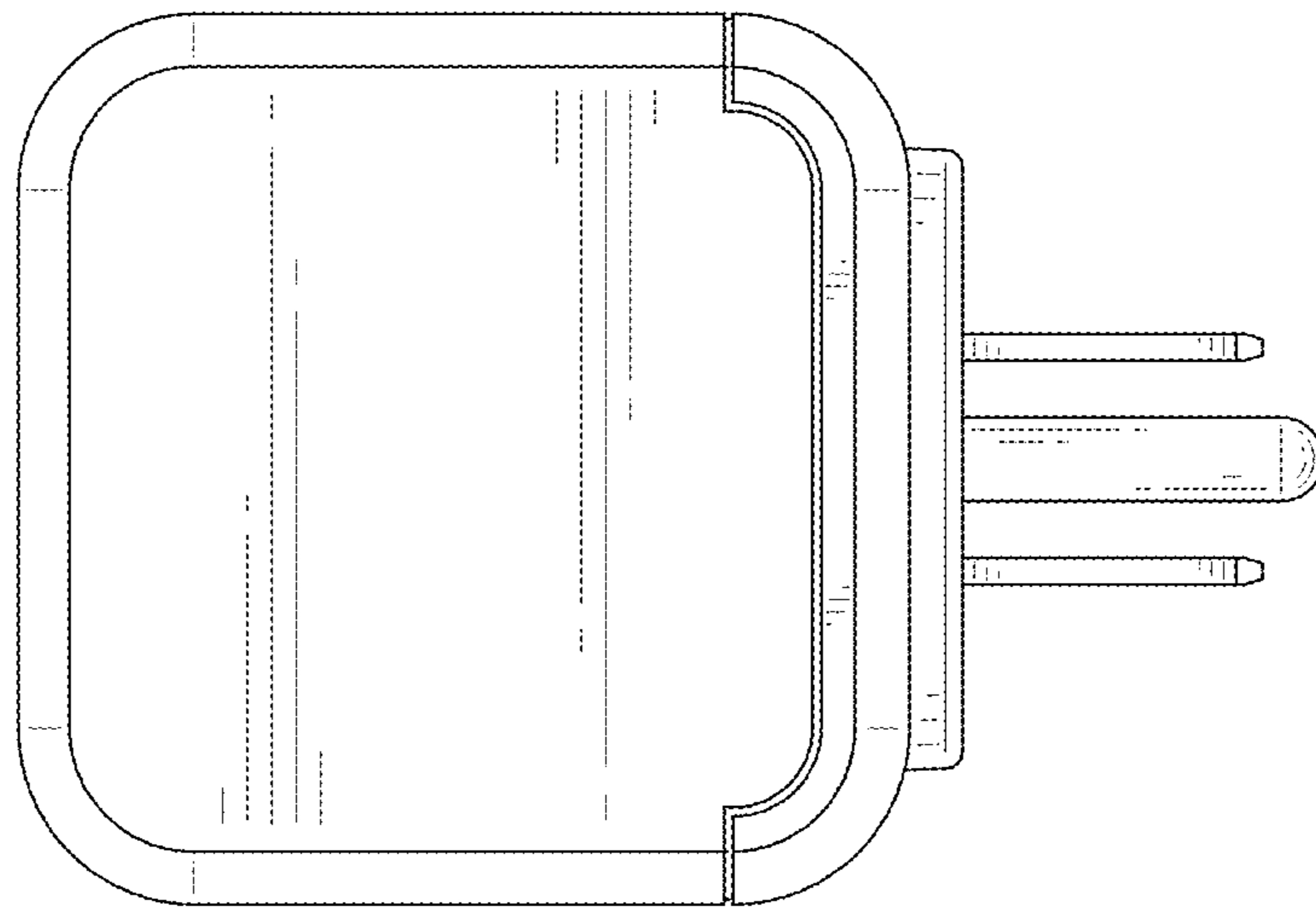

FIG. 16