



US00D894832S

(12) **United States Design Patent** (10) **Patent No.:** **US D894,832 S**  
**Khalid et al.** (45) **Date of Patent:** **\*\* Sep. 1, 2020**

(54) **SUMP PUMP POWER ADAPTER**

(71) Applicant: **Pentair Flow Technologies, LLC**,  
Delavan, WI (US)

(72) Inventors: **Hassan Khalid**, Greenfield, WI (US);  
**Nicola Sgambelluri**, Pisa (IT); **Brian Broga**,  
Elkhorn, WI (US); **Brian Boothe**, Raleigh, NC (US)

(73) Assignee: **PENTAIR FLOW TECHNOLOGIES, LLC**,  
Delavan, WI (US)

(\*\*) Term: **15 Years**

(21) Appl. No.: **29/668,623**

(22) Filed: **Oct. 31, 2018**

(51) **LOC (12) Cl.** ..... **13-02**

(52) **U.S. Cl.**  
USPC ..... **D13/110**

(58) **Field of Classification Search**  
USPC ..... D13/103, 107, 108, 110, 118, 119, 123,  
D13/133, 137.1, 137.2, 137.3, 137.4,  
(Continued)

(56) **References Cited**

U.S. PATENT DOCUMENTS

6,358,076 B1 \* 3/2002 Haag ..... H01R 13/6395  
439/320  
8,105,106 B1 \* 1/2012 Stoddard ..... H01R 13/717  
362/95

(Continued)

*Primary Examiner* — Susan Bennett Hattan

*Assistant Examiner* — Suzanne E Tisdell

(74) *Attorney, Agent, or Firm* — Husch Blackwell LLP

(57) **CLAIM**

The ornamental design for a sump pump power adapter, as shown as described.

**DESCRIPTION**

FIG. 1 is a front, top, right, isometric view of an ornamental design for a sump pump power adapter;

FIG. 2 is a front elevational view of the sump pump power adapter of FIG. 1;

FIG. 3 is a rear elevational view of the sump pump power adapter of FIG. 1.

FIG. 4 is a right side elevational view of the sump pump power adapter of FIG. 1;

FIG. 5 is a left side elevational view of the sump pump power adapter of FIG. 1;

FIG. 6 is a top plan view of the sump pump power adapter of FIG. 1;

FIG. 7 is a bottom plan view of the sump pump power adapter of FIG. 1;

FIG. 8 is a front, top, right, isometric view of another embodiment of a sump pump power adapter;

FIG. 9 is a front elevational view of the sump pump power adapter of FIG. 8;

FIG. 10 is a rear elevational view of the sump pump power adapter of FIG. 8;

FIG. 11 is a right side elevational view of the sump pump power adapter of FIG. 8;

FIG. 12 is a left side elevational view of the sump pump power adapter of FIG. 8;

FIG. 13 is a top plan view of the sump pump power adapter of FIG. 8;

FIG. 14 is a bottom plan view of the sump pump power adapter of FIG. 8;

FIG. 15 is a front, top, right, isometric view of a further embodiment of a sump pump power adapter;

FIG. 16 is a front elevational view of the sump pump power adapter of FIG. 15;

FIG. 17 is a rear elevational view of the sump pump power adapter of FIG. 15;

FIG. 18 is a right side elevational view of the sump pump power adapter of FIG. 15;

FIG. 19 is a left side elevational view of the sump pump power adapter of FIG. 15;

FIG. 20 is a top plan view of the sump pump power adapter of FIG. 15;

FIG. 21 is a bottom plan view of the sump pump power adapter of FIG. 15;

FIG. 22 is a front, top, right, isometric view of another embodiment of a sump pump power adapter;

FIG. 23 is a front elevational view of the sump pump power adapter of FIG. 22;

(Continued)

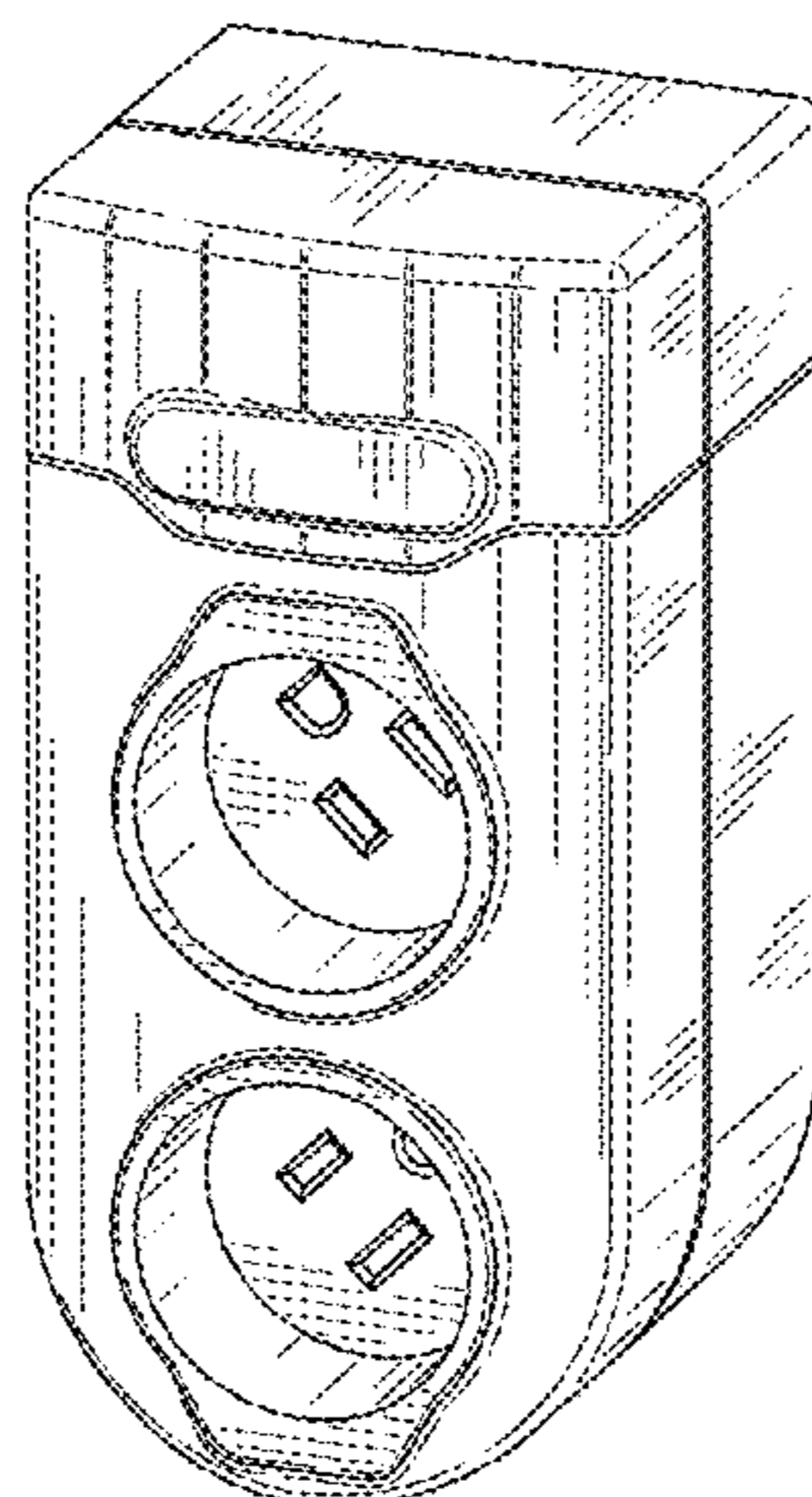

FIG. 24 is a rear elevational view of the sump pump power adapter of FIG. 22;  
 FIG. 25 is a right side elevational view of the sump pump power adapter of FIG. 22;  
 FIG. 26 is a left side elevational view of the sump pump power adapter of FIG. 22;  
 FIG. 27 is a top plan view of the sump pump power adapter of FIG. 22; and,  
 FIG. 28 is a bottom plan view of the sump pump power adapter of FIG. 22.  
 The dash-dash-dash lines are for the purpose of illustrating environmental structure and form no part of the claimed design.

**1 Claim, 20 Drawing Sheets**

(58) **Field of Classification Search**

USPC ..... D13/138.1, 138.2, 139.1, 139.2, 139.3,  
 D13/139.4, 139.5, 139.6, 139.7, 139.8,  
 D13/152, 153, 154, 184, 199  
 CPC ..... H01R 25/00; H01R 25/006; H01R 13/00;  
 H01R 13/04; H01R 13/10; H01R  
 13/6666; H01R 13/6675; H01R 9/00;  
 H01R 11/00

See application file for complete search history.

(56)

**References Cited**

U.S. PATENT DOCUMENTS

8,142,228	B1 *	3/2012	Wu .....	H01R 27/02 439/628
D693,767	S *	11/2013	Zaslavsky .....	D13/110
D702,633	S *	4/2014	Andre .....	H01R 31/065 D13/110
D735,669	S *	8/2015	Kelly .....	D13/138.1
D753,661	S *	4/2016	Daniel .....	D14/433
9,537,276	B1 *	1/2017	Cai .....	H01R 31/06
D778,914	S *	2/2017	Huang .....	D13/110
D788,709	S *	6/2017	Yeo .....	D13/137.2
D790,465	S *	6/2017	Zhao .....	D13/110
D799,422	S *	10/2017	Chen .....	D13/108
D807,822	S *	1/2018	Senff .....	D13/110
D808,903	S *	1/2018	Koenig .....	D13/110
9,882,313	B2 *	1/2018	Steinbuchel, IV .....	H01R 31/06
D819,566	S *	6/2018	Hung .....	D13/110
D826,858	S *	8/2018	Little .....	D13/137.2
D826,859	S *	8/2018	Little .....	D13/137.2
D864,863	S *	10/2019	Lee .....	D13/110
D867,287	S *	11/2019	Akana .....	D13/110
D867,295	S *	11/2019	Shaopeng .....	D13/137.2
D867,989	S *	11/2019	Akana .....	D13/110
10,483,694	B2 *	11/2019	Crowder .....	H01R 13/447
D874,400	S *	2/2020	Akana .....	D13/110
D874,403	S *	2/2020	Canizares .....	D13/137.2
D879,714	S *	3/2020	Zhang .....	D13/110

\* cited by examiner

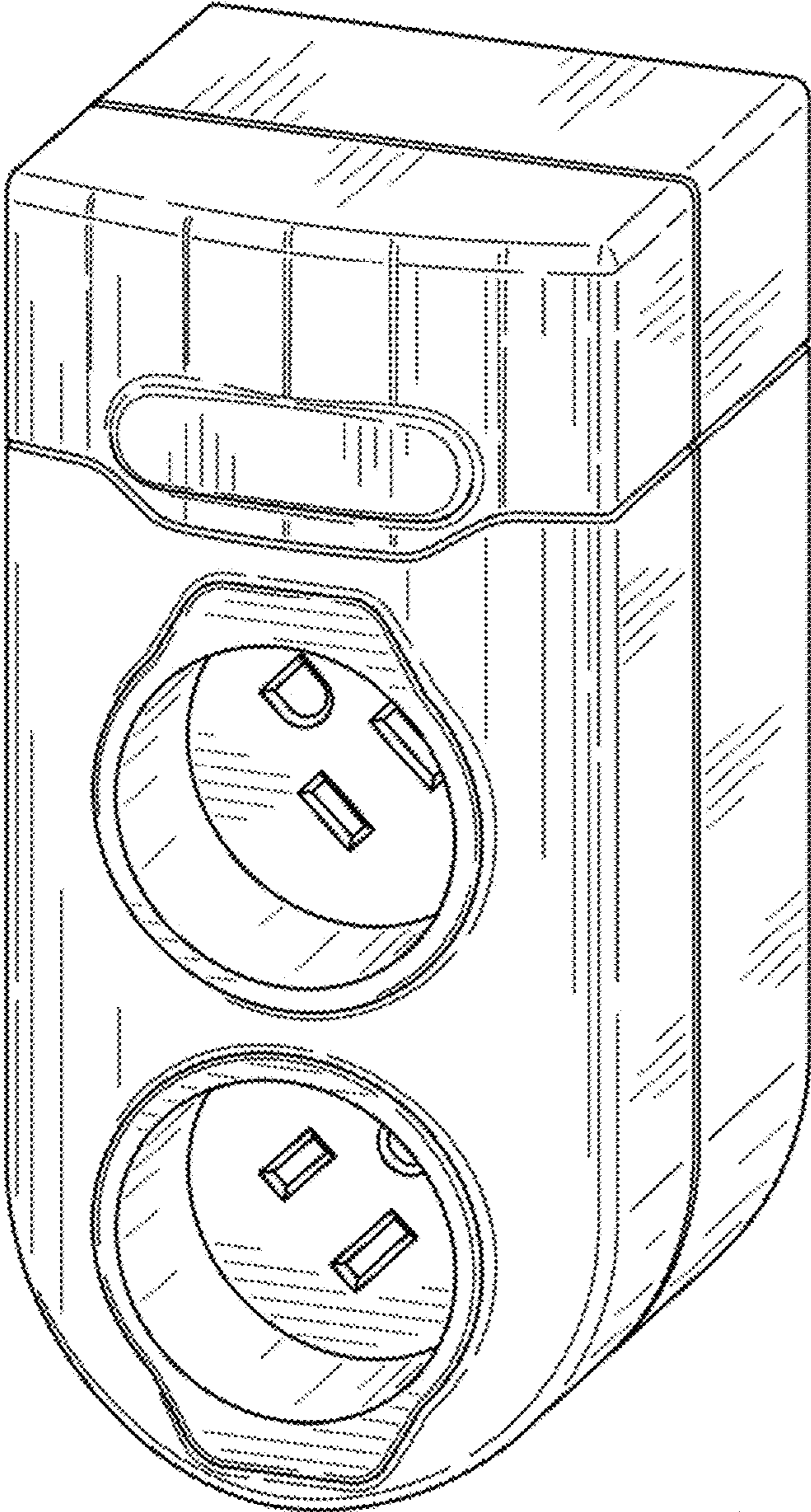

FIG. 1

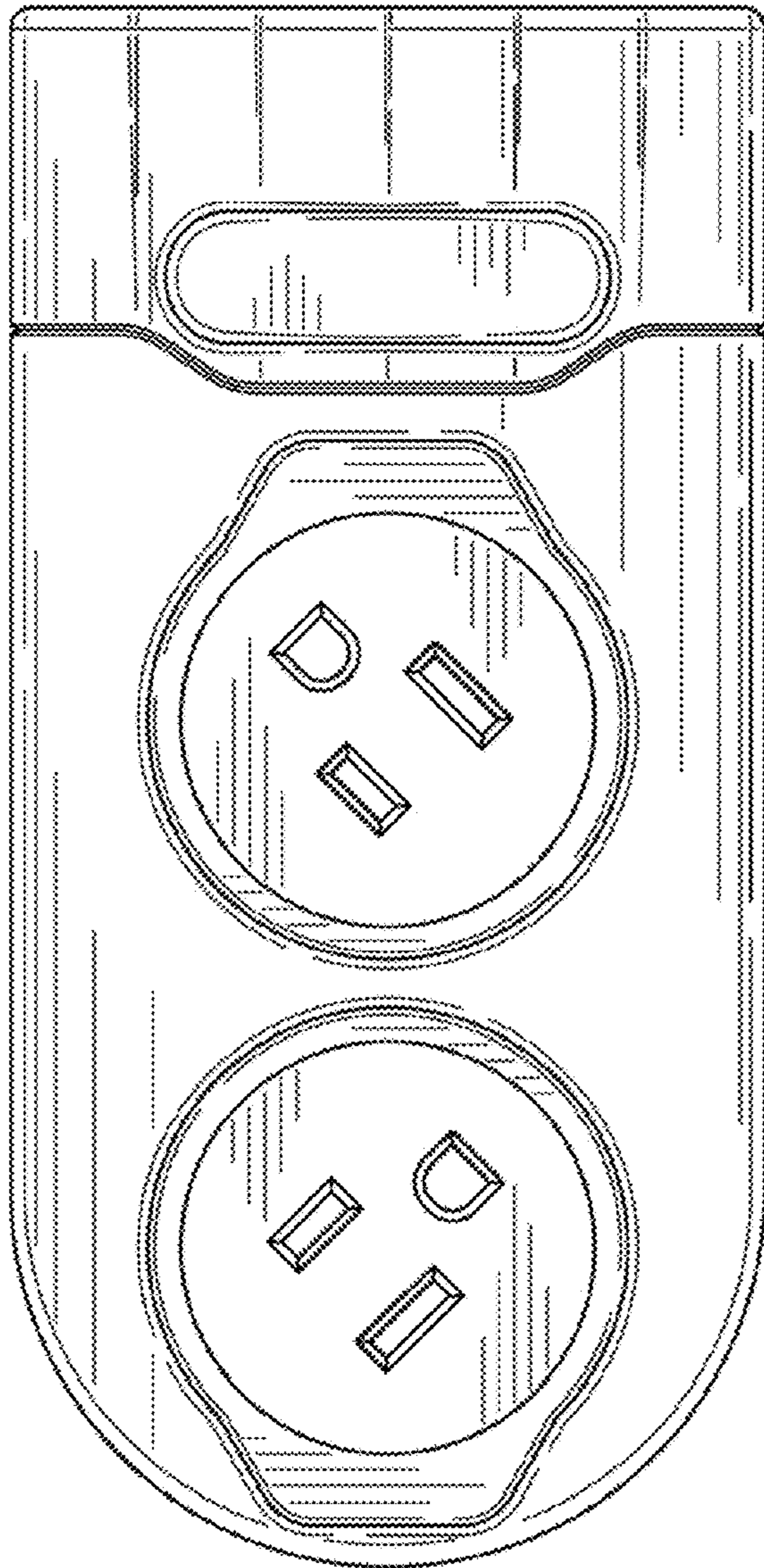

FIG. 2

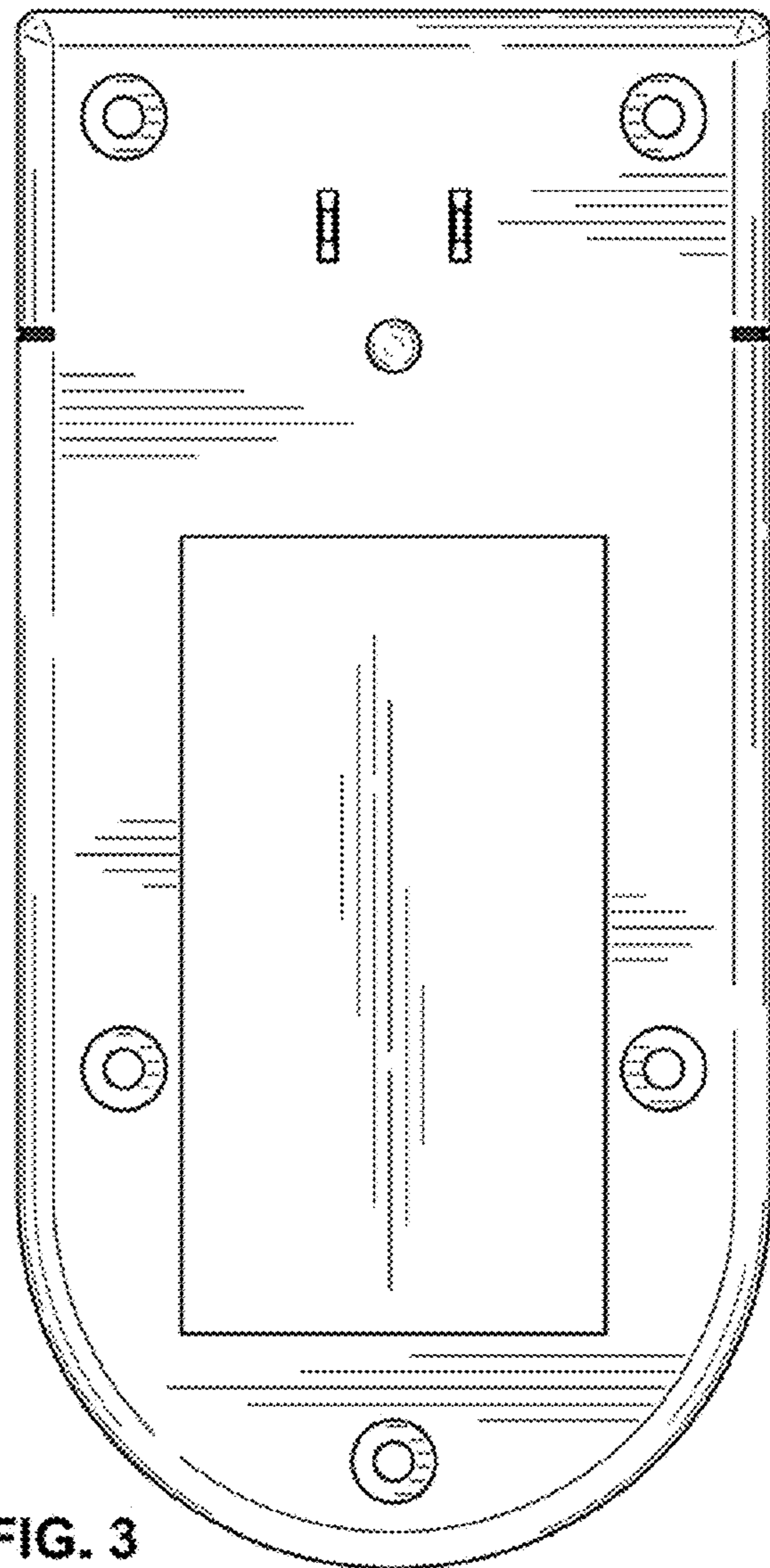

FIG. 3

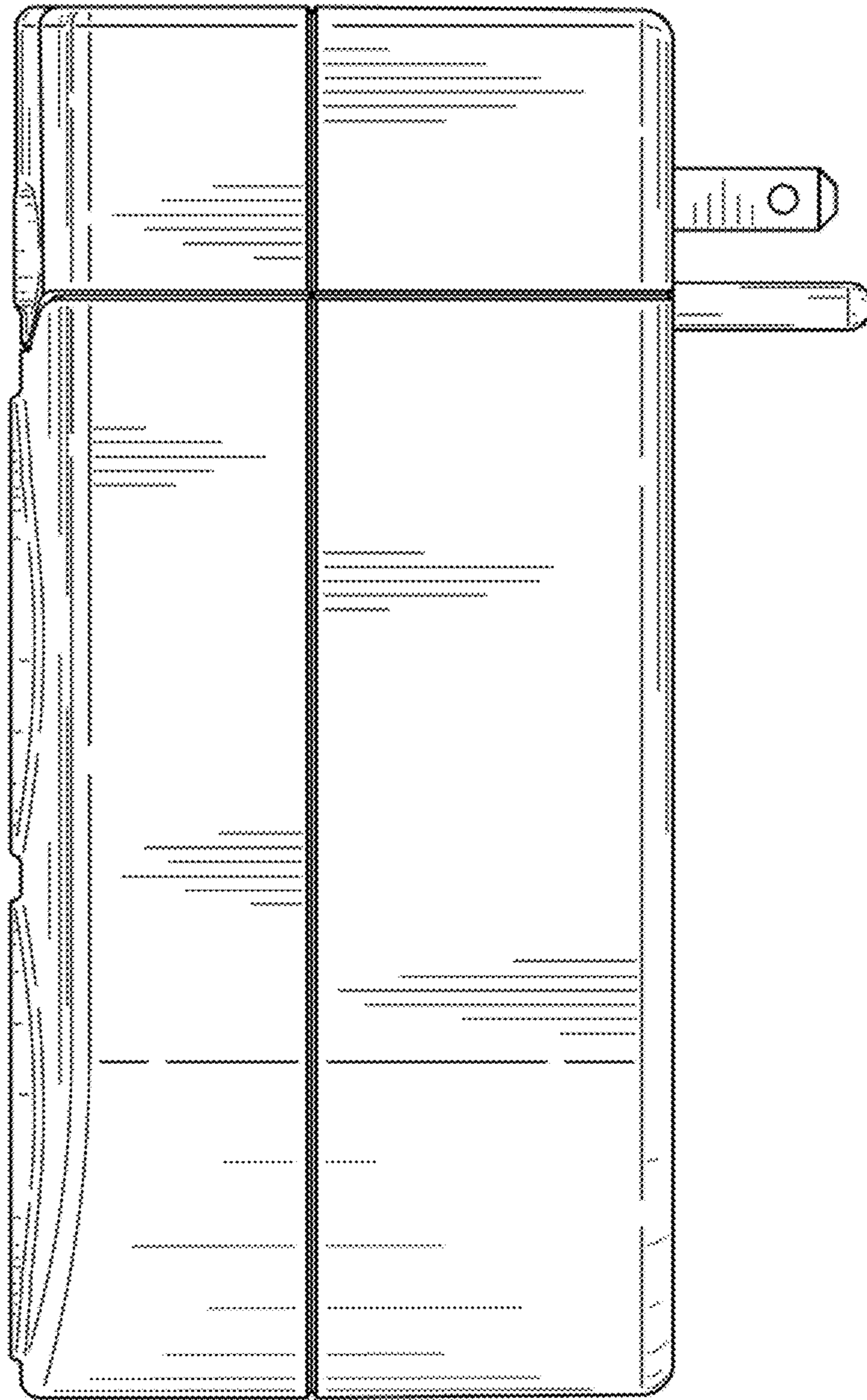

FIG. 4

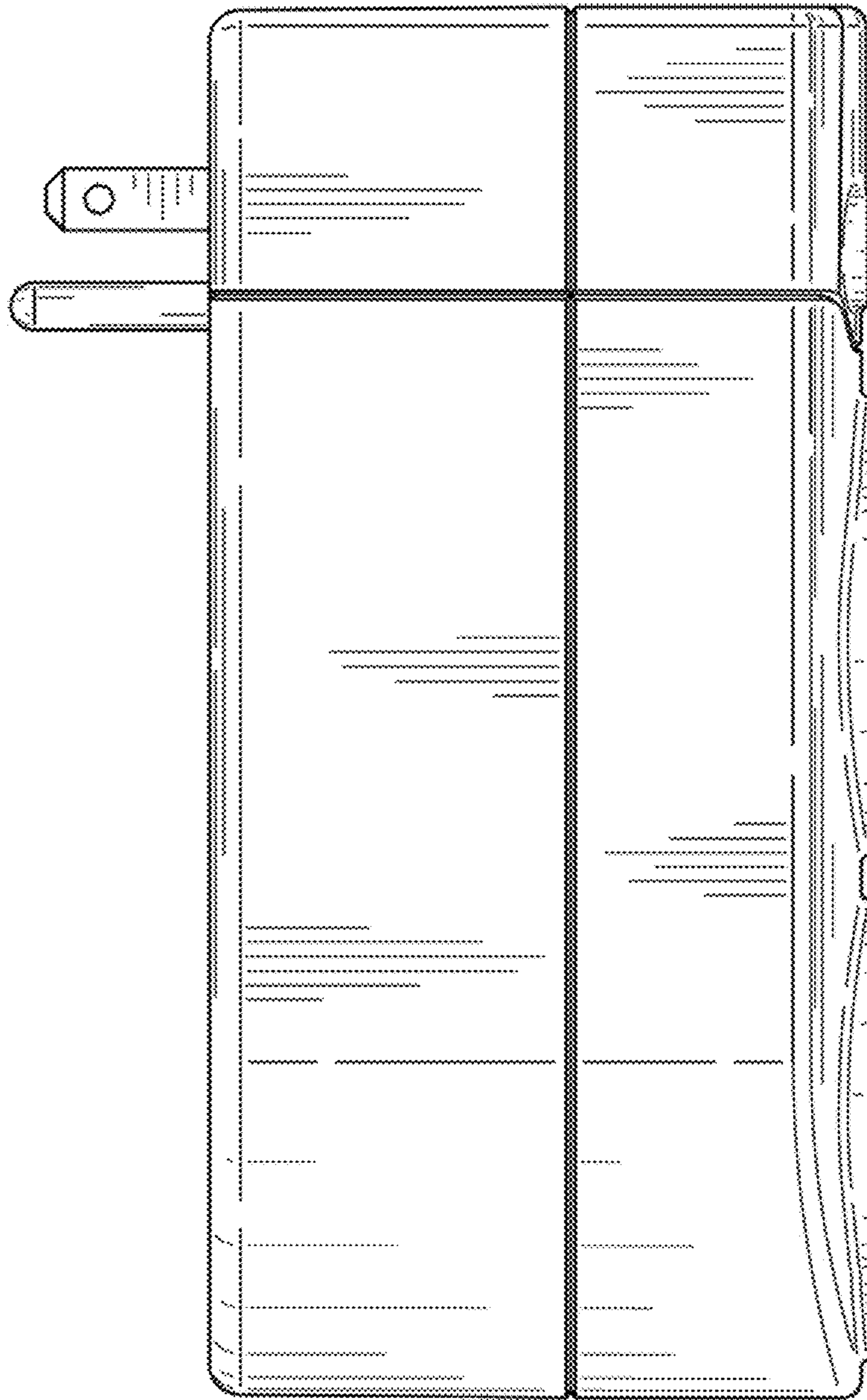

FIG. 5

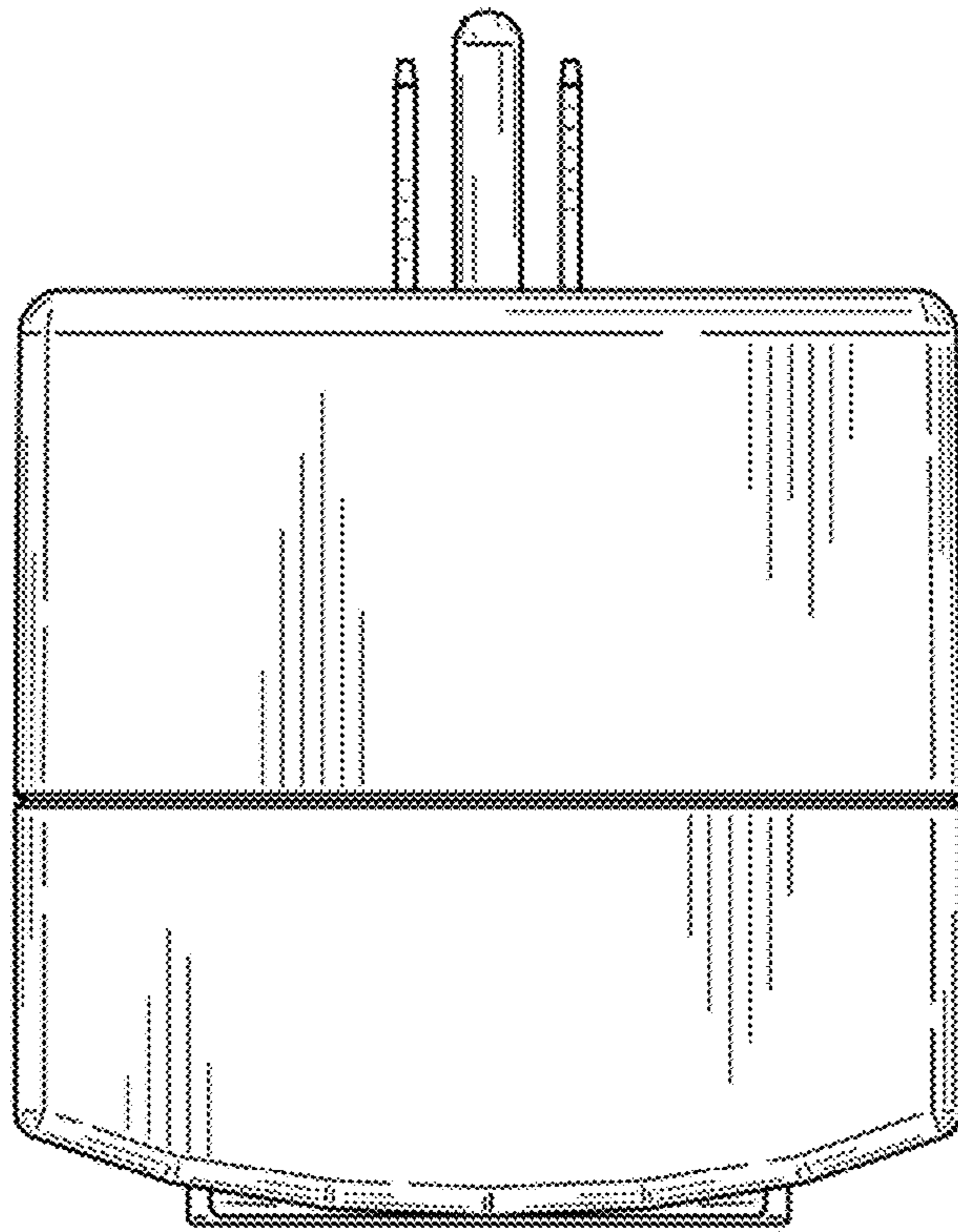

FIG. 6

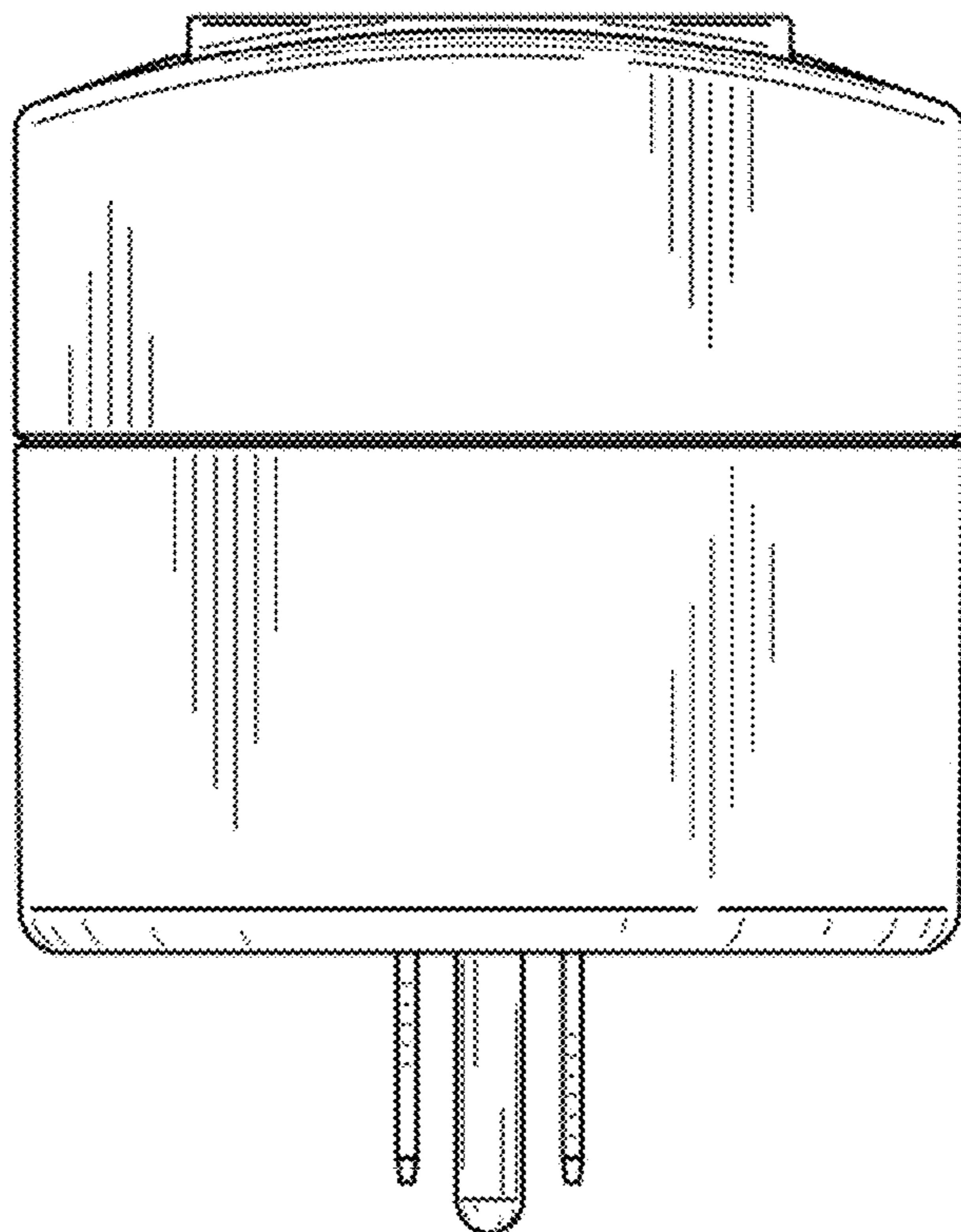

FIG. 7

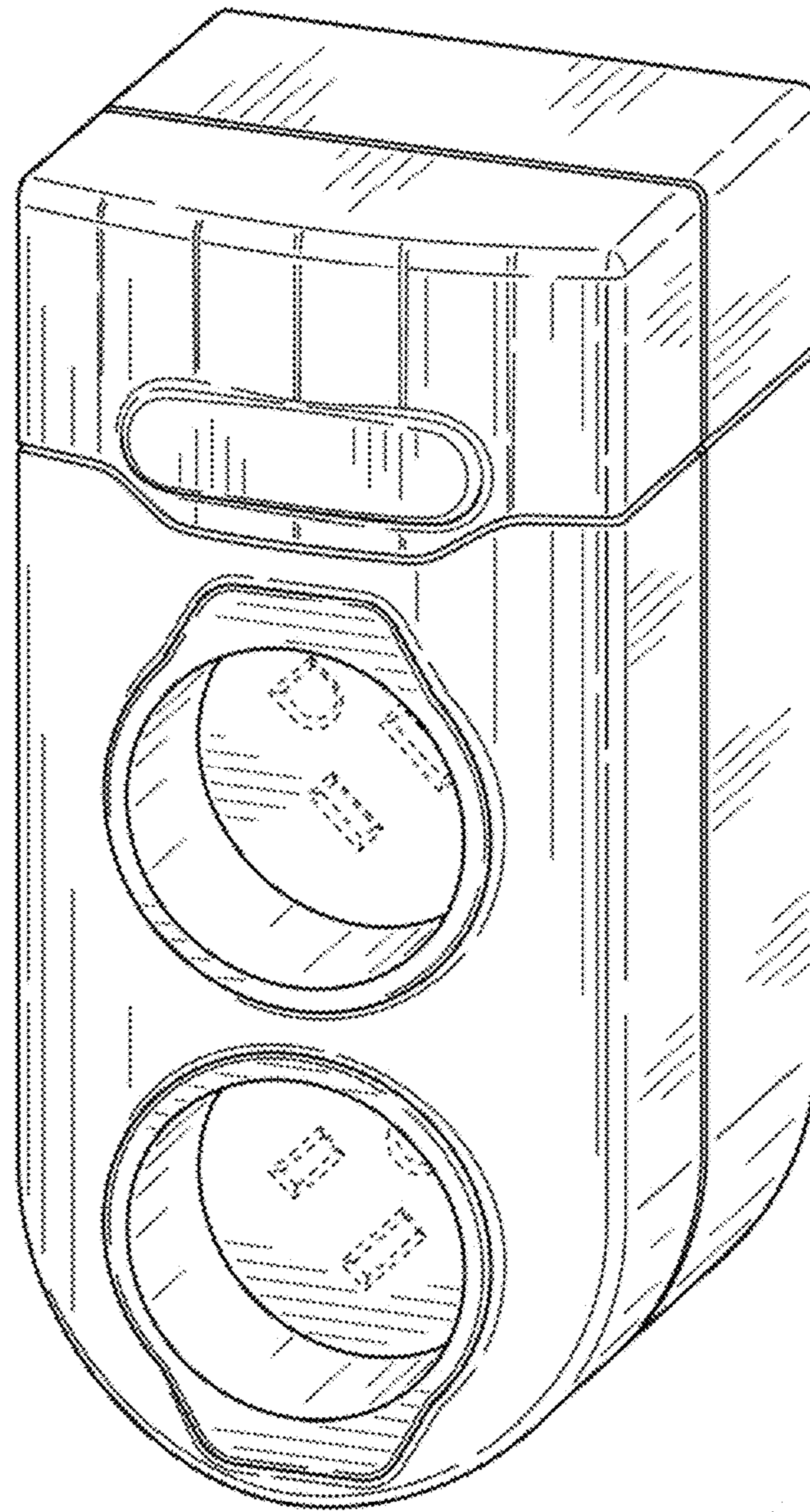

FIG. 8



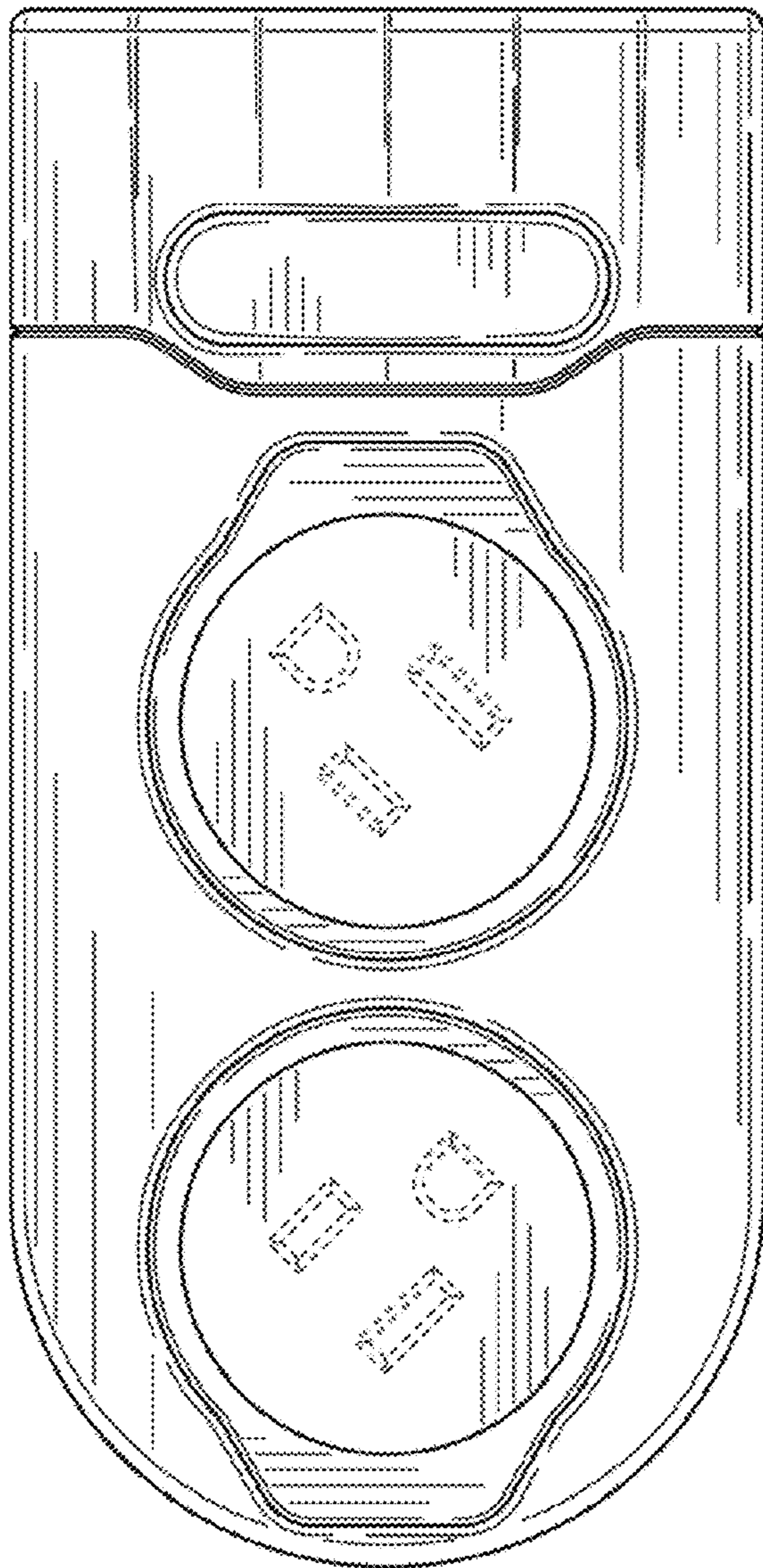

FIG. 9

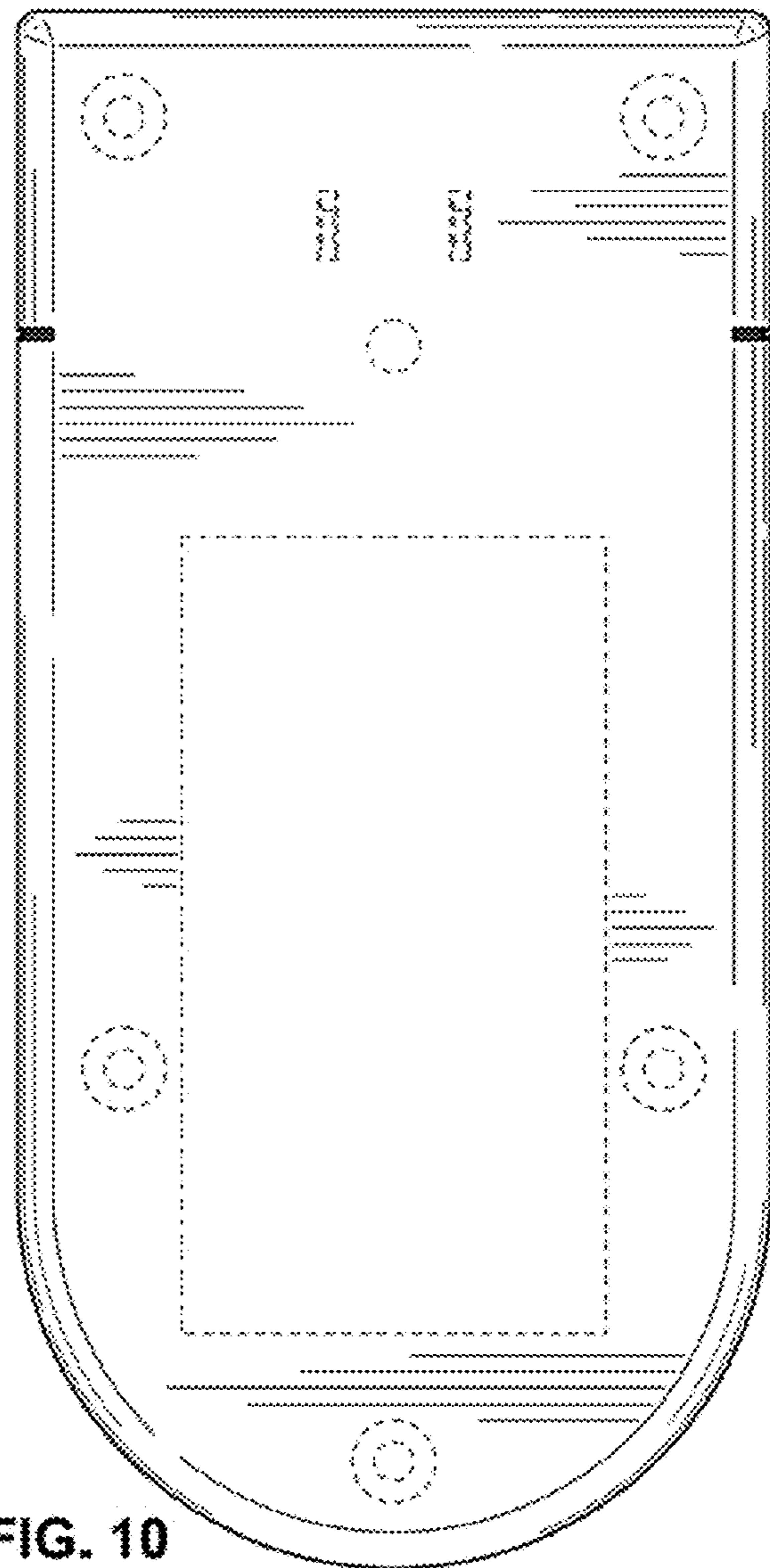

FIG. 10

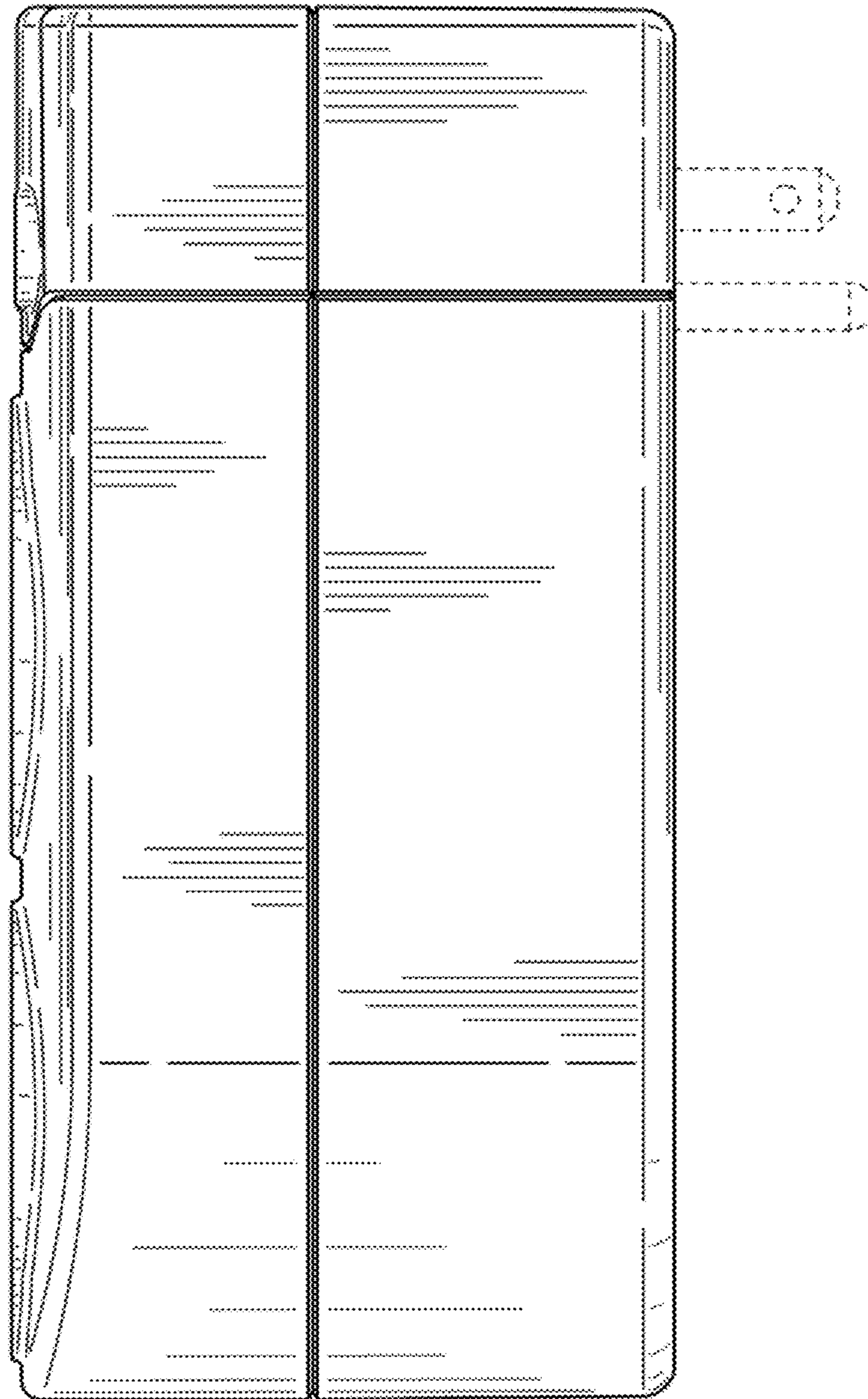

FIG. 11

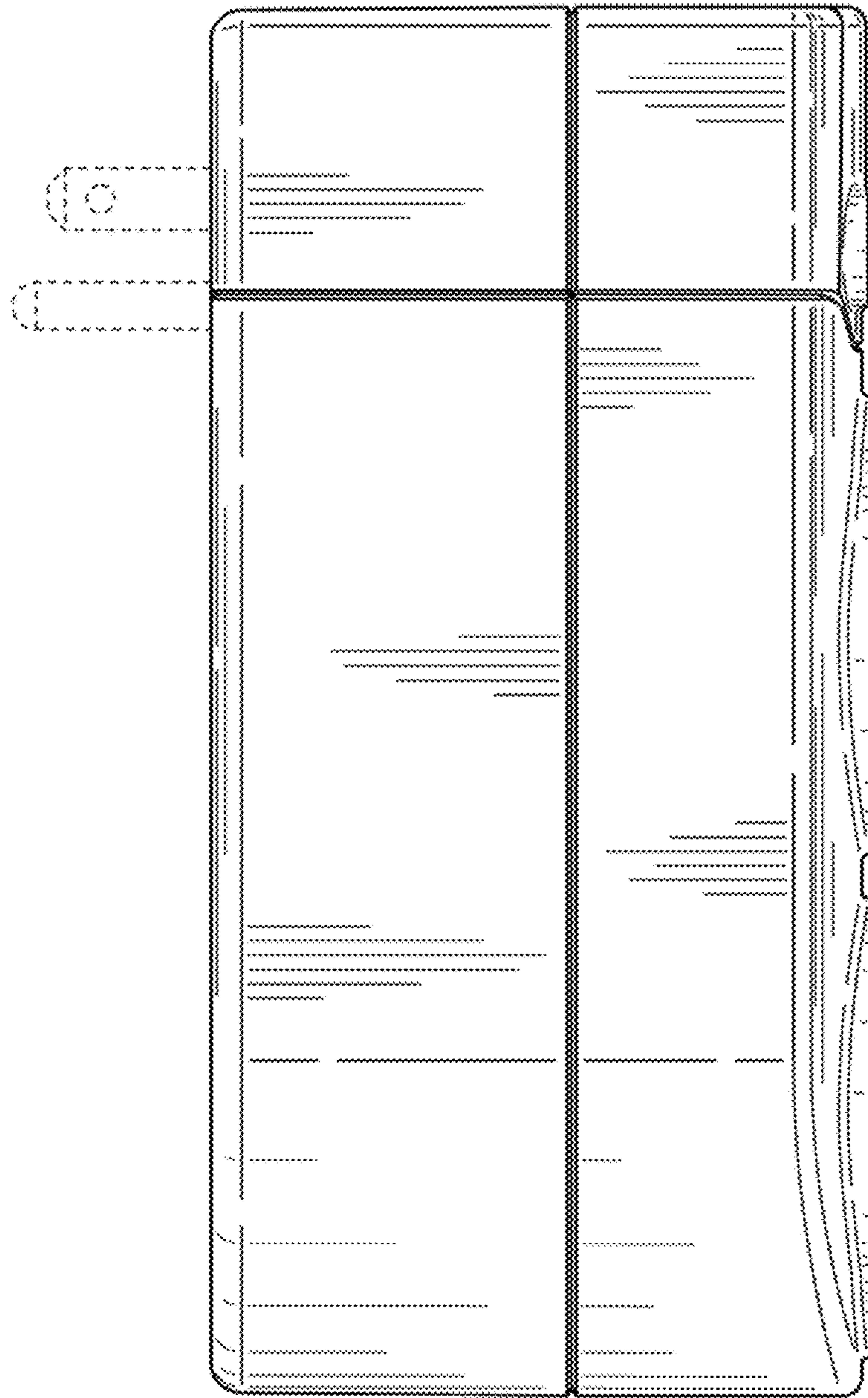

FIG. 12

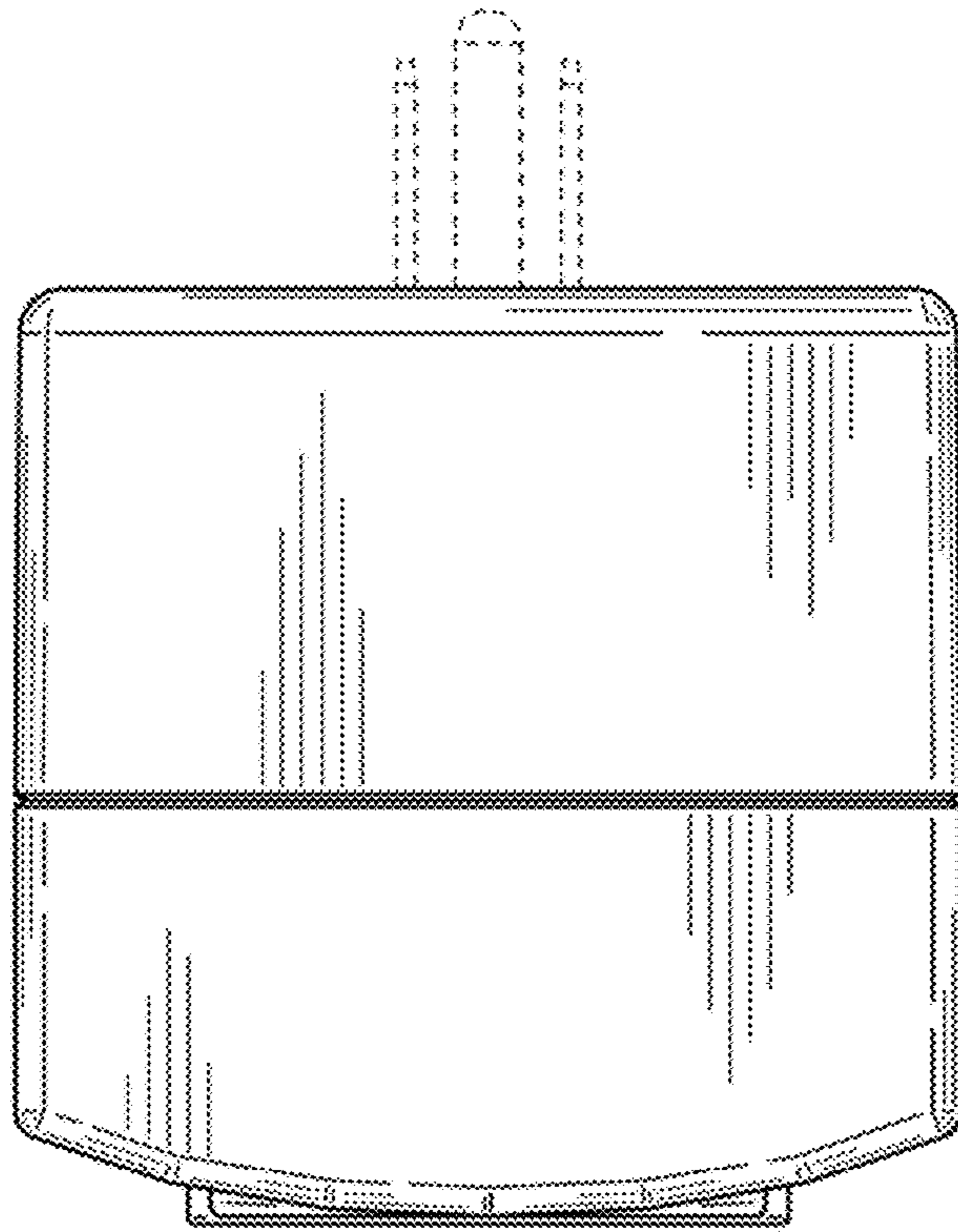

FIG. 13

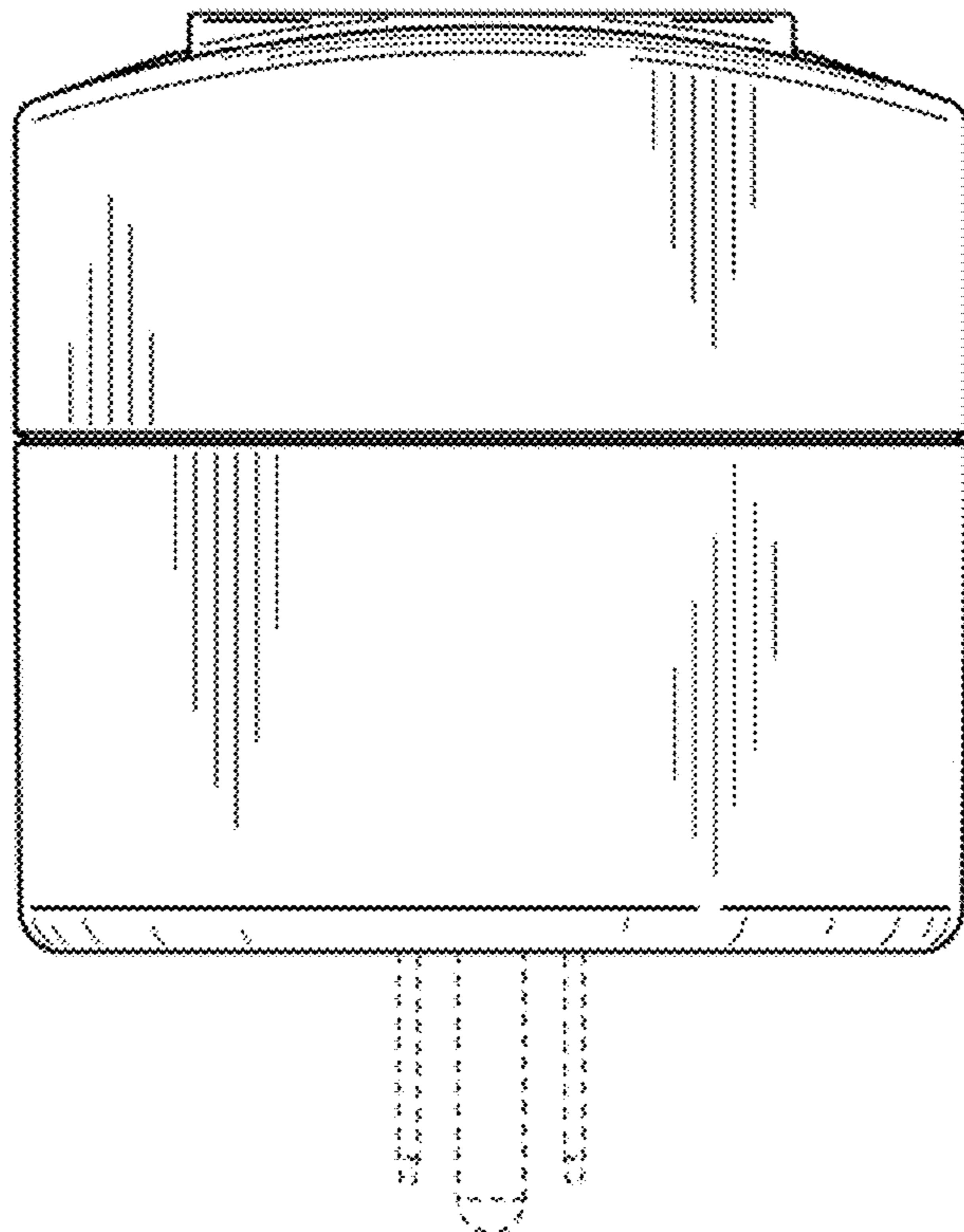

FIG. 14

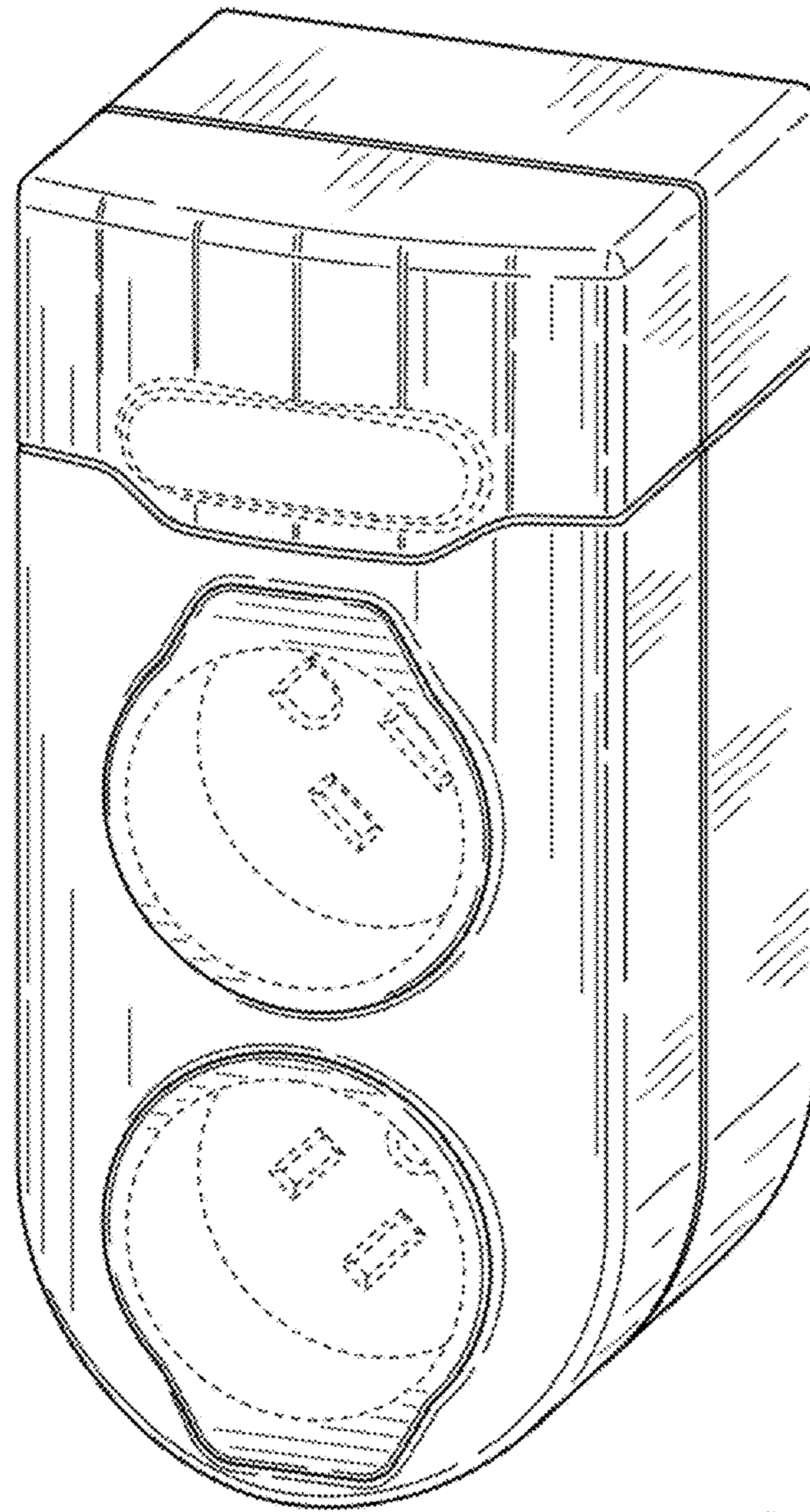

FIG. 15

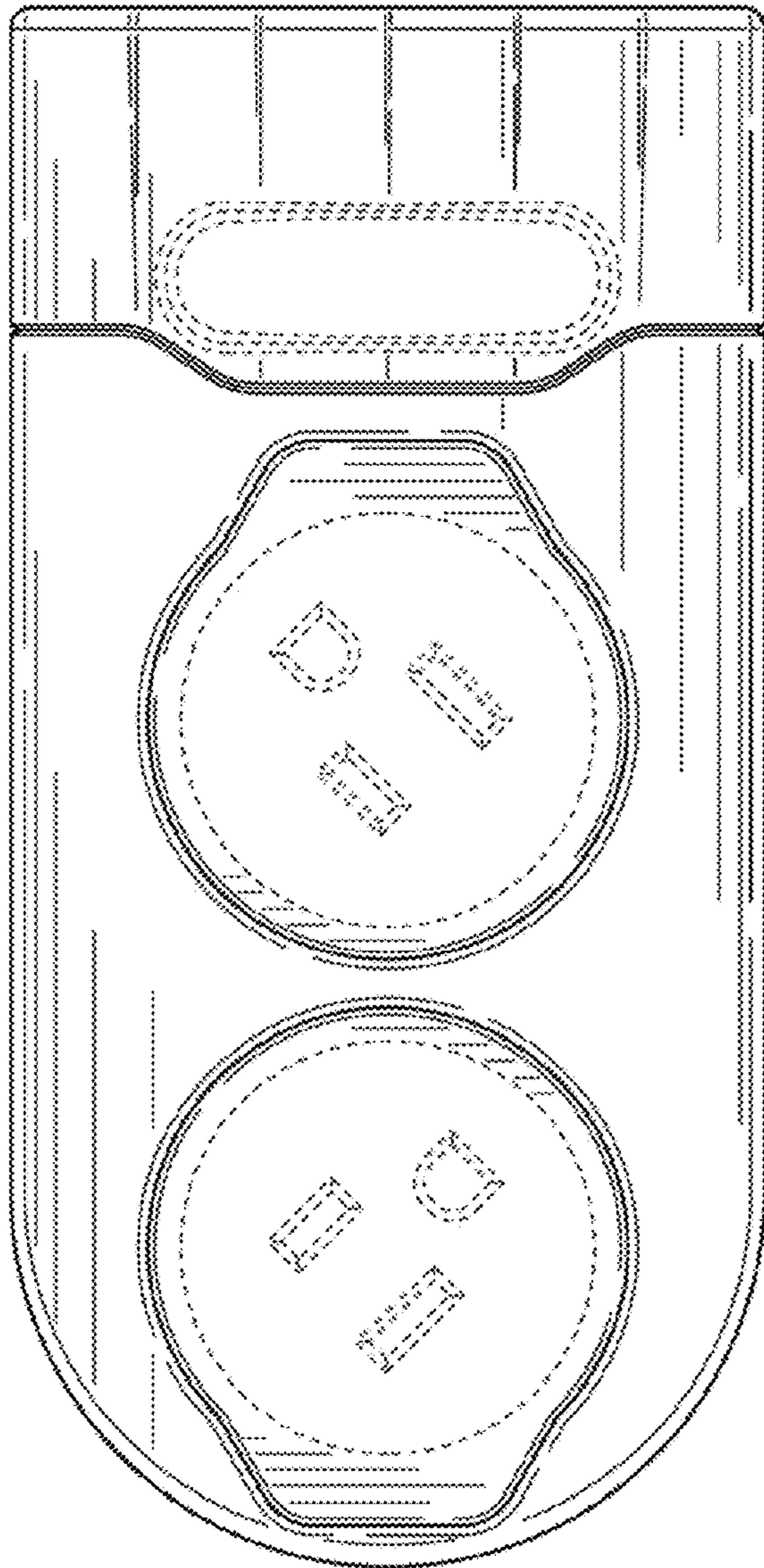

FIG. 16

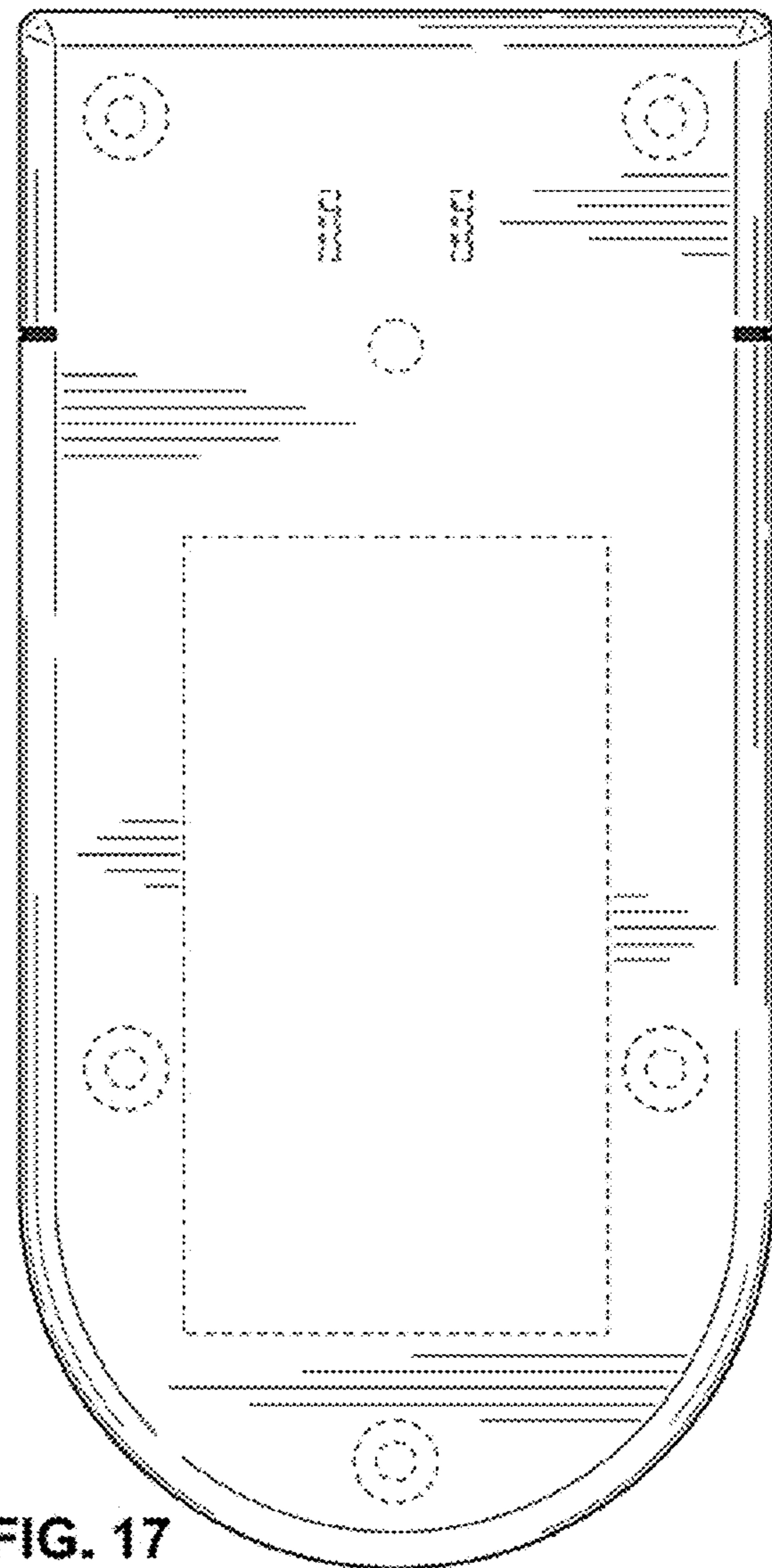

FIG. 17

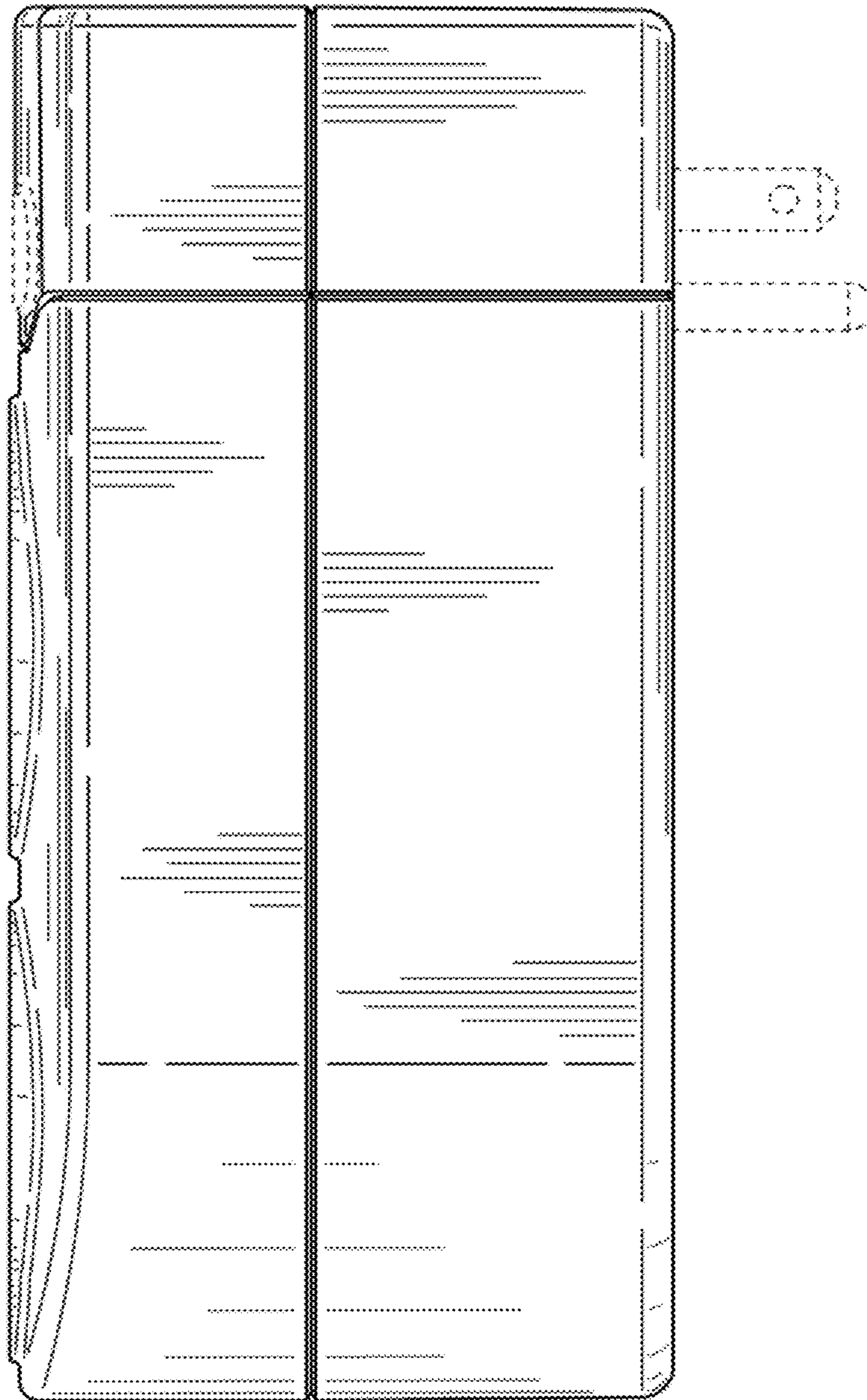

FIG. 18

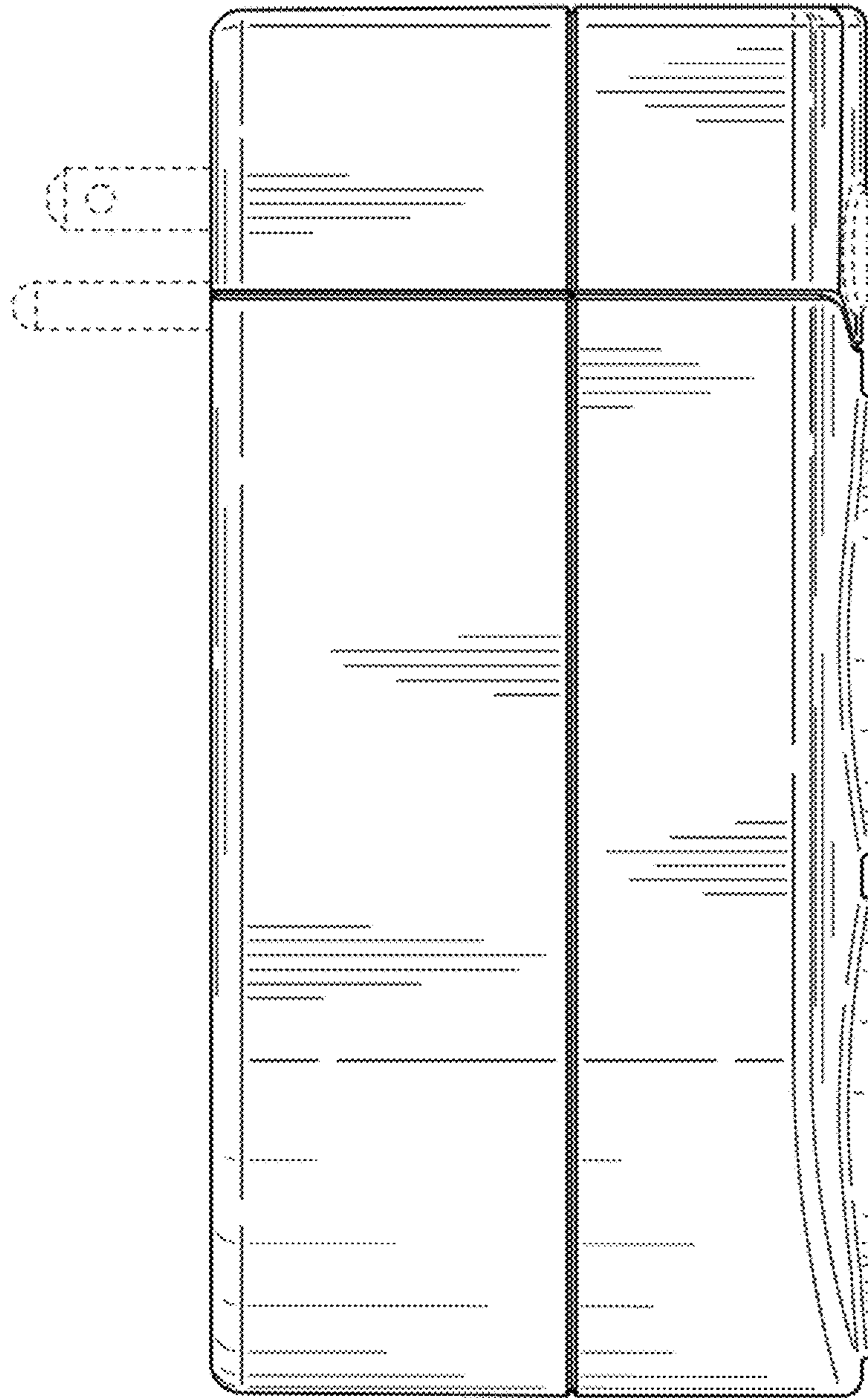

FIG. 19



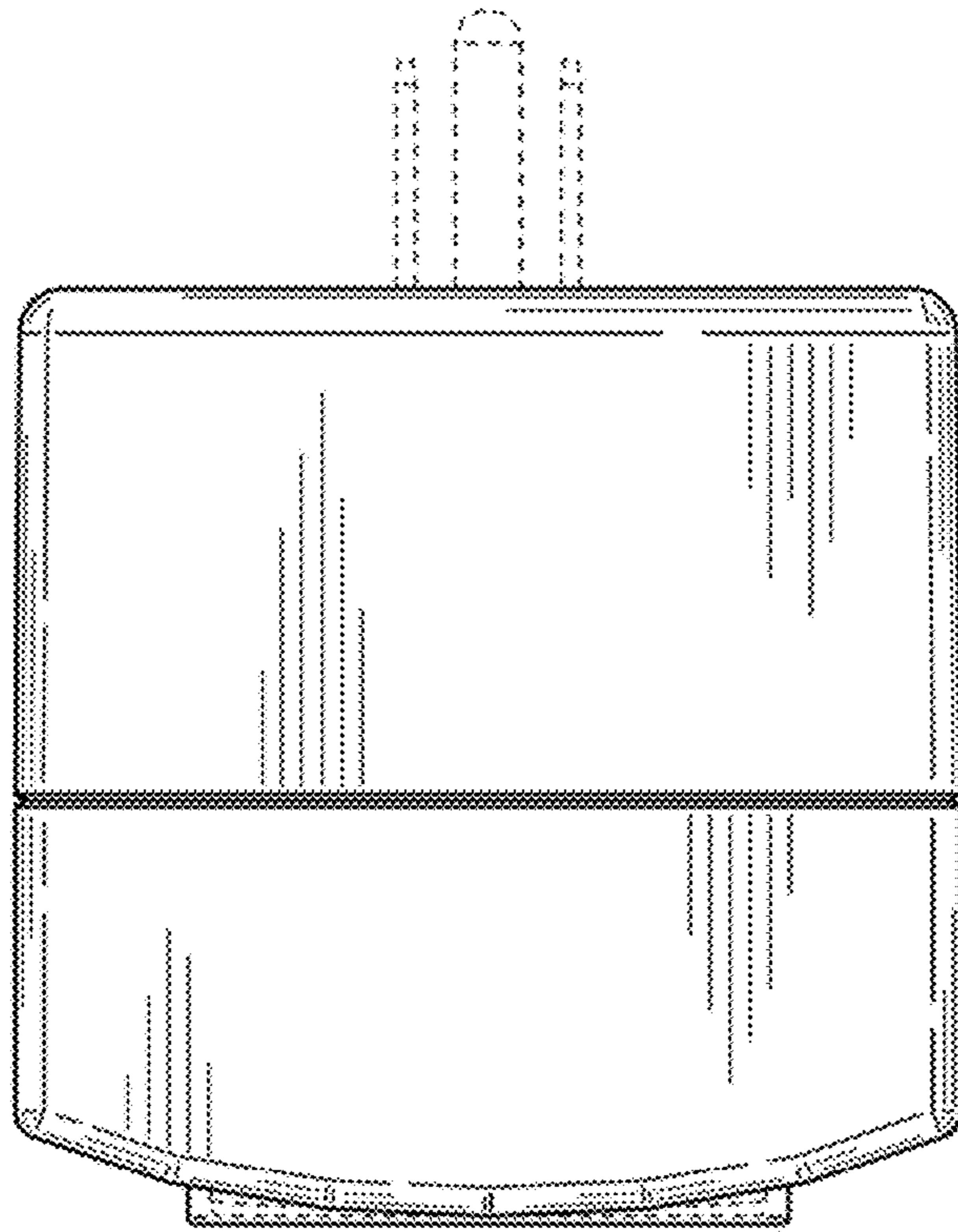

FIG. 20

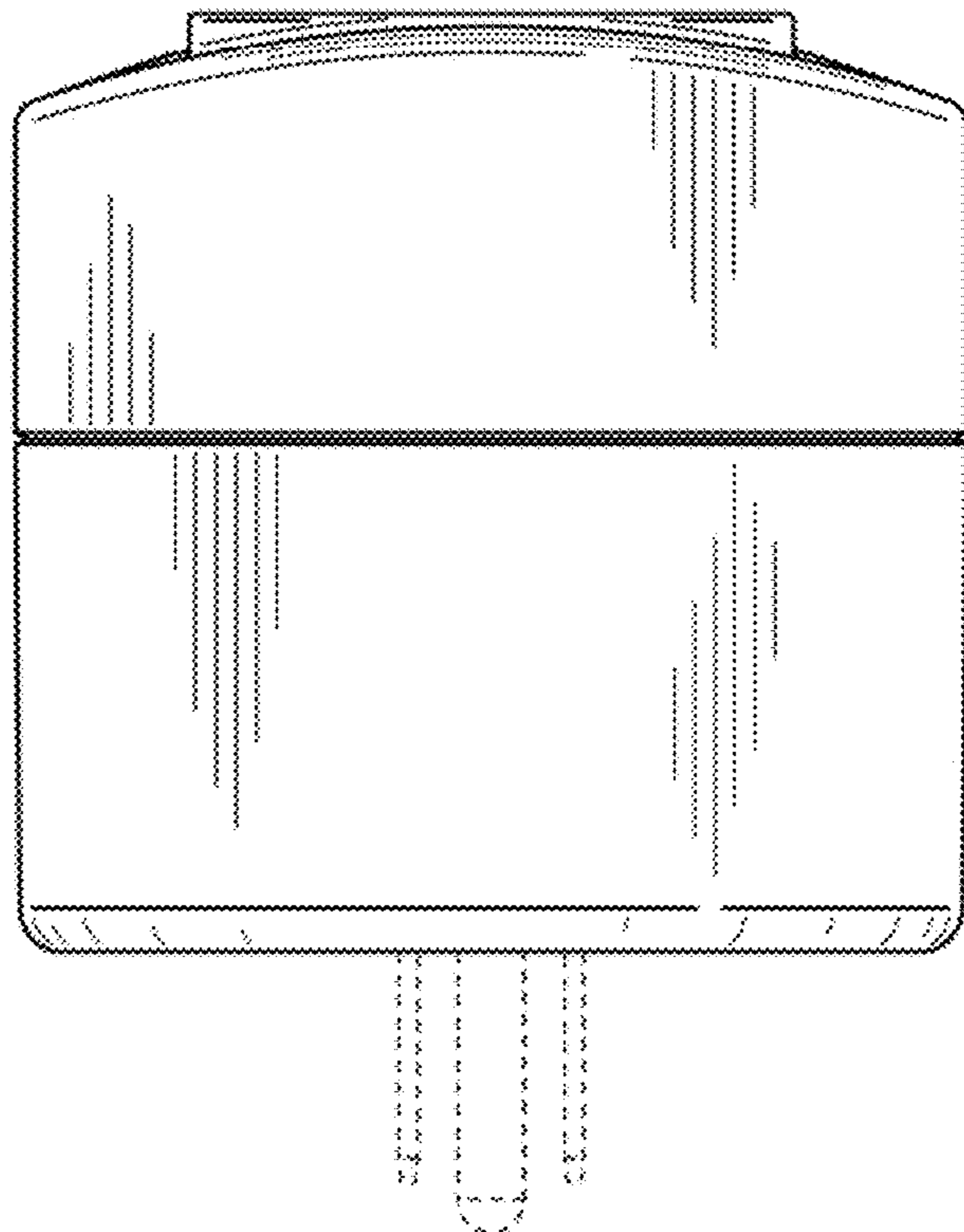

FIG. 21

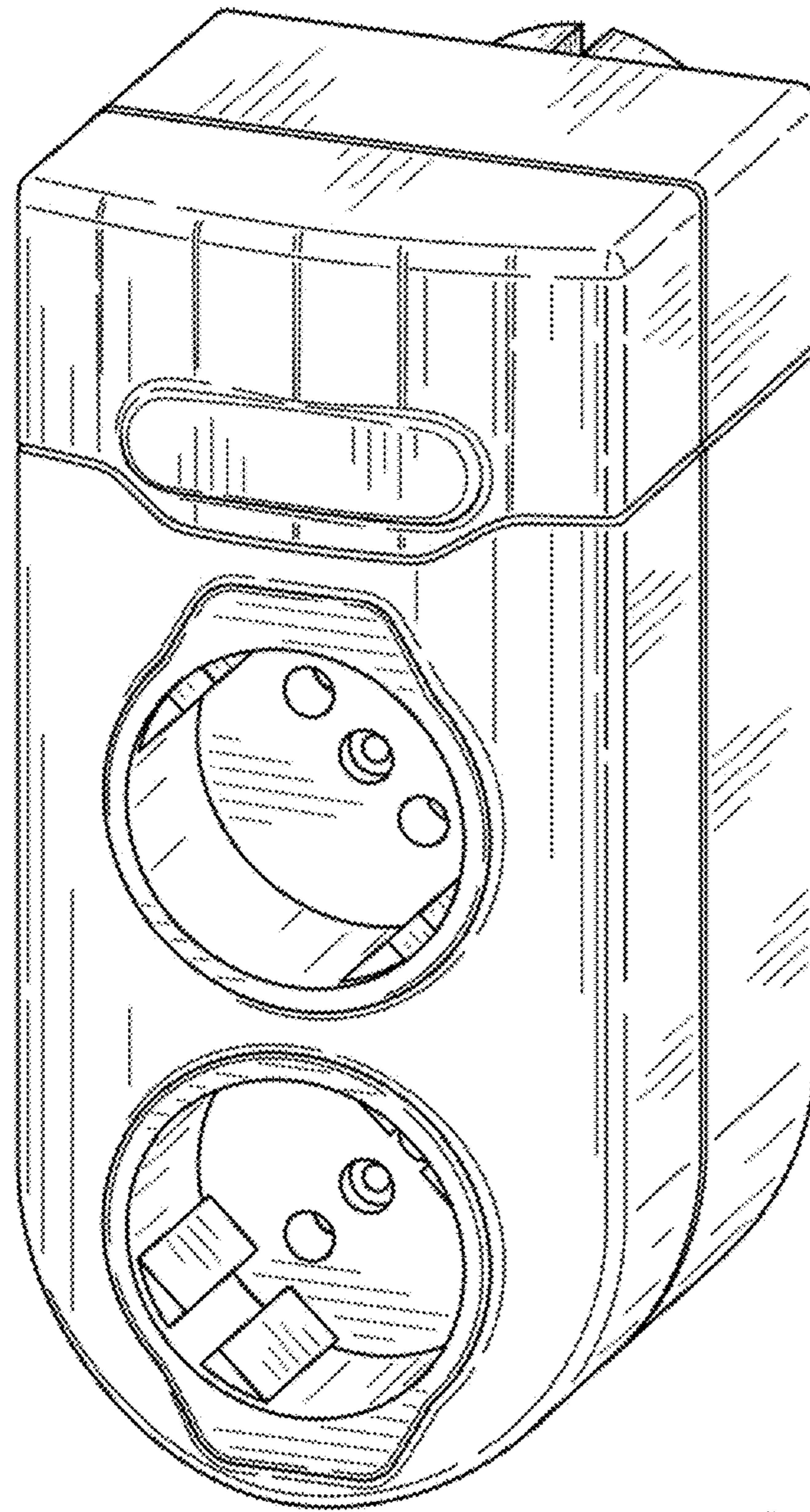

FIG. 22

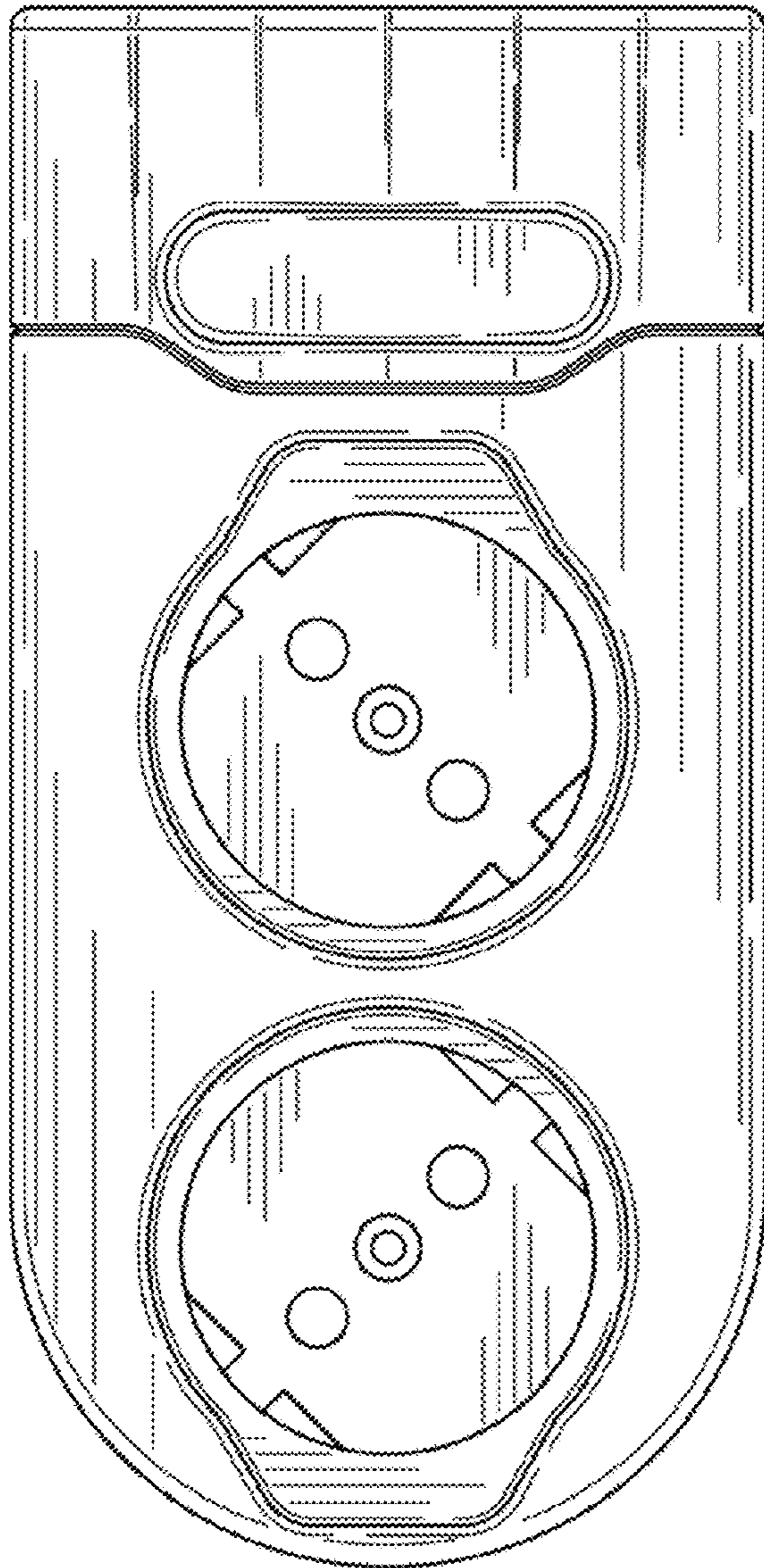

FIG. 23

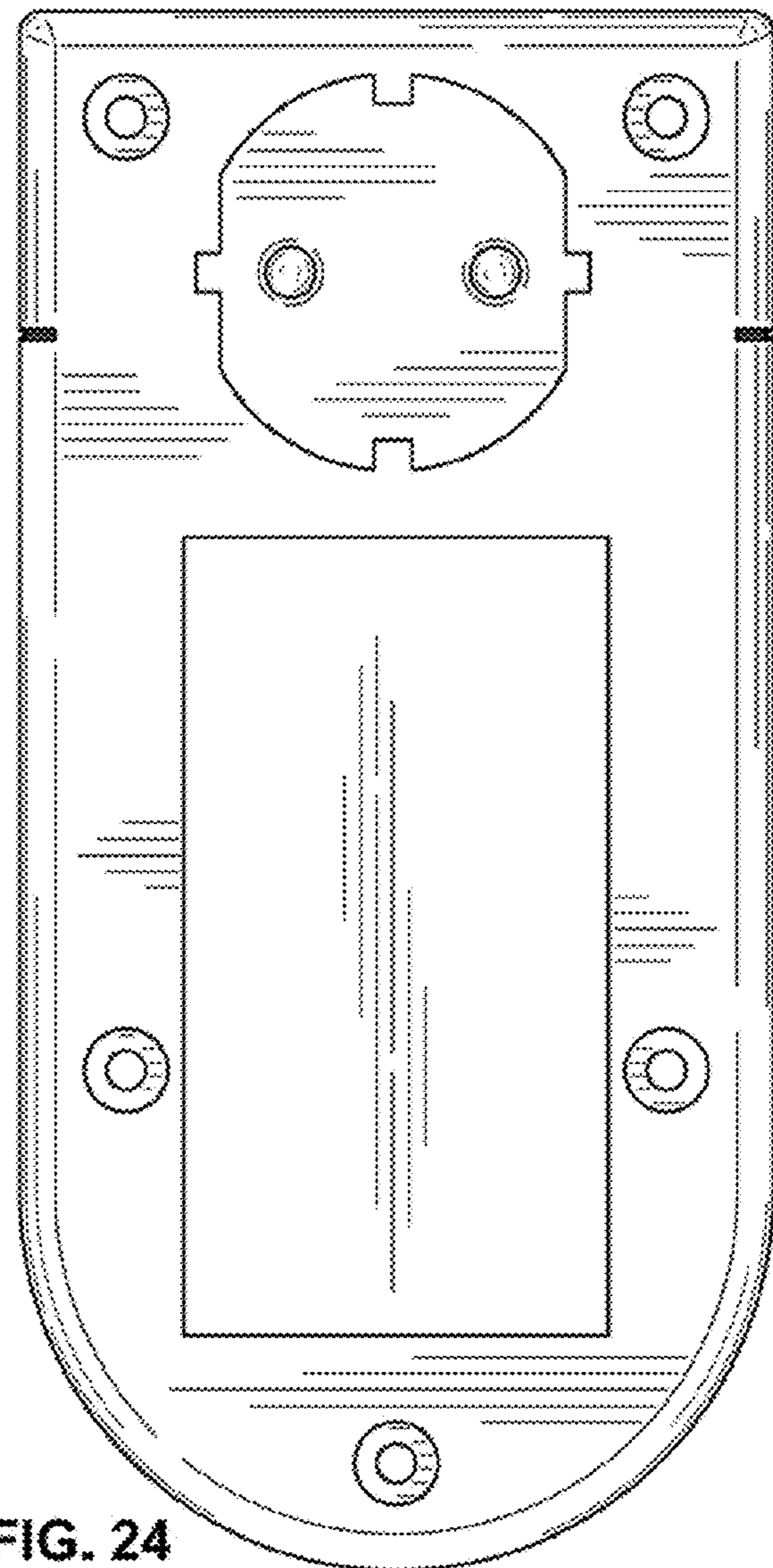

FIG. 24

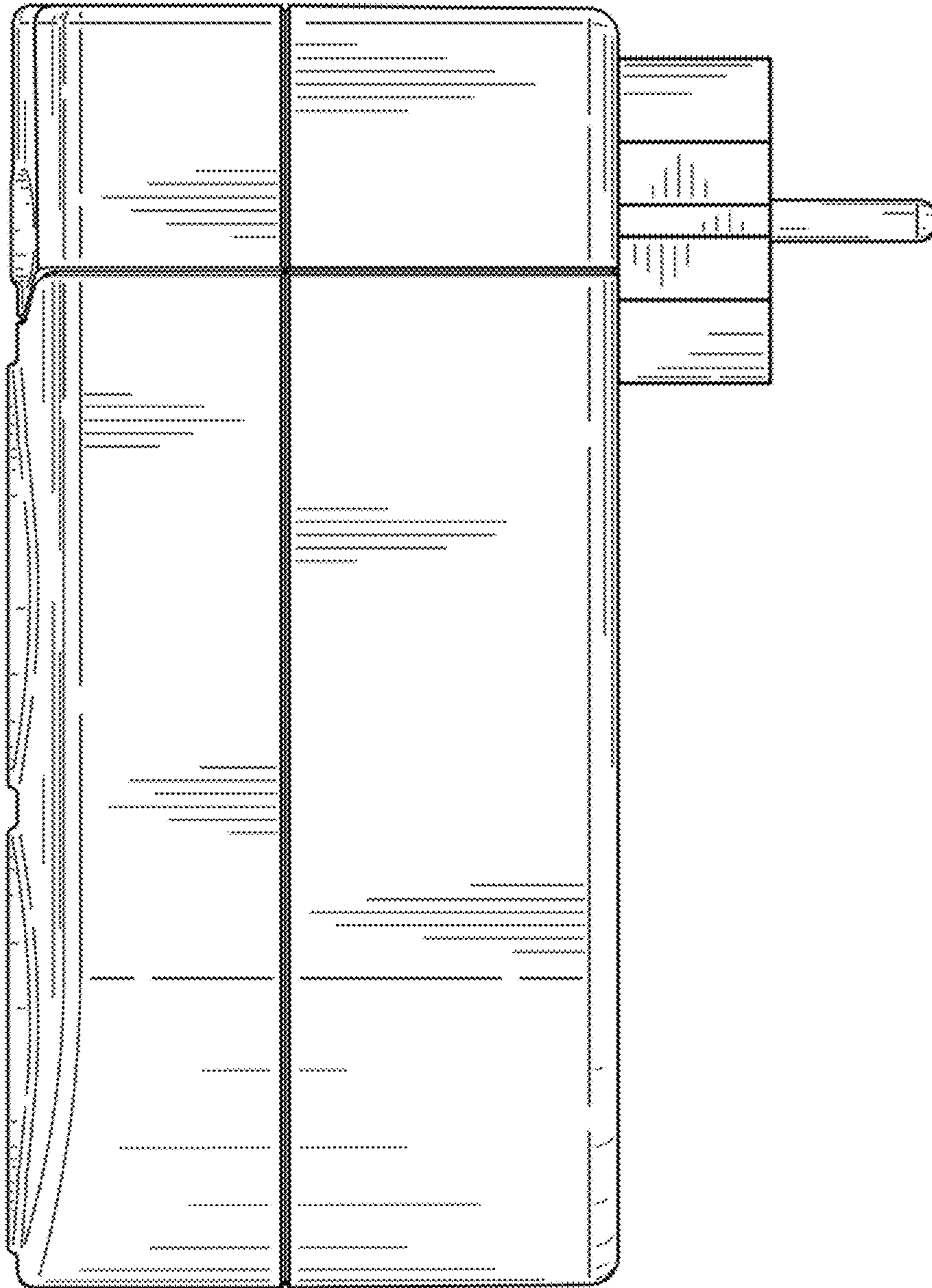

FIG. 25

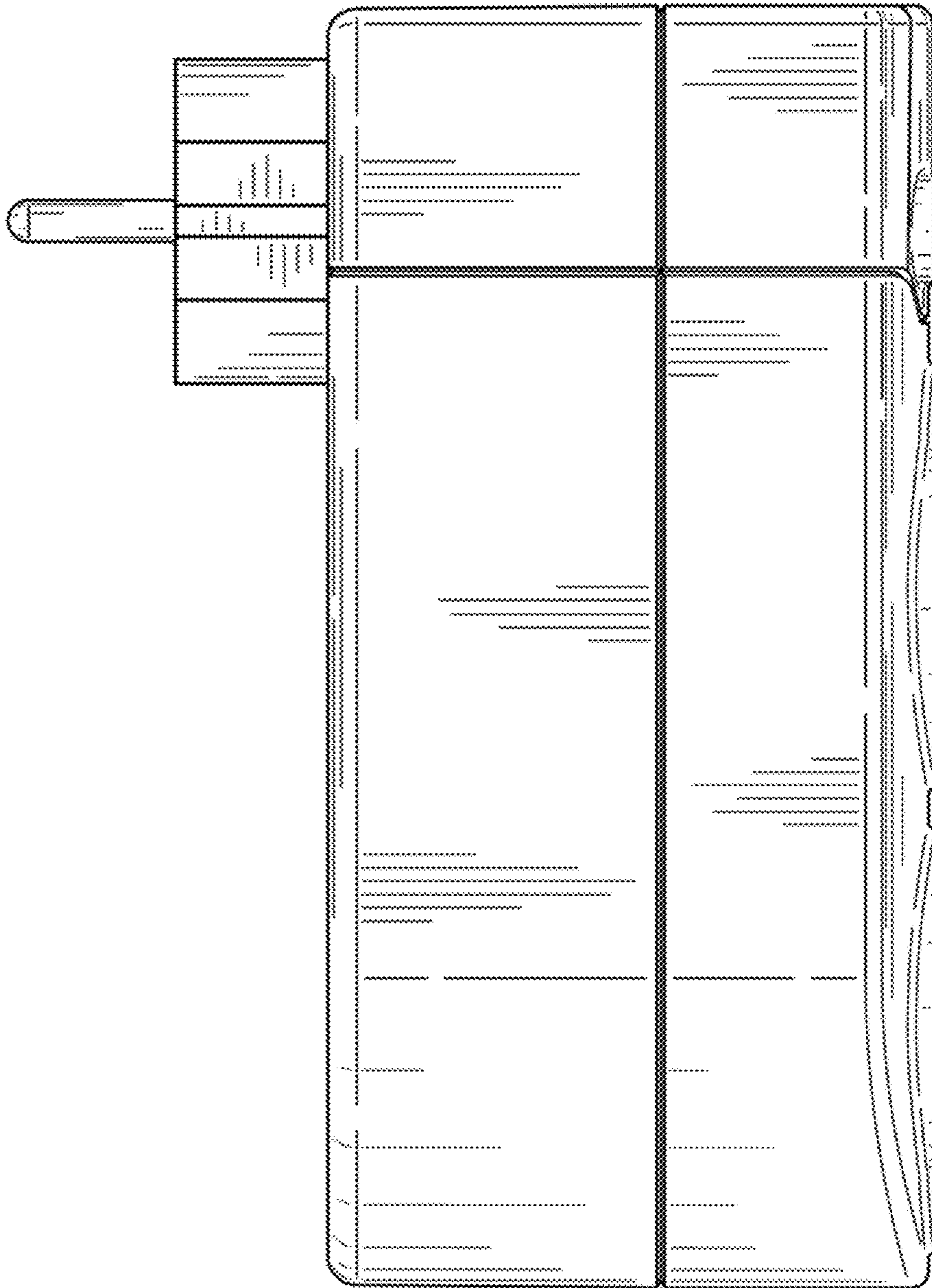

FIG. 26

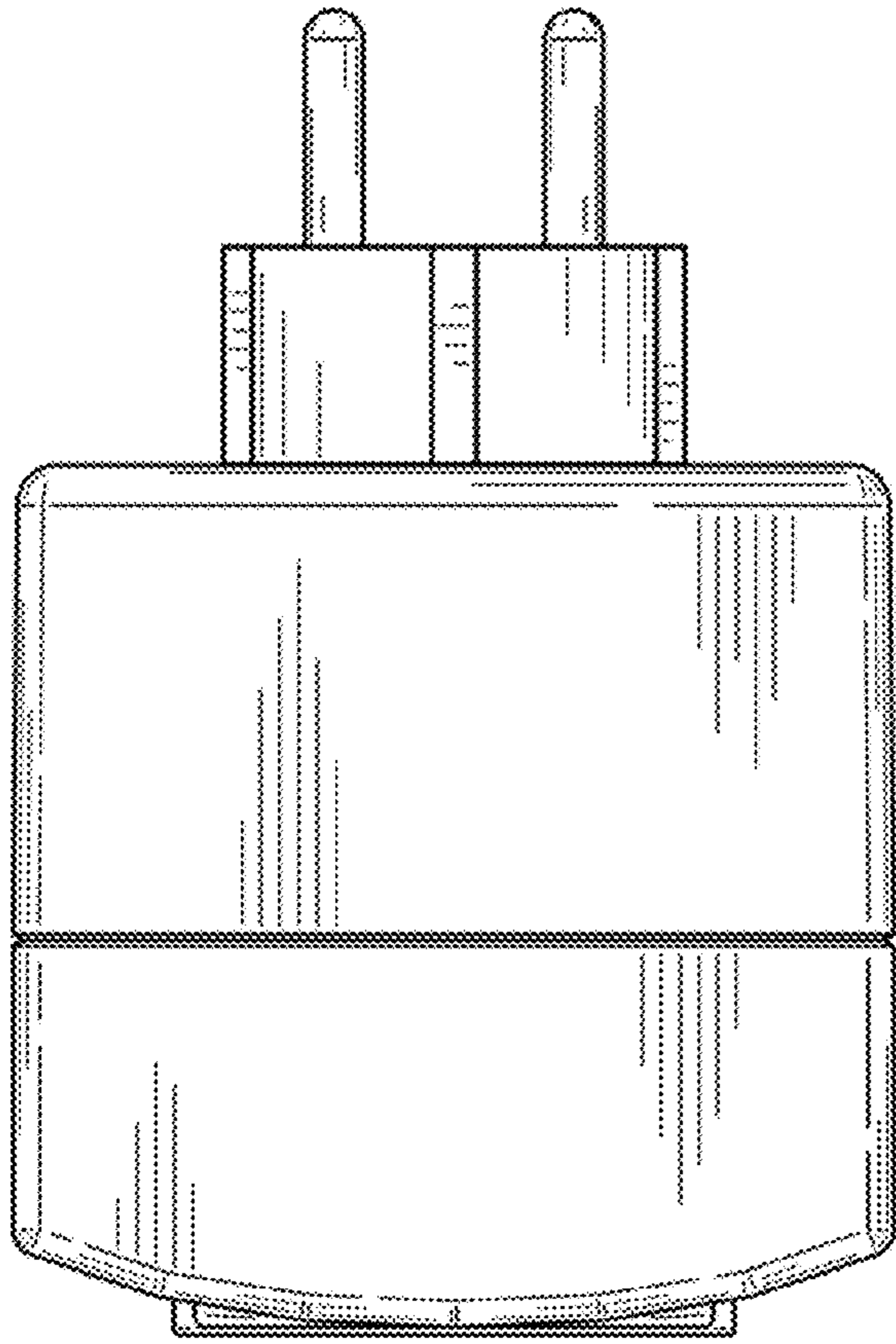

FIG. 27

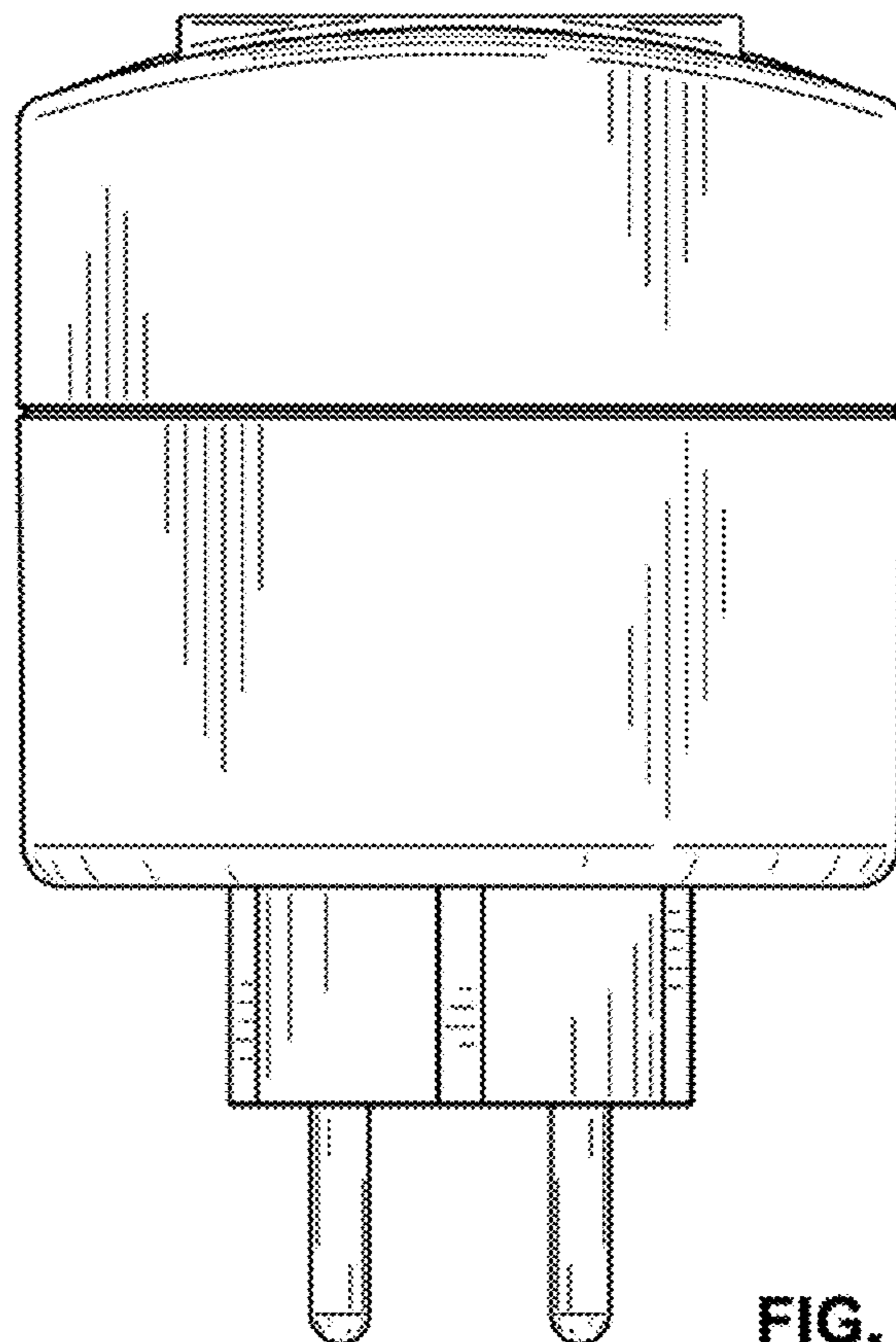

FIG. 28