



US00D894738S

(12) **United States Design Patent** (10) **Patent No.:** **US D894,738 S**
Hexemer et al. (45) **Date of Patent:** **** Sep. 1, 2020**

(54) **CAP FOR BOTTLE FOR BEAUTY CARE PRODUCTS**

(71) Applicant: **The Procter & Gamble Company**, Cincinnati, OH (US)

(72) Inventors: **Matthew Gerald Hexemer**, Minesing (CA); **Borys Jerzy Chylinski**, Toronto (CA); **Jason Dean Tiernan**, Brooklyn, NY (US)

(73) Assignee: **The Procter & Gamble Company**, Cincinnati, OH (US)

(**) Term: **15 Years**

(21) Appl. No.: **29/645,889**

(22) Filed: **Apr. 30, 2018**

(51) **LOC (12) Cl.** **09-07**

(52) **U.S. Cl.**
USPC **D9/456**

(58) **Field of Classification Search**
USPC D7/387, 391, 392, 392.1, 393, 396.1, D7/396.2, 398, 900; D9/434, 435, 439,
(Continued)

(56) **References Cited**

U.S. PATENT DOCUMENTS

D28,413 S * 3/1898 Taite D9/504
D129,943 S * 10/1941 Petzold D28/85
(Continued)

FOREIGN PATENT DOCUMENTS

JP 2015104490 A * 6/2015
JP 2015119900 A * 7/2015

OTHER PUBLICATIONS

Golden Aura Skin Treatment: Site Visited [May 9, 2019]. Available from Internet URL: [https://www.oly.com/en-us/skin-care-products/oly-golden-aura-youth-essence-13-oz.*

Primary Examiner — Catherine S Posthauer
(74) *Attorney, Agent, or Firm* — John G. Powell

(57) **CLAIM**

The ornamental design for a cap for bottle for beauty care products, as shown and described.

DESCRIPTION

FIG. 1 is a perspective view of a first embodiment of a cap for bottle for beauty care products, embodying our new design;
FIG. 2 is a front view thereof;
FIG. 3 is a left-side view thereof;
FIG. 4 is a back view thereof;
FIG. 5 is a right-side view thereof;
FIG. 6 is a top view thereof;
FIG. 7 is a bottom view thereof;
FIG. 8 is a perspective view of a second embodiment of a cap for bottle for beauty care products, embodying our new design;
FIG. 9 is a front view thereof;
FIG. 10 is a left-side view thereof;
FIG. 11 is a back view thereof;
FIG. 12 is a right-side view thereof;
FIG. 13 is a top view thereof;
FIG. 14 is a bottom view thereof;
FIG. 15 is a perspective view of a third embodiment of a cap for bottle for beauty care products, embodying our new design;
FIG. 16 is a front view thereof;
FIG. 17 is a left-side view thereof;
FIG. 18 is a back view thereof;
FIG. 19 is a right-side view thereof;
FIG. 20 is a top view thereof;
FIG. 21 is a bottom view thereof;
FIG. 22 is a perspective view of a fourth embodiment of a cap for bottle for beauty care products, embodying our new design;
FIG. 23 is a front view thereof;
FIG. 24 is a left-side view thereof;
FIG. 25 is a back view thereof;
FIG. 26 is a right-side view thereof;
(Continued)

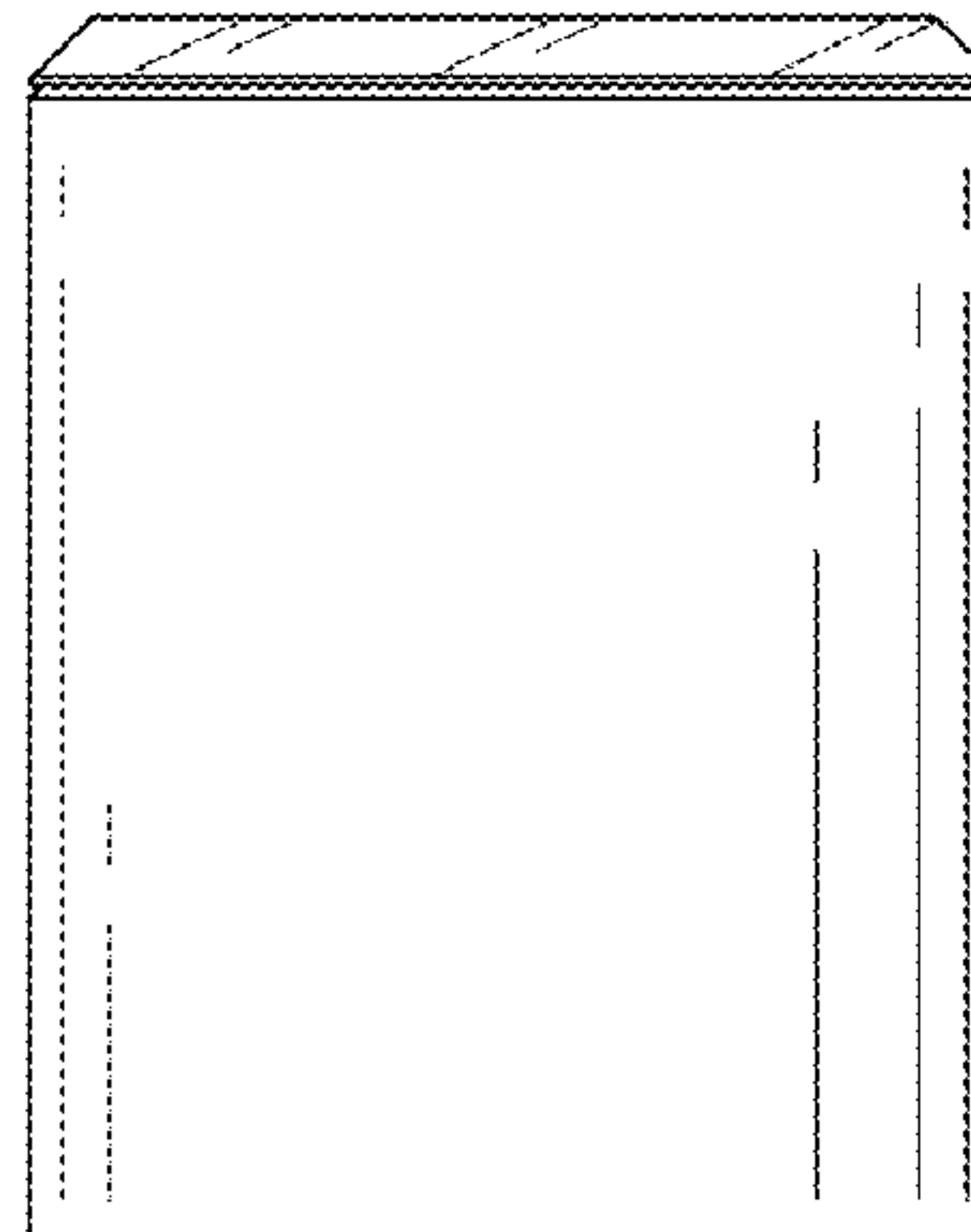
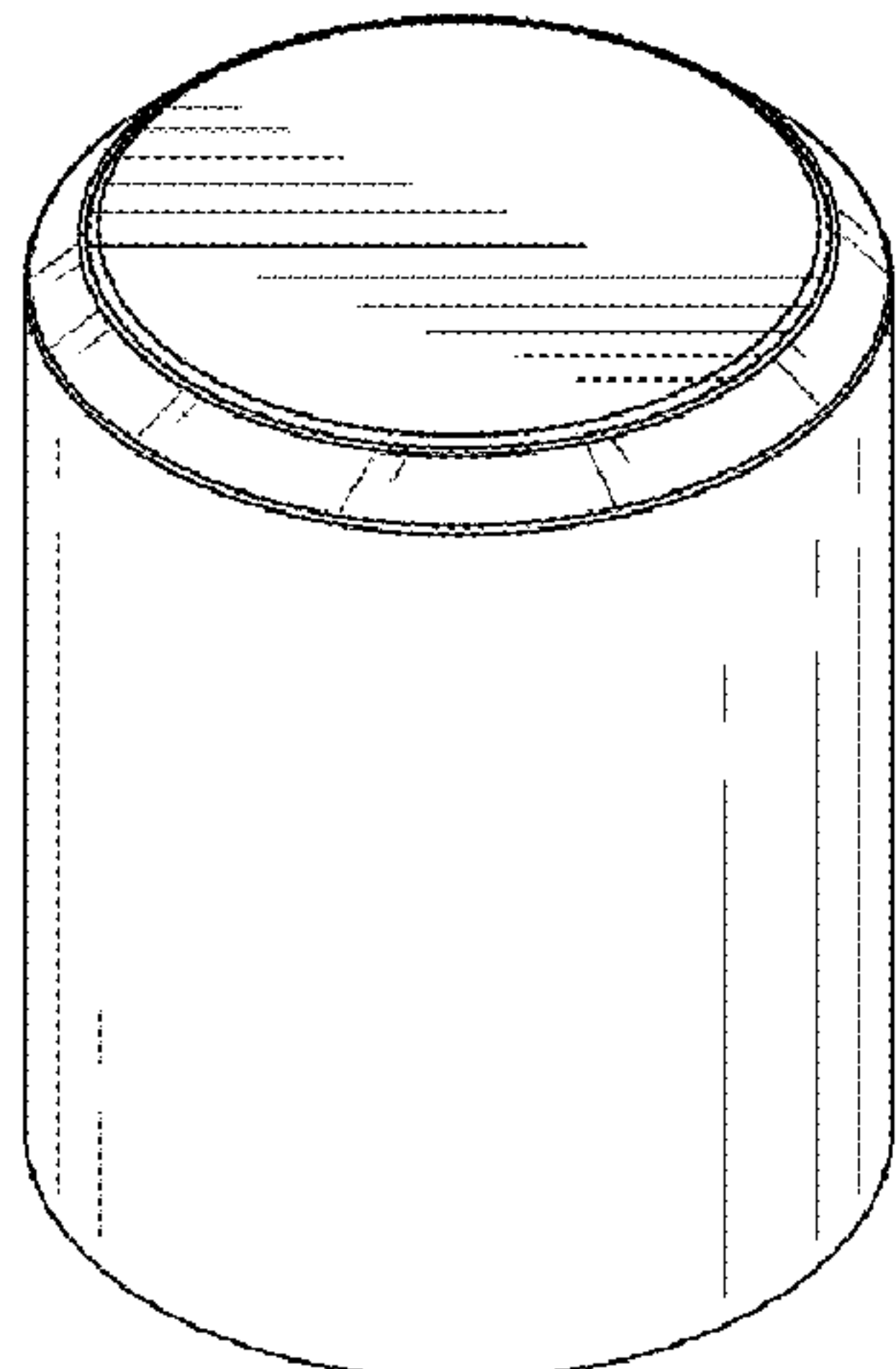

FIG. 27 is a top view thereof;
 FIG. 28 is a bottom view thereof;
 FIG. 29 is a perspective view of a fifth embodiment of a cap for bottle for beauty care products, embodying our new design;
 FIG. 30 is a front view thereof;
 FIG. 31 is a left-side view thereof;
 FIG. 32 is a back view thereof;
 FIG. 33 is a right-side view thereof;
 FIG. 34 is a top view thereof;
 FIG. 35 is a bottom view thereof;
 FIG. 36 is a perspective view of a sixth embodiment of a cap for bottle for beauty care products, embodying our new design;
 FIG. 37 is a front view thereof;
 FIG. 38 is a left-side view thereof;
 FIG. 39 is a back view thereof;
 FIG. 40 is a right-side view thereof;
 FIG. 41 is a top view thereof;
 FIG. 42 is a bottom view thereof;
 FIG. 43 is a perspective view of a seventh embodiment of a cap for bottle for beauty care products, embodying our new design, shown in a position of use with an exemplary bottle;
 FIG. 44 is a front view thereof;
 FIG. 45 is a left-side view thereof;
 FIG. 46 is a back view thereof;
 FIG. 47 is a right-side view thereof;
 FIG. 48 is a top view thereof; and,
 FIG. 49 is a bottom view thereof.
 The broken lines are shown for the purpose of illustrating both parts of the article as well as environmental subject matter of an exemplary bottle and form no part of the claimed design.

1 Claim, 8 Drawing Sheets

(58) **Field of Classification Search**

USPC D9/445, 446, 447, 448, 449, 452, 453,
 D9/454, 442, 695-699, 702-715,
 D9/723-729, 425, 428, 500-505, 516,
 D9/529, 530, 537, 538, 541, 546, 549,
 D9/566, 569, 570, 692, 694, 745, 746,
 D9/774; D19/96, 162, 163, 187, 194;
 D23/259, 260, 261; D24/112, 127, 194,
 D24/196, 197, 199, 224; D28/4, 73, 76,
 D28/78, 82

CPC B65D 75/5883; B65D 41/3414; B65D
 41/00; B65D 41/3447; B65D 2213/00;
 B65D 2256/023; B65D 81/3272; B65D
 85/12; B65D 23/065; B65D 47/066;
 A45D 2200/05; A45D 2200/051; A45D
 34/00; A45D 34/02; A45D 40/40; A45D
 40/0068; A45D 40/0073; A45D 2034/007;
 A45D 40/00; A45F 3/16; A47G 19/2266;
 A47G 19/2272

See application file for complete search history.

(56)

References Cited

U.S. PATENT DOCUMENTS

3,934,745	A *	1/1976	Lovell	B65D 41/185 215/224
D327,808	S *	7/1992	Kline	D7/391
D352,896	S *	11/1994	Jones	D9/503
D437,556	S *	2/2001	Holliday	D9/436
D443,040	S *	5/2001	Fabian	D23/249
D477,225	S *	7/2003	Pinnavaia	D9/435
D484,644	S *	12/2003	Noh	D28/76
D485,016	S *	1/2004	Noh	D28/76
D485,017	S *	1/2004	Noh	D28/76
D492,596	S *	7/2004	Miceli	D9/435
D512,914	S *	12/2005	Moretti	D9/454
D531,036	S *	10/2006	Bried	D9/504
D630,944	S *	1/2011	Kawamura	D9/447
D633,644	S *	3/2011	Sprengers	D26/89
D649,880	S *	12/2011	Smith, III	D9/500
D678,771	S *	3/2013	Kawamura	D9/452
D695,613	S *	12/2013	Miranda De Araujo	D9/449
D697,400	S *	1/2014	Bragalone	D9/416
D703,053	S *	4/2014	Park	D9/503
D711,250	S *	8/2014	Henriksson	D9/504
D715,156	S *	10/2014	Park	D9/688
D733,967	S *	7/2015	Schlatter	D28/85
D741,603	S *	10/2015	Mehta	D4/116
D756,779	S *	5/2016	Kang	D9/454
D769,067	S *	10/2016	Cheung	D7/399
D822,282	S *	7/2018	Montoli	A45D 33/00 D28/82
D825,334	S *	8/2018	Ristich	D9/454
2006/0000841	A1 *	1/2006	Smay	B65D 1/0223 220/735
2017/0303661	A1 *	10/2017	Salciarini	A45D 40/0068
2018/0132592	A1 *	5/2018	Chung	A45D 33/006
2018/0242712	A1 *	8/2018	Salciarini	A45D 40/0068

* cited by examiner

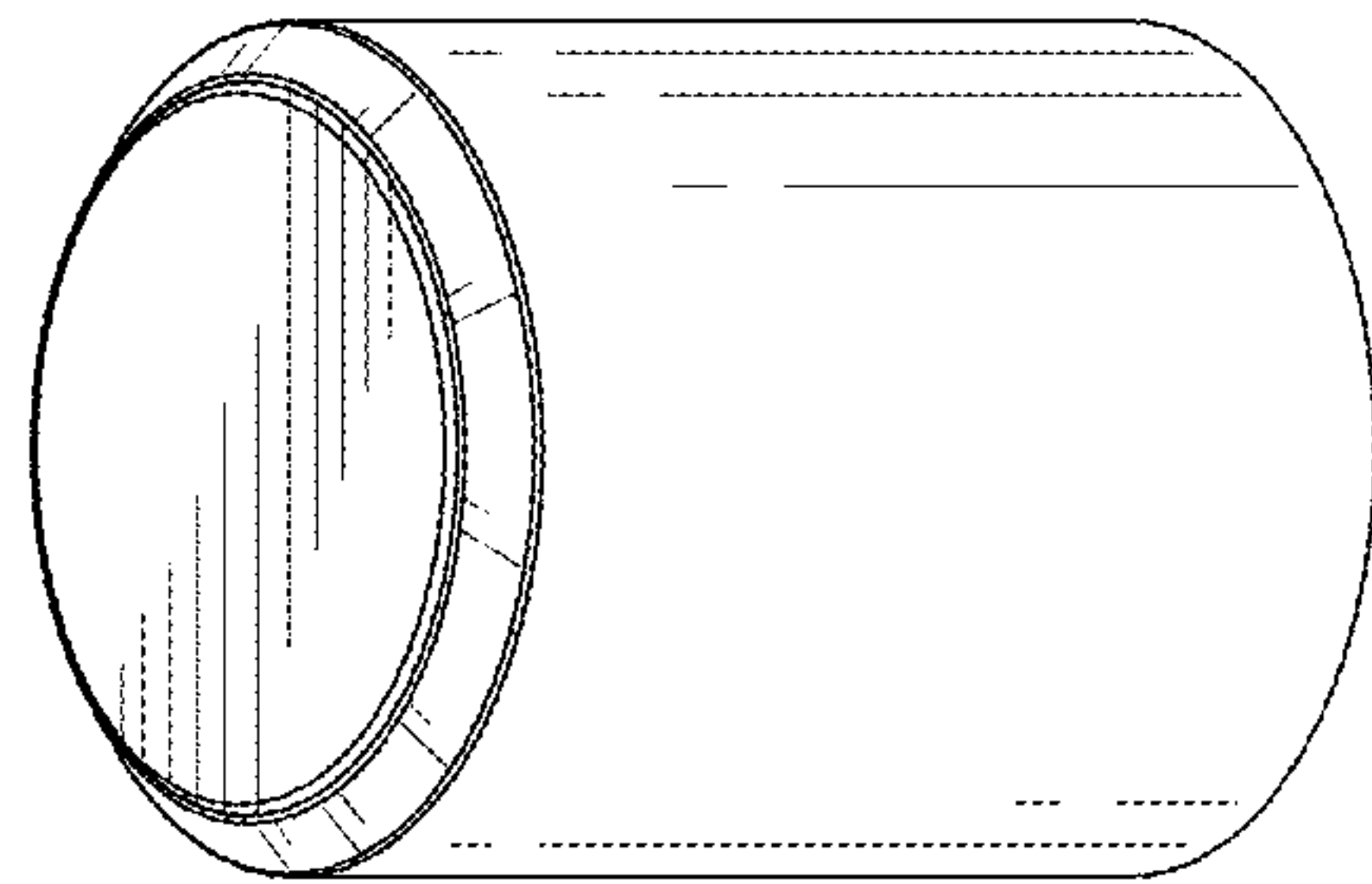

FIG. 1

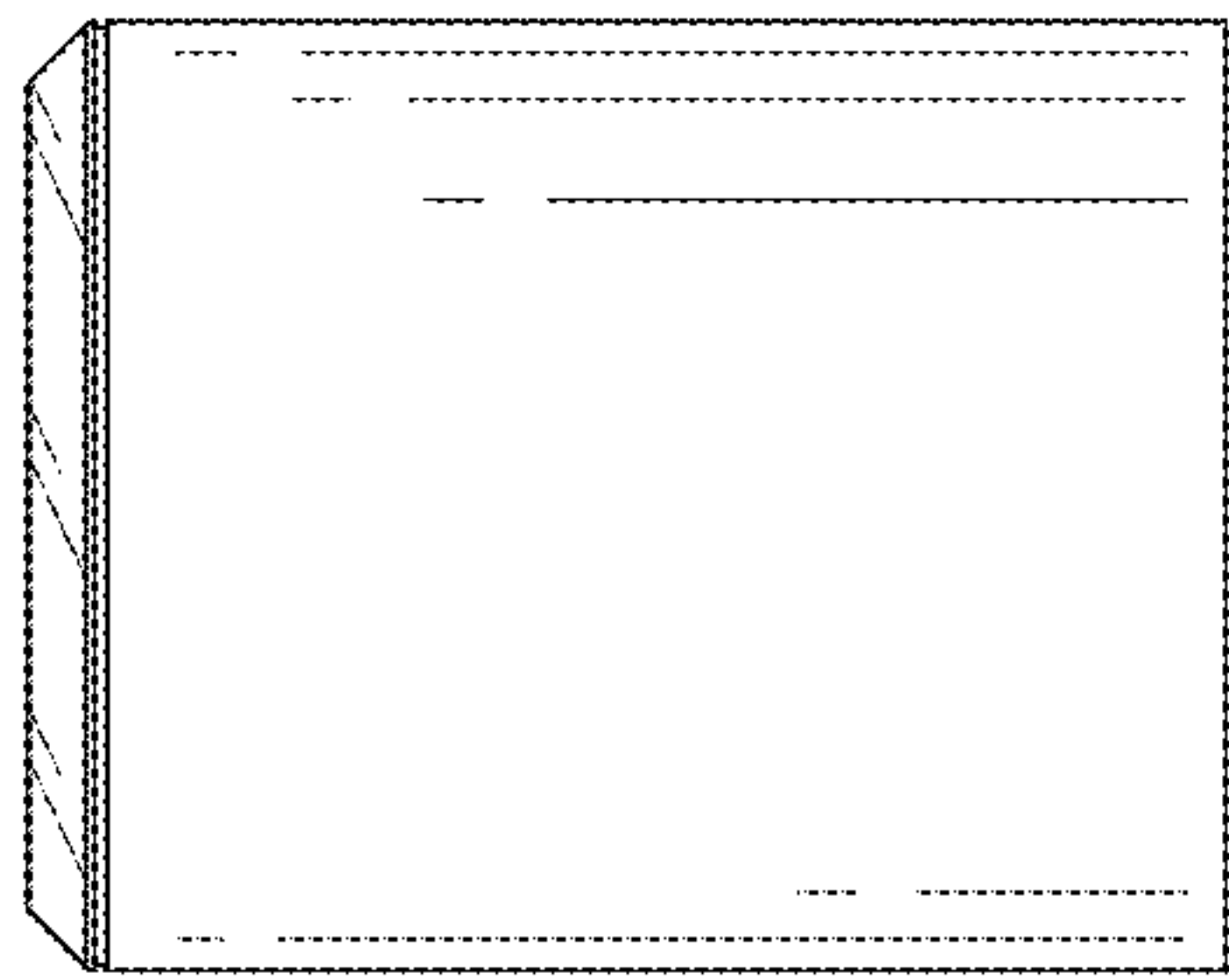

FIG. 2

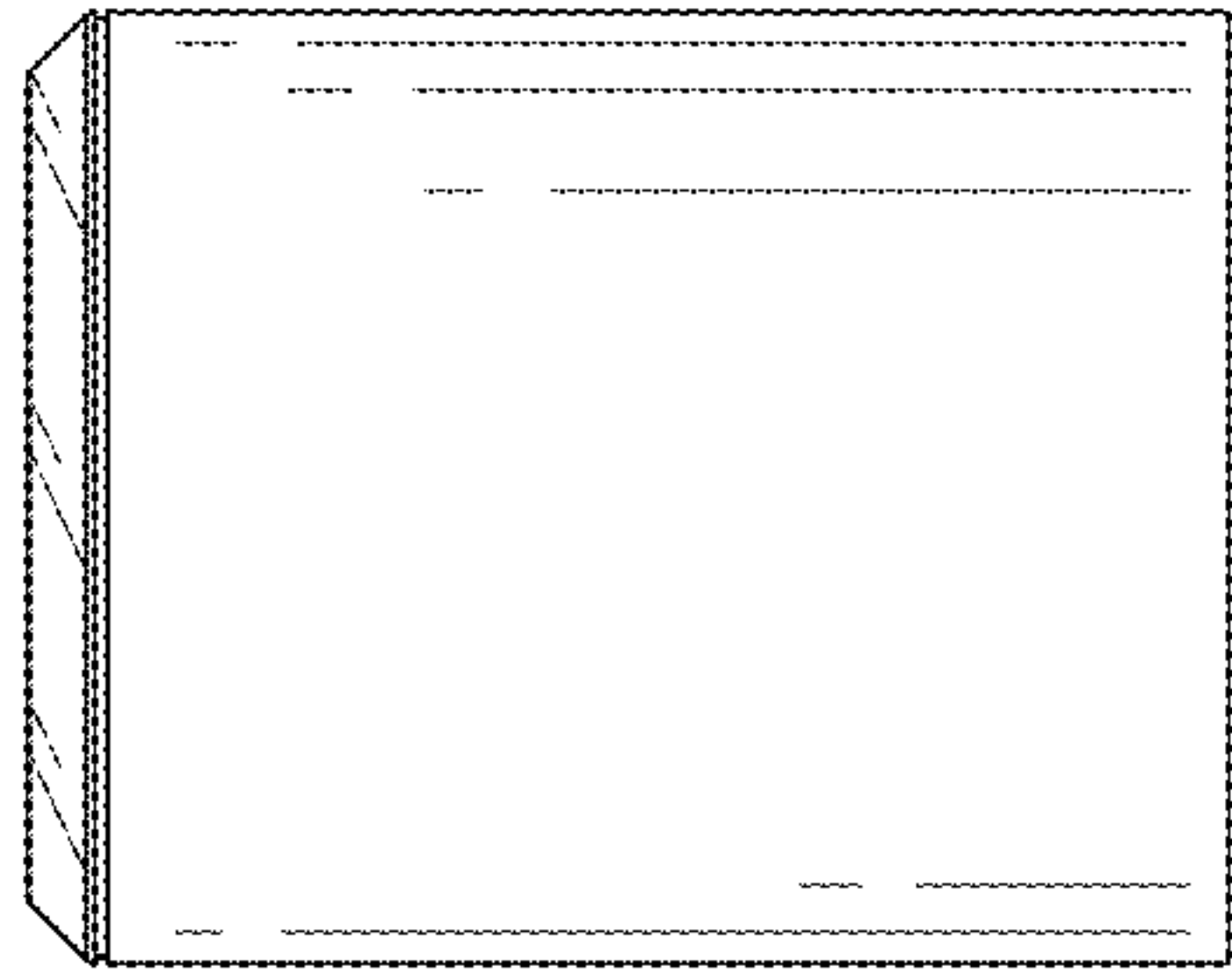

FIG. 3

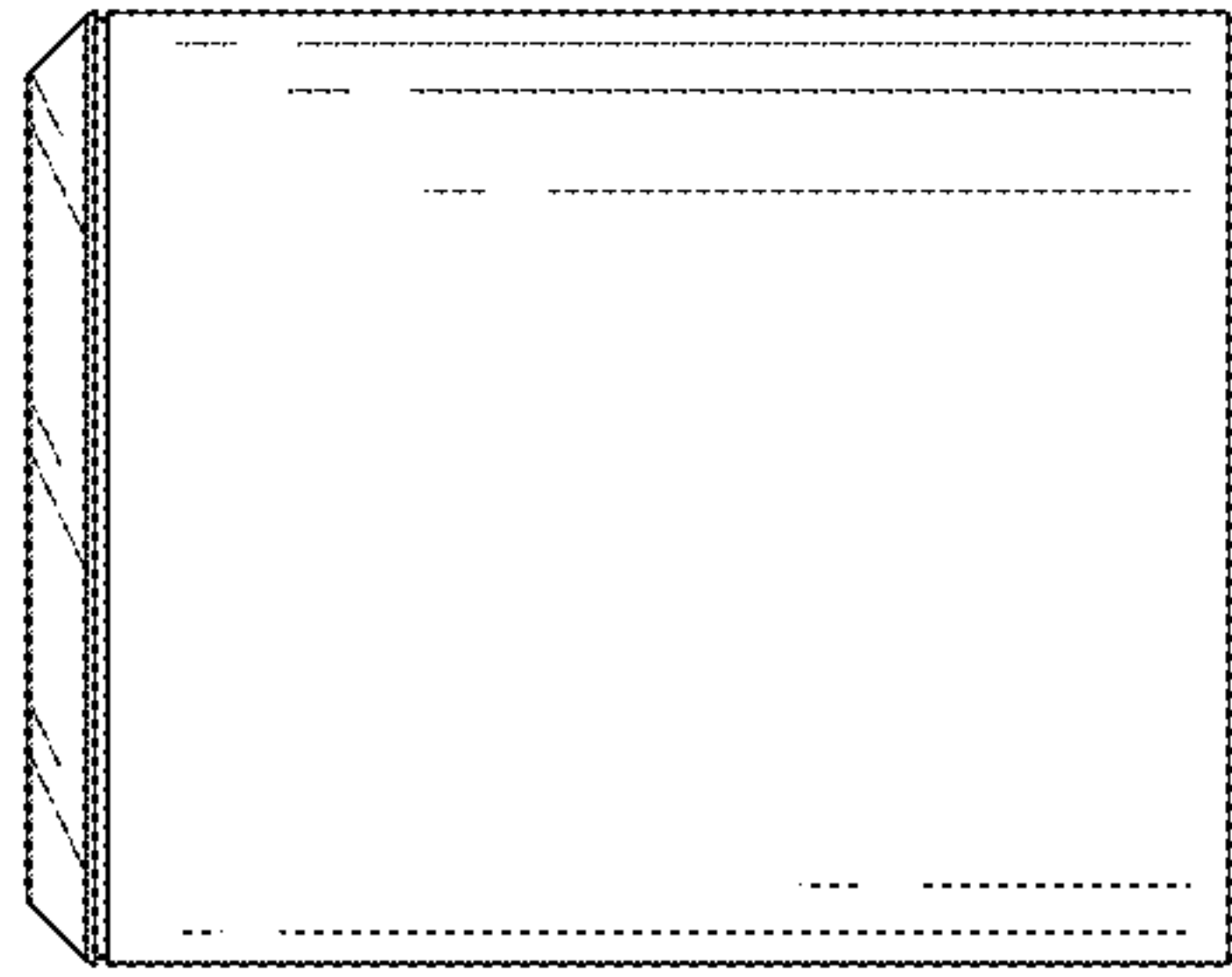

FIG. 4

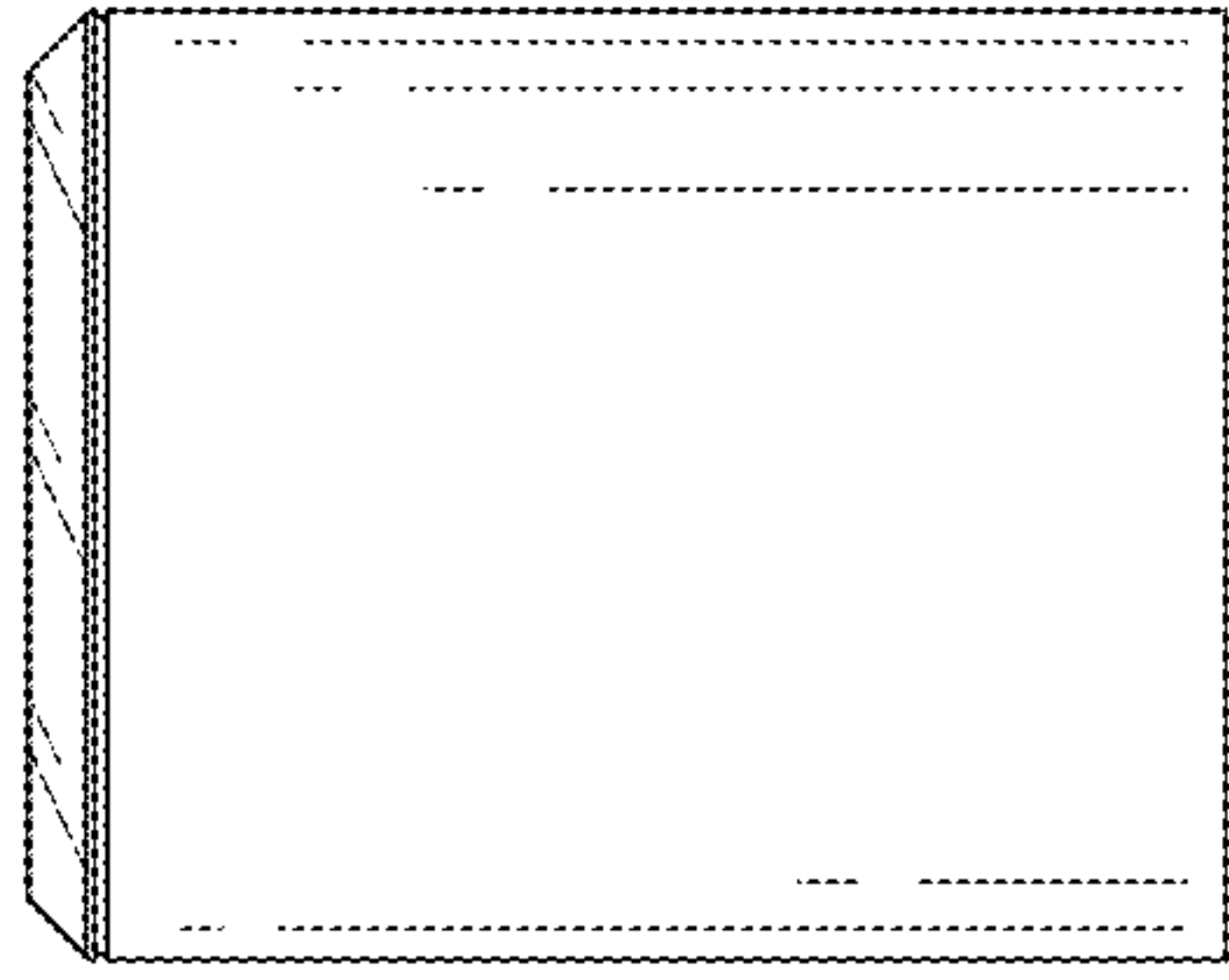

FIG. 5

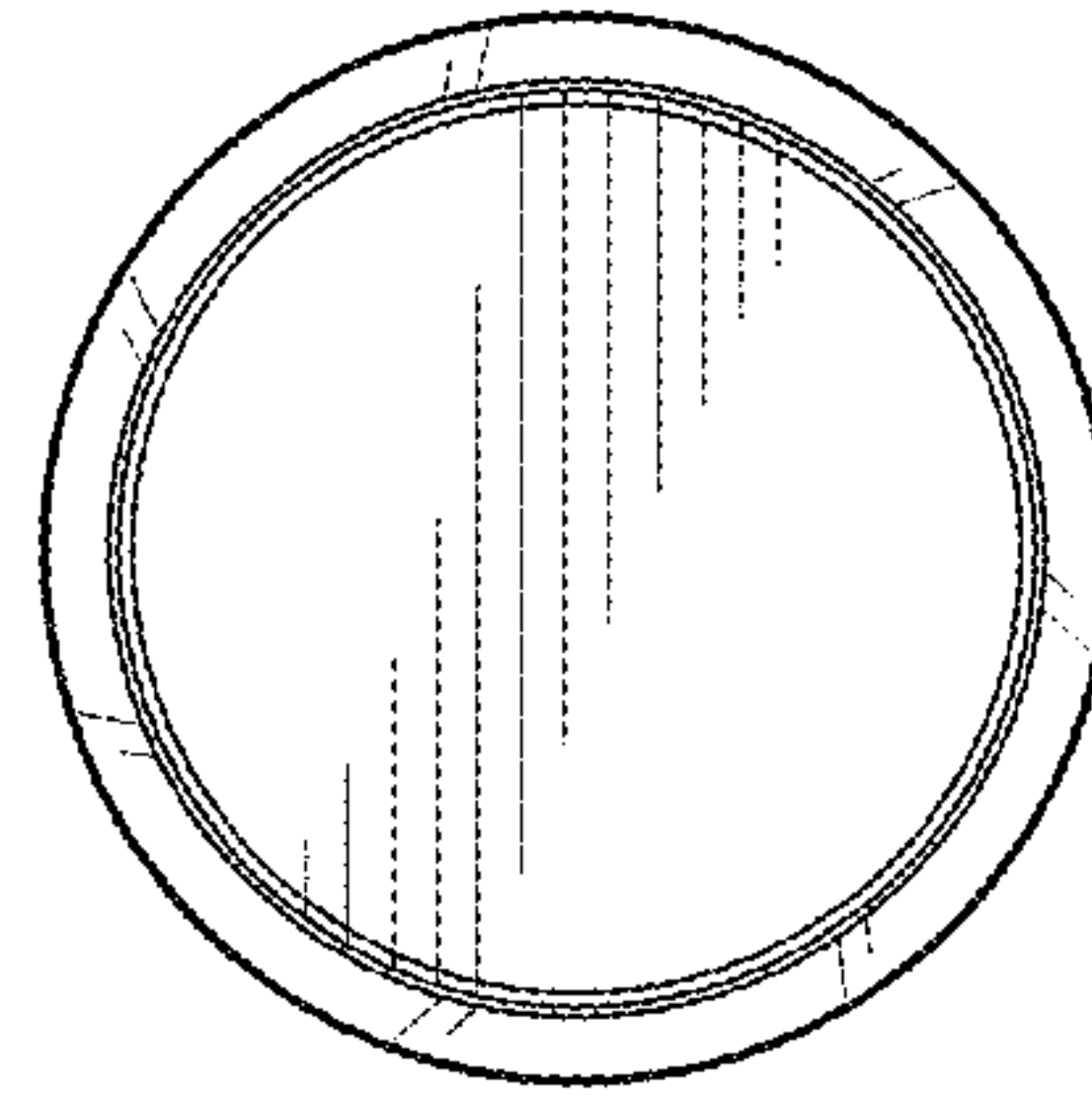

FIG. 6

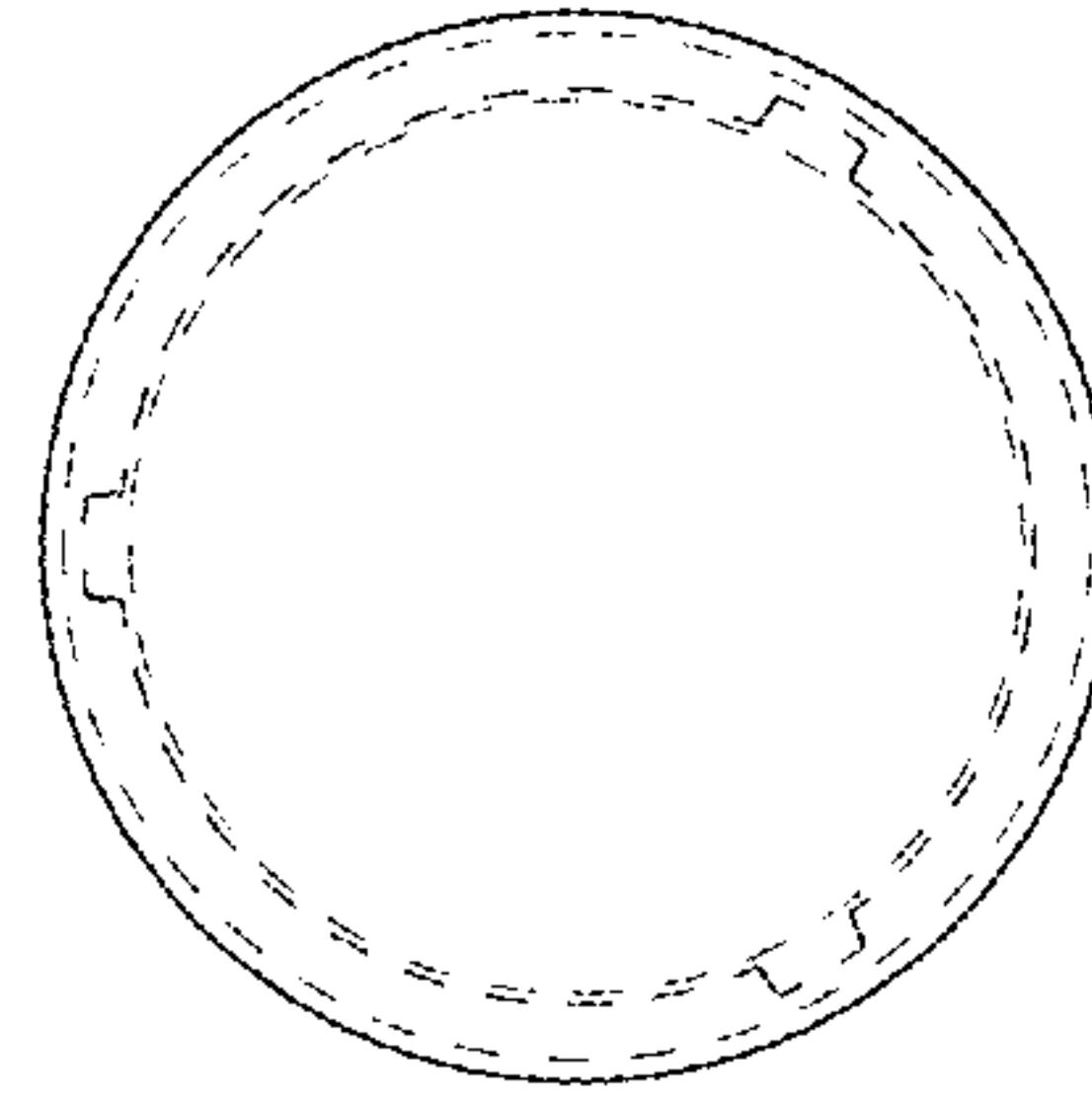

FIG. 7

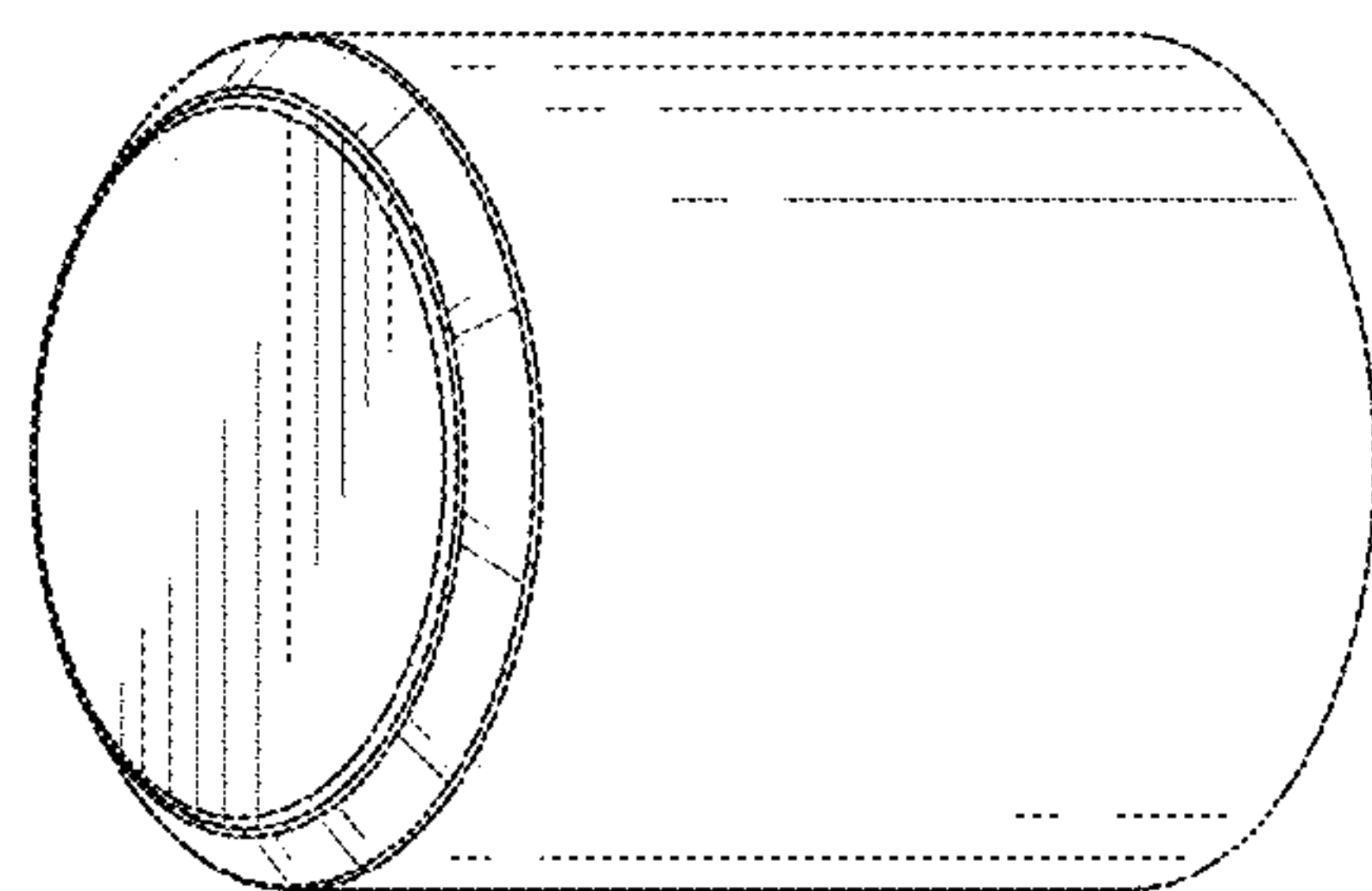

FIG. 8

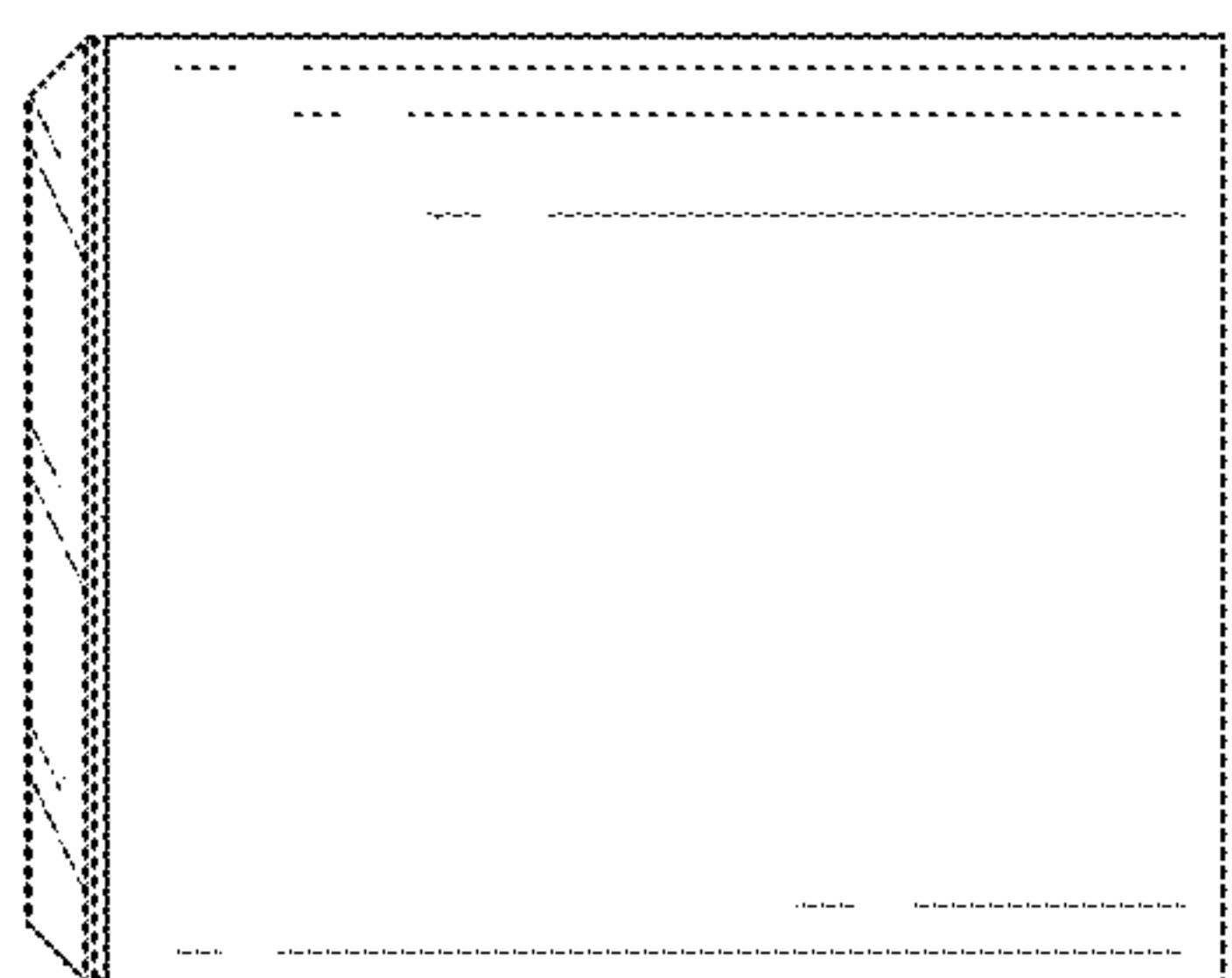

FIG. 9

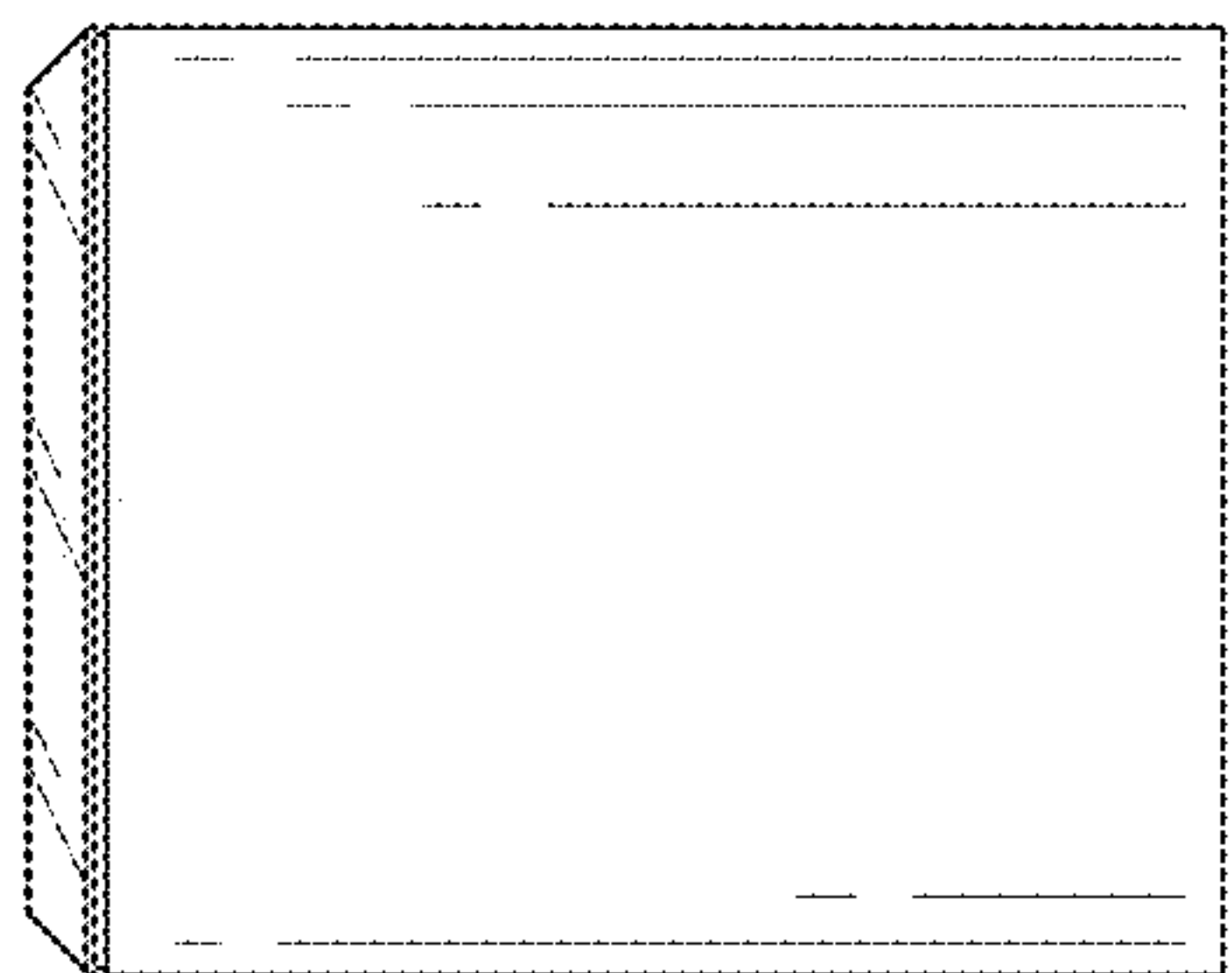

FIG. 10

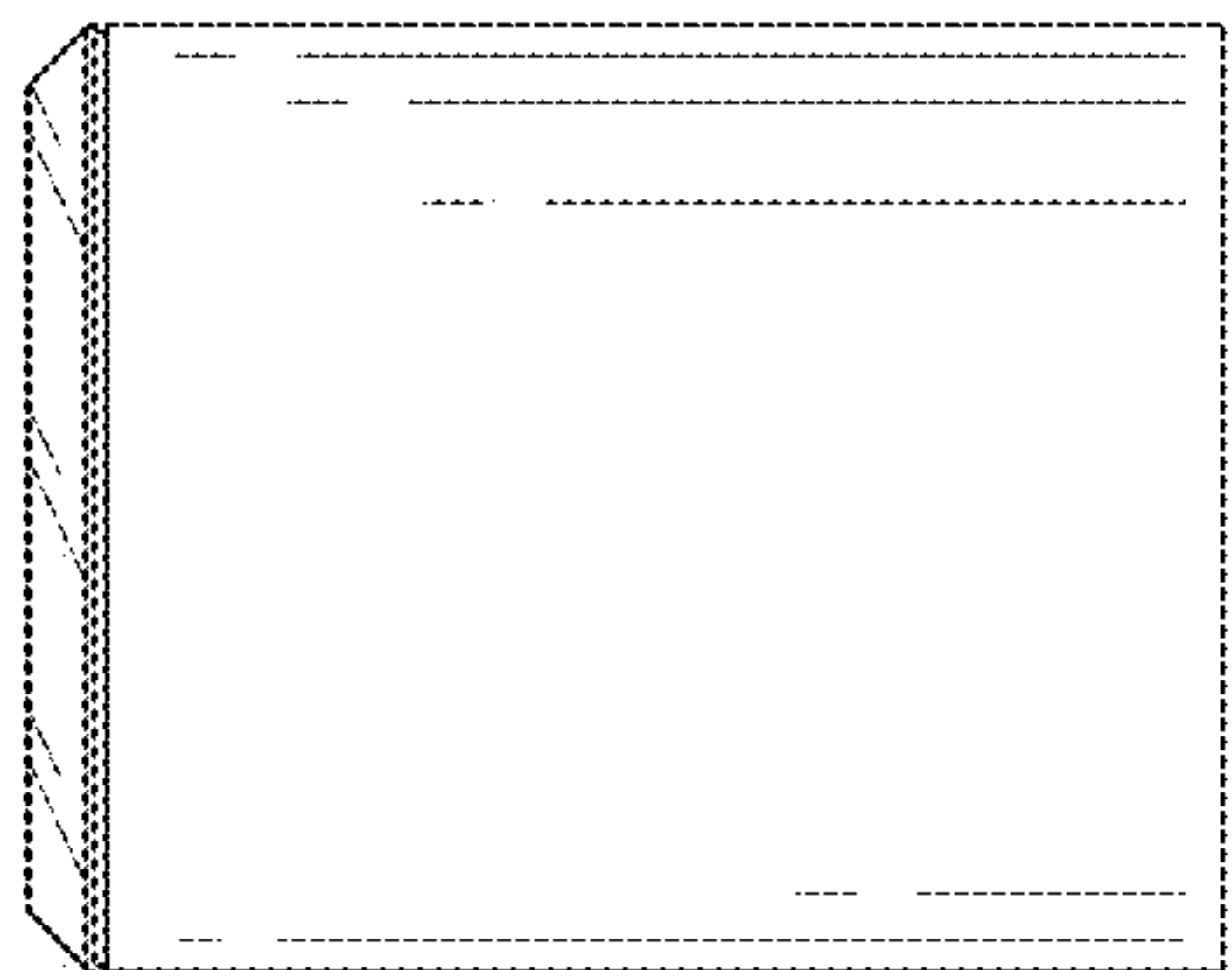

FIG. 11

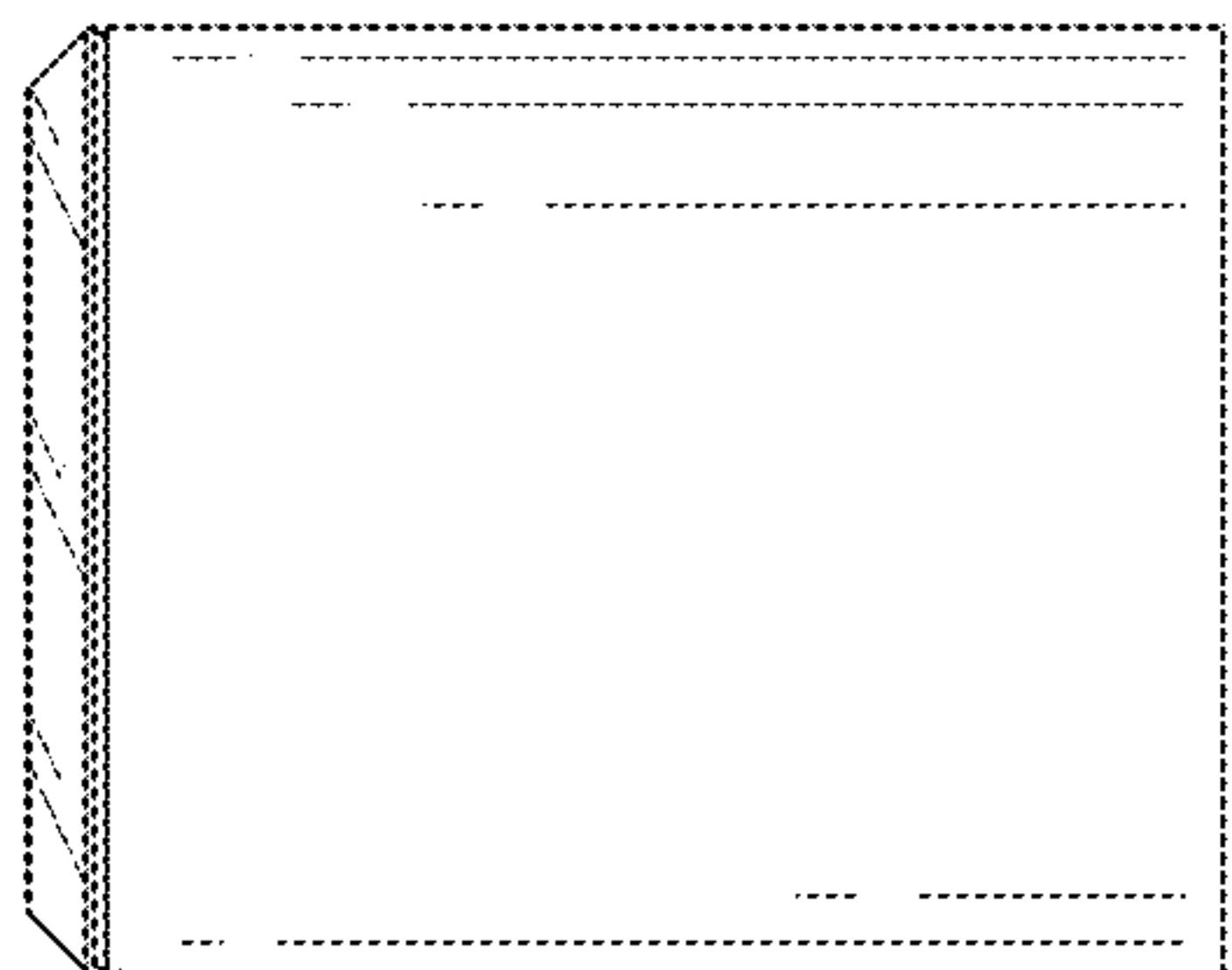

FIG. 12

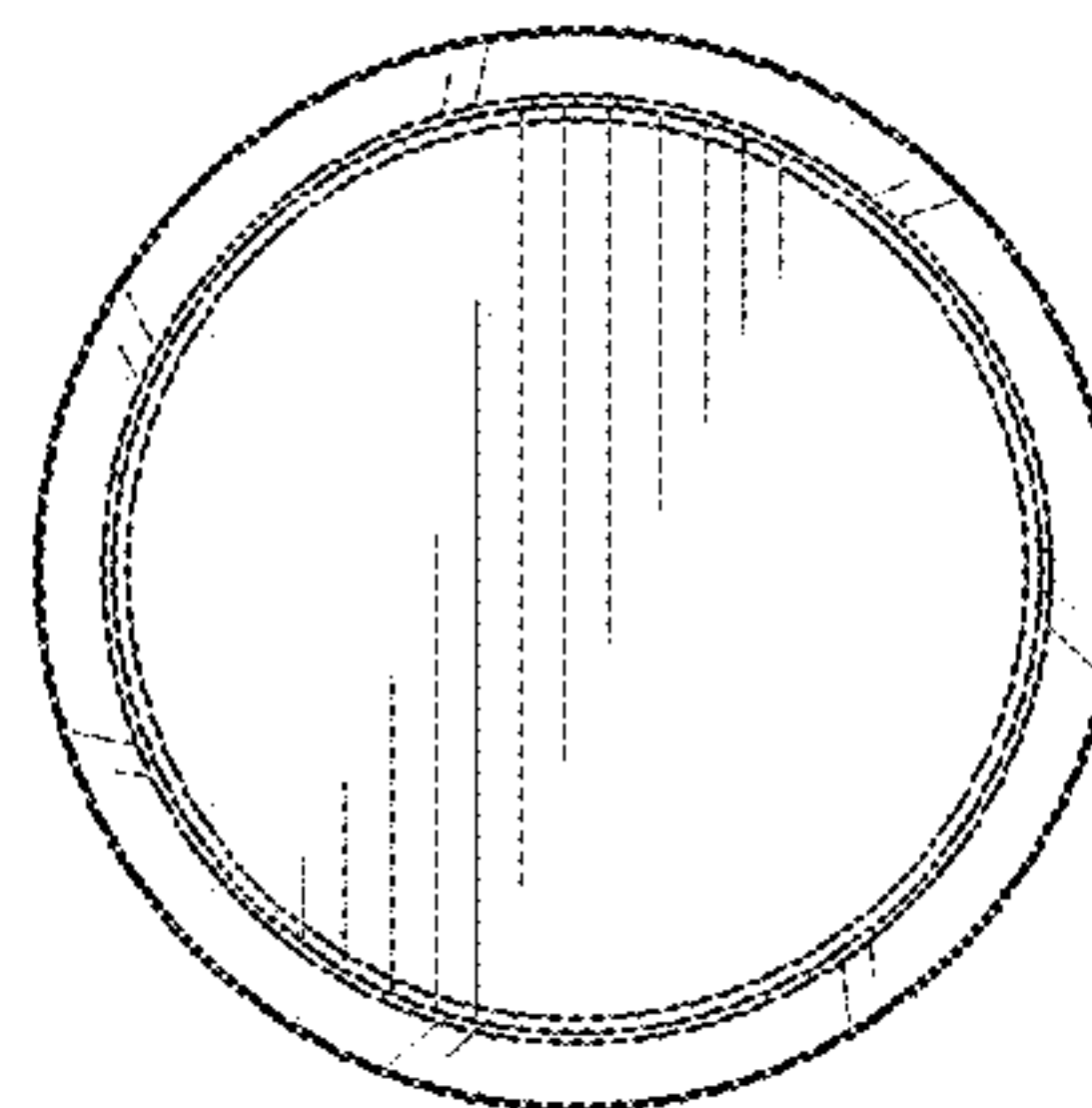

FIG. 13

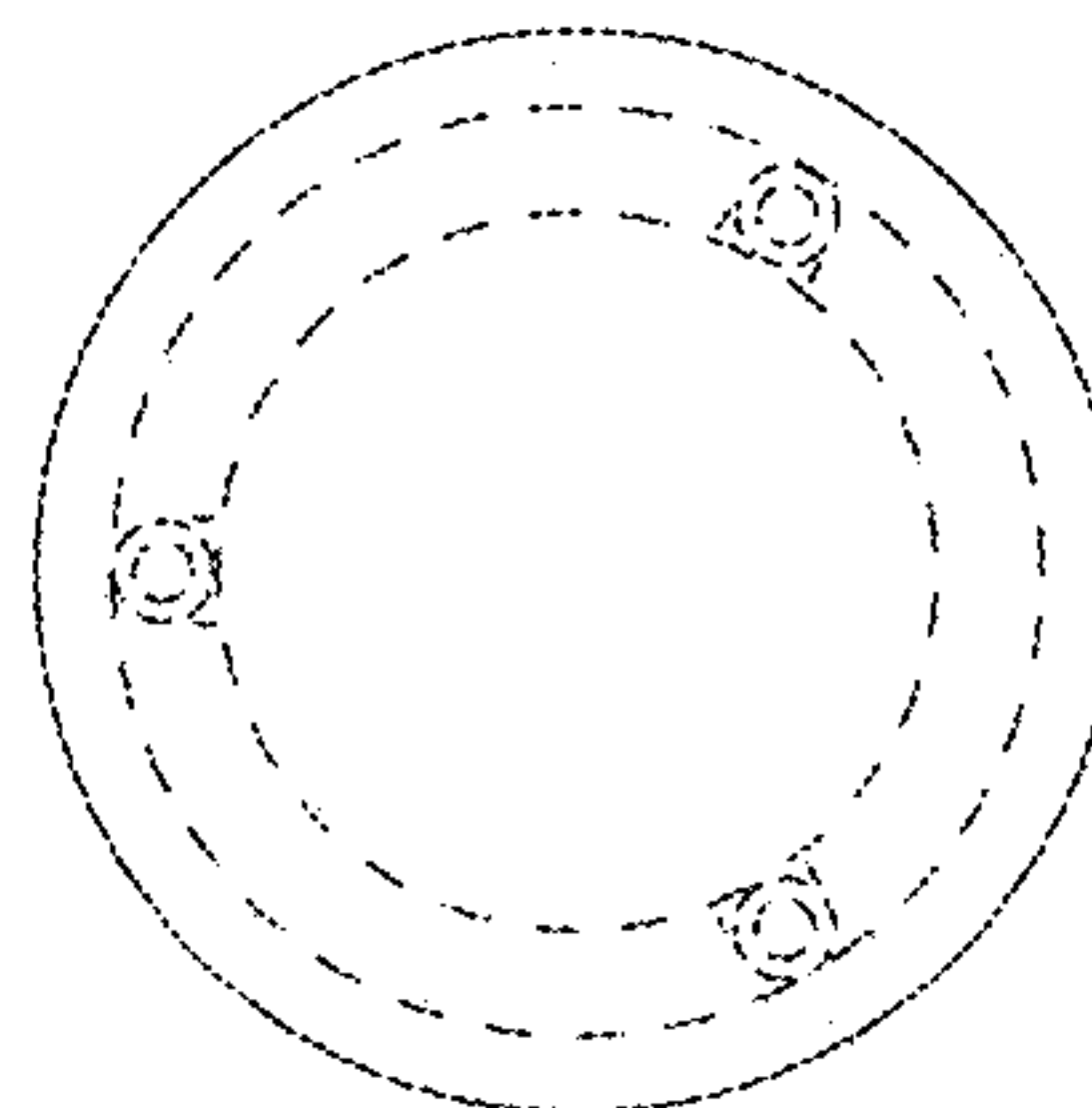

FIG. 14

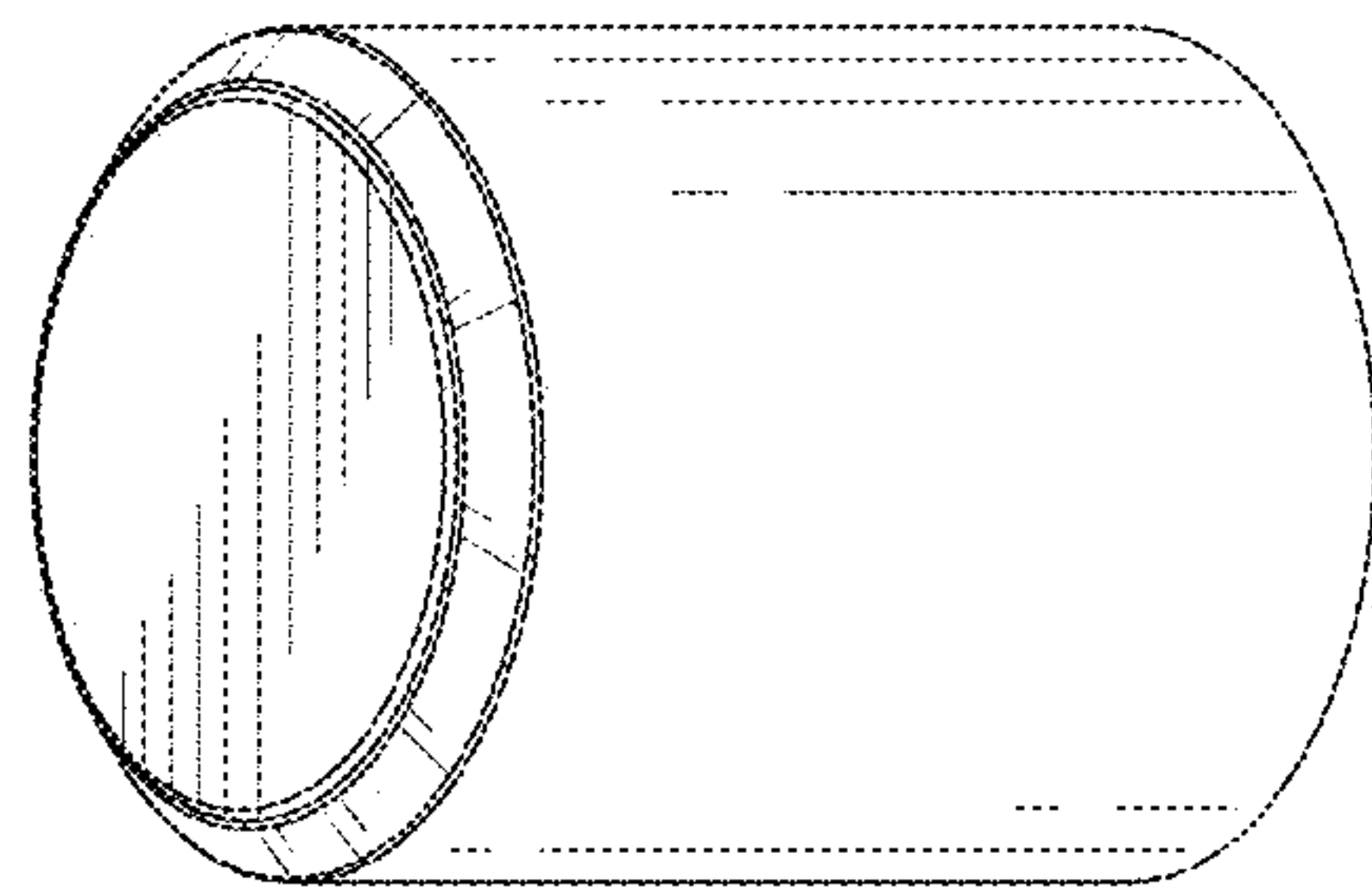

FIG. 15

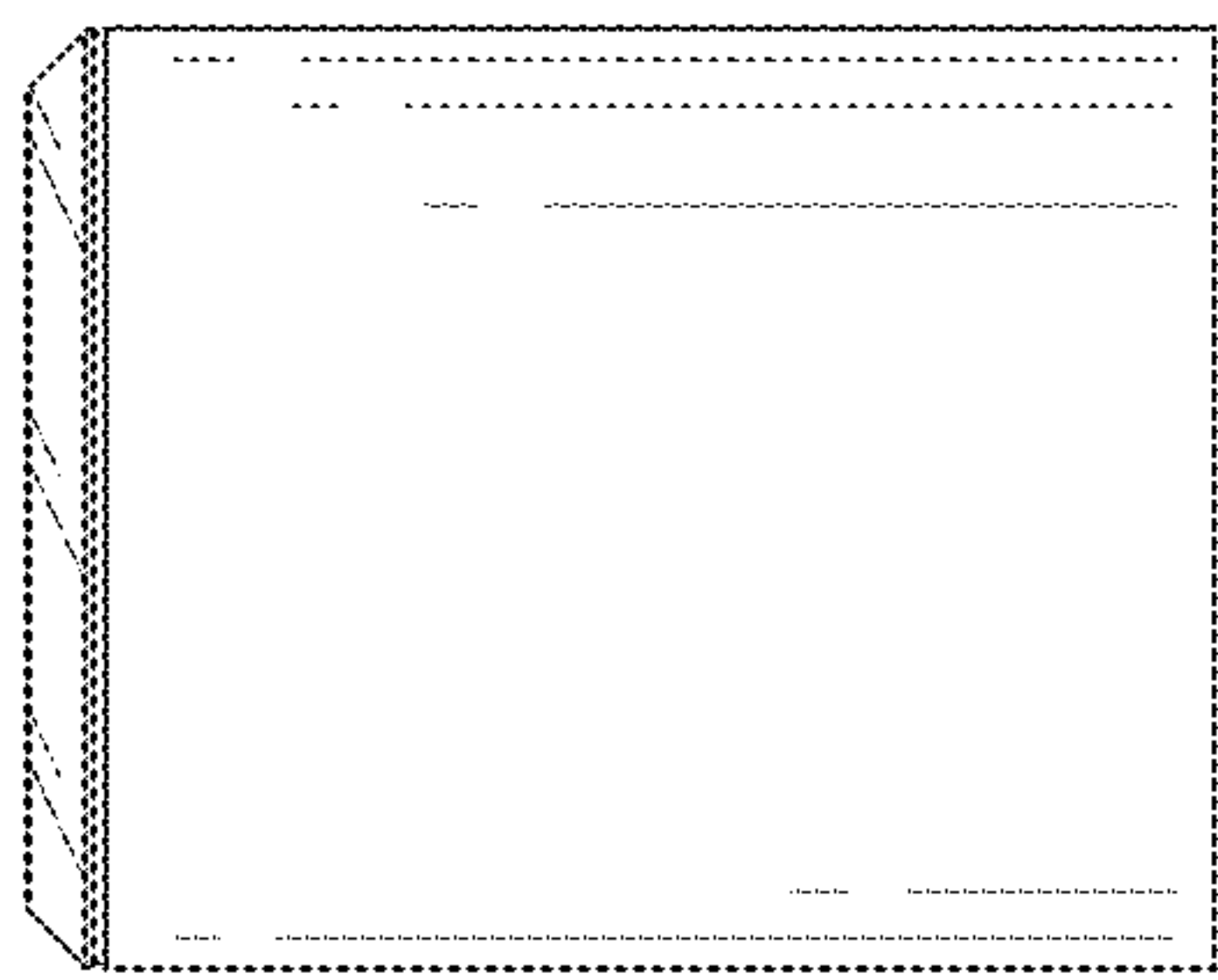

FIG. 16

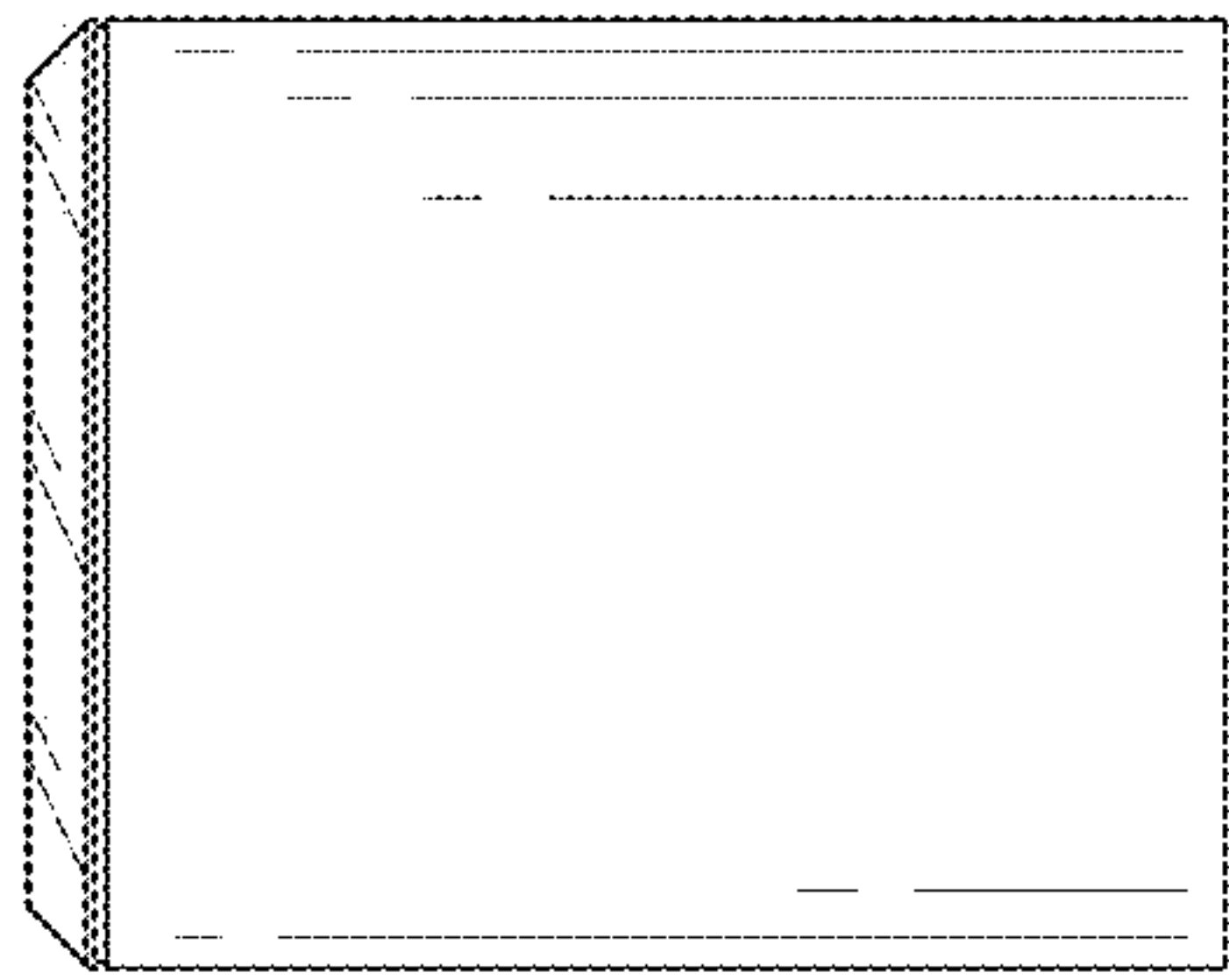

FIG. 17

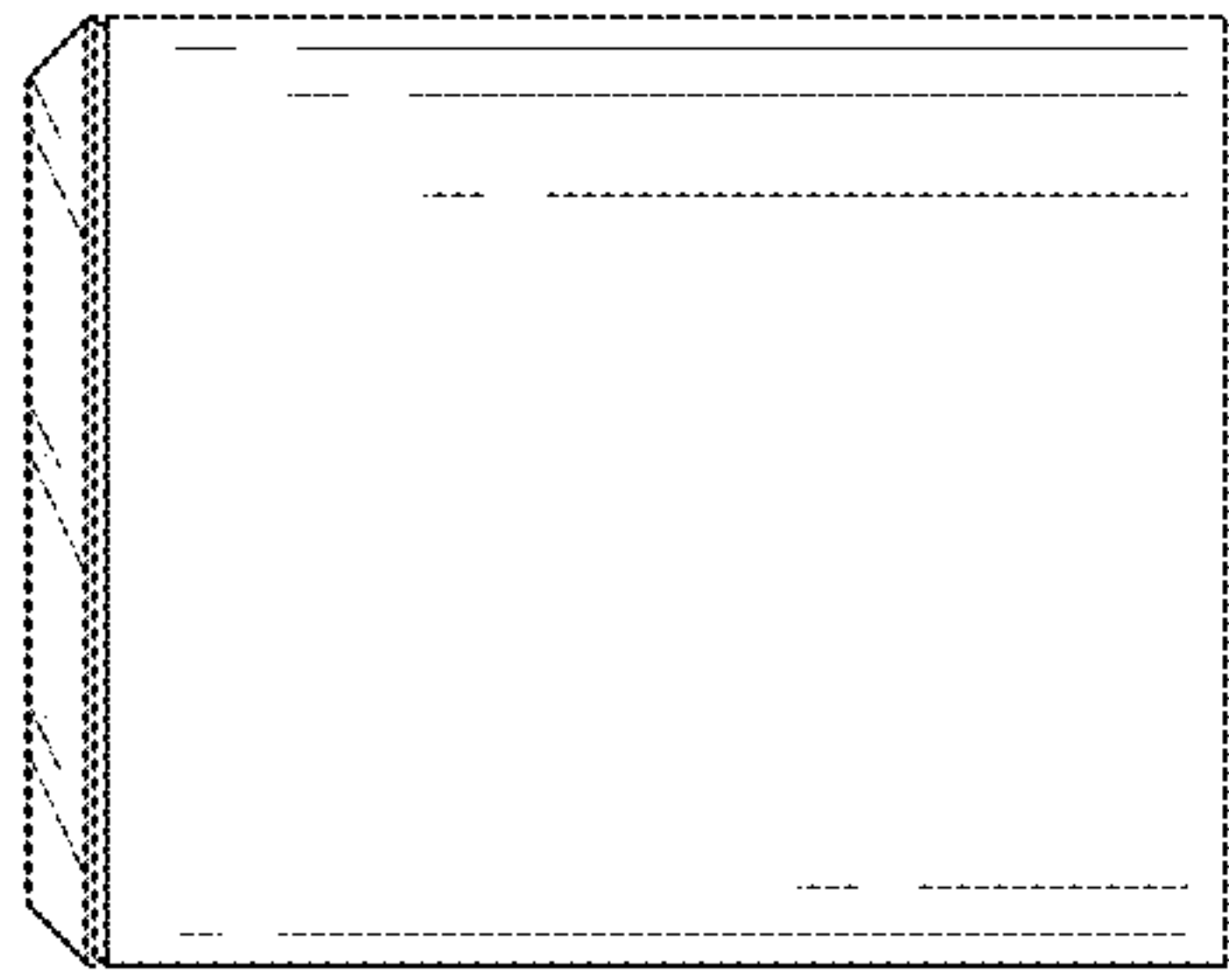

FIG. 18

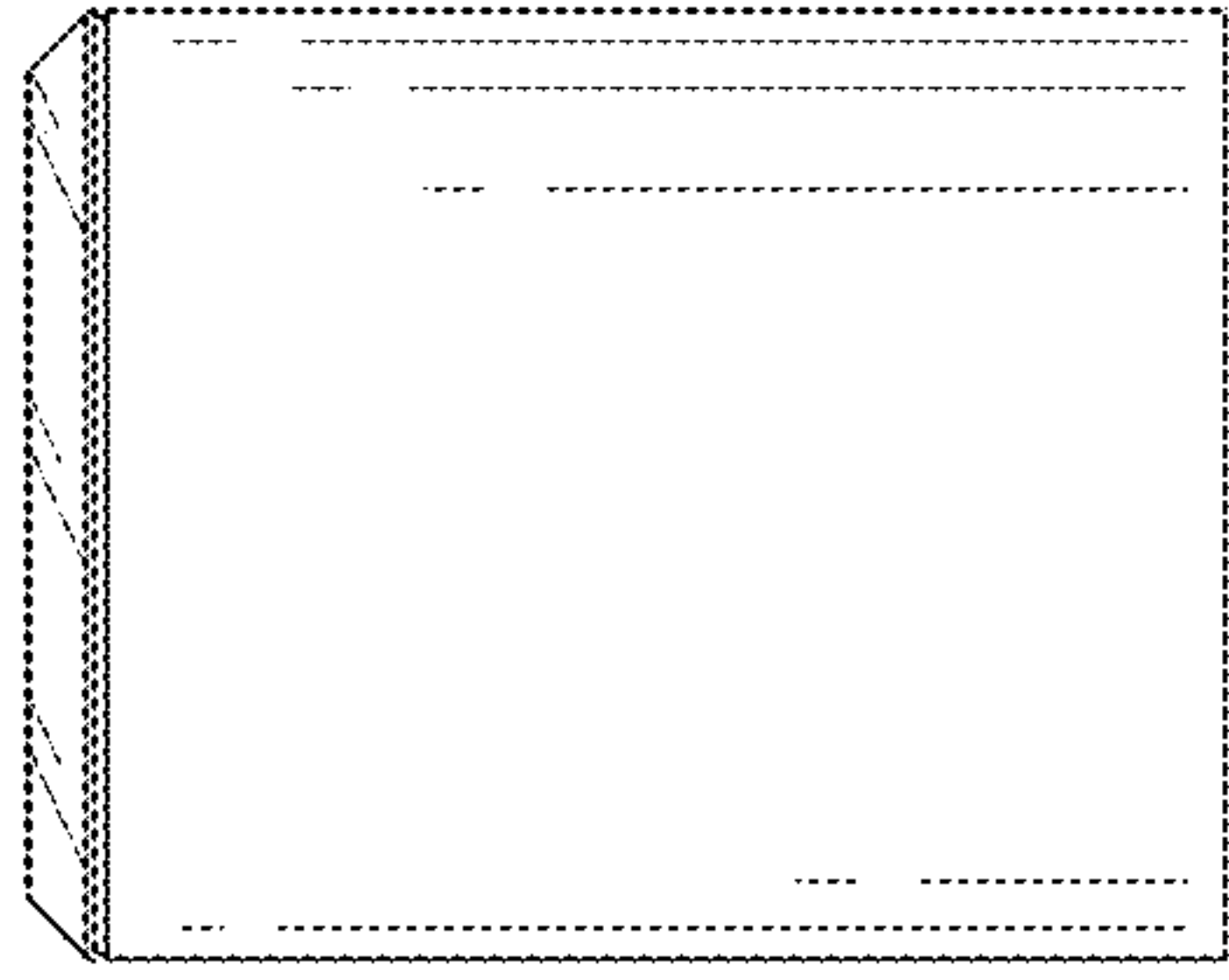

FIG. 19

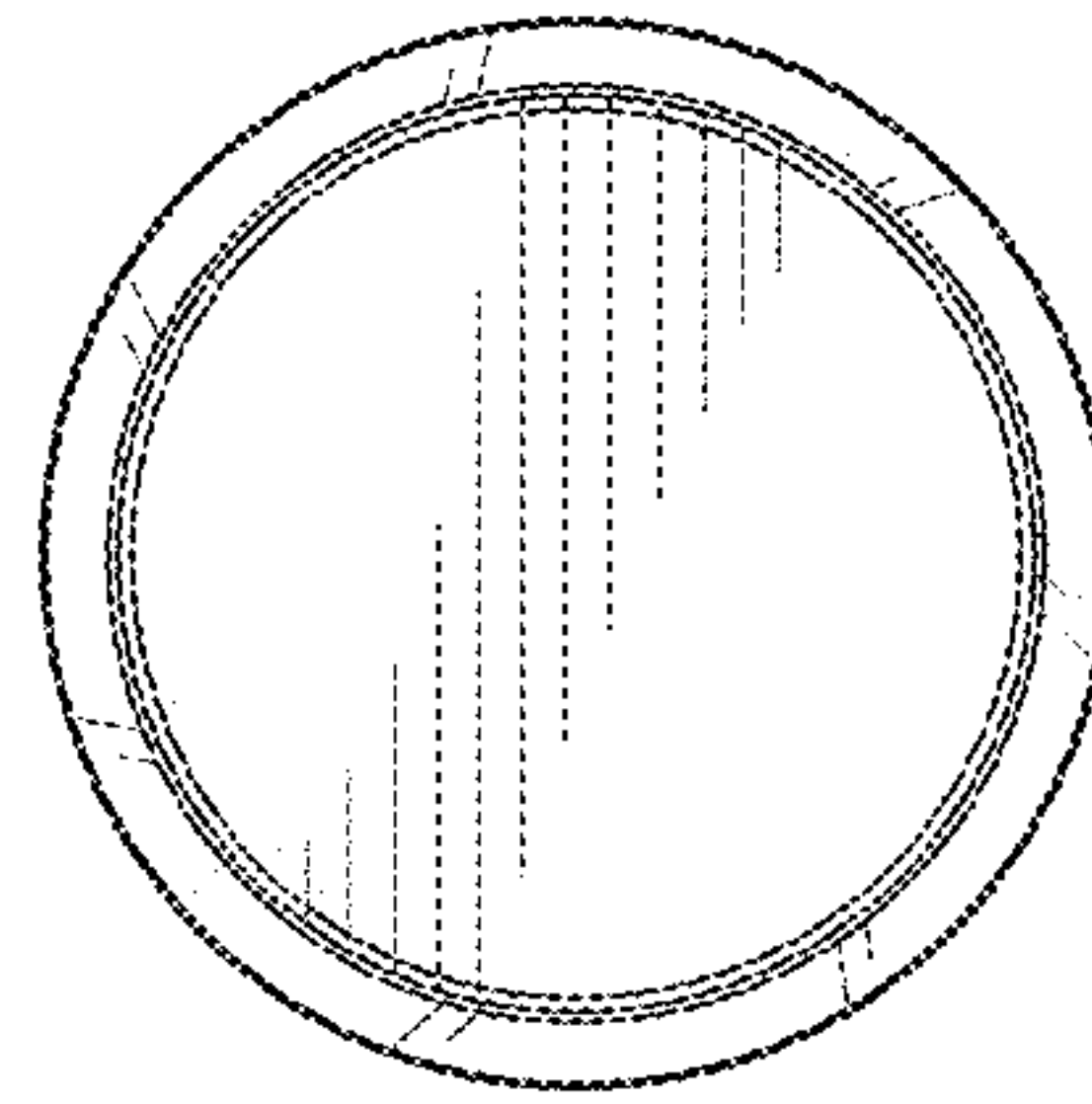

FIG. 20

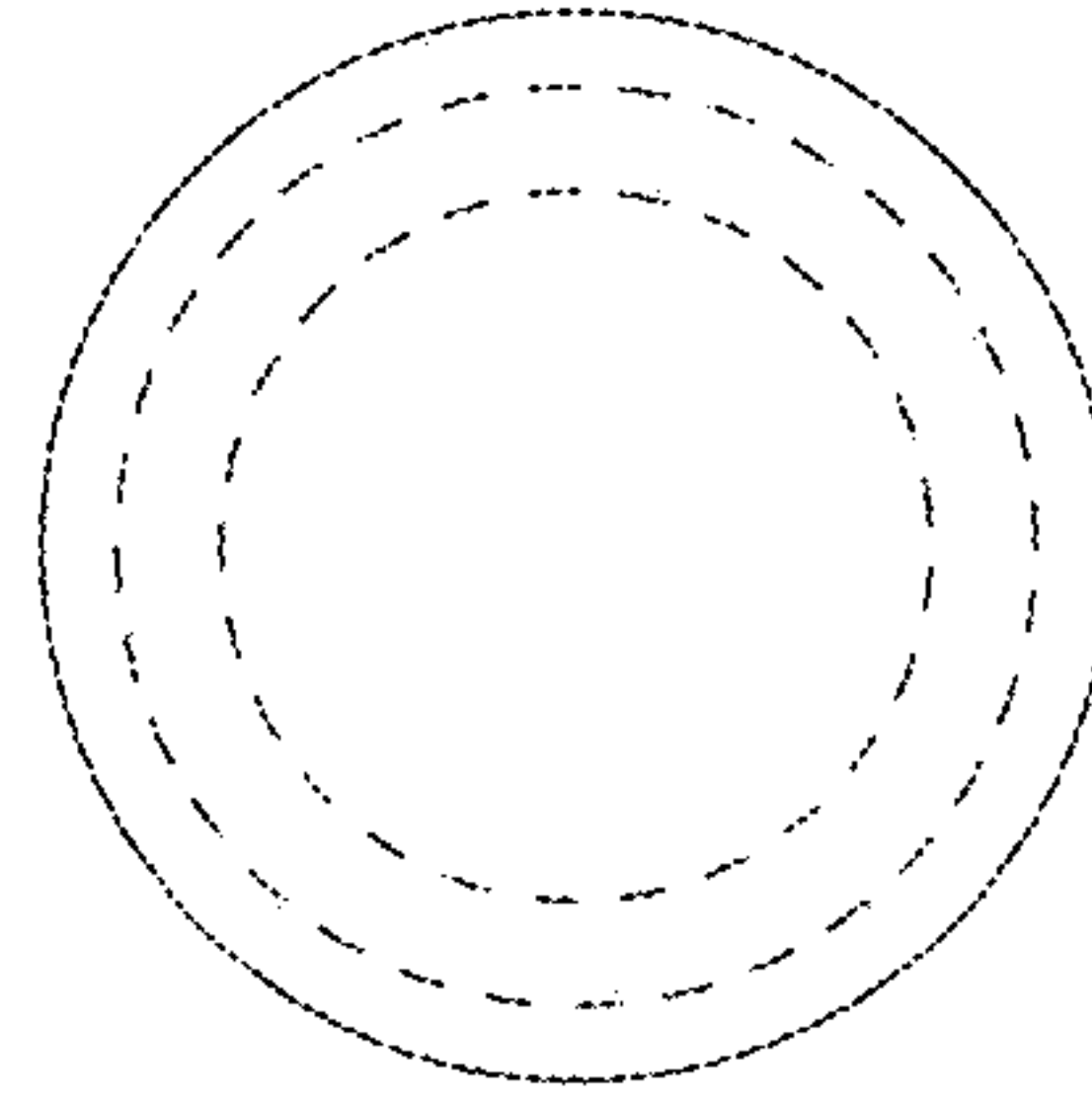

FIG. 21

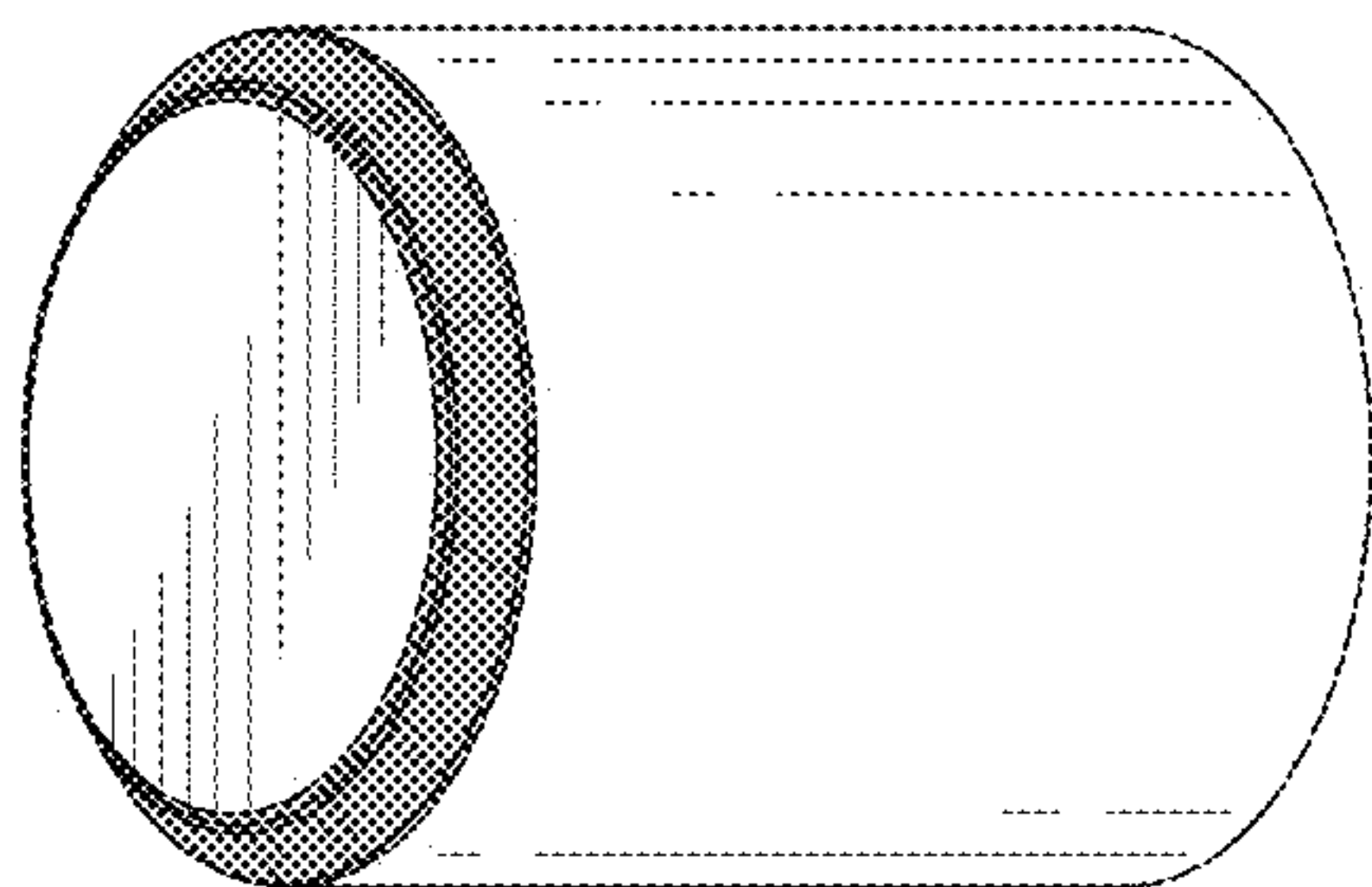

FIG. 22

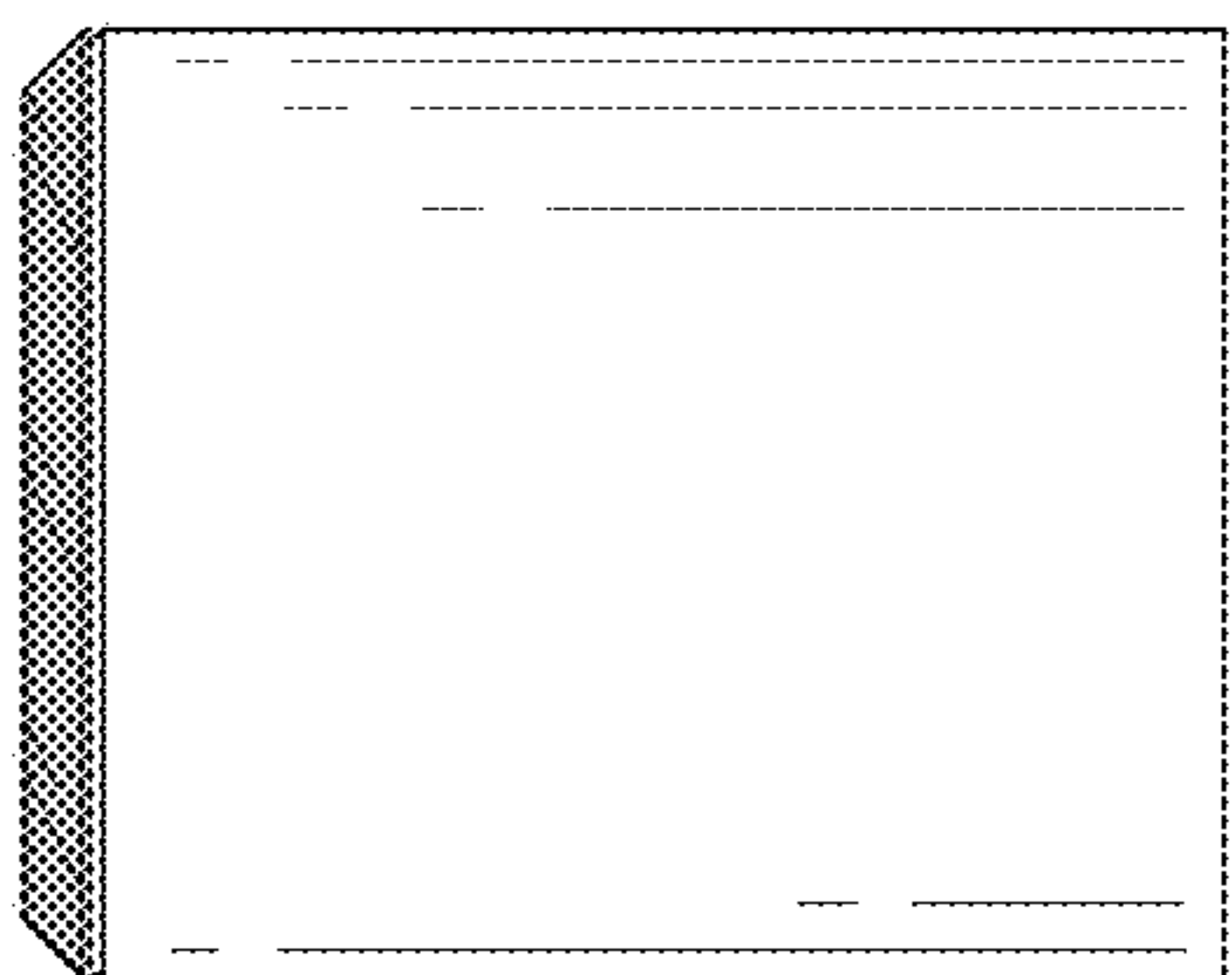

FIG. 23

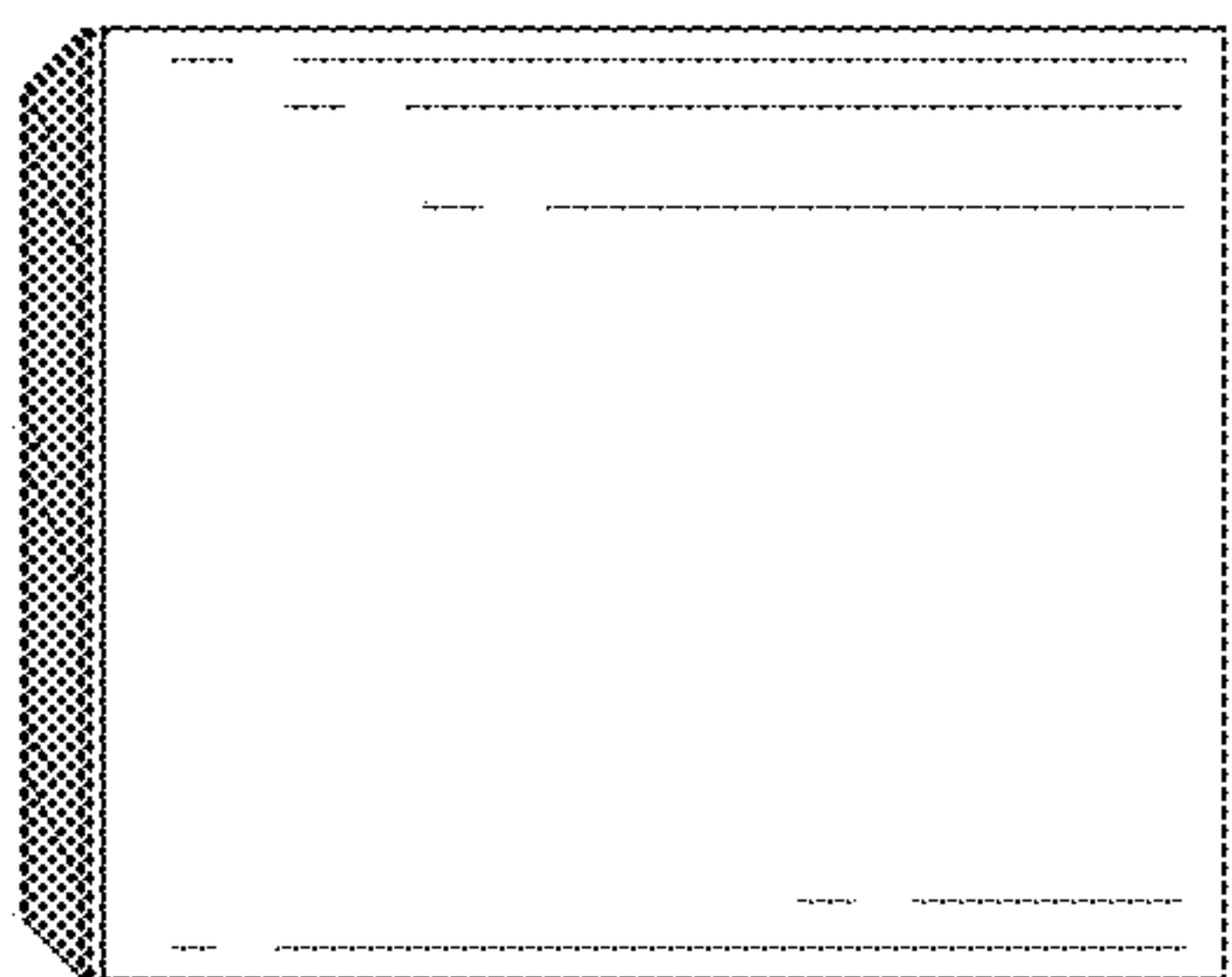

FIG. 24



FIG. 25

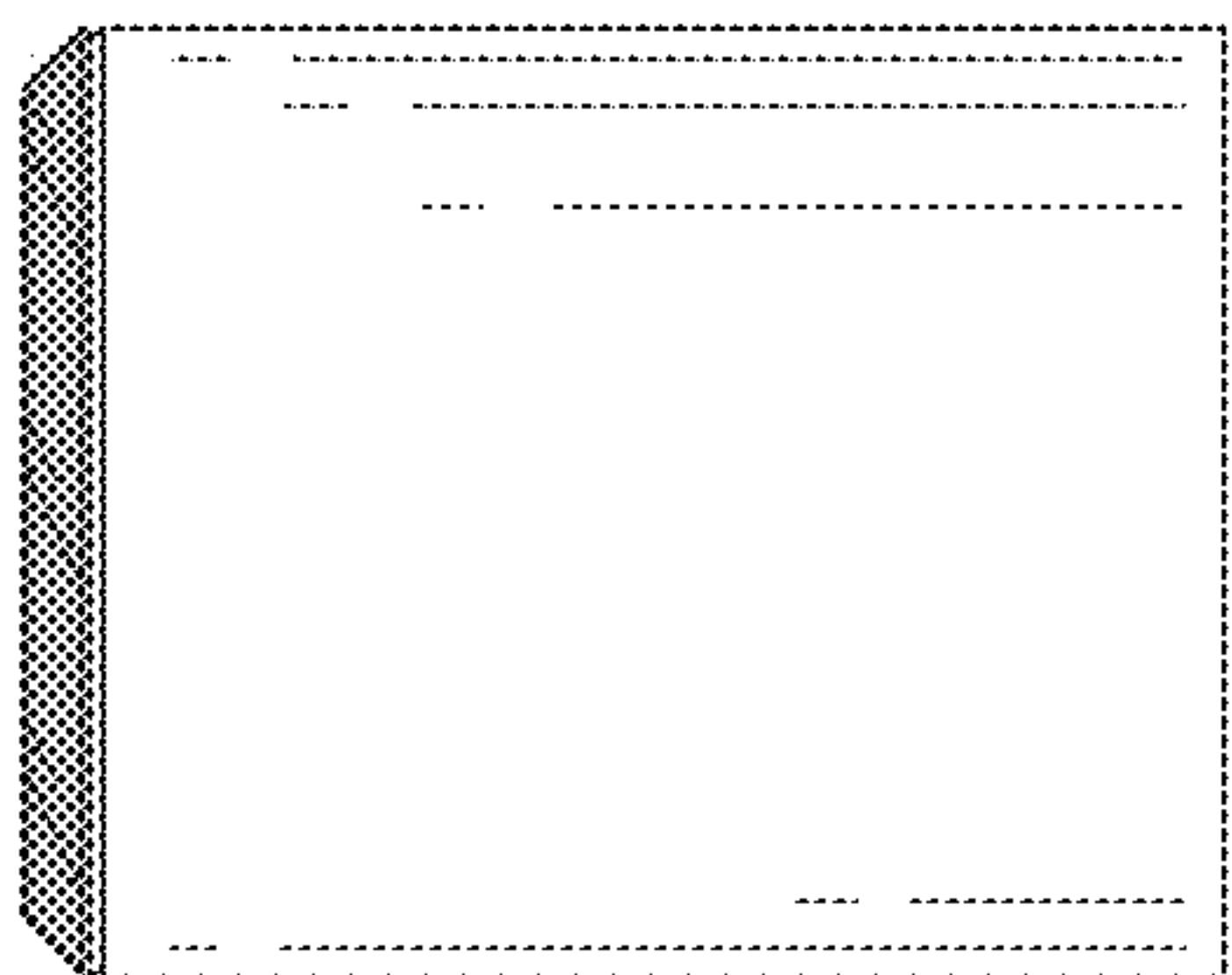

FIG. 26

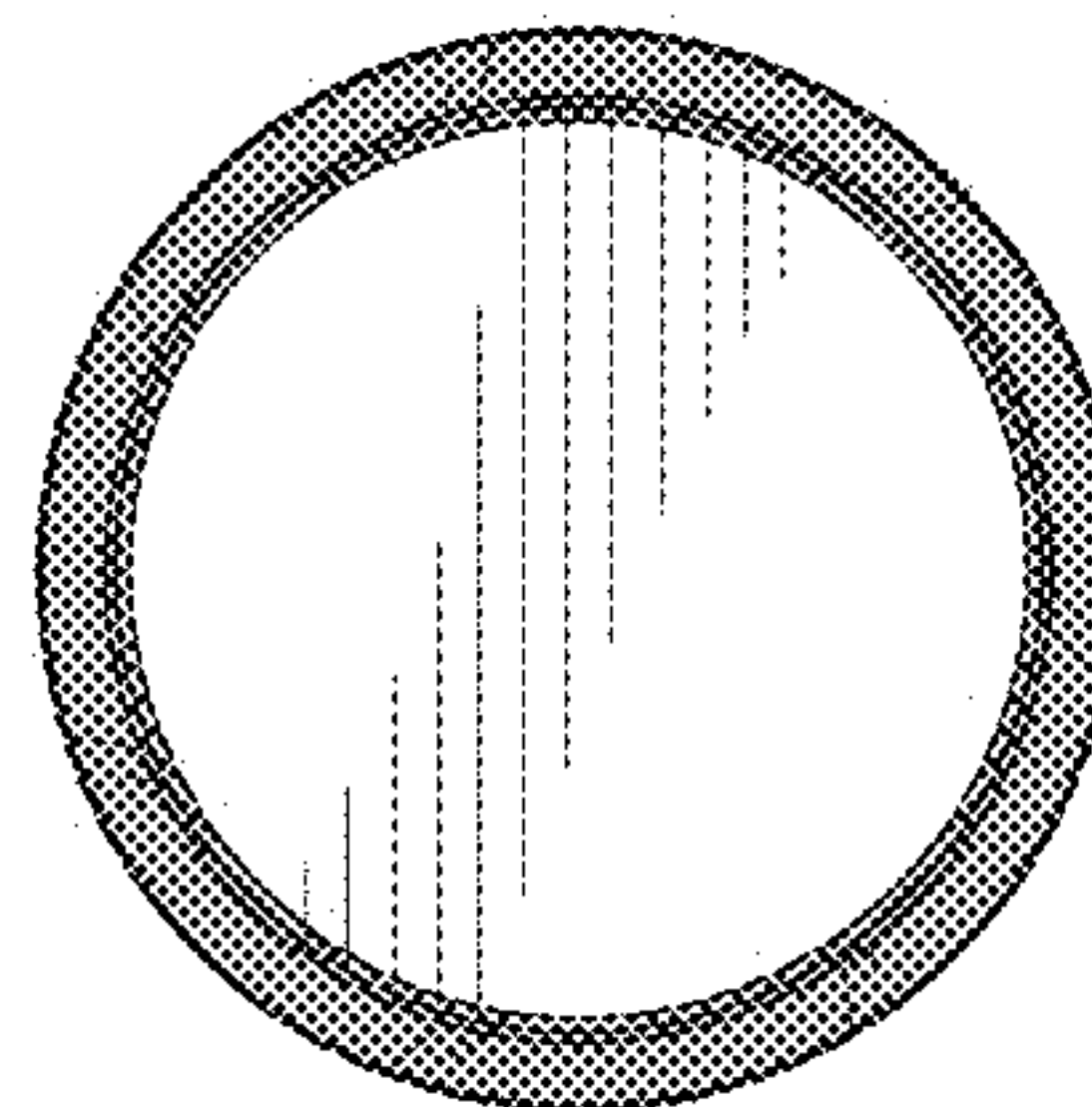

FIG. 27

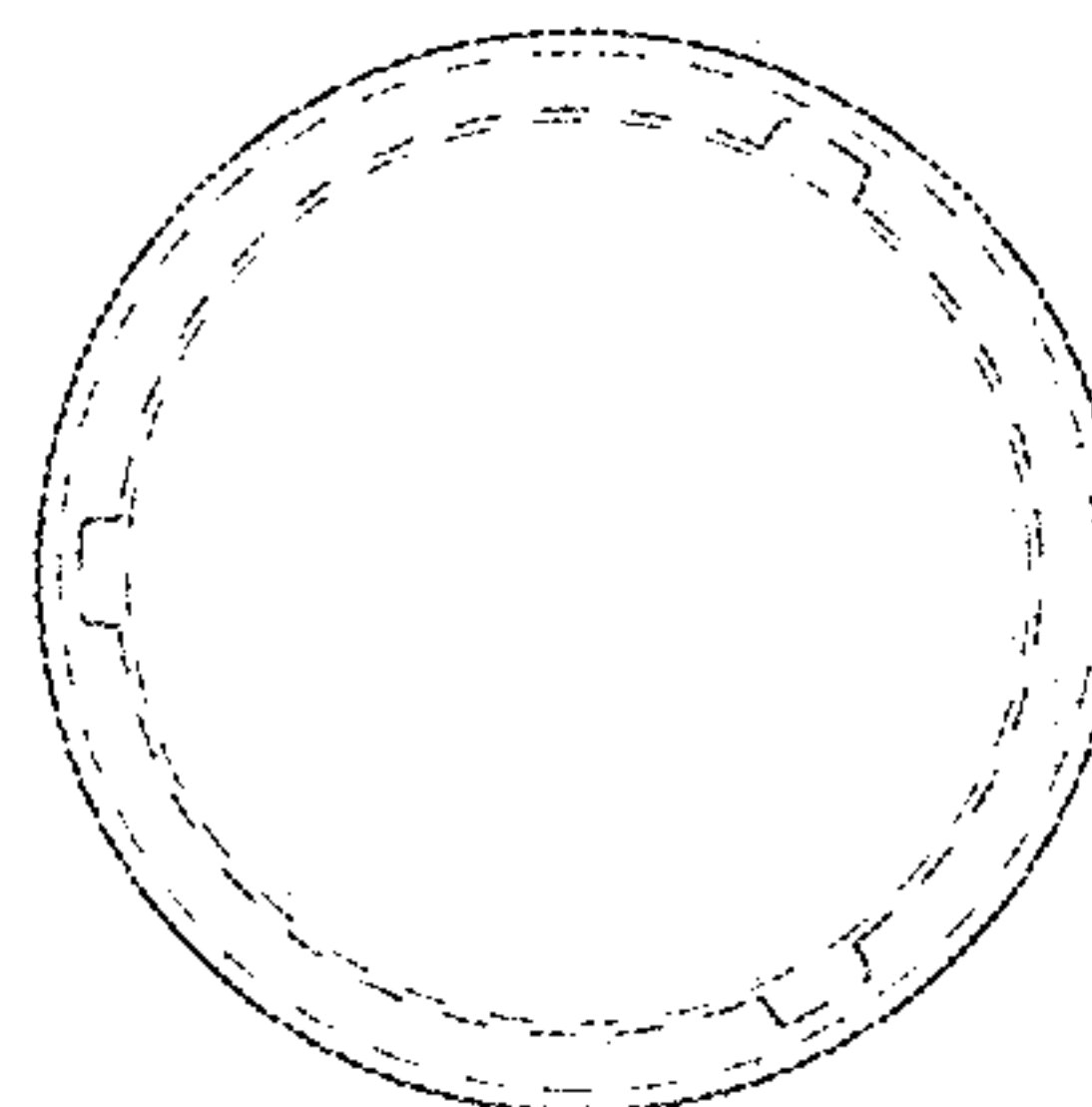

FIG. 28

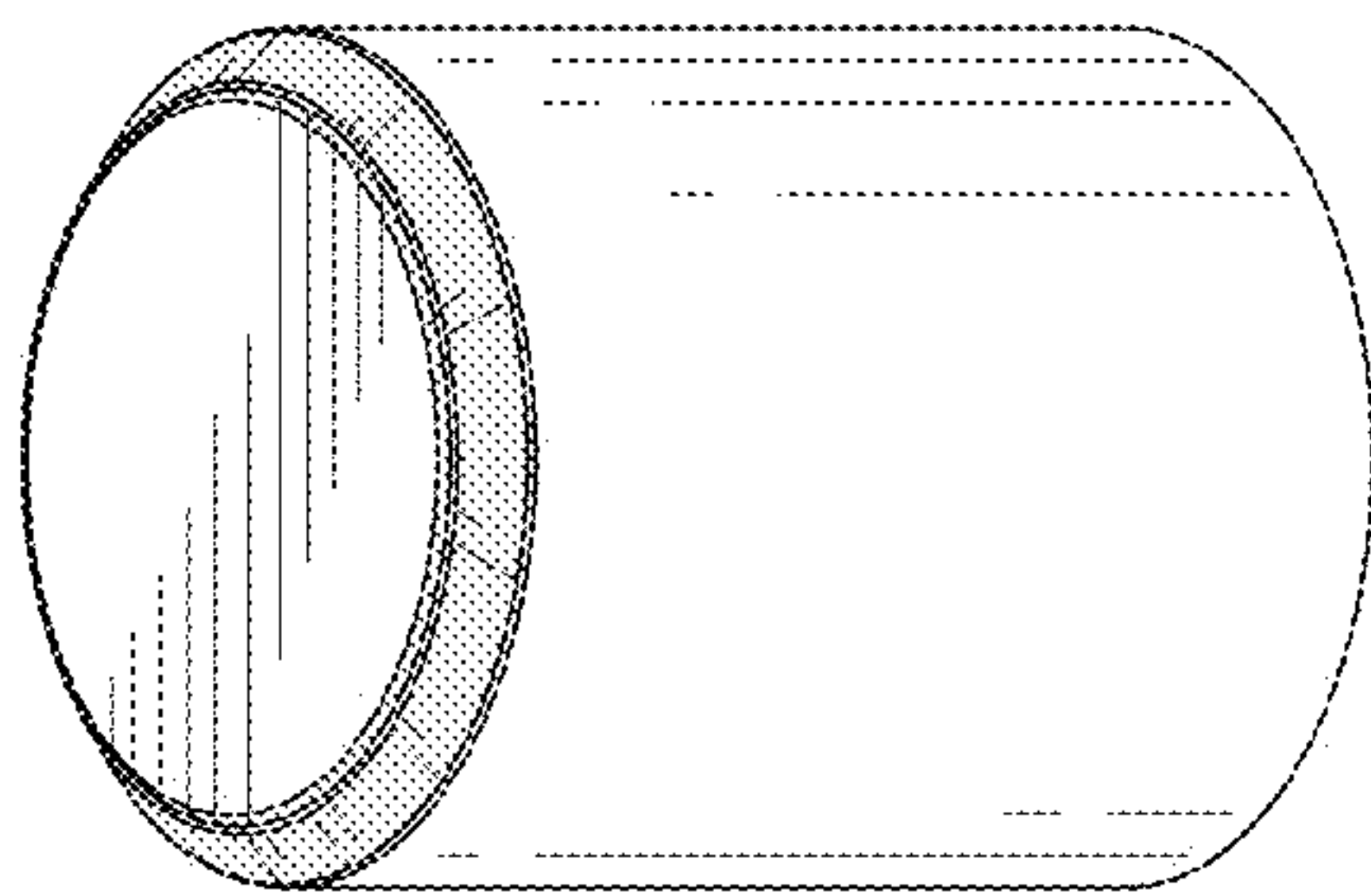

FIG. 29

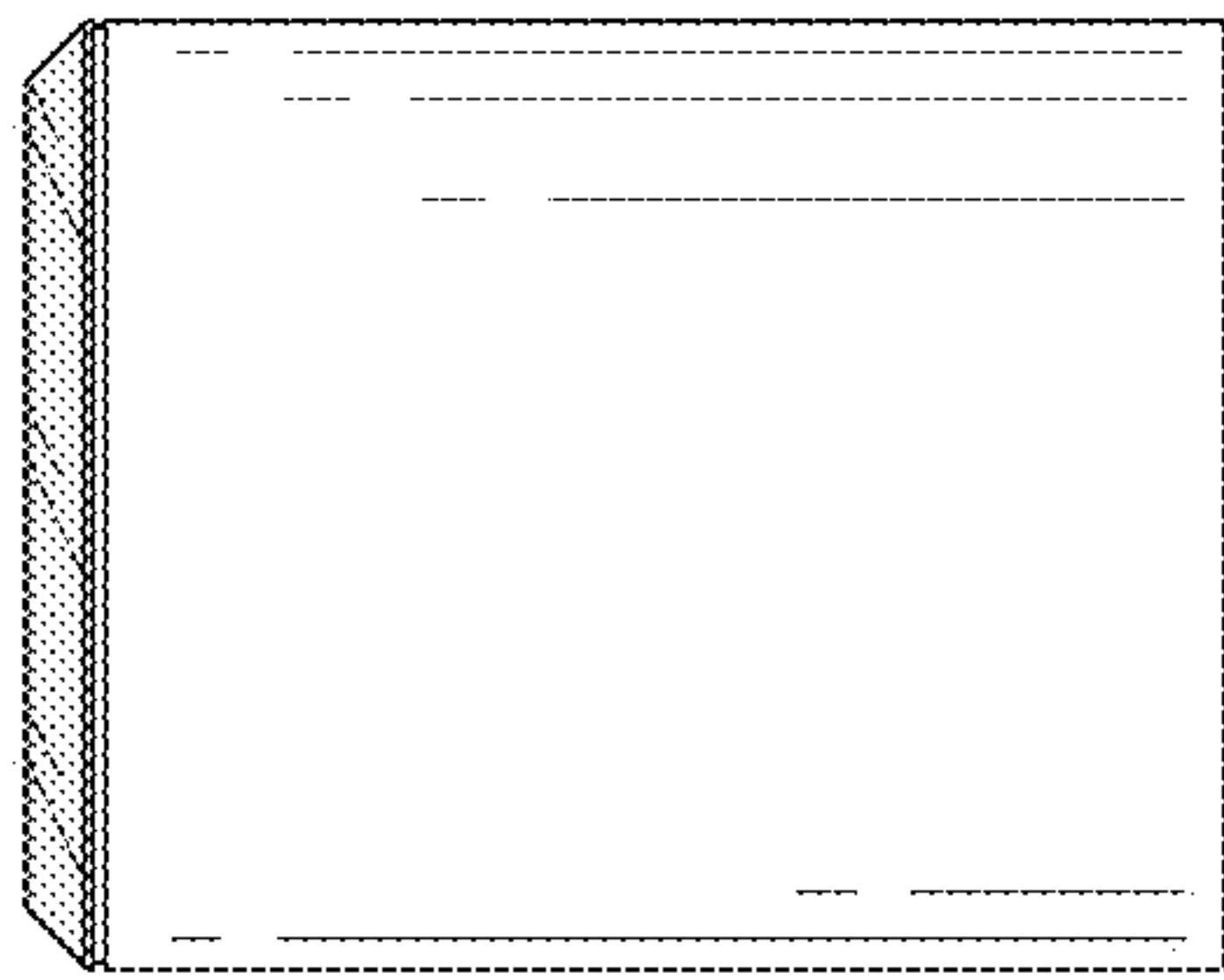

FIG. 30

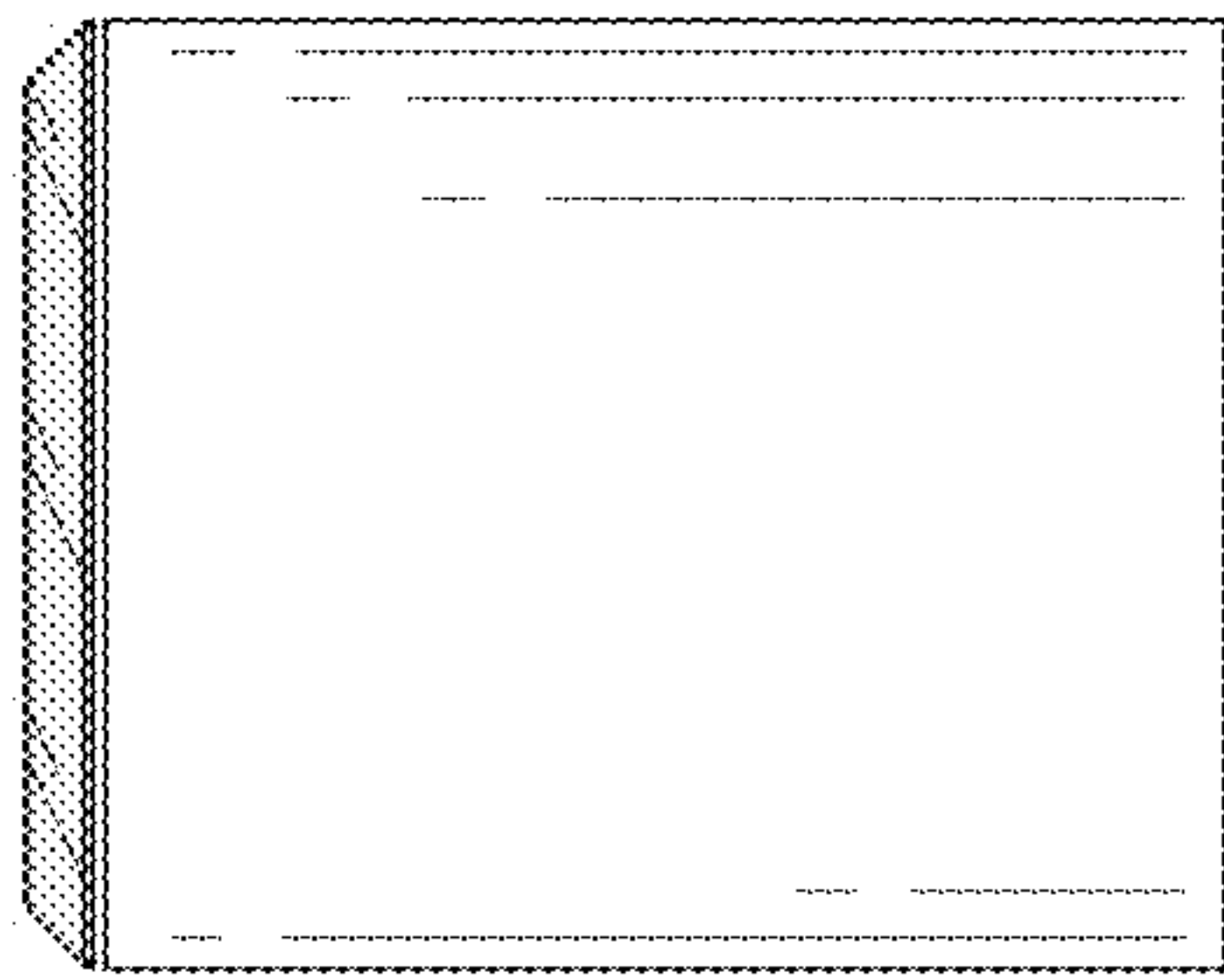

FIG. 31

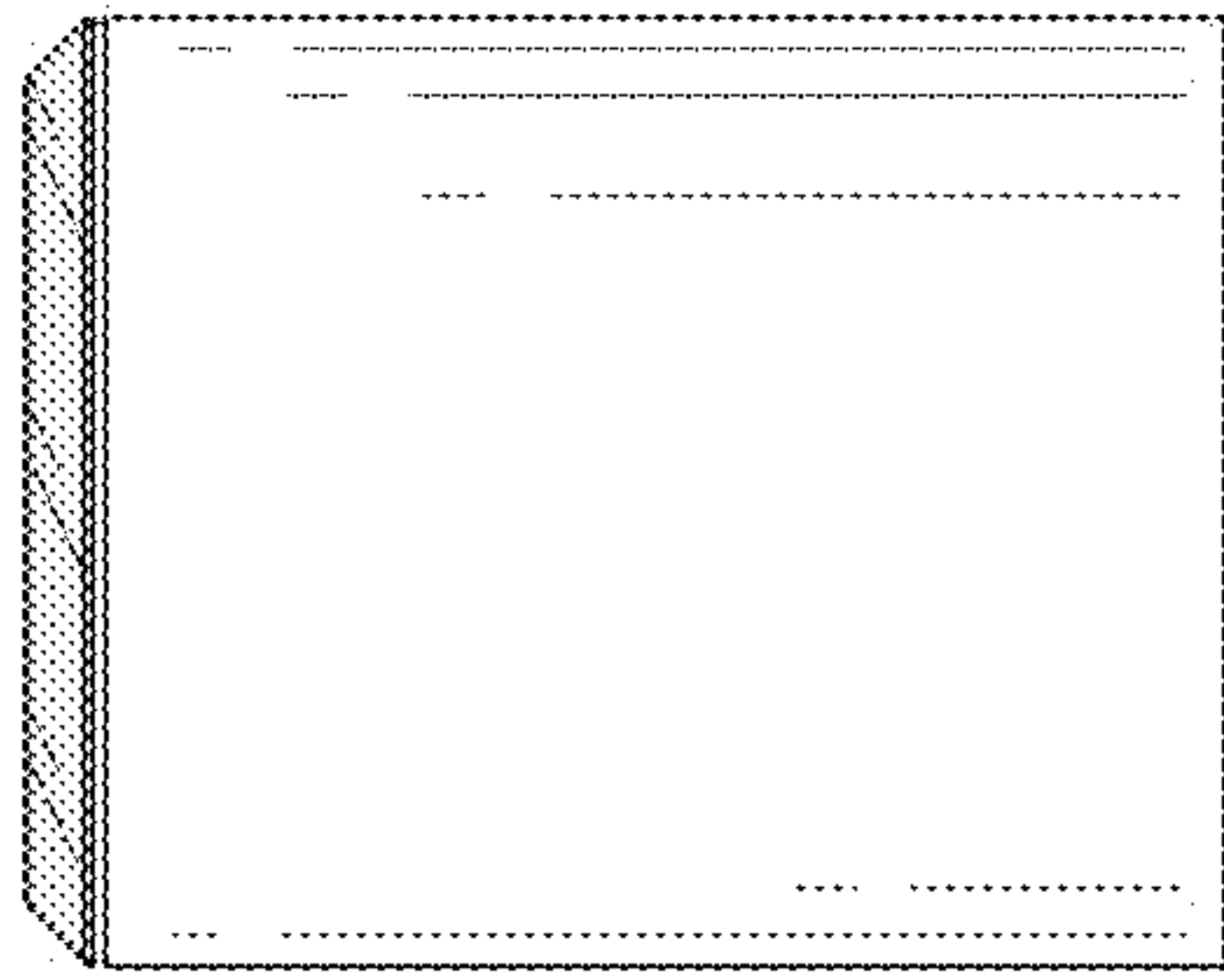

FIG. 32

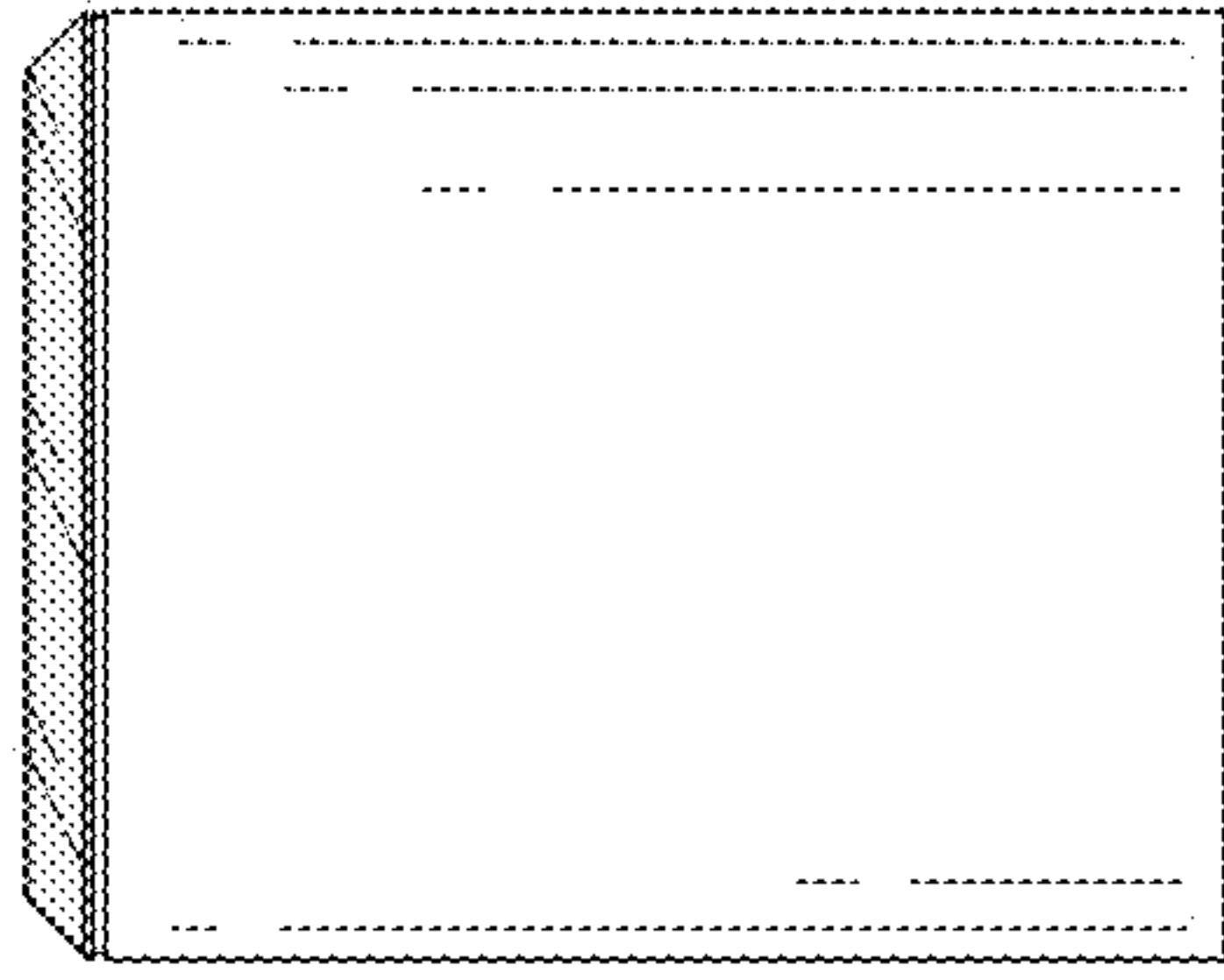

FIG. 33

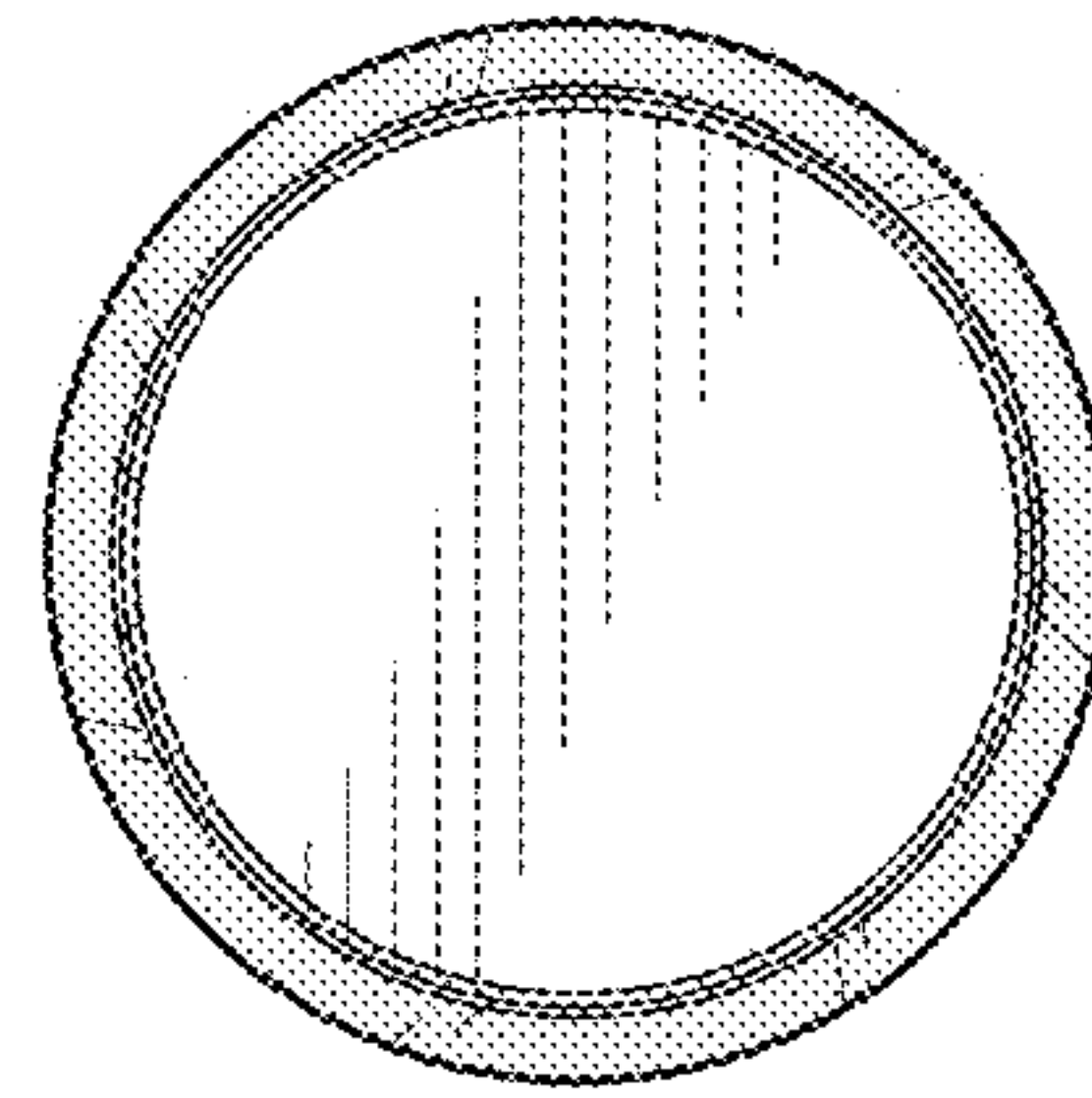

FIG. 34

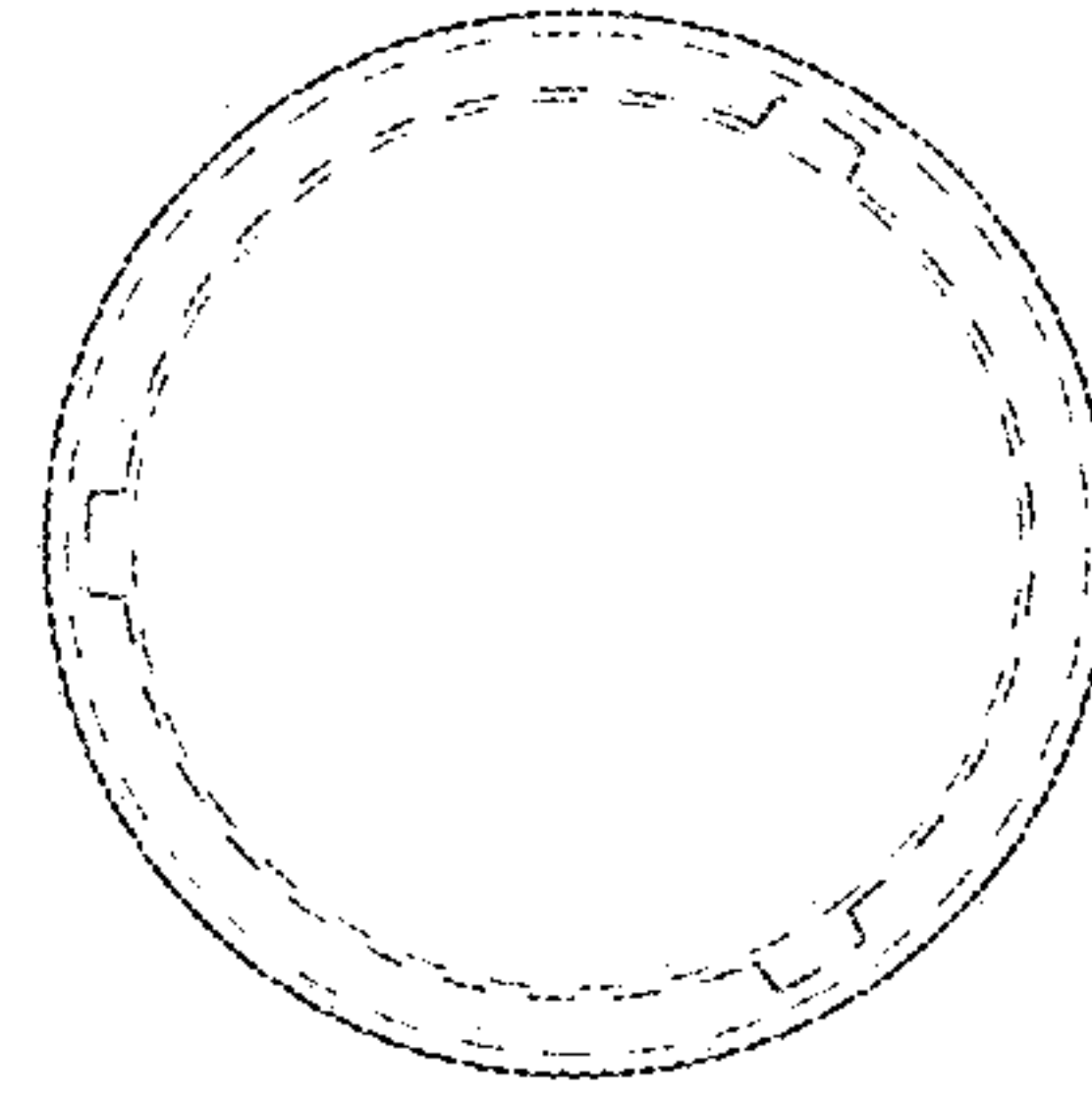

FIG. 35

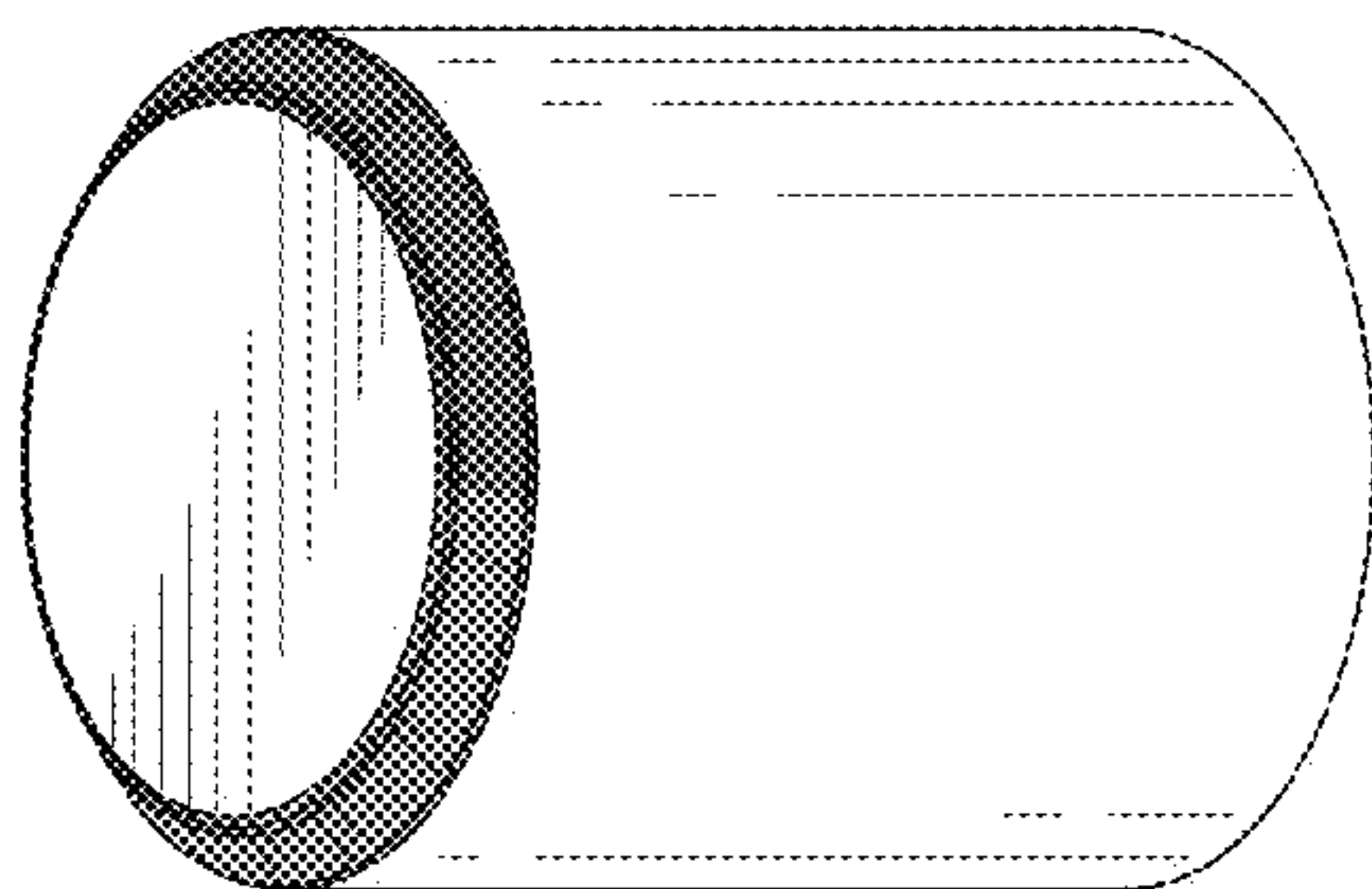

FIG. 36

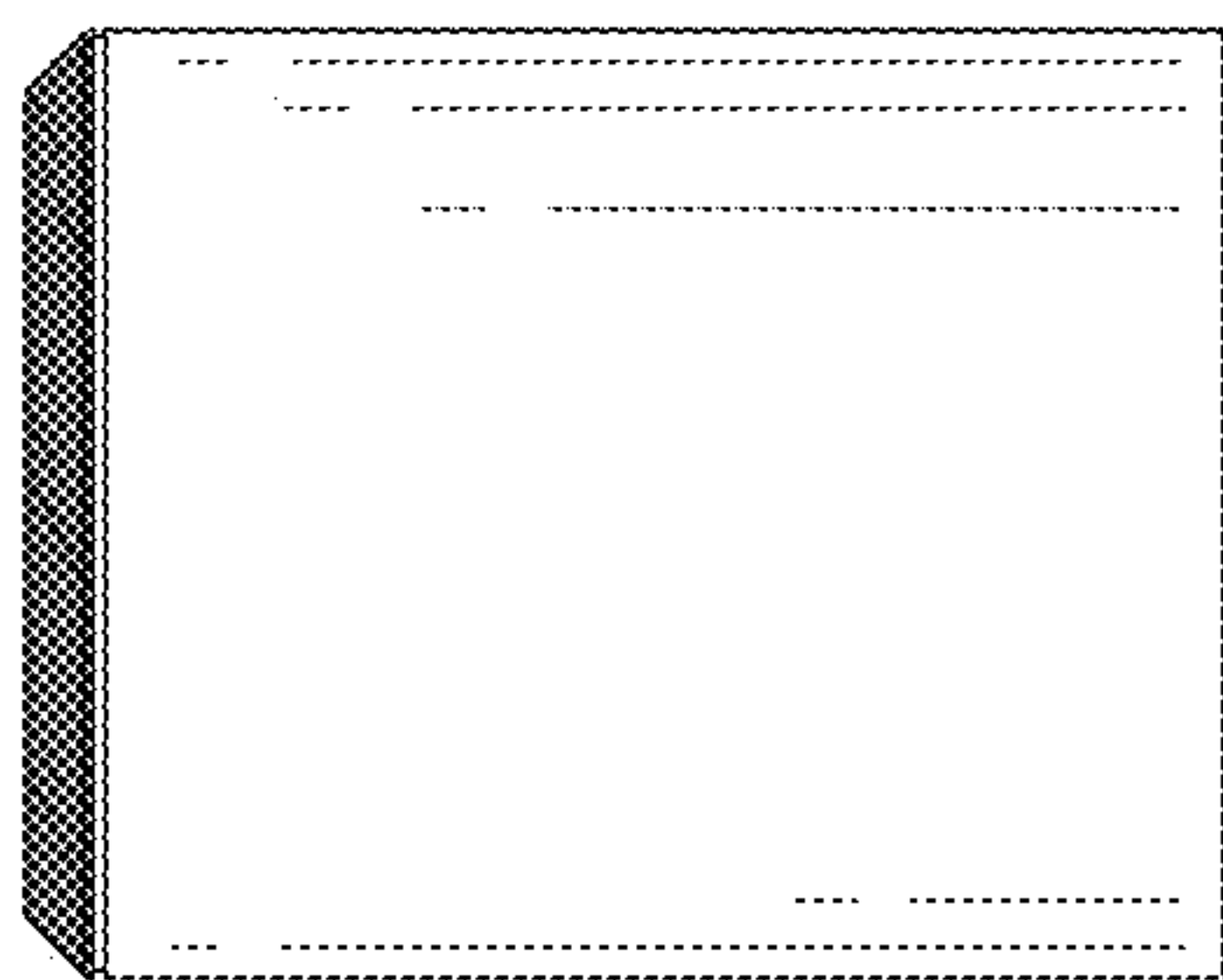

FIG. 37

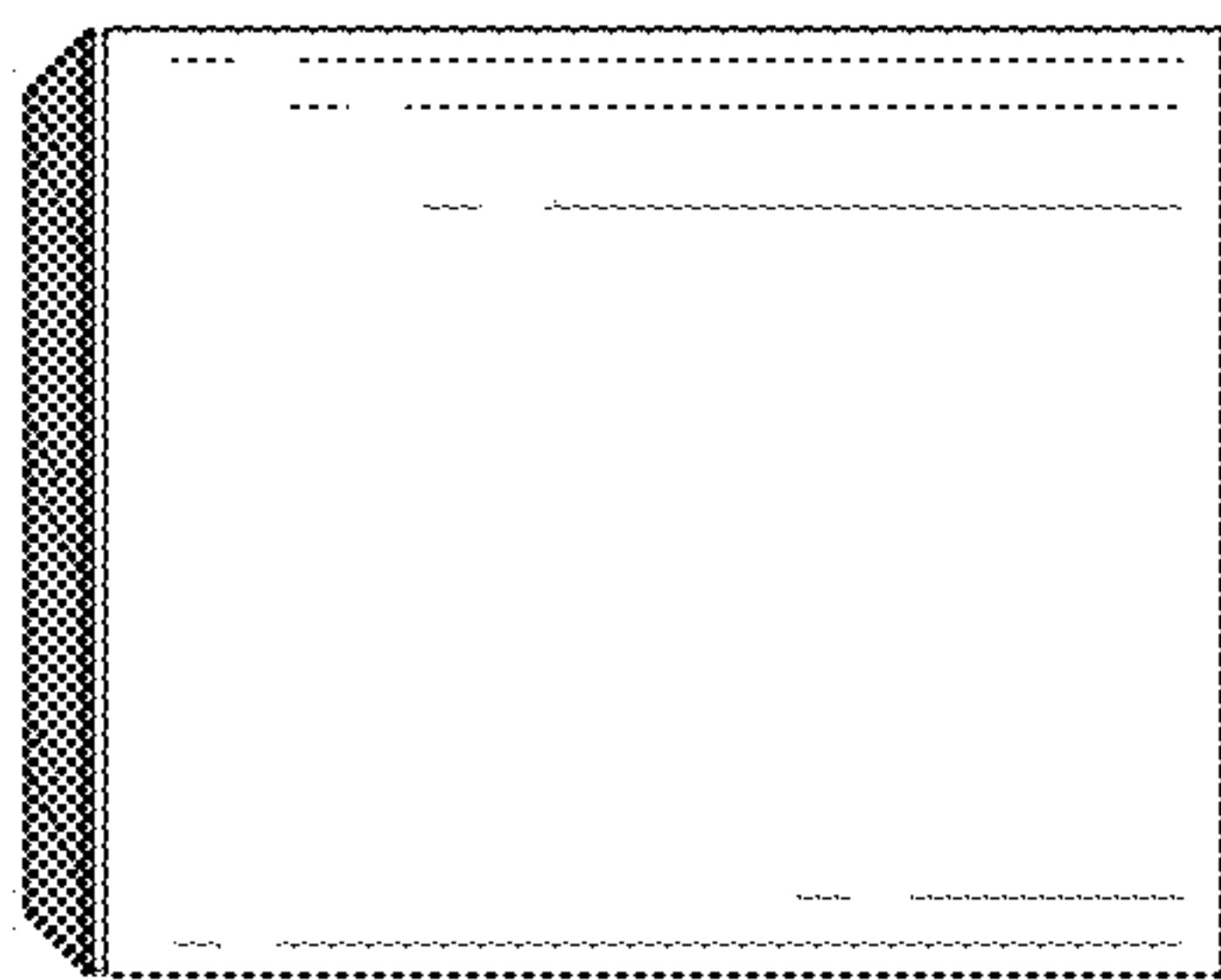

FIG. 38

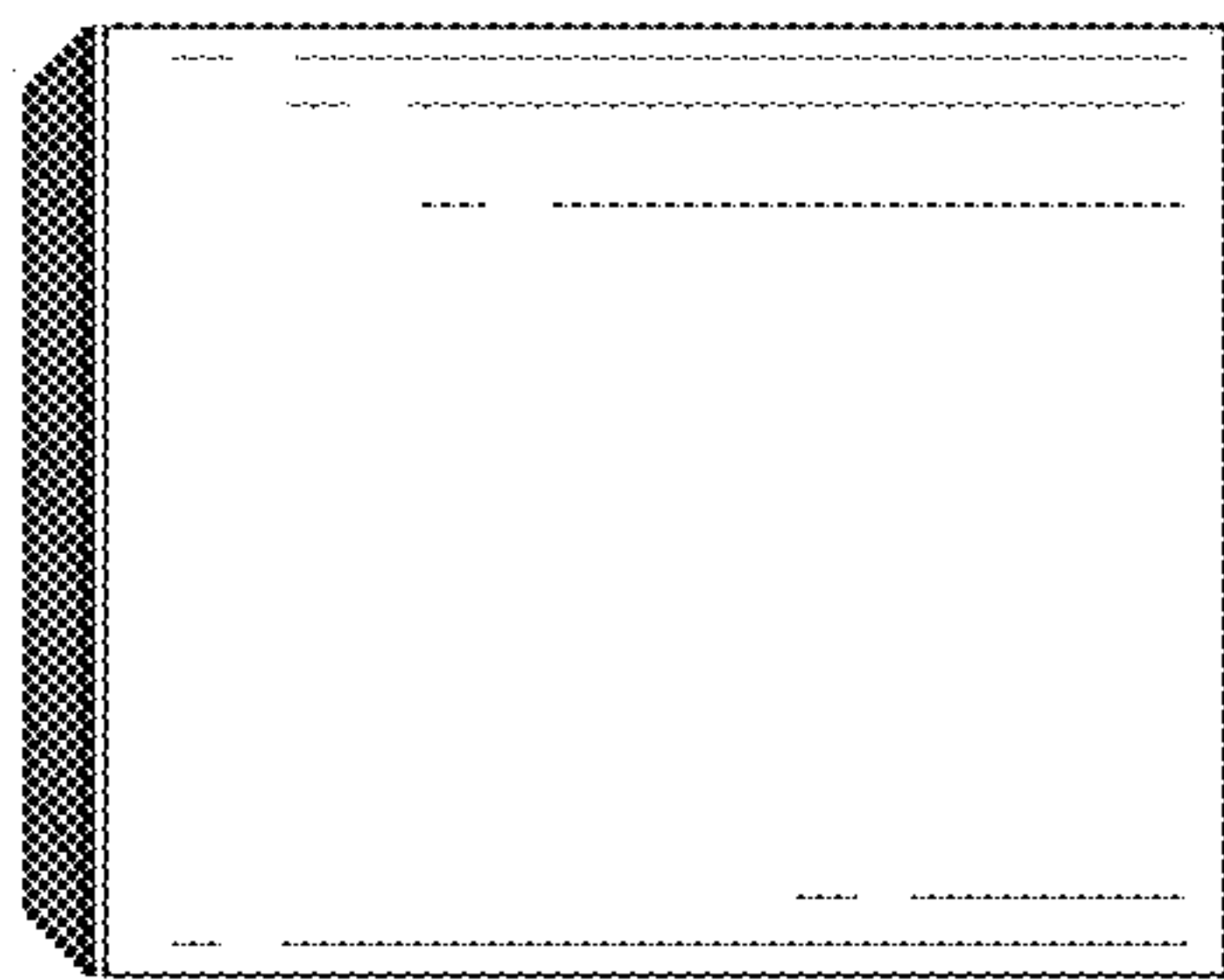

FIG. 39

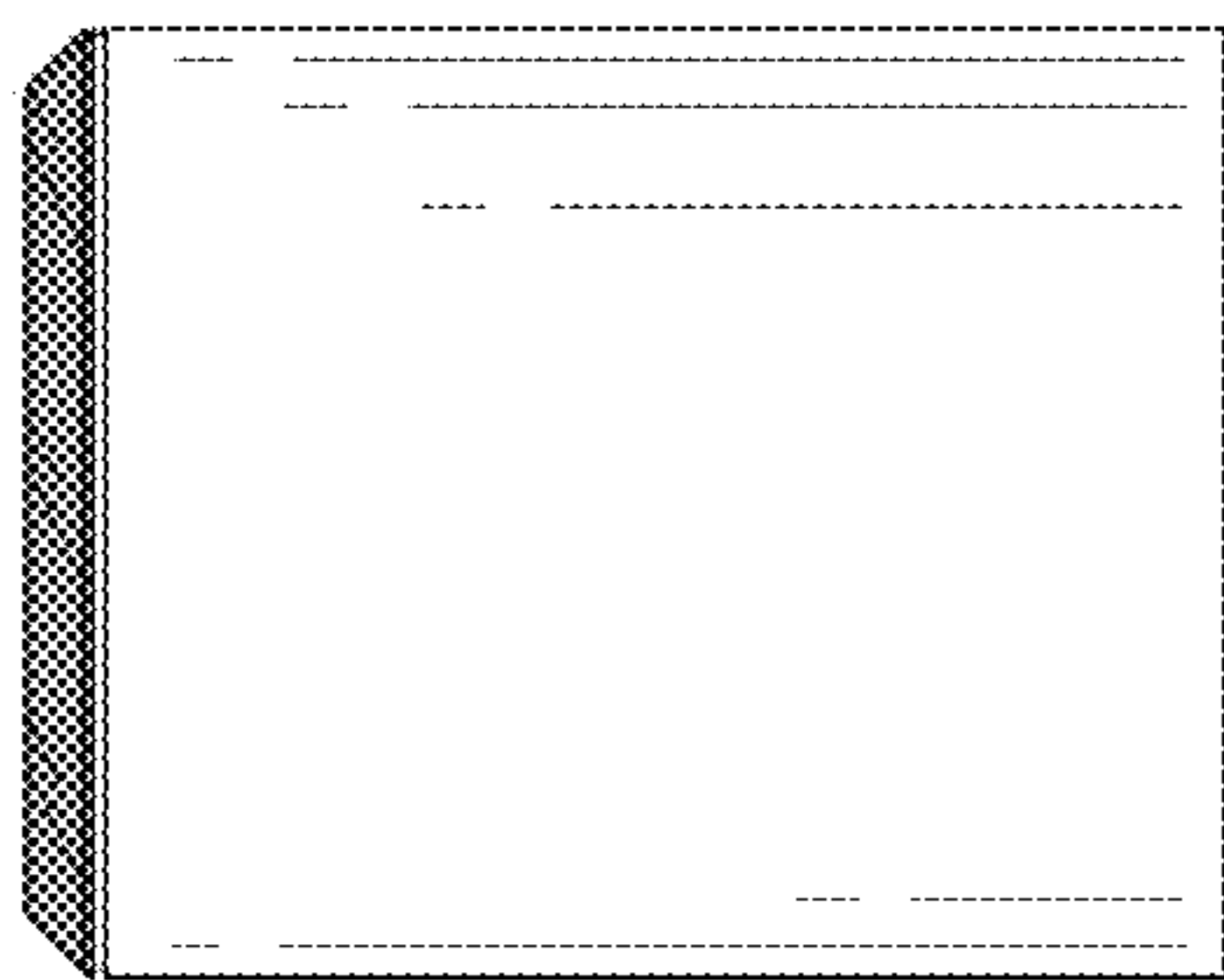

FIG. 40

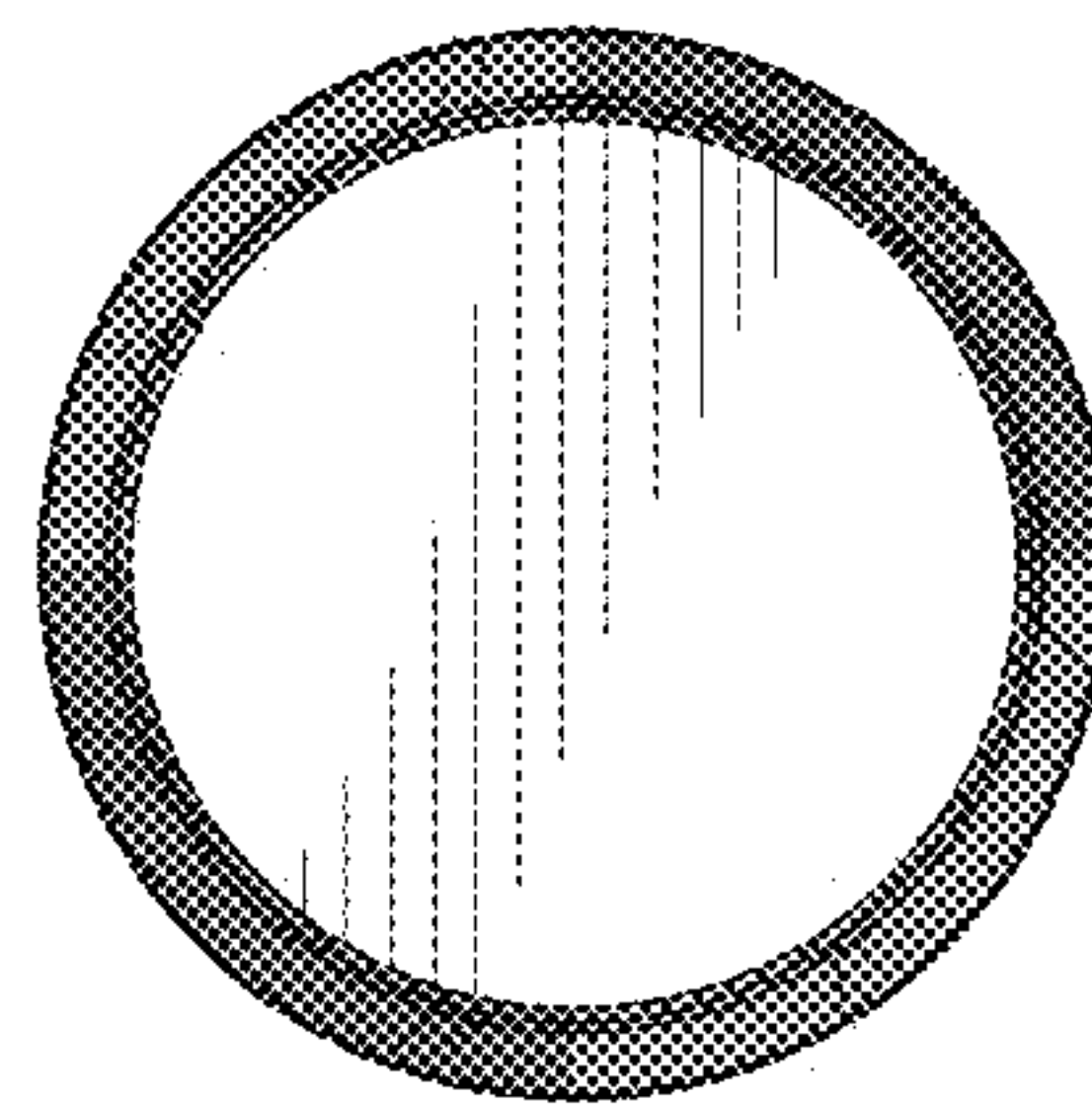

FIG. 41

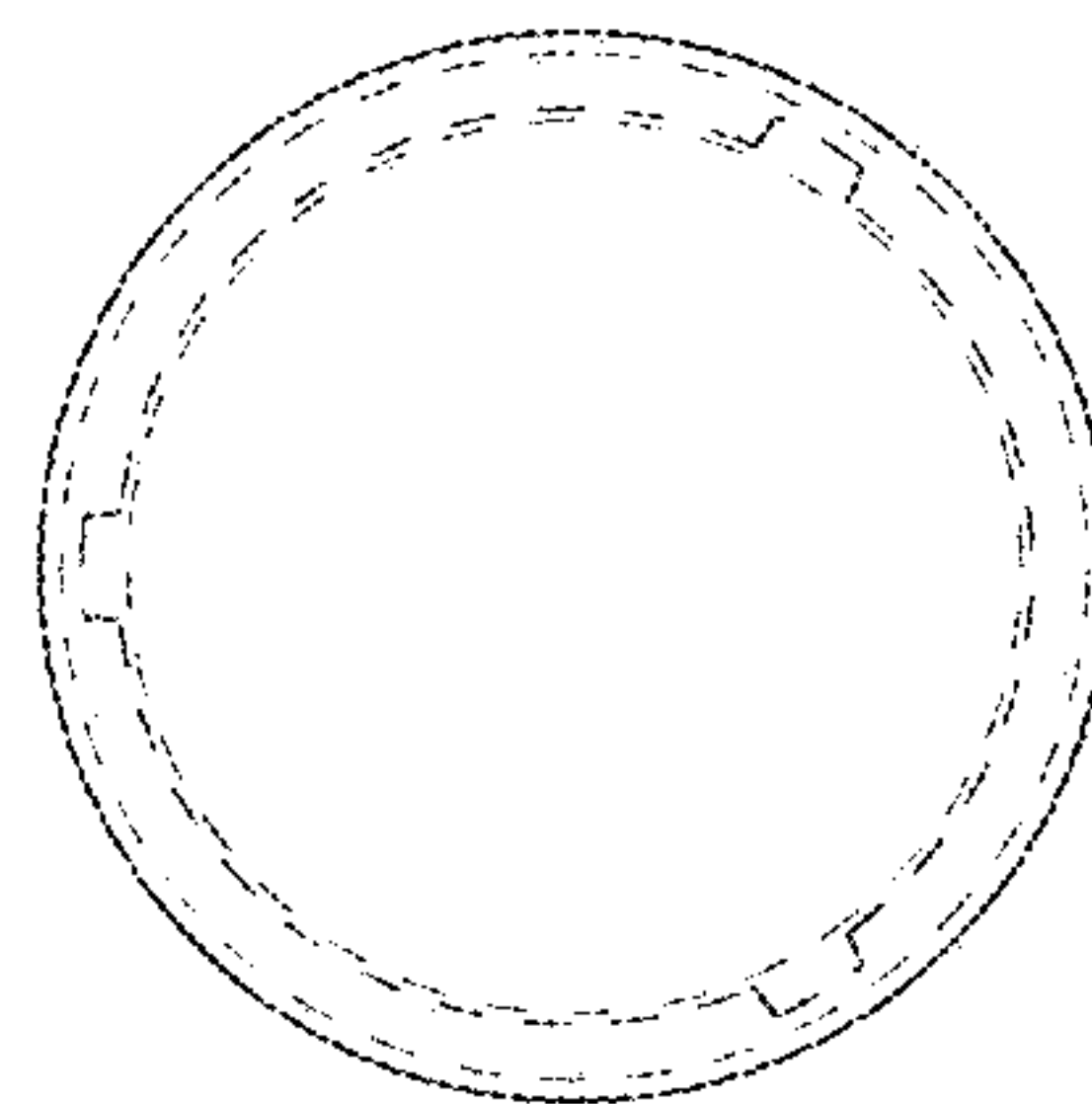

FIG. 42

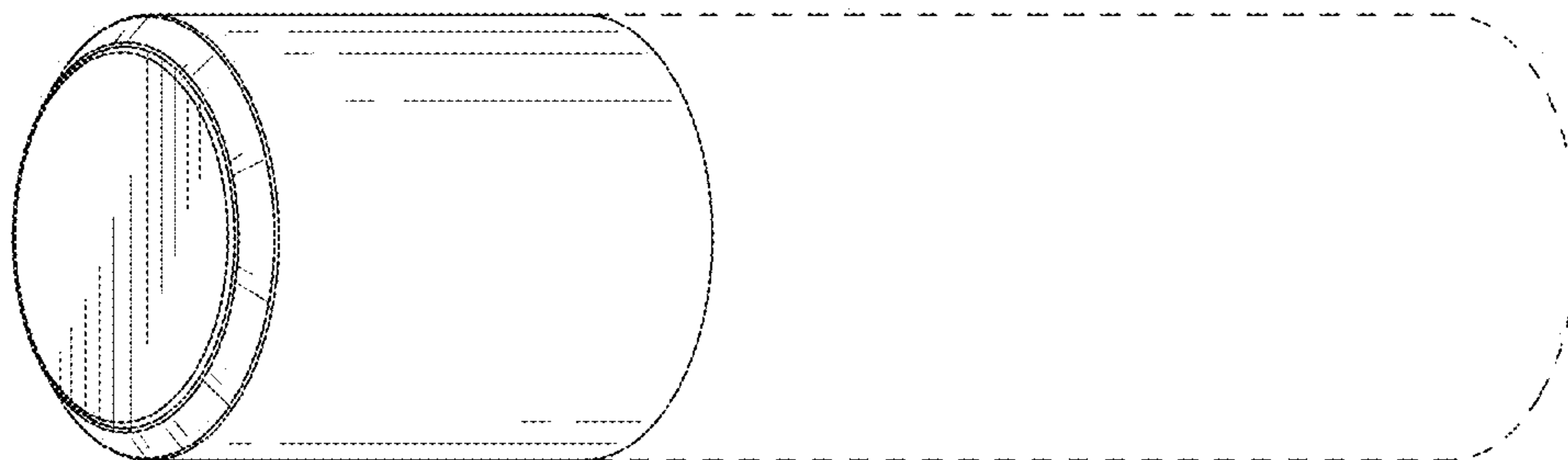

FIG. 43



FIG. 44

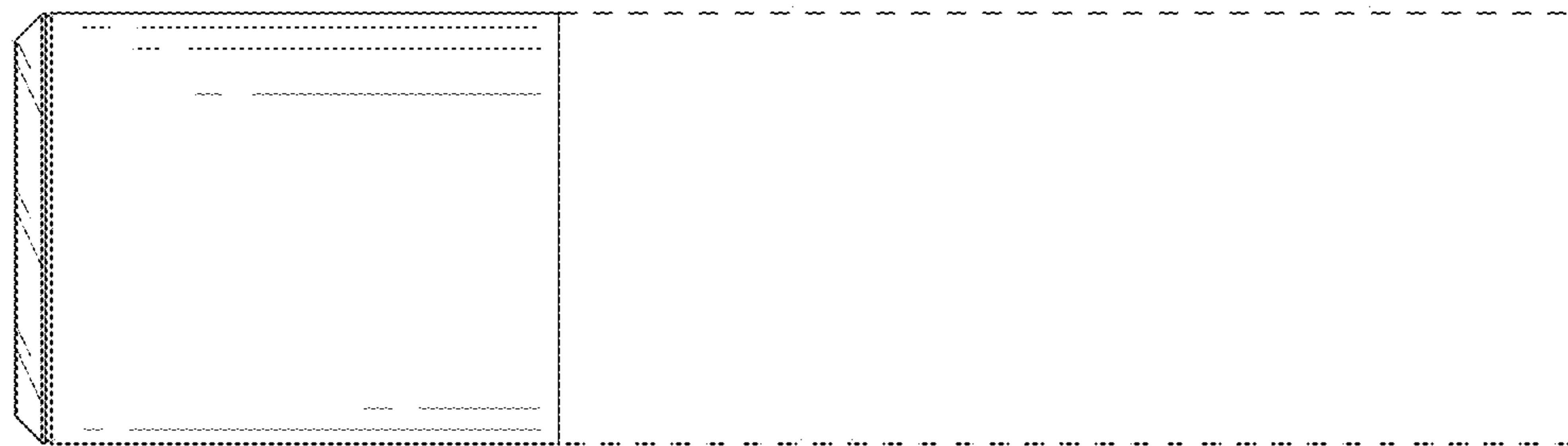

FIG. 45

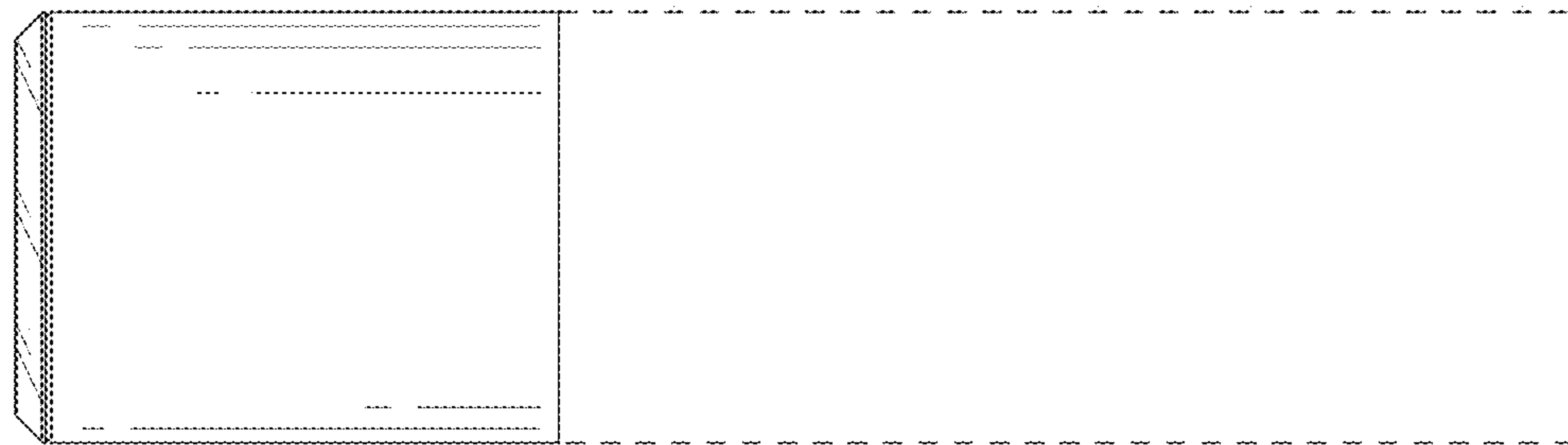

FIG. 46

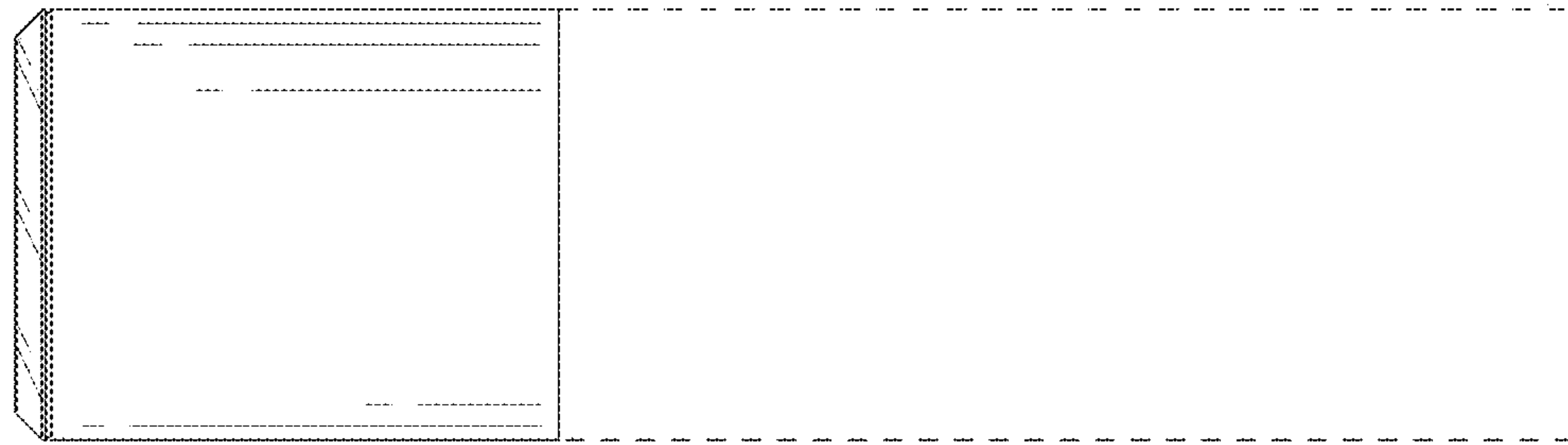

FIG. 47

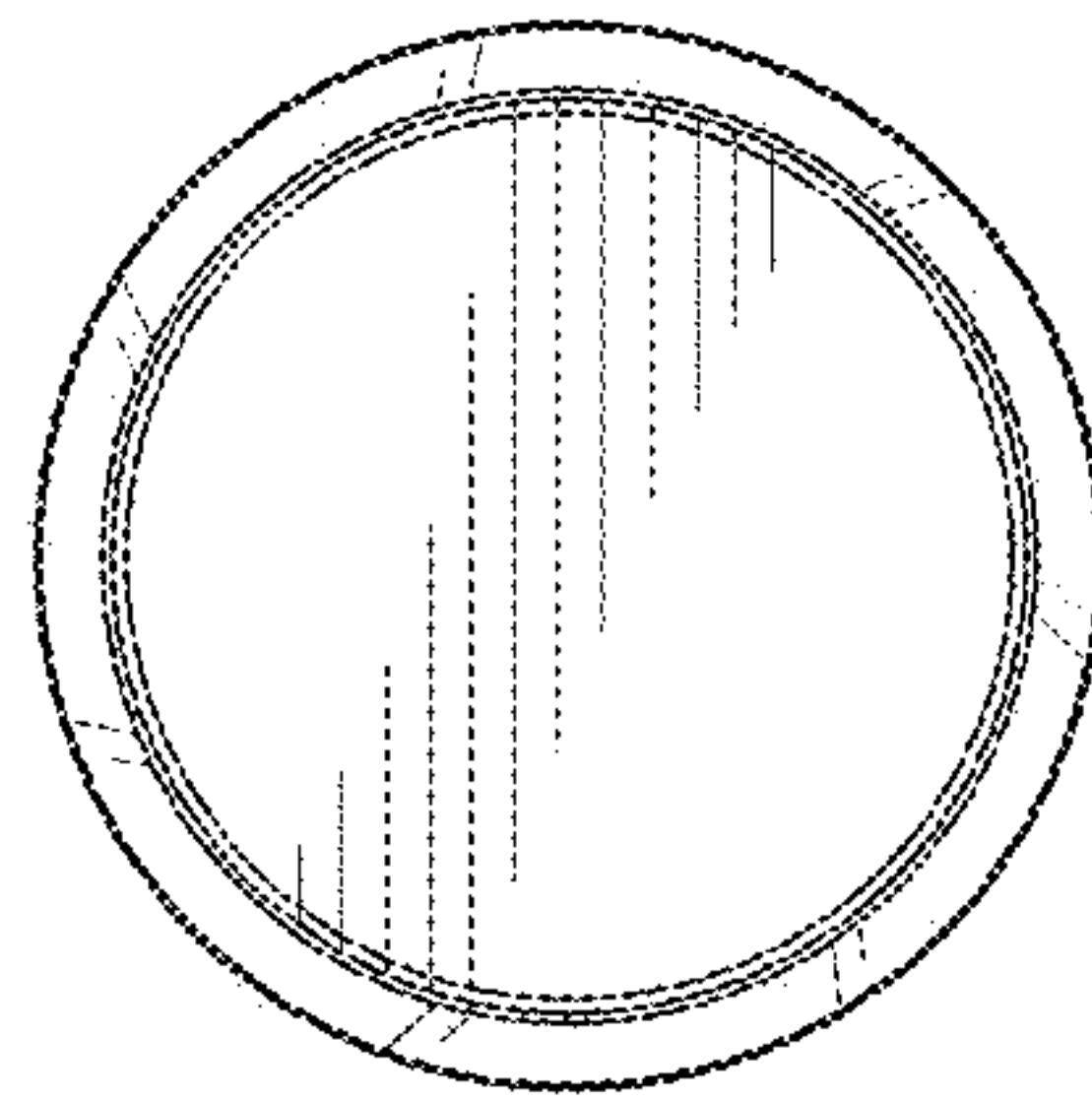

FIG. 48

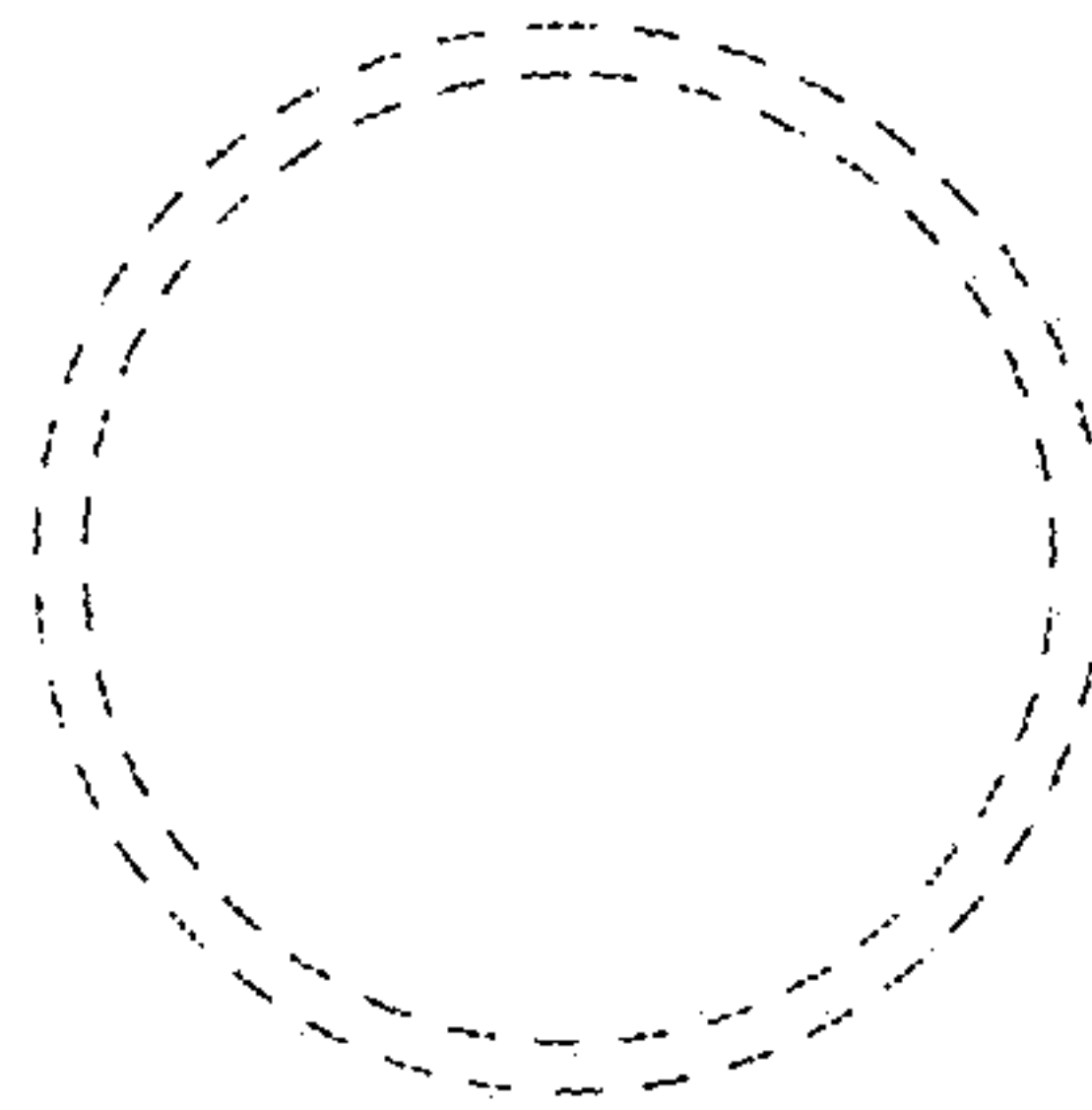

FIG. 49