



US00D894737S

(12) **United States Design Patent**
Merino

(10) **Patent No.:** **US D894,737 S**

(45) **Date of Patent:** **** *Sep. 1, 2020**

(54) **BOTTLE CAP**

(71) Applicant: **Packaging Products del Peru S.A.**,
Lima (PE)

(72) Inventor: **Alfredo Abel Merino**, Lima (PE)

(73) Assignees: **Alfredo Abel Merino**, Lima (PE);
Roberto Carlos Martínez, Lima (PE)

(*) Notice: This patent is subject to a terminal disclaimer.

(**) Term: **15 Years**

(21) Appl. No.: **29/658,738**

(22) Filed: **Aug. 2, 2018**

(51) **LOC (12) Cl.** **09-07**

(52) **U.S. Cl.**
USPC **D9/452**

(58) **Field of Classification Search**

USPC D3/202, 203.1, 203.2, 318; D7/300,
D7/300.1, 316, 317, 323, 354, 387, 391,
D7/392, 392.1, 393, 396.1, 396.2, 396.4,
D7/397, 398, 503, 509, 510, 511, 523,
D7/526-531, 538, 566, 568, 600.1, 602,
D7/603, 614, 619.1, 629, 704, 900;
D9/434, 435, 440, 447, 452, 453, 454,
D9/499, 516, 529, 686, 723, 433, 445,
D9/456; D24/121, 127, 199, 224;
D23/249, 259, 260, 261; D8/14, 14.1,
D8/45, 300, 307, 343, 354, 400, 402;
D15/138, 143; D34/7, 10, 11; D28/76,
D28/84, 85, 91.1; D19/192, 194
CPC B65D 2517/5091; B65D 41/04; B65D
23/12; B65D 1/0246; B65D 47/265;
B65D 47/065; B65D 51/24; B65D
51/224; B65D 51/245; B65D 2101/0015;
B65D 2251/0093; B65D 85/72; B65D
51/18; B65D 51/28; B65D 51/242; B65D
51/2814;

(Continued)

(56) **References Cited**

U.S. PATENT DOCUMENTS

468,226 A * 2/1892 Painter B65D 41/12
215/324
D108,353 S * 2/1938 Young D9/445
(Continued)

OTHER PUBLICATIONS

Coca Cola Bottle Cap: Announced Mar. 7, 2011 [online]. Site Visited [Dec. 8, 2019]. Available from Internet URL: <https://www.turbosquid.com/3d-models/3d-coca-cola-bottle-cap-model/591203>.*

(Continued)

Primary Examiner — Catherine S Posthauer

(74) *Attorney, Agent, or Firm* — Schmeiser, Olsen & Watts LLP

(57) **CLAIM**

The ornamental design for a “bottle cap”, as shown and described.

DESCRIPTION

FIG. 1 is a top perspective view of a front and top face of a bottle cap;
FIG. 2 is a bottom perspective view of a front and bottom face of the bottle cap of FIG. 1;
FIG. 3 is top view of the bottle cap of FIG. 1;
FIG. 4 is a bottom view of the bottle cap of FIG. 1;
FIG. 5 is a front view of the bottle cap of FIG. 1;
FIG. 6 is a rear view of the bottle cap of FIG. 1;
FIG. 7 is a left side view of the bottle cap of FIG. 1;
FIG. 8 is a right side view of the bottle cap of FIG. 1;
FIG. 9 is a cross-sectional view of the bottle cap, taken in the direction of line 9-9 on FIG. 3; and,
FIG. 10 is an enlargement view taken from within line 10 on FIG. 9.

The broken lines shown on FIGS. 9 and 10 represent the designation of enlargement views and form no part of the claimed design.

1 Claim, 4 Drawing Sheets

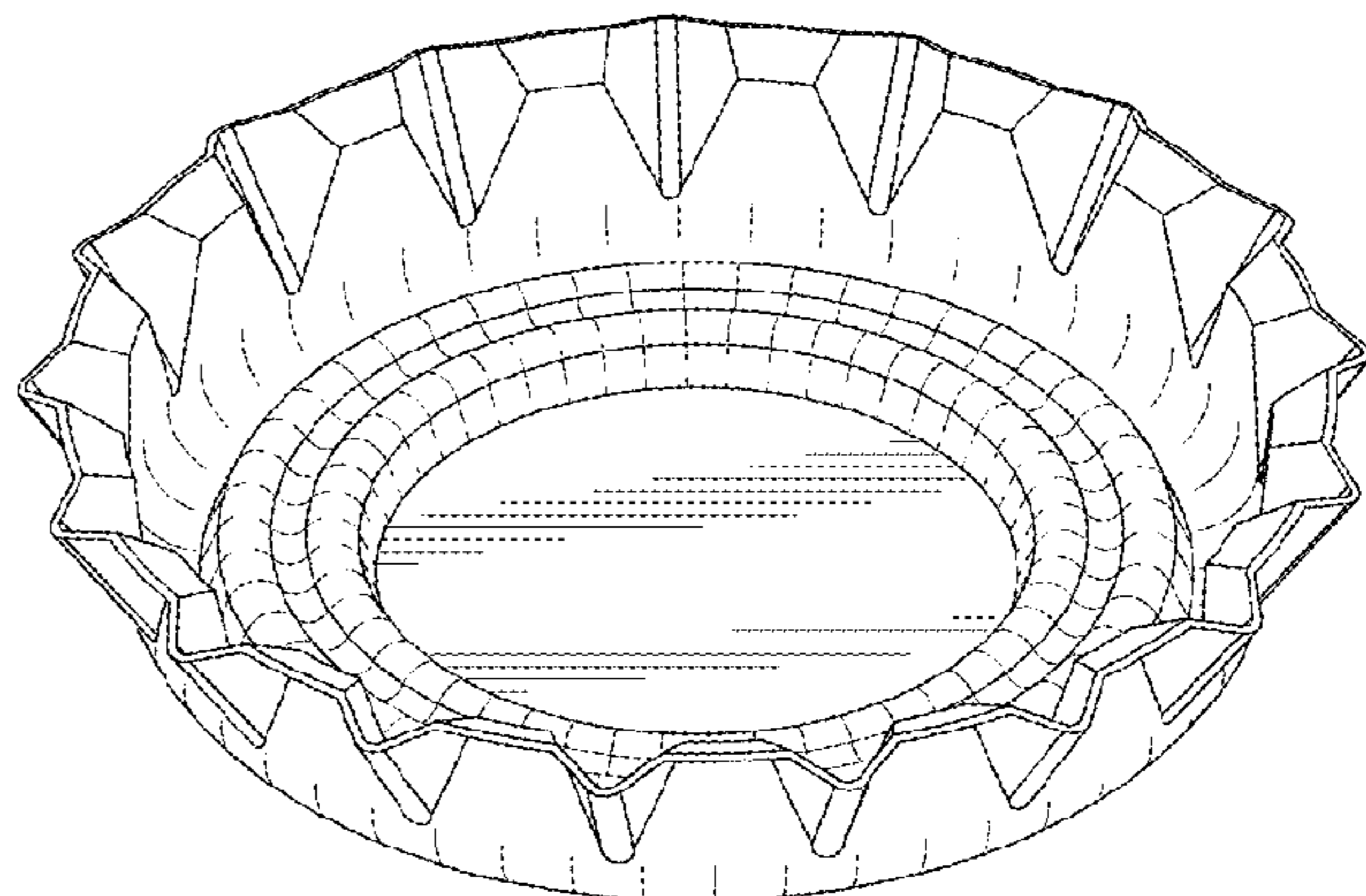
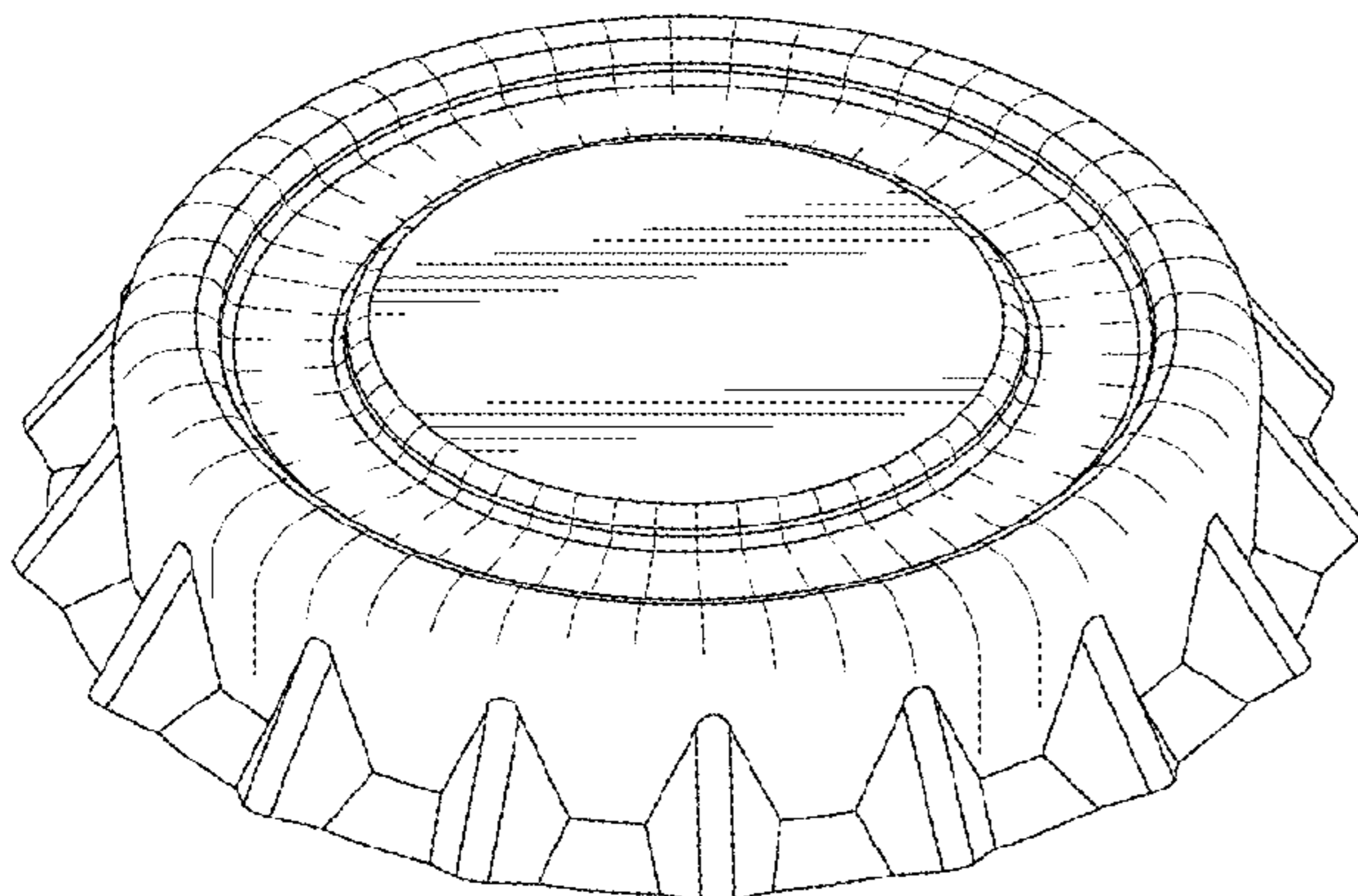

(58) **Field of Classification Search**

CPC B65D 51/2821; B65D 21/0228; B65D 41/3447; B65D 1/02; B65D 50/041; B65D 2215/02; A61L 9/12; A47G 19/2205; A47G 19/2222; A47G 19/2266; A47G 19/2272; A47G 19/2294; A47G 19/22; A47J 43/27; B05B 7/2437; B05C 17/00576; E03F 5/02; A61M 35/003; A01M 1/02; A01M 1/04; A01M 1/106

See application file for complete search history.

(56) **References Cited**

U.S. PATENT DOCUMENTS

3,198,369 A * 8/1965 St. Jacques B65D 41/12
215/328
3,200,982 A * 8/1965 Cormier B65D 41/42
215/253
3,281,001 A * 10/1966 Stuart B65D 41/42
215/254
3,547,746 A * 12/1970 Gwinner B29C 43/18
428/172
3,774,795 A * 11/1973 Leenaards B65D 1/0246
215/328
4,337,871 A * 7/1982 Tucker B65D 41/12
215/328
5,263,600 A * 11/1993 Henning B65D 41/0464
215/295
D363,075 S * 10/1995 Dunn D15/90
5,806,700 A * 9/1998 Henning B65D 1/0246
215/238
6,006,933 A * 12/1999 Henning B65D 41/12
215/326
6,179,141 B1 * 1/2001 Nakamura B65D 1/023
215/261
6,183,827 B1 * 2/2001 Folchini B65D 41/12
428/64.1
D462,506 S * 9/2002 Davison, III D2/869

D470,413 S * 2/2003 Seidita D9/452
D485,179 S * 1/2004 Kouri D9/435
D495,255 S * 8/2004 Lewis D9/436
D513,587 S * 1/2006 Forte D9/435
D516,426 S * 3/2006 Golding D9/452
D548,016 S * 8/2007 Jackson D7/625
D585,202 S * 1/2009 Curtis D6/351
D587,579 S * 3/2009 Bourque D9/452
D644,822 S * 9/2011 Keppler D2/870
D670,166 S * 11/2012 Lavender D9/452
8,322,549 B2 * 12/2012 Bourque B65D 41/12
215/324
D673,851 S * 1/2013 Yates D9/452
D799,961 S * 10/2017 Yu D9/452
D848,842 S * 5/2019 Ramsey D9/452
D853,215 S * 7/2019 Bellamy, Sr. D8/40
D855,462 S * 8/2019 Ramsey D9/452
D859,733 S * 9/2019 Sharp D27/118
2004/0074863 A1 * 4/2004 Ramsey B65D 41/12
215/327
2005/0029218 A1 * 2/2005 Golding B65D 41/12
215/328
2009/0266784 A1 * 10/2009 Garuti B65D 41/42
215/316

OTHER PUBLICATIONS

3D Model Beer Cap: Announced Jan. 7, 2019 [online]. Site Visited [Dec. 8, 2019]. Available from Interent URL: <https://www.turbosquid.com/3d-models/3d-model-beer-cap-1363947>.*

New Bottle Cap: Announced Jun. 30, 2015 [online]. Site Visited [Dec. 8, 2019]. Available from Internet URL: <https://www.turbosquid.com/3d-models/3d-model-of-new-bottle-cap/940141>.*

3D Bottle Cap: Announced Sep. 22, 2019 [online]. Site Visited [Dec. 9, 2019]. Available from Internet URL: <https://www.turbosquid.com/3d-models/3d-bottle-cap-1450999>.*

3D Bottle Cap: Announced Jan. 5, 2018 [online]. Site Visited [Dec. 8, 2019]. Available from Internet URL: <https://www.turbosquid.com/FullPreview/Index.cfm/ID/1243627>.*

* cited by examiner

FIG. 1

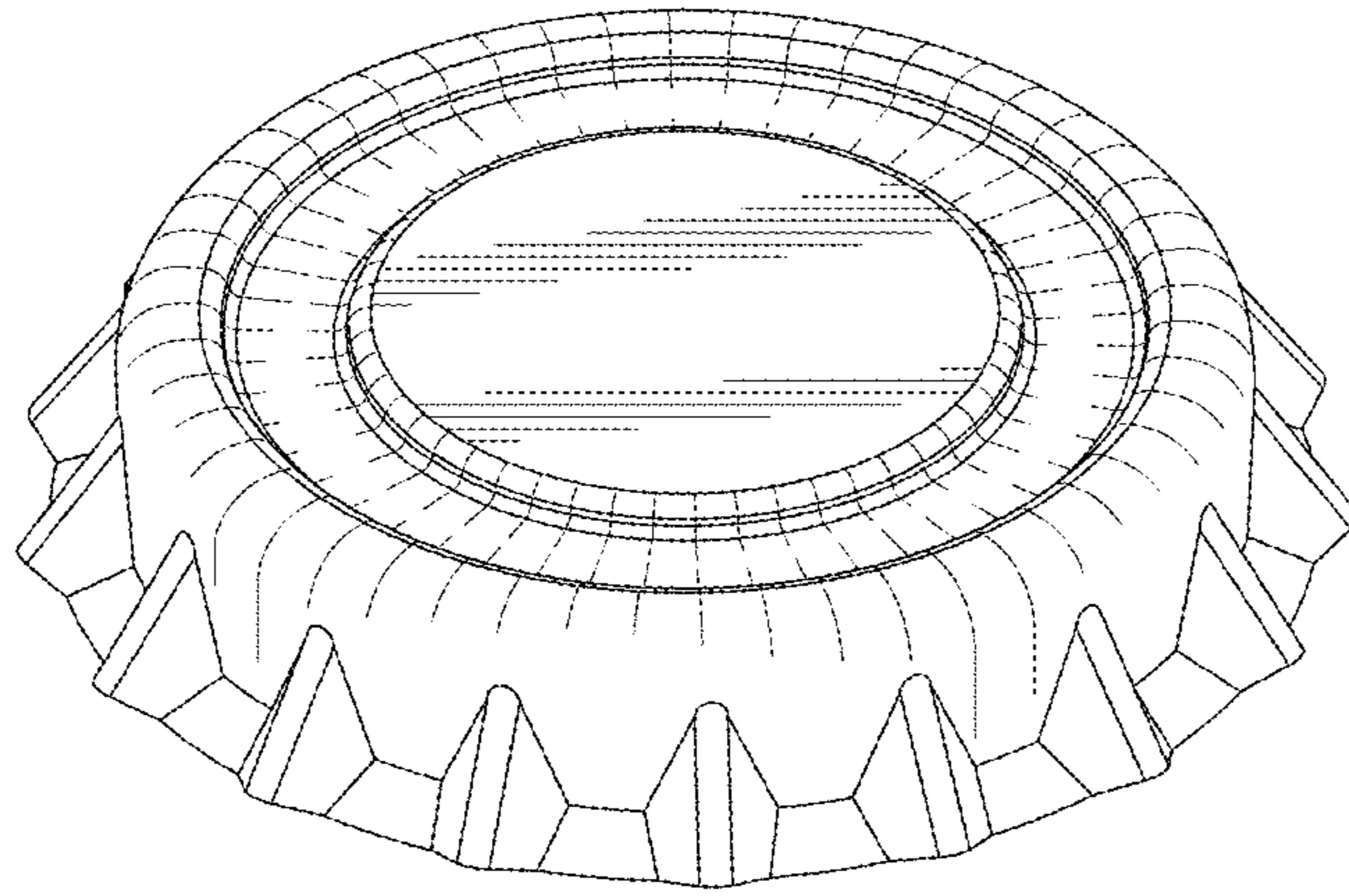

FIG. 2

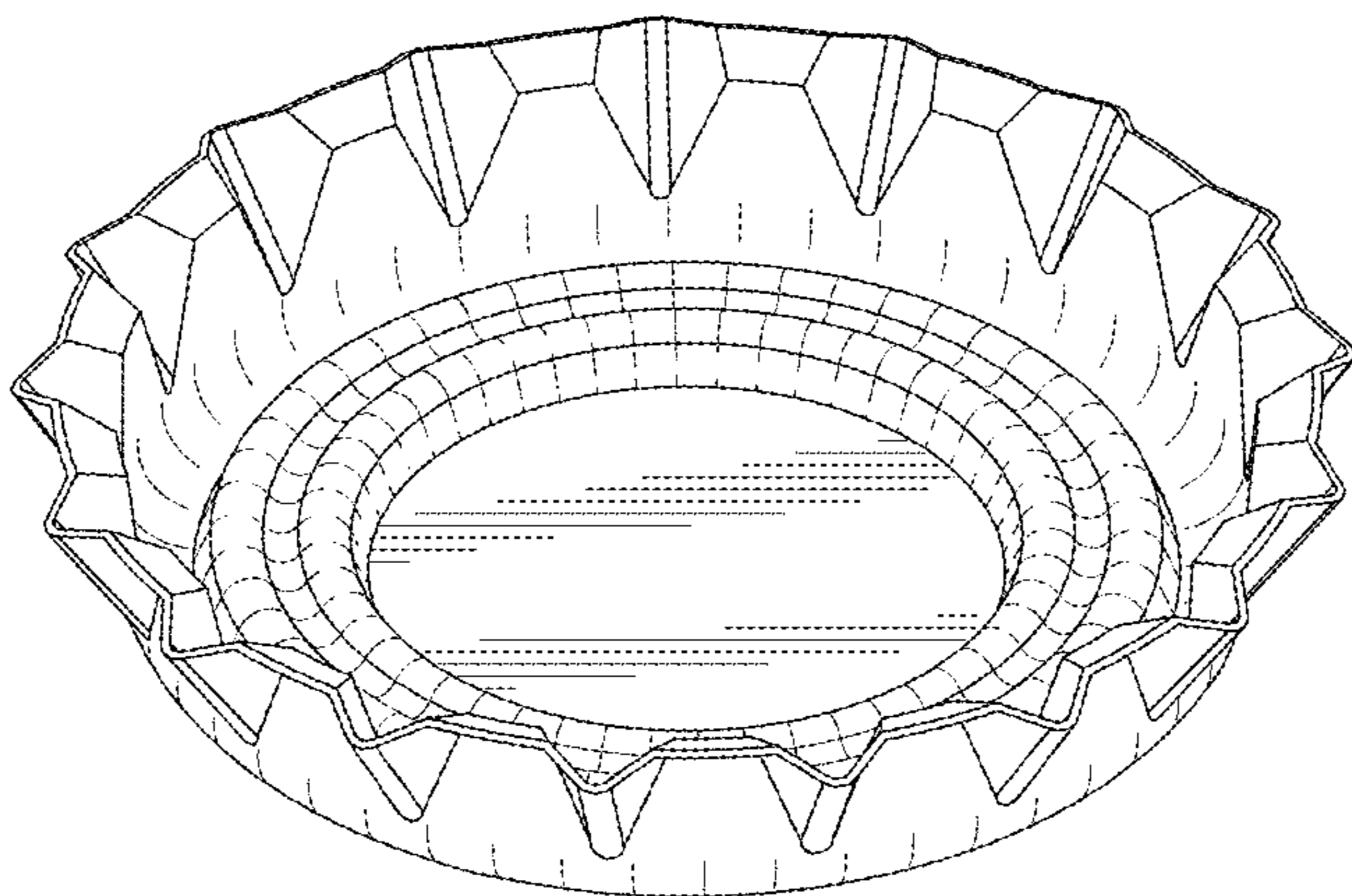

FIG. 3

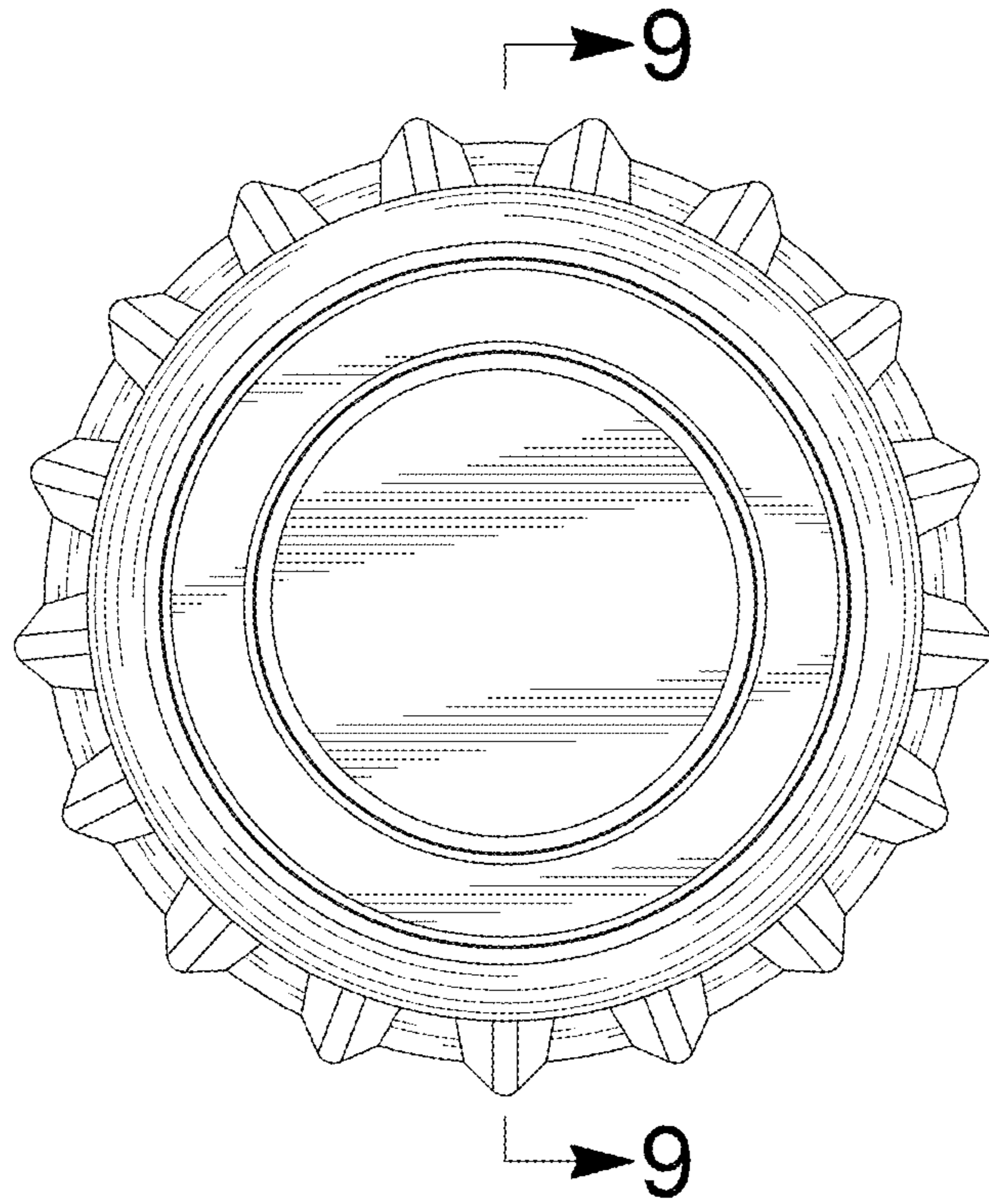

FIG. 4

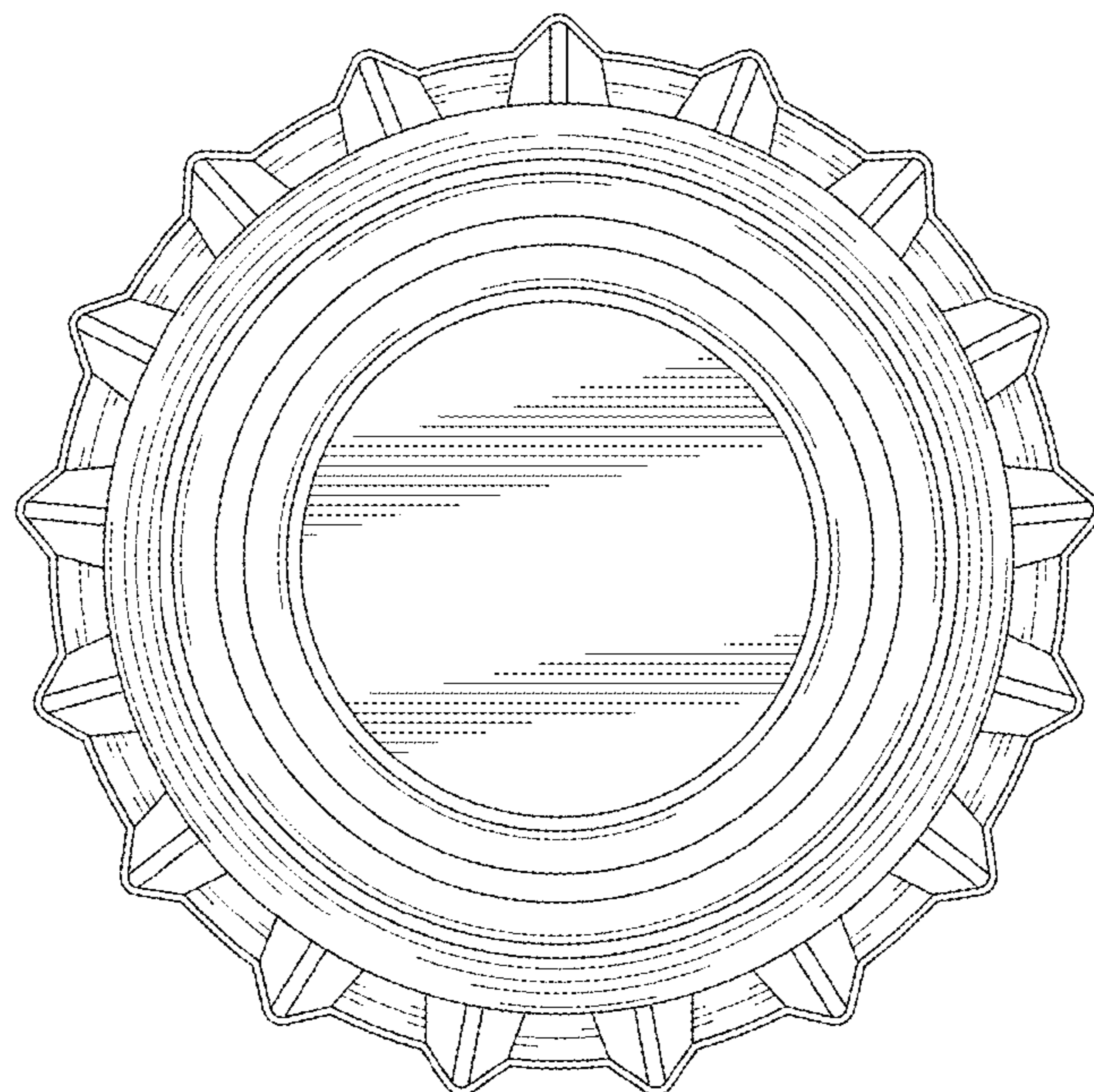

FIG. 5

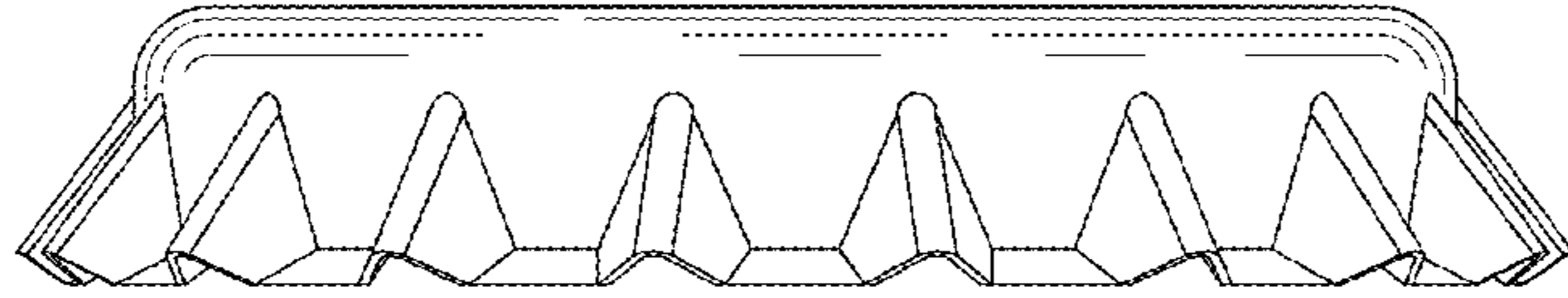

FIG. 6

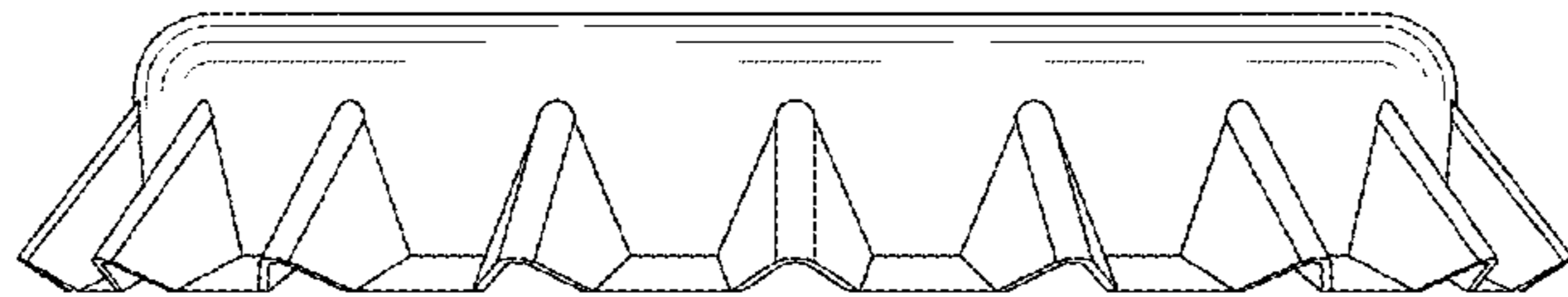

FIG. 7



FIG. 8

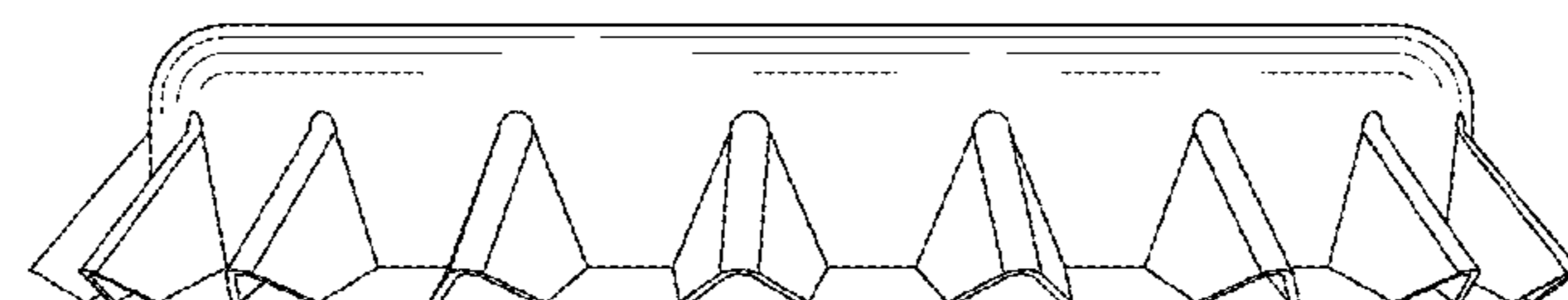

FIG. 9

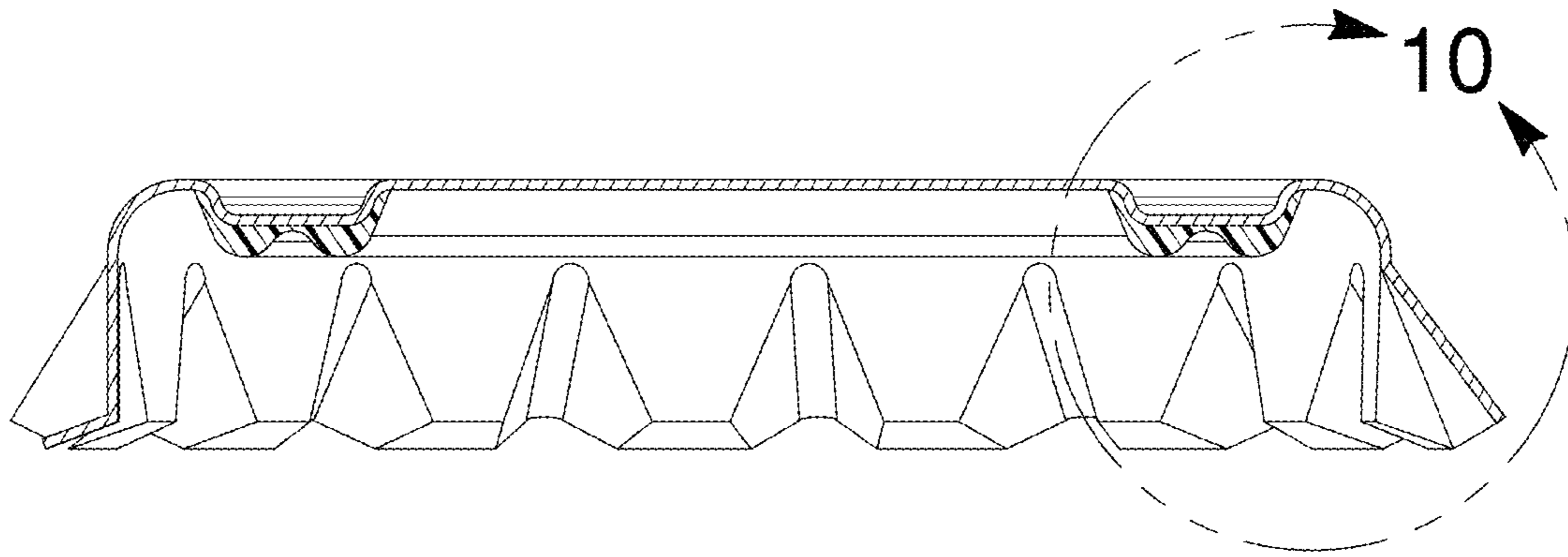

FIG. 10

