



US00D894735S

(12) **United States Design Patent**  
**Merino**

(10) **Patent No.:** **US D894,735 S**

(45) **Date of Patent:** **\*\* \*Sep. 1, 2020**

(54) **BOTTLE CAP**

(71) Applicant: **Packaging Products del Peru S.A.**,  
Lima (PE)

(72) Inventor: **Alfredo Abel Merino**, Lima (PE)

(73) Assignees: **Alfredo Abel Merino**, Lima (PE);  
**Roberto Carlos Martínez**, Lima (PE)

(\*) Notice: This patent is subject to a terminal disclaimer.

(\*\*) Term: **15 Years**

(21) Appl. No.: **29/658,727**

(22) Filed: **Aug. 2, 2018**

(51) **LOC (12) Cl.** ..... **09-07**

(52) **U.S. Cl.**  
USPC ..... **D9/452**

(58) **Field of Classification Search**  
USPC ..... D3/202, 203.1, 203.2, 318; D7/300,  
D7/300.1, 316, 317, 323, 354, 387, 391,  
D7/392, 392.1, 393, 396.1, 396.2, 396.4,  
D7/397, 398, 503, 509, 510, 511, 523,  
D7/526-531, 538, 566, 568, 600.1, 602,  
D7/603, 614, 619.1, 629, 704, 900;  
D9/434, 435, 440, 447, 452, 453, 454,  
D9/499, 516, 529, 686, 723, 433, 445,  
D9/456; D24/121, 127, 199, 224;  
D23/249, 259, 260, 261; D8/14, 14.1,  
D8/45, 300, 307, 343, 354, 400, 402;  
D15/138, 143; D34/7, 10, 11; D28/76,  
D28/84, 85, 91.1; D19/192, 194  
CPC ..... B65D 2517/5091; B65D 41/04; B65D  
23/12; B65D 1/0246; B65D 47/265;  
B65D 47/065; B65D 51/24; B65D  
51/224; B65D 51/245; B65D 2101/0015;  
B65D 2251/0093; B65D 85/72; B65D  
51/18; B65D 51/28; B65D 51/242; B65D  
51/2814;

(Continued)

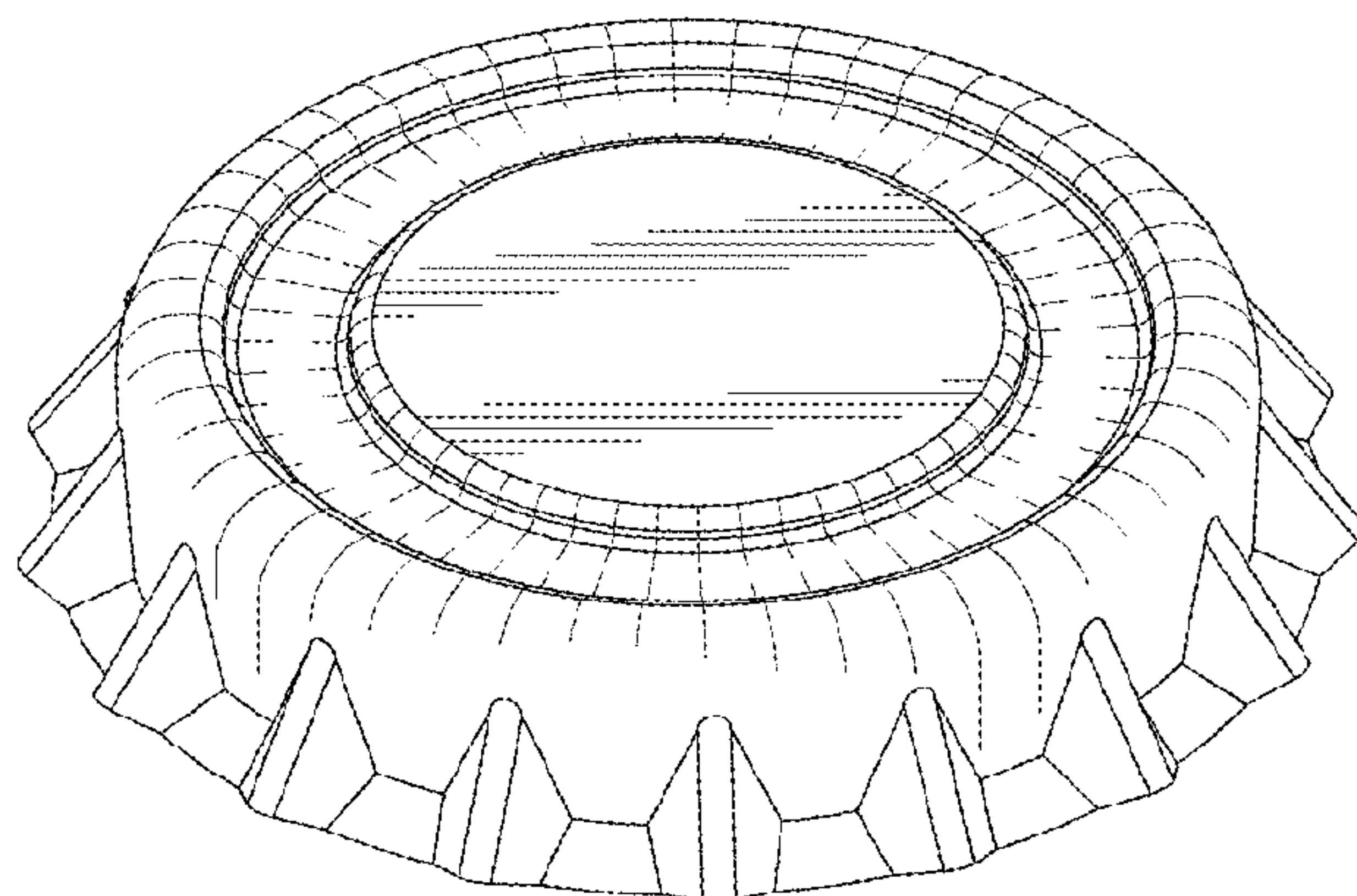

(56) **References Cited**

U.S. PATENT DOCUMENTS

468,226 A \* 2/1892 Painter ..... B65D 41/12  
215/324  
D108,353 S \* 2/1938 Young ..... D9/445  
(Continued)

OTHER PUBLICATIONS

Coca Cola Bottle Cap: Announced Mar. 7, 2011 [online]. Site Visited [Dec. 8, 2019]. Available from Internet URL: <https://www.turbosquid.com/3d-models/3d-coca-cola-bottle-cap-model/591203>.\*

(Continued)

*Primary Examiner* — Catherine S Posthauer

(74) *Attorney, Agent, or Firm* — Schmeiser, Olsen & Watts LLP

(57) **CLAIM**

The ornamental design for a “bottle cap,” as shown and described.

**DESCRIPTION**

FIG. 1 is a top perspective view of a front and top face of a bottle cap;  
FIG. 2 is a bottom perspective view of a front and bottom face of the bottle cap of FIG. 1;  
FIG. 3 is top view of the bottle cap of FIG. 1;  
FIG. 4 is a bottom view of the bottle cap of FIG. 1;  
FIG. 5 is a front view of the bottle cap of FIG. 1;  
FIG. 6 is a rear view of the bottle cap of FIG. 1;  
FIG. 7 is a left side view of the bottle cap of FIG. 1;  
FIG. 8 is a right side view of the bottle cap of FIG. 1;  
FIG. 9 is a cross-sectional view of the bottle cap, taken in the direction of line 9-9 on FIG. 3; and,  
FIG. 10 is an enlargement view taken from within line 10 on FIG. 9.

(Continued)

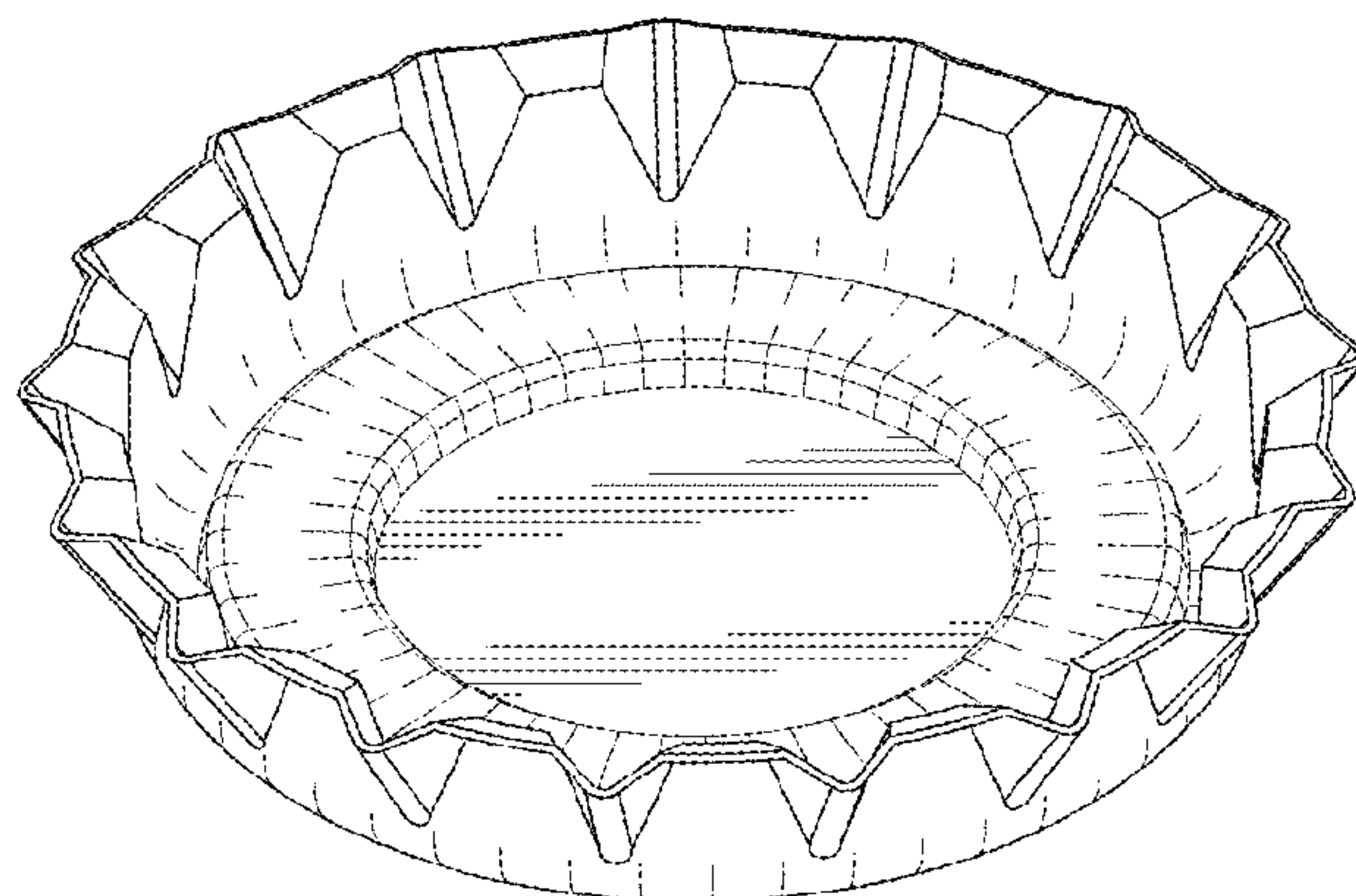

The broken lines shown on FIGS. 9 and 10 represent the designation of enlargement views and form no part of the claimed design.

**1 Claim, 4 Drawing Sheets**

(58) **Field of Classification Search**

CPC ..... B65D 51/2821; B65D 21/0228; B65D 41/3447; B65D 1/02; B65D 50/041; B65D 2215/02; A61L 9/12; A47G 19/2205; A47G 19/2222; A47G 19/2266; A47G 19/2272; A47G 19/2294; A47G 19/22; A47J 43/27; B05B 7/2437; B05C 17/00576; E03F 5/02; A61M 35/003; A01M 1/02; A01M 1/04; A01M 1/106

See application file for complete search history.

(56) **References Cited**

U.S. PATENT DOCUMENTS

3,198,369	A *	8/1965	St. Jacques	.....	B65D 41/12 215/328
3,200,982	A *	8/1965	Cormier	.....	B65D 41/42 215/253
3,281,001	A *	10/1966	Stuart	.....	B65D 41/42 215/254
3,547,746	A *	12/1970	Gwinner	.....	B29C 43/18 428/172
3,774,795	A *	11/1973	Leenaards	.....	B65D 1/0246 215/328
4,337,871	A *	7/1982	Tucker	.....	B65D 41/12 215/328
5,263,600	A *	11/1993	Henning	.....	B65D 41/0464 215/295
D363,075	S *	10/1995	Dunn	.....	D15/90
5,806,700	A *	9/1998	Henning	.....	B65D 1/0246 215/238
6,006,933	A *	12/1999	Henning	.....	B65D 41/12 215/326
6,179,141	B1 *	1/2001	Nakamura	.....	B65D 1/023 215/261

6,183,827	B1 *	2/2001	Folchini	.....	B65D 41/12 428/64.1
D462,506	S *	9/2002	Davison, III	.....	D2/869
D470,413	S *	2/2003	Seidita	.....	D9/452
D485,179	S *	1/2004	Kouri	.....	D9/435
D495,255	S *	8/2004	Lewis	.....	D9/436
D513,587	S *	1/2006	Forte	.....	D9/435
D516,426	S *	3/2006	Golding	.....	D9/452
D548,016	S *	8/2007	Jackson	.....	D7/625
D585,202	S *	1/2009	Curtis	.....	D6/351
D587,579	S *	3/2009	Bourque	.....	D9/452
D644,822	S *	9/2011	Kepler	.....	D2/870
D670,166	S *	11/2012	Lavender	.....	D9/452
8,322,549	B2 *	12/2012	Bourque	.....	B65D 41/12 215/324
D673,851	S *	1/2013	Yates	.....	D9/452
D799,961	S *	10/2017	Yu	.....	D9/452
D848,842	S *	5/2019	Ramsey	.....	D9/452
D853,215	S *	7/2019	Bellamy, Sr.	.....	D8/40
D855,462	S *	8/2019	Ramsey	.....	D9/452
D859,733	S *	9/2019	Sharp	.....	D27/118
2004/0074863	A1 *	4/2004	Ramsey	.....	B65D 41/12 215/327
2005/0029218	A1 *	2/2005	Golding	.....	B65D 41/12 215/328
2009/0266784	A1 *	10/2009	Garuti	.....	B65D 41/42 215/316

OTHER PUBLICATIONS

3D Model Beer Cap: Announced Jan. 7, 2019 [online]. Site Visited [Dec. 8, 2019]. Available from Interent URL: <https://www.turbosquid.com/3d-models/3d-model-beer-cap-1363947>.\*

New Bottle Cap: Announced Jun. 30, 2015 [online]. Site Visited [Dec. 8, 2019]. Available from Internet URL: <https://www.turbosquid.com/3d-models/3d-model-of-new-bottle-cap/940141>.\*

3D Bottle Cap: Announced Sep. 22, 2019 [online]. Site Visited [Dec. 9, 2019]. Available from Internet URL: <https://www.turbosquid.com/3d-models/3d-bottle-cap-1450999>.\*

3D Bottle Cap: Announced Jan. 5, 2018 [online]. Site Visited [Dec. 8, 2019]. Available from Internet URL: <https://www.turbosquid.com/FullPreview/Index.cfm/ID/1243627>.\*

\* cited by examiner



FIG. 1

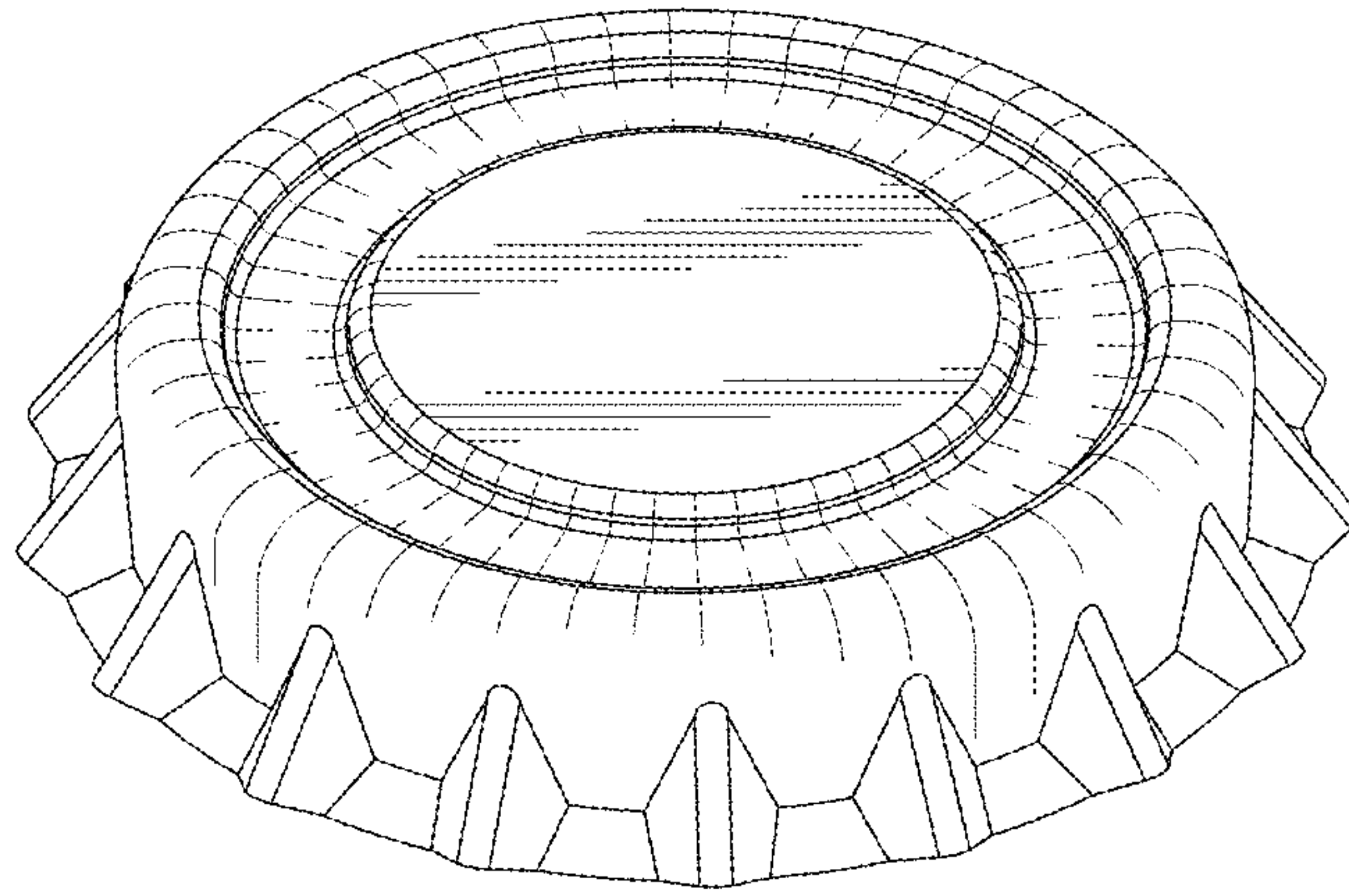

FIG. 2

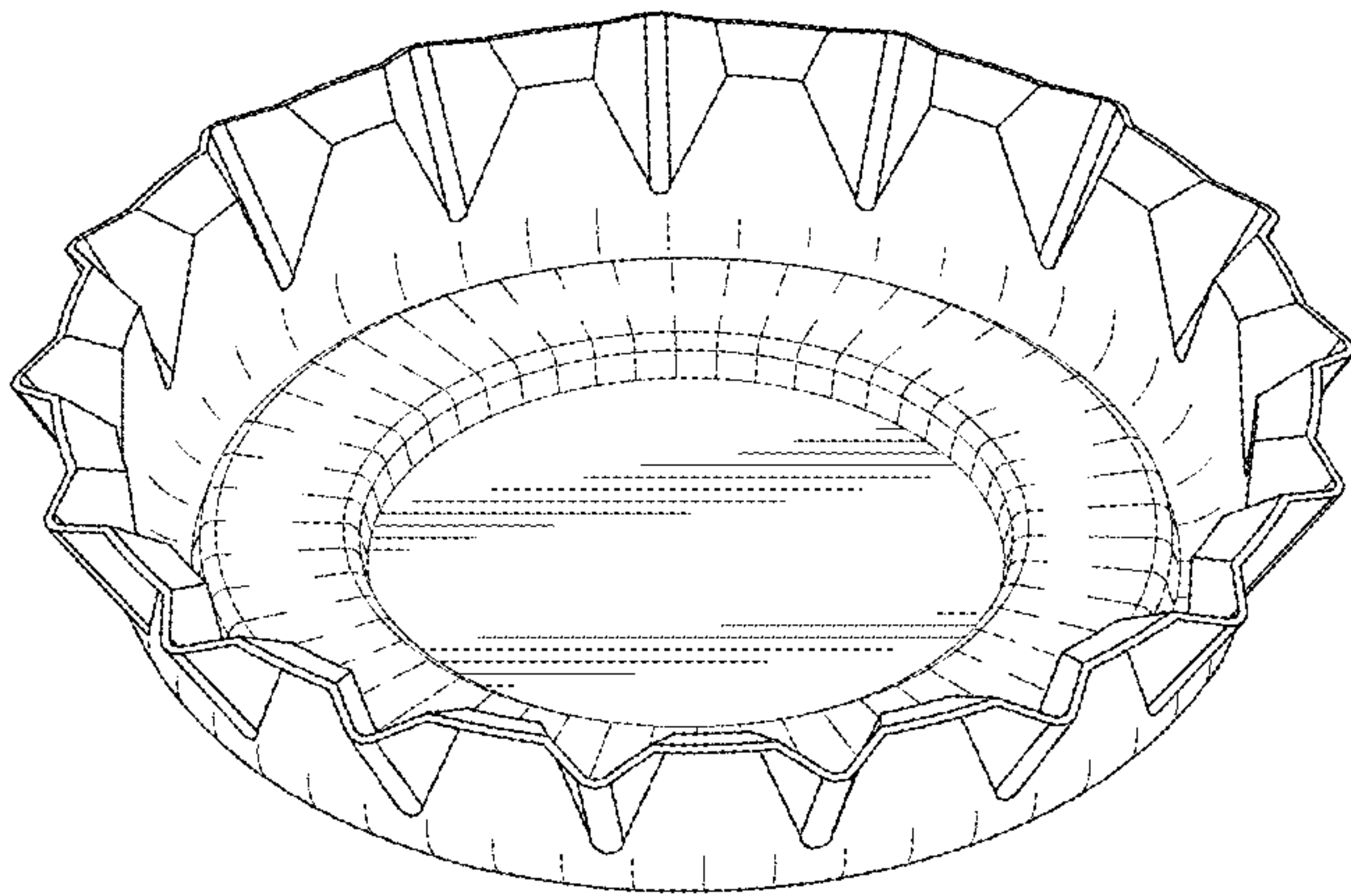

FIG. 3

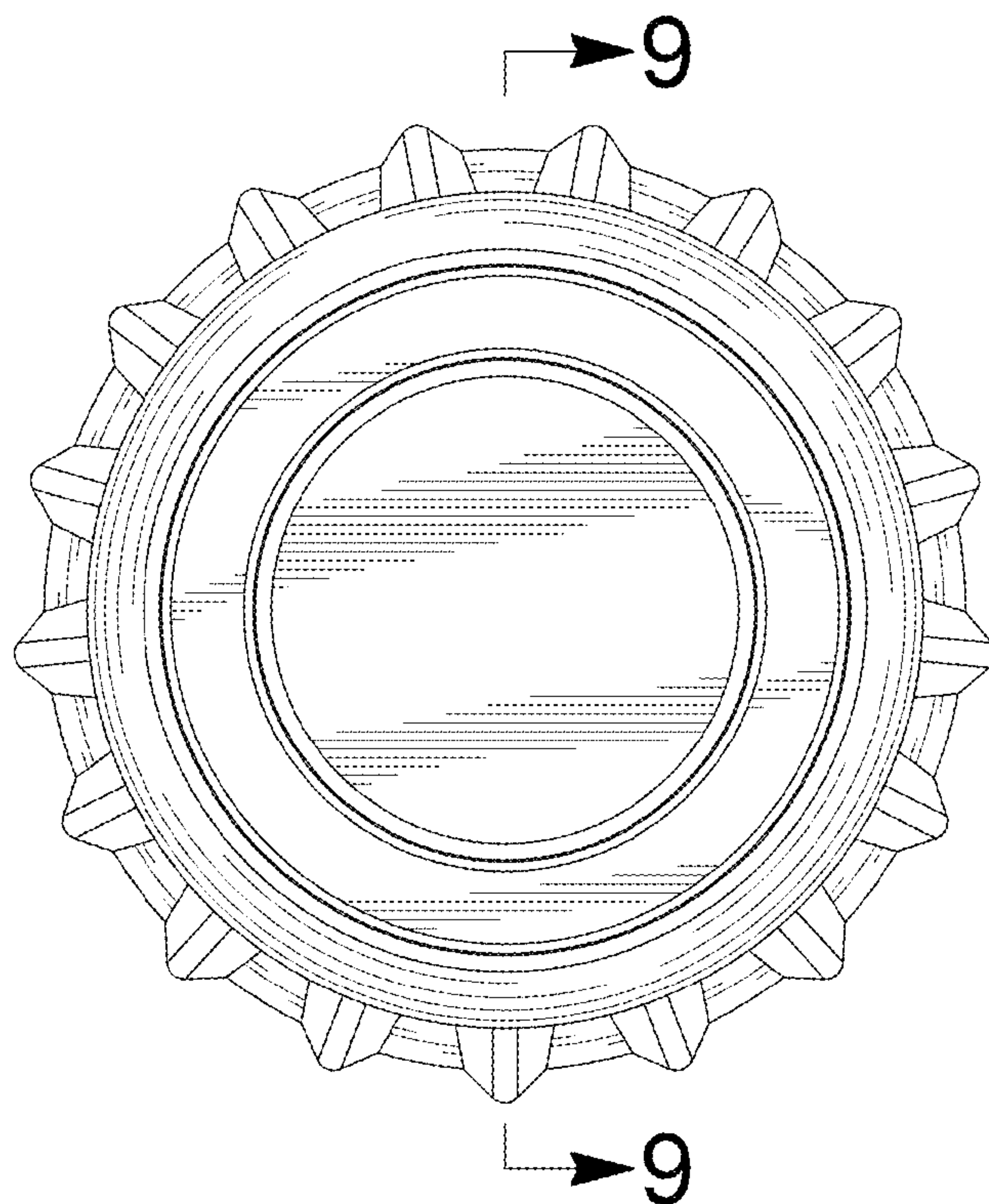

FIG. 4

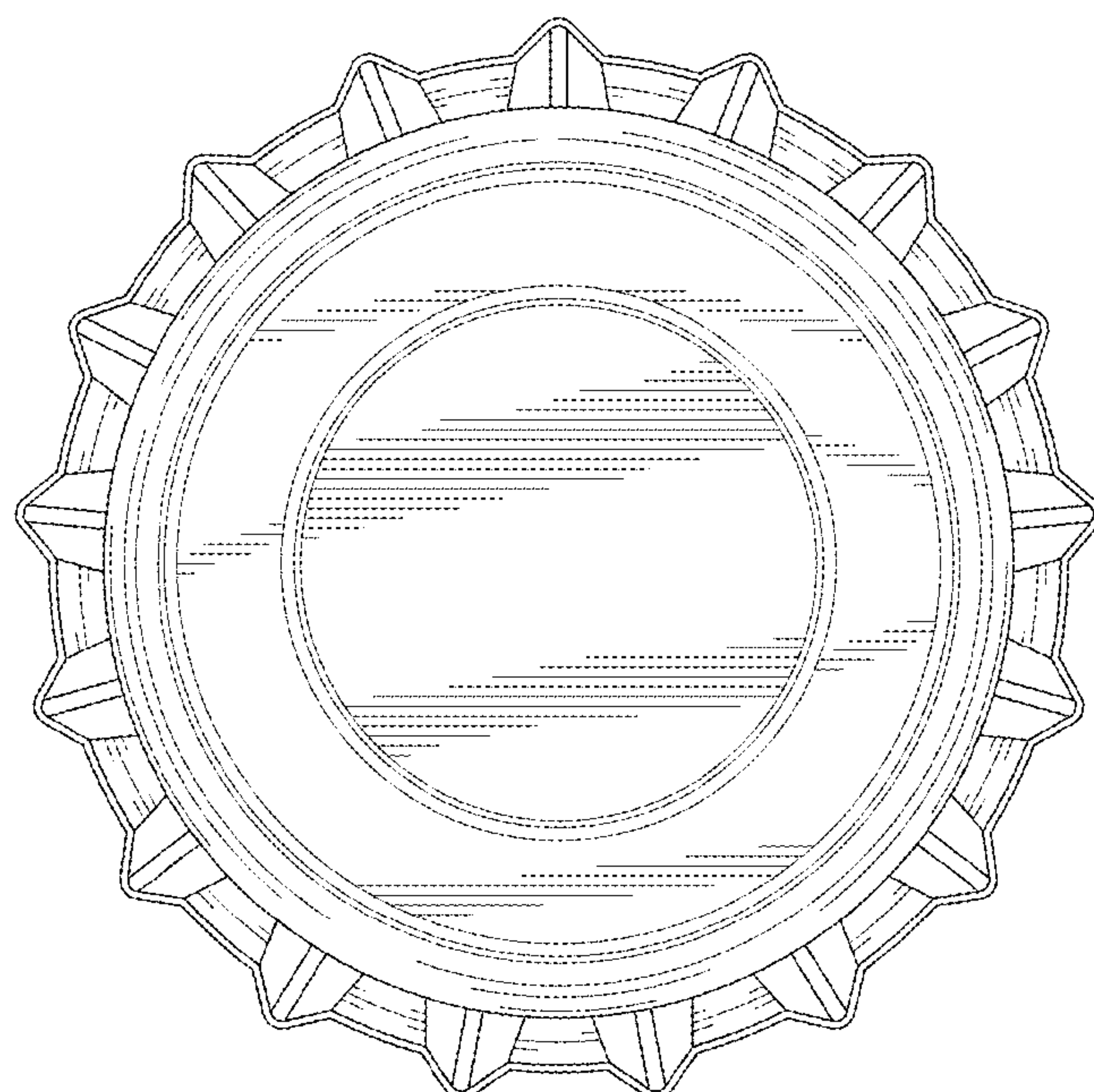

FIG. 5

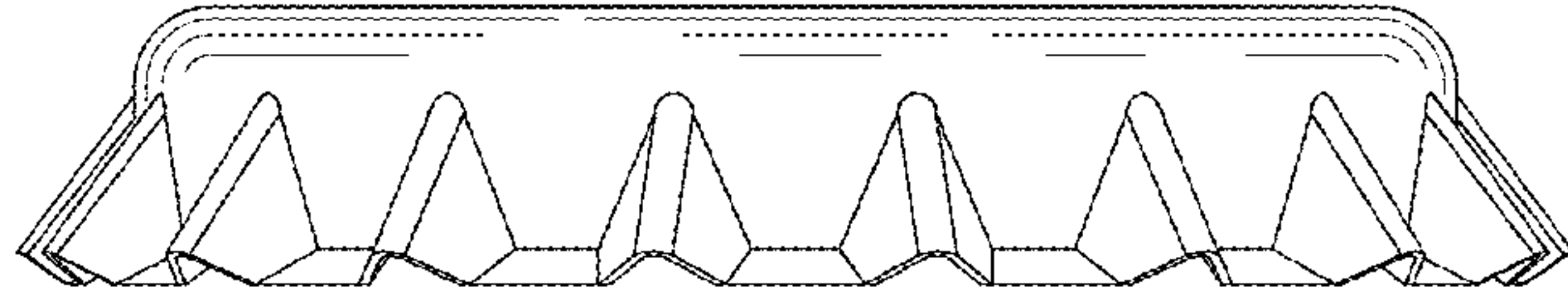

FIG. 6

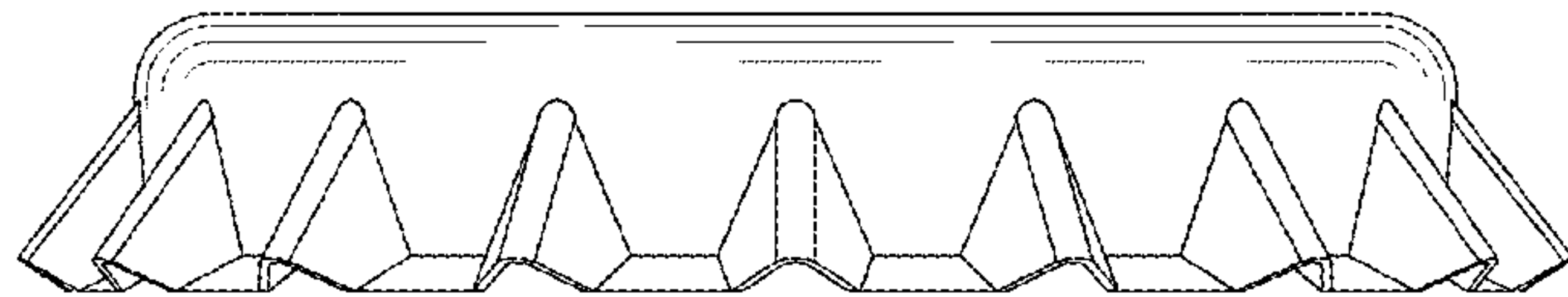

FIG. 7

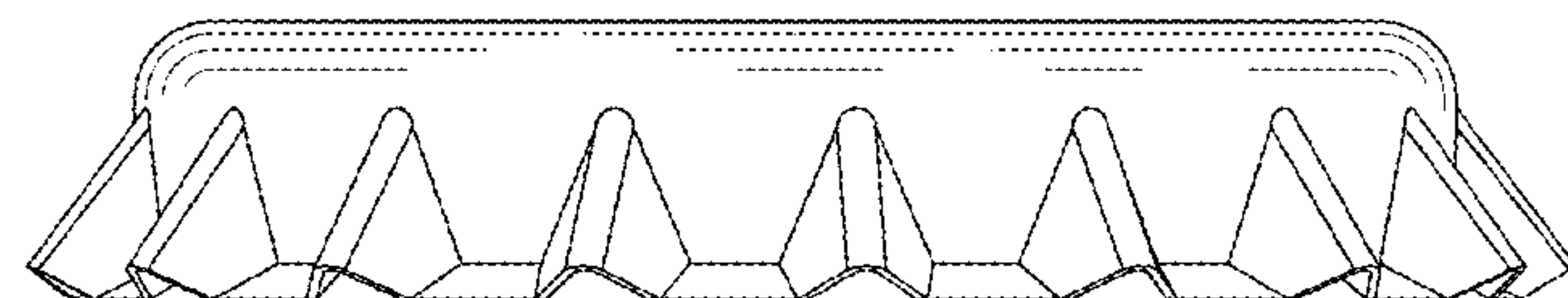

FIG. 8

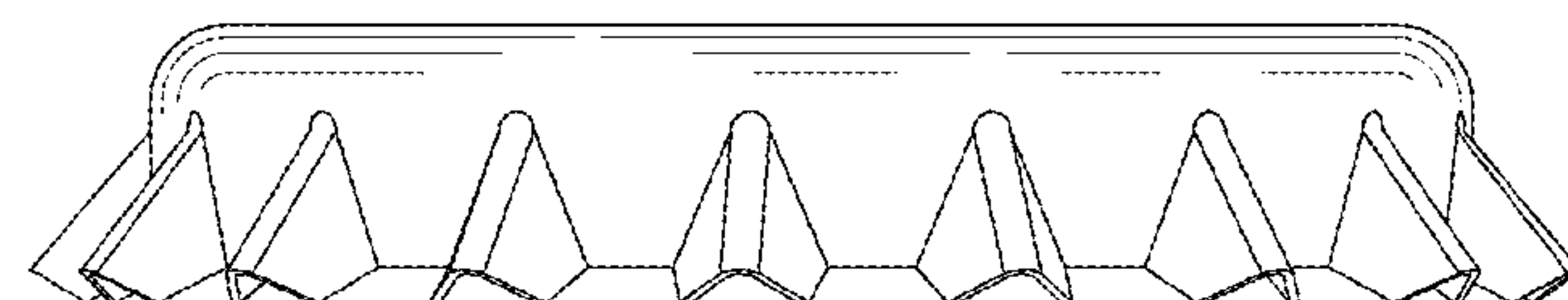

FIG. 9

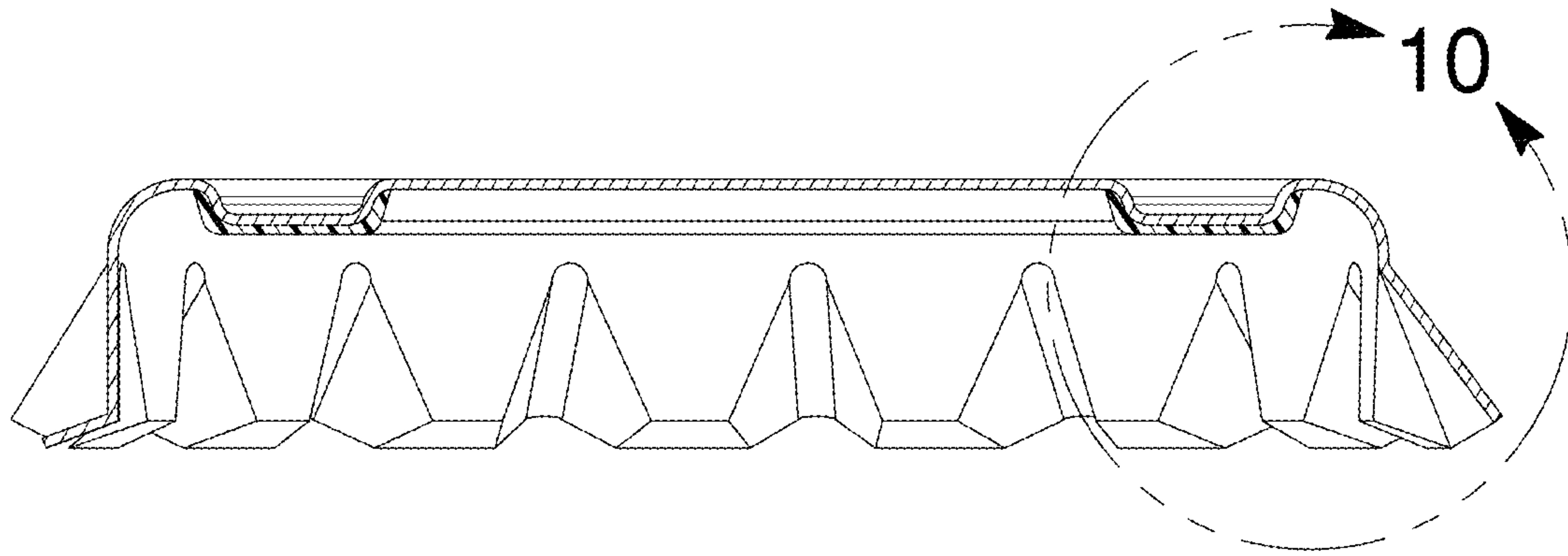

FIG. 10

