



US00D894722S

(12) **United States Design Patent** (10) **Patent No.:** **US D894,722 S**
Stacey et al. (45) **Date of Patent:** **** Sep. 1, 2020**

- (54) **STRAP OF A CONNECTING MECHANISM**
- (71) Applicant: **M-R Products, Inc.**, Copemish, MI (US)
- (72) Inventors: **Dennis Stacey**, Copemish, MI (US); **Maree Mulvoy**, Copemish, MI (US)
- (73) Assignee: **M-R PRODUCTS, INC.**, Copemish, MI (US)
- (**) Term: **15 Years**
- (21) Appl. No.: **29/601,051**
- (22) Filed: **Apr. 18, 2017**
- (51) **LOC (12) Cl.** **08-08**
- (52) **U.S. Cl.**
USPC **D8/383**; D8/382
- (58) **Field of Classification Search**
USPC D8/382, 383, 349, 354, 394, 396; D23/262
CPC F16G 11/00; F16G 1/00; B65D 63/00; B65D 63/10; B65D 63/1018; Y10T 24/34; Y10T 24/312; Y10T 24/4084; Y10T 24/45199; Y10T 24/45215; F16L 3/08; F16L 3/1058; F16L 3/137; F16L 3/233; F16L 37/148; F16B 1/00; F16B 2/20; F16B 2001/0028; F16B 2/22
See application file for complete search history.

- (56) **References Cited**
U.S. PATENT DOCUMENTS
535,502 A * 3/1895 Knighton B65D 63/10 24/16 R
D189,422 S * 12/1960 Zeek D21/774
D253,992 S * 1/1980 Nelson D8/356
D287,983 S * 1/1987 Picozza D21/392
4,728,064 A * 3/1988 Caveney B65D 63/1081 248/74.3
D316,811 S * 5/1991 Paul D6/300

- 5,195,217 A * 3/1993 Arntzen A01K 27/005 24/115 F
- 5,575,044 A * 11/1996 Zornes A41F 9/002 24/168
- D382,431 S * 8/1997 Parra D6/546
- D400,686 S * 11/1998 Hamerman D2/610
- 5,987,706 A * 11/1999 Boe B65D 63/1018 24/16 PB

(Continued)

Primary Examiner — Sandra S Snapp
Assistant Examiner — Ieisha N Price
(74) *Attorney, Agent, or Firm* — Fishman Stewart PLLC

(57) **CLAIM**

The ornamental design for a strap of a connecting mechanism, as shown and described.

DESCRIPTION

FIG. 1 is a front perspective view of the first embodiment of a strap of a connecting mechanism;
FIG. 2 is a front view of FIG. 1;
FIG. 3 is a back view of FIG. 1;
FIG. 4 is a top plan view of a strap of FIG. 1;
FIG. 5 is a left side view of FIG. 1;
FIG. 6 is a right side view of FIG. 1;
FIG. 7 is a front perspective view of the second embodiment of a strap of a connecting mechanism showing environment;
FIG. 8 is a front view of FIG. 7;
FIG. 9 is a back view of FIG. 7;
FIG. 10 is a top plan view of FIG. 7;
FIG. 11 is a bottom view of FIG. 7;
FIG. 12 is a left side view of FIG. 7; and,
FIG. 13 is a right side view of FIG. 7.
The broken lines shown in FIGS. 7-13 illustrate environment of the claimed design and form no part thereof. The strap of a connecting mechanism is shown with a symbolic break in its length. The appearance of any portion of the article between the break lines forms no part of the claimed design.

1 Claim, 4 Drawing Sheets

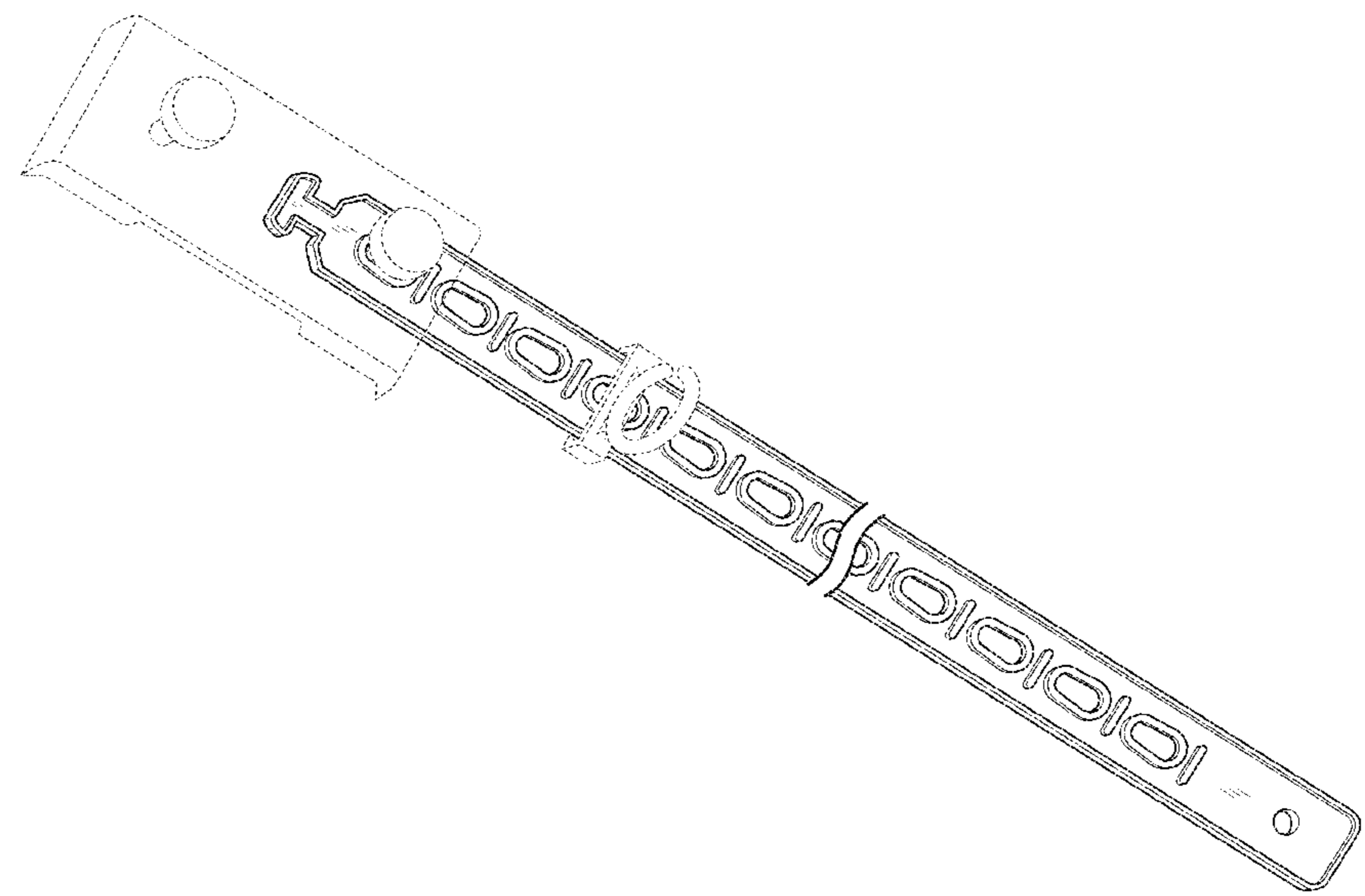

(56)

References Cited

U.S. PATENT DOCUMENTS

D448,658 S *	10/2001	Farina	D8/382	D814,906 S *	4/2018	Pine	D8/349
D450,561 S *	11/2001	Moore	D11/200	D823,672 S *	7/2018	Mogensen	D8/356
6,317,935 B1 *	11/2001	O'Rourke	A62B 1/04	D840,795 S *	2/2019	Tribbett	B65D 63/109
				24/115 K					D8/383
6,349,904 B1 *	2/2002	Polad	F16L 3/137	D846,372 S *	4/2019	Wu	D8/373
				24/16 PB	D848,615 S *	5/2019	McNeill	D24/128
6,401,305 B1 *	6/2002	Joseph	F16L 3/233	D848,616 S *	5/2019	McNeill	D24/128
				24/16 R	10,456,520 B2 *	10/2019	McNeill	A61G 7/0503
D485,487 S *	1/2004	Bryant, Jr.	D8/382	2008/0011907 A1 *	1/2008	Jacobsma	F16L 33/035
D511,087 S *	11/2005	Okamoto	D8/354					248/62
D513,973 S *	1/2006	Cheung	D8/394	2011/0252606 A1 *	10/2011	Rothbaum	F16G 11/00
D531,890 S *	11/2006	Bentrim	D8/382					24/302
D540,156 S *	4/2007	Bryant	D8/367	2012/0042481 A1 *	2/2012	Kempf	H02G 1/06
D552,979 S *	10/2007	Wong	D8/383					24/116 R
D564,869 S *	3/2008	Peterson	D8/382	2013/0205545 A1 *	8/2013	Zantout	B65D 63/00
D615,385 S *	5/2010	Arendt	D8/349					24/16 R
D712,239 S *	9/2014	Yoshizawa	D8/382	2014/0082923 A1 *	3/2014	Owen	B65D 63/1027
D714,631 S *	10/2014	Frydlewski	D8/394					29/525.03
D729,041 S *	5/2015	Smith	D8/349	2014/0096344 A1 *	4/2014	Creto	B65D 85/04
D752,333 S *	3/2016	Van Der Pol	D2/978					24/16 PB
D789,776 S *	6/2017	Stacey	D10/121	2015/0166236 A1 *	6/2015	Comaniuk	F16L 3/137
D796,942 S *	9/2017	Uimonen	D8/382					24/16 R
D797,300 S *	9/2017	Schneider	D11/220	2016/0340093 A1 *	11/2016	Muller	F16L 33/035
D798,136 S *	9/2017	Pittman	D8/382	2017/0129650 A1 *	5/2017	Karas	F16B 2/22
D798,698 S *	10/2017	Shih	D8/383	2017/0219127 A1 *	8/2017	Vermillion	F16L 3/137
9,895,485 B1 *	2/2018	McNeill	A61M 5/1417	2018/0179780 A1 *	6/2018	Dershem	E04H 15/644
					2018/0282035 A1 *	10/2018	Chen	B65D 63/1018

* cited by examiner

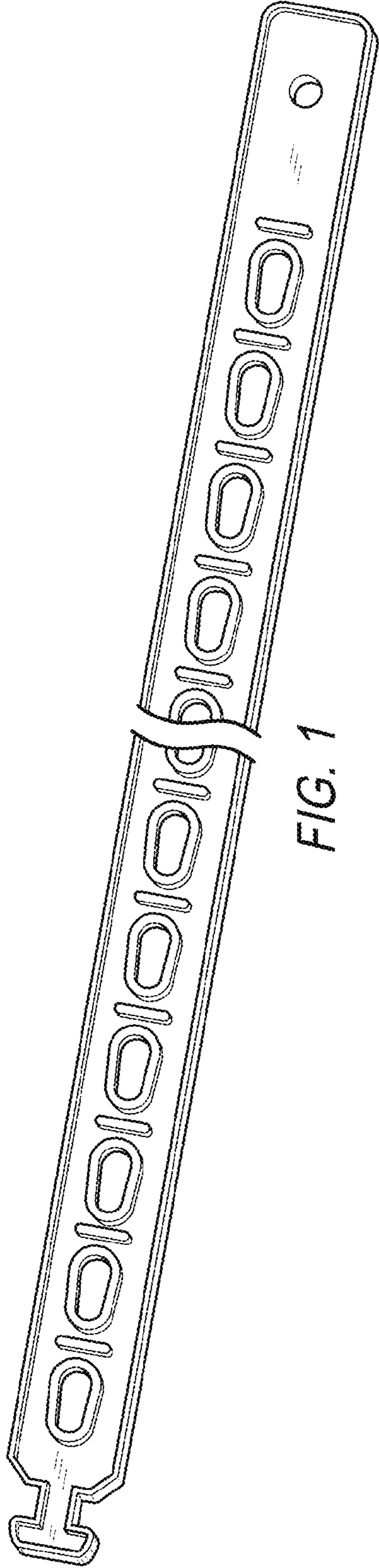

FIG. 1

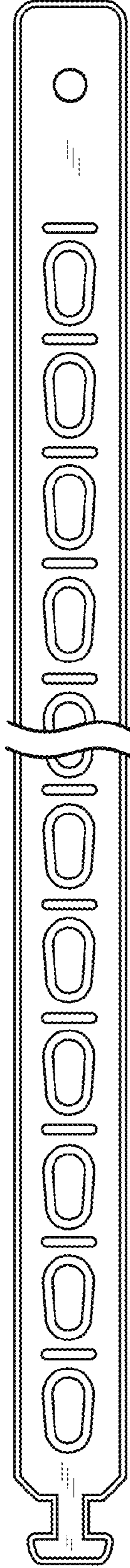

FIG. 2

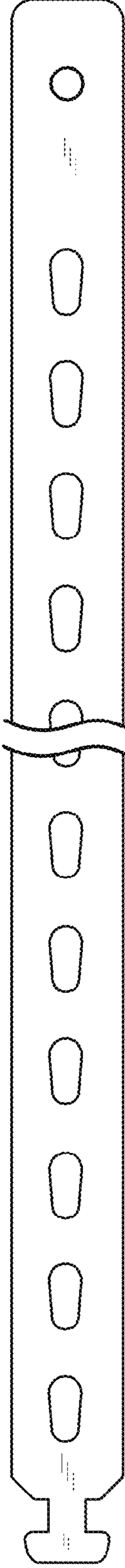

FIG. 3

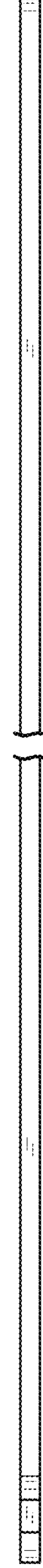

FIG. 4

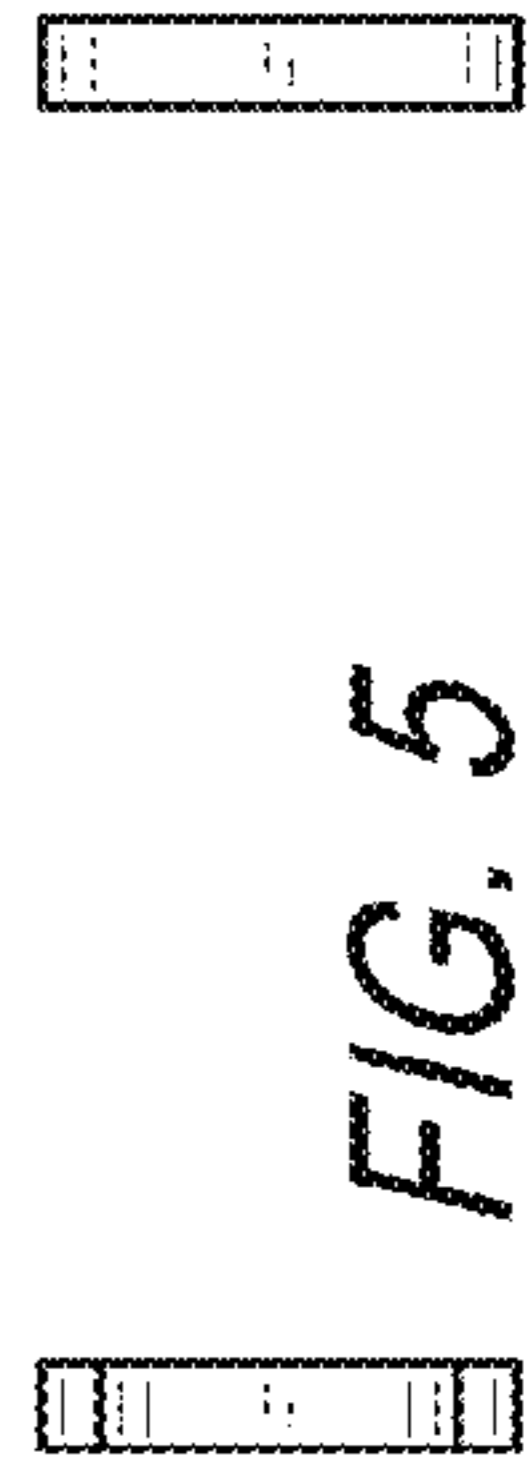

FIG. 5

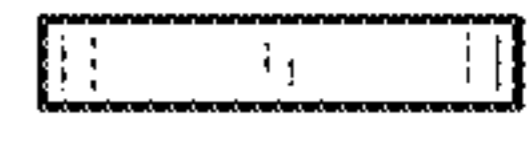

FIG. 6

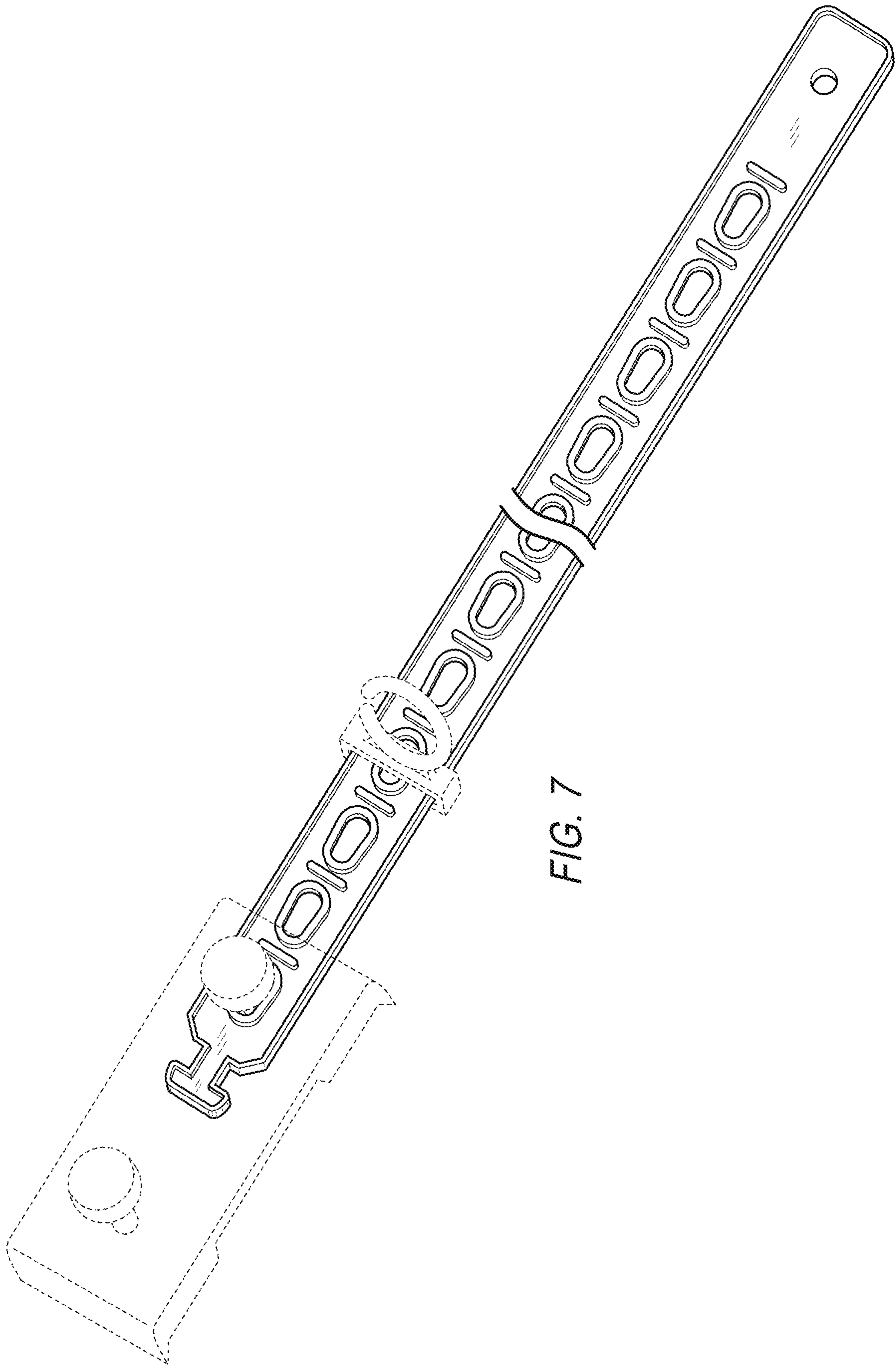

FIG. 7

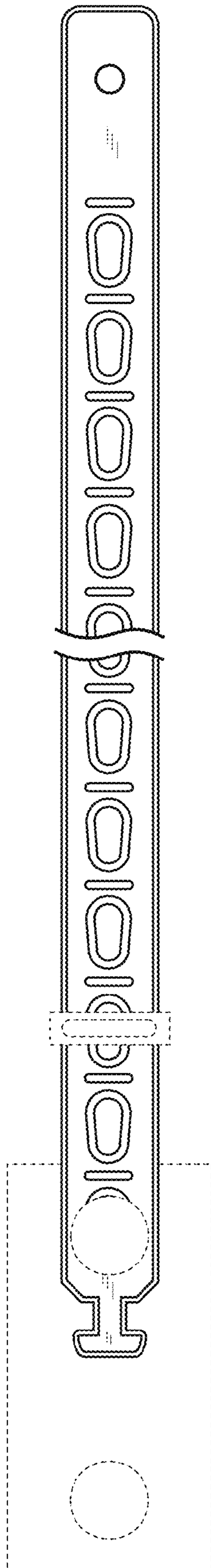

FIG. 8

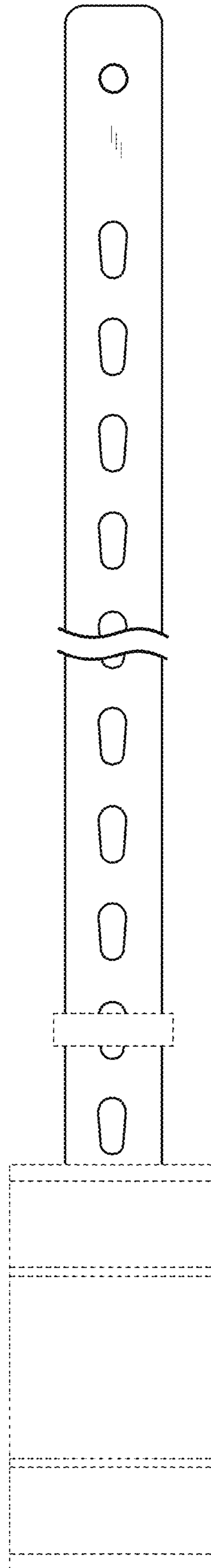

FIG. 9

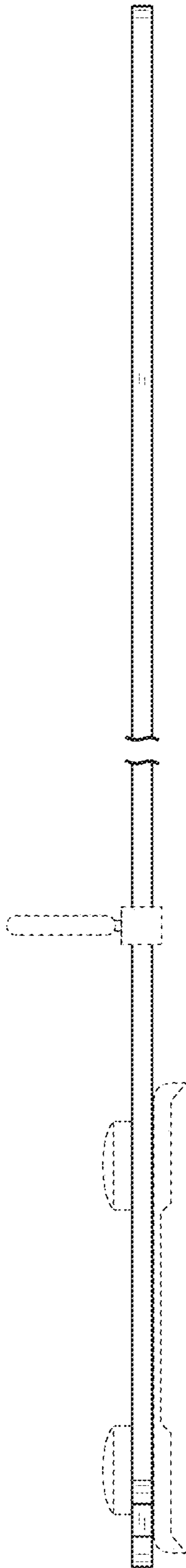

FIG. 10

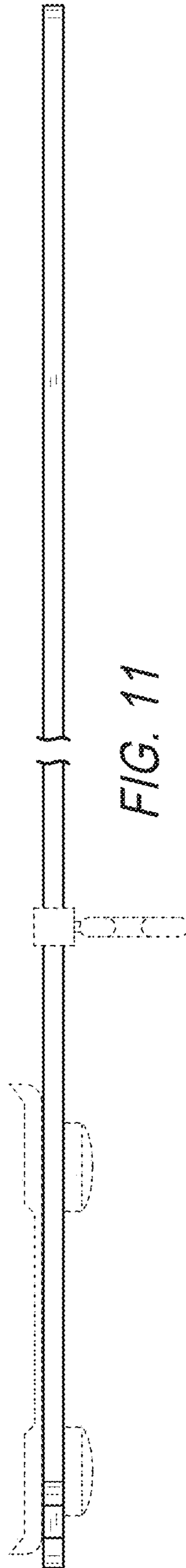

FIG. 11

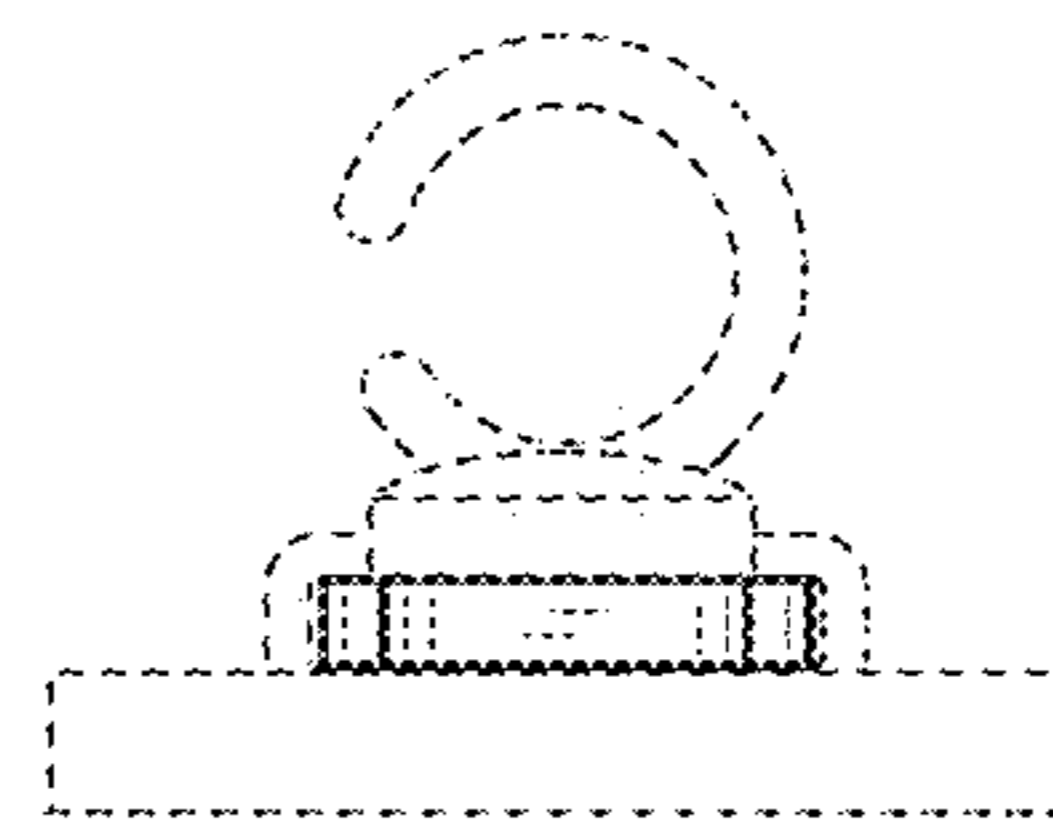

FIG. 12

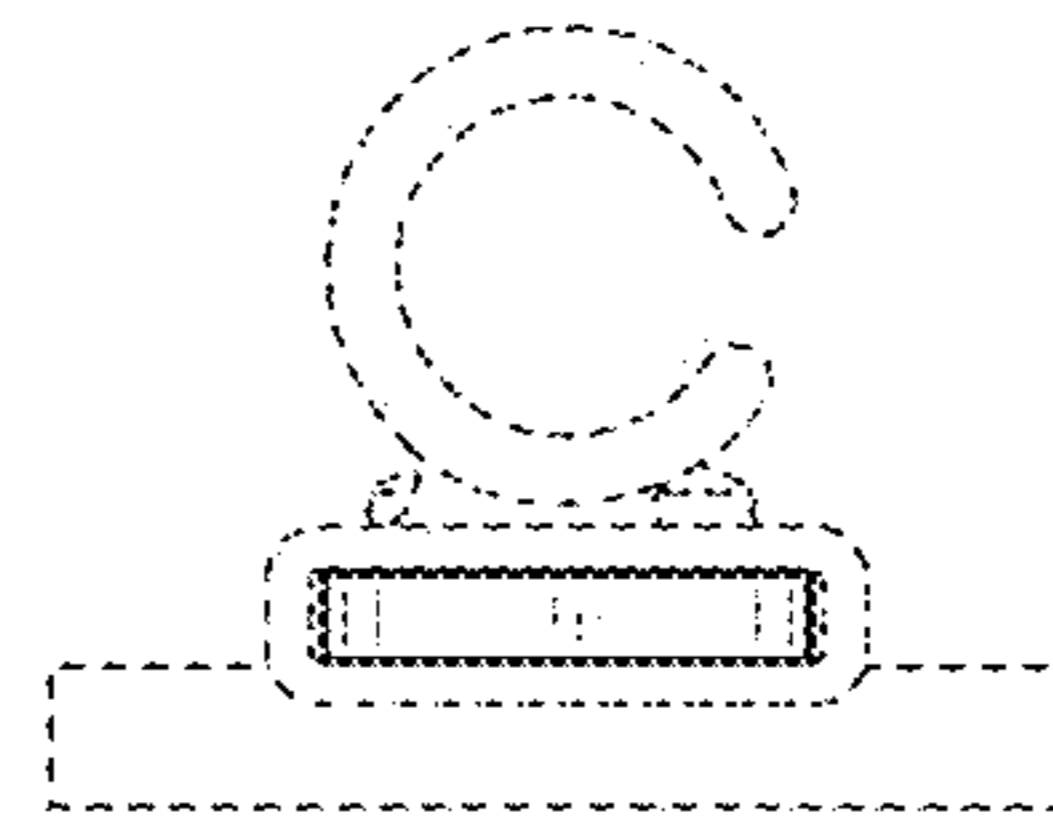

FIG. 13

UNITED STATES PATENT AND TRADEMARK OFFICE
CERTIFICATE OF CORRECTION

PATENT NO. : D894,722 S
APPLICATION NO. : 29/601051
DATED : September 1, 2020
INVENTOR(S) : Stacey et al.

Page 1 of 1

It is certified that error appears in the above-identified patent and that said Letters Patent is hereby corrected as shown below:

On the Title Page

At Column 2, in the Description, FIG. 4, please remove "a strap of".

Signed and Sealed this
Eighth Day of December, 2020

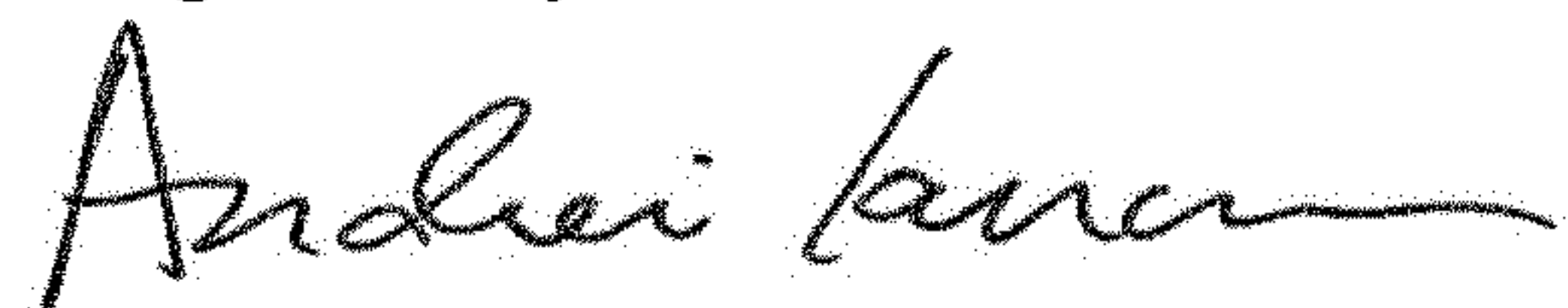

Andrei Iancu
Director of the United States Patent and Trademark Office