



US00D894705S

(12) **United States Design Patent**
Lundbaeck

(10) **Patent No.:** **US D894,705 S**

(45) **Date of Patent:** **** Sep. 1, 2020**

(54) **ROTARY POWER TOOL**

(71) Applicant: **Robert Bosch GmbH**, Stuttgart (DE)

(72) Inventor: **Andreas Lundbaeck**, Stockholm (SE)

(73) Assignee: **Robert Bosch GmbH**, Stuttgart (DE)

(**) Term: **15 Years**

(21) Appl. No.: **29/680,026**

(22) Filed: **Feb. 12, 2019**

(30) **Foreign Application Priority Data**

Aug. 16, 2018 (EM) 005610474

(51) **LOC (12) Cl.** **08-05**

(52) **U.S. Cl.**
USPC **D8/69**

(58) **Field of Classification Search**
USPC D8/14.1, 61-70
CPC B25D 16/00; B25D 17/02; B25D 11/125
See application file for complete search history.

(56) **References Cited**

U.S. PATENT DOCUMENTS

D524,626 S *	7/2006	Stirm	D8/69
D527,601 S *	9/2006	Stirm	D8/69
D535,537 S *	1/2007	Aglassinger	D8/69
D540,642 S *	4/2007	Stirm	D8/69
D543,082 S *	5/2007	Stirm	D8/69
D575,606 S *	8/2008	Okouchi	D8/69
D581,235 S *	11/2008	Aglassinger	D8/69
D663,183 S *	7/2012	Sell	D8/69

D676,731 S *	2/2013	Aglassinger	D8/69
D691,011 S *	10/2013	Walz	D8/68
D695,086 S *	12/2013	Walz	D8/68
D740,636 S *	10/2015	Koeniger	D8/69
2014/0318821 A1 *	10/2014	Wylter	B25D 11/125 173/104

* cited by examiner

Primary Examiner — Darlington Ly

(74) *Attorney, Agent, or Firm* — Magino, Moore & Beck LLP

(57) **CLAIM**

The ornamental design for a rotary power tool, as shown and described.

DESCRIPTION

FIG. 1 is a perspective view of a rotary power tool showing my new design;
 FIG. 2 is a left side elevational view of the rotary power tool of FIG. 1;
 FIG. 3 is a right side elevational view of the rotary power tool of FIG. 1;
 FIG. 4 is a front elevational view of the rotary power tool of FIG. 1;
 FIG. 5 is a rear elevational view of the rotary power tool of FIG. 1;
 FIG. 6 is a top plan view of the rotary power tool of FIG. 1;
 and,
 FIG. 7 is a bottom plan view of the rotary power tool of FIG. 1.

The broken lines shown in the drawings illustrate portions of the rotary power tool that form no part of the claimed design.

1 Claim, 7 Drawing Sheets

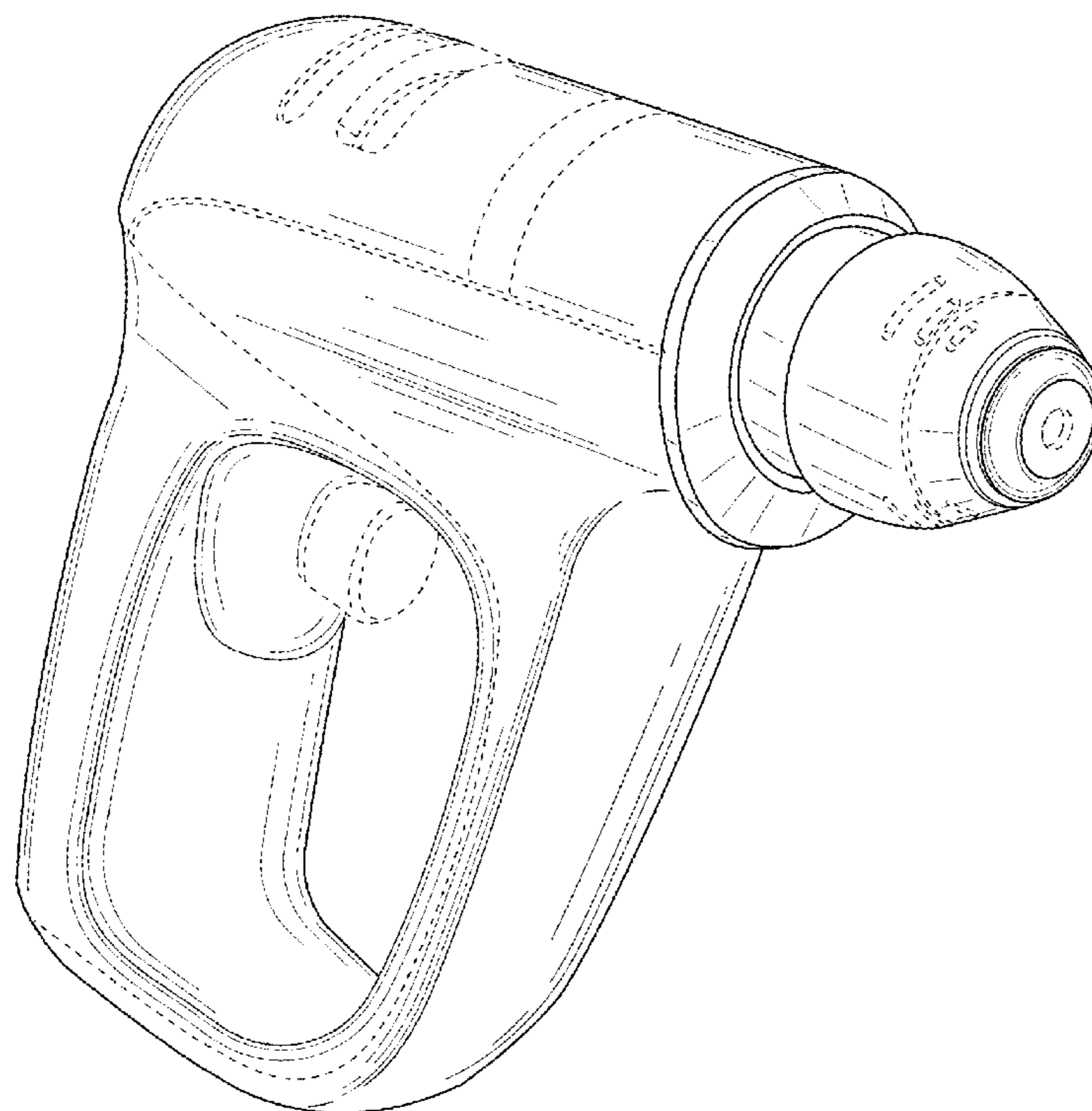

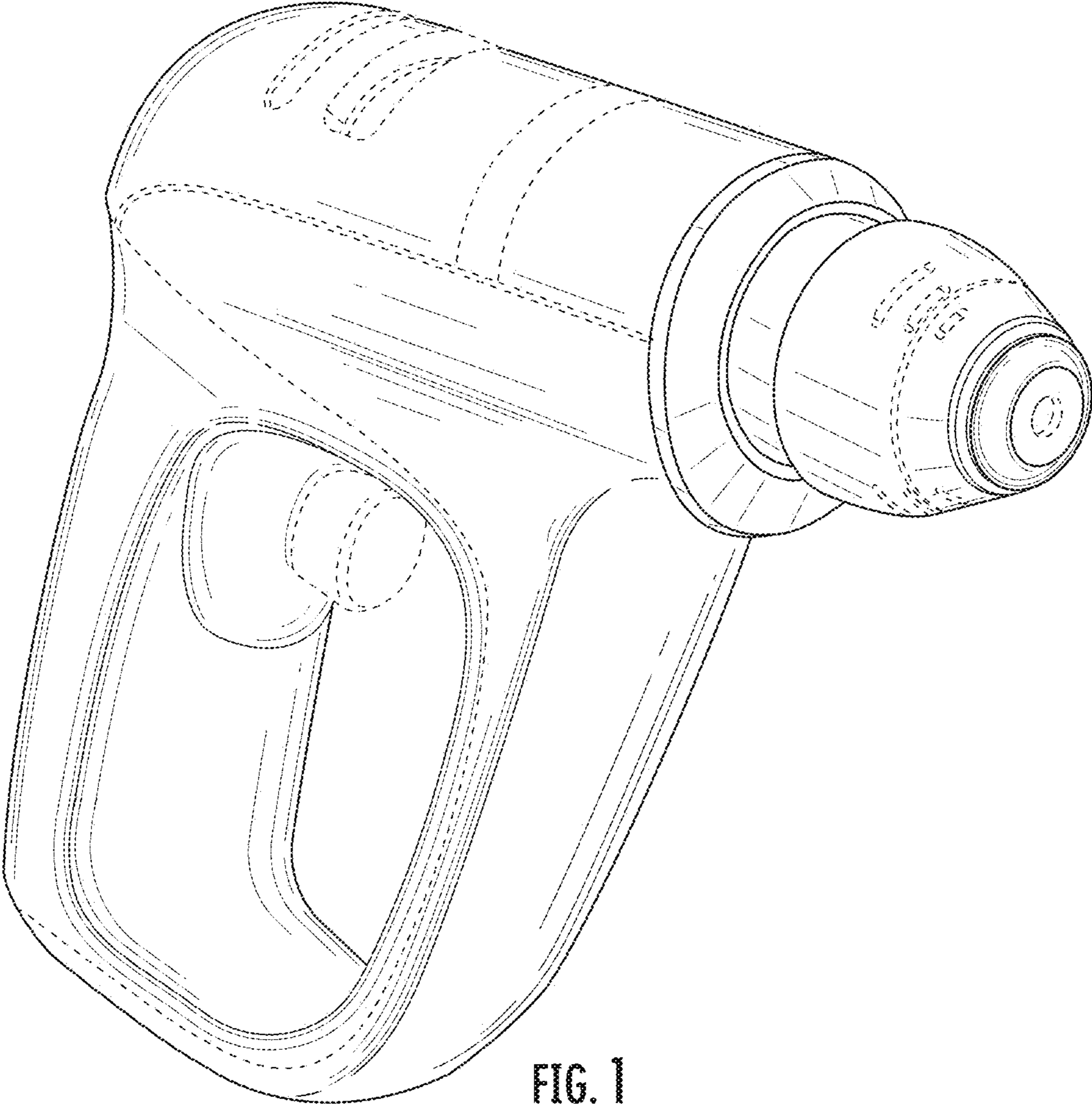

FIG. 1

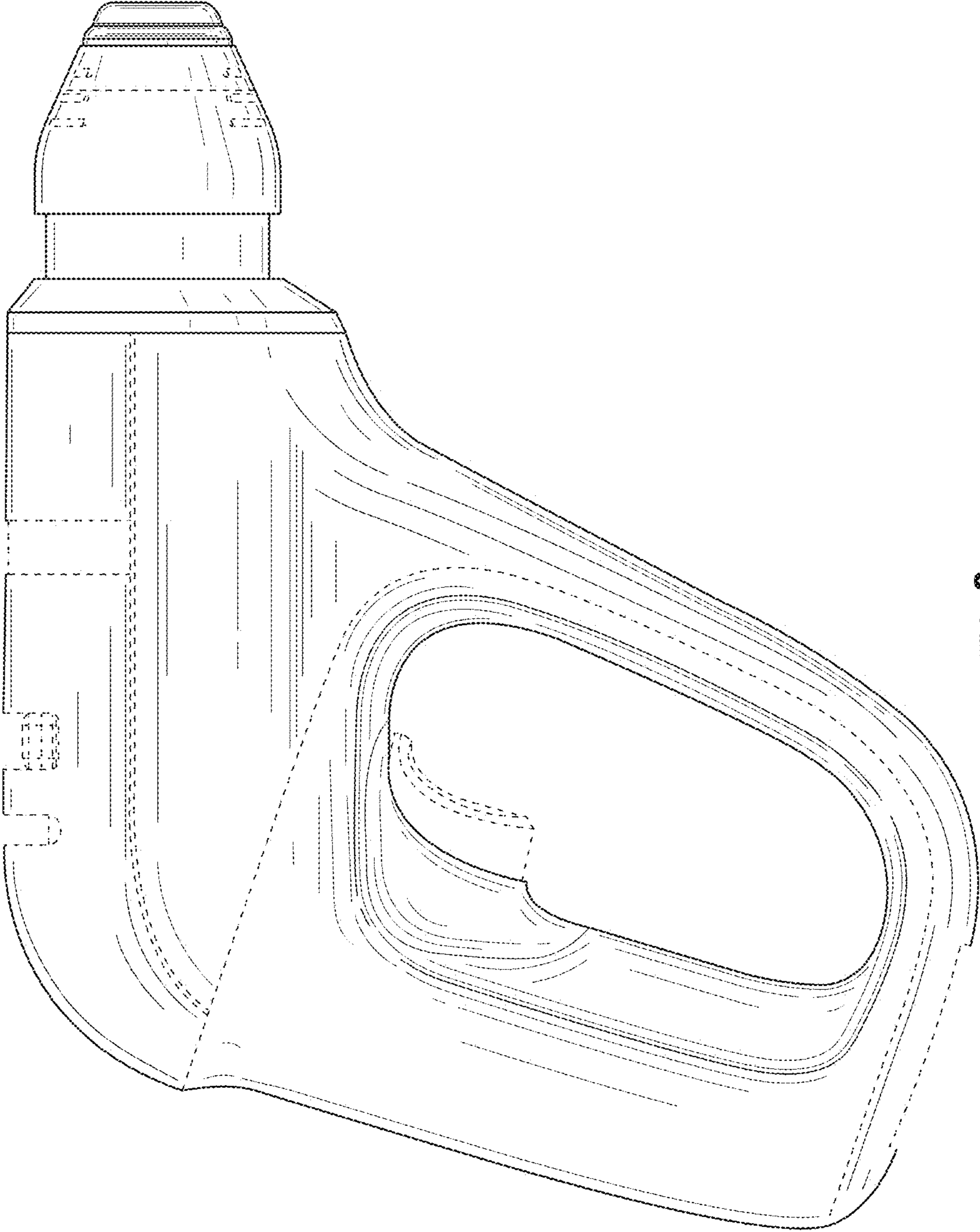

FIG. 2

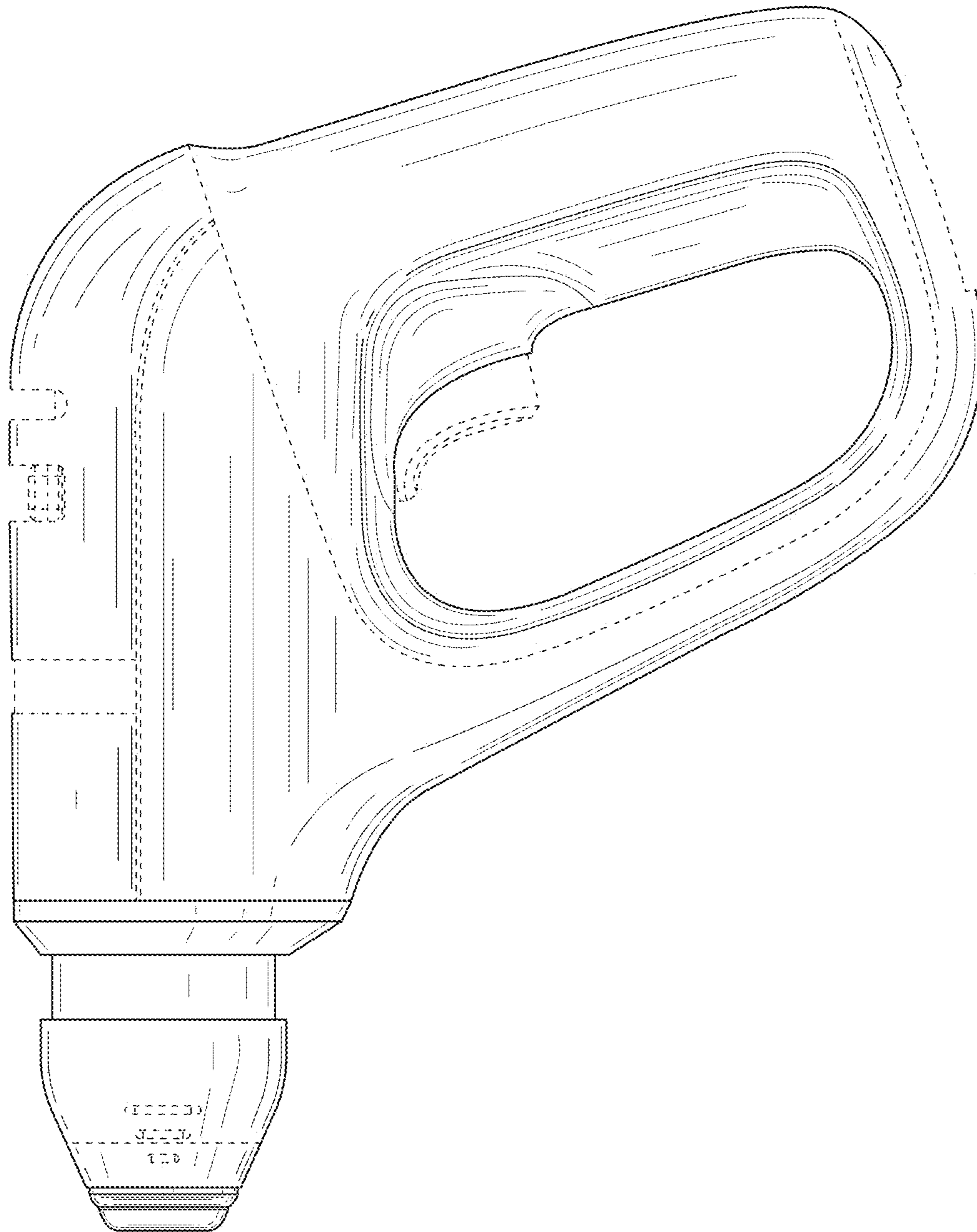

FIG. 3

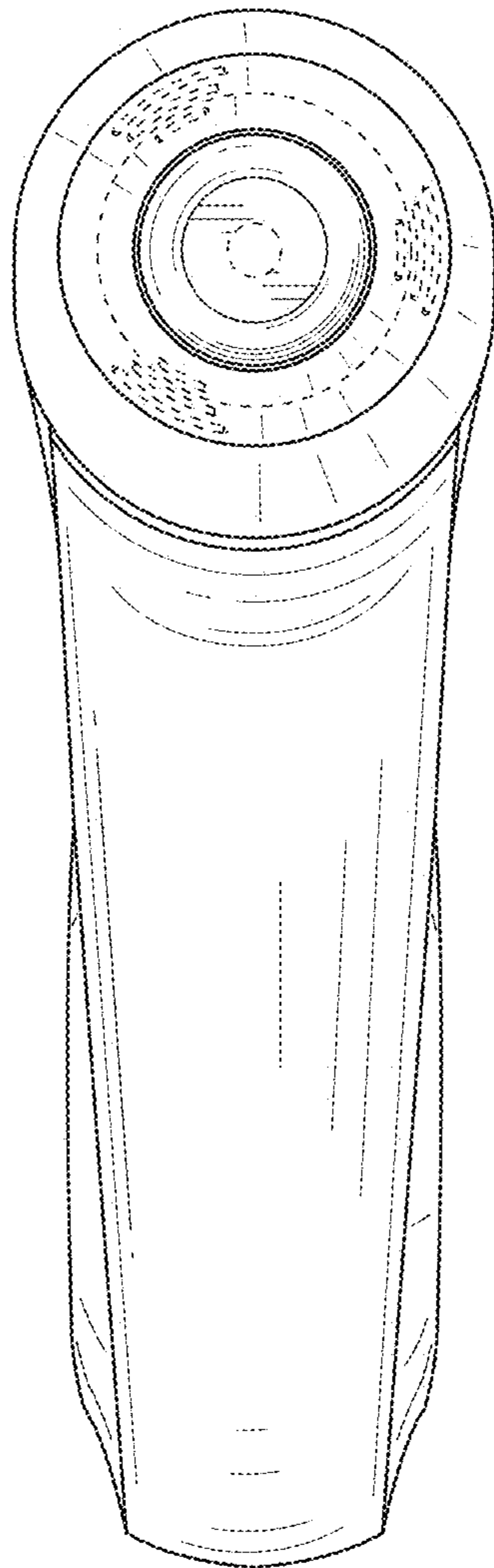

FIG. 4

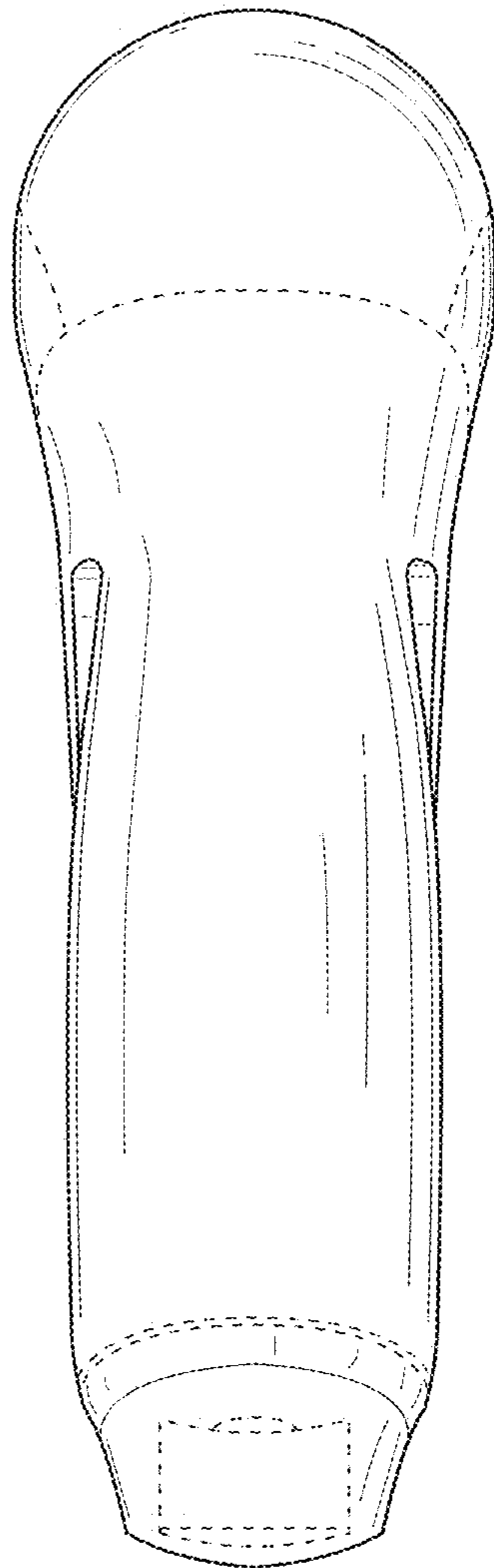

FIG. 5

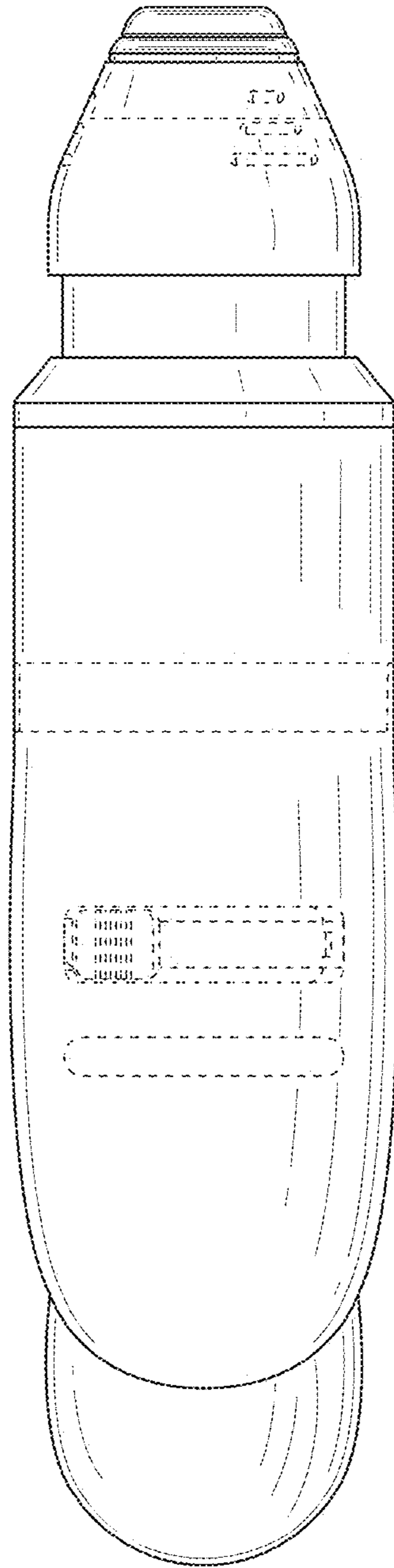

FIG. 6

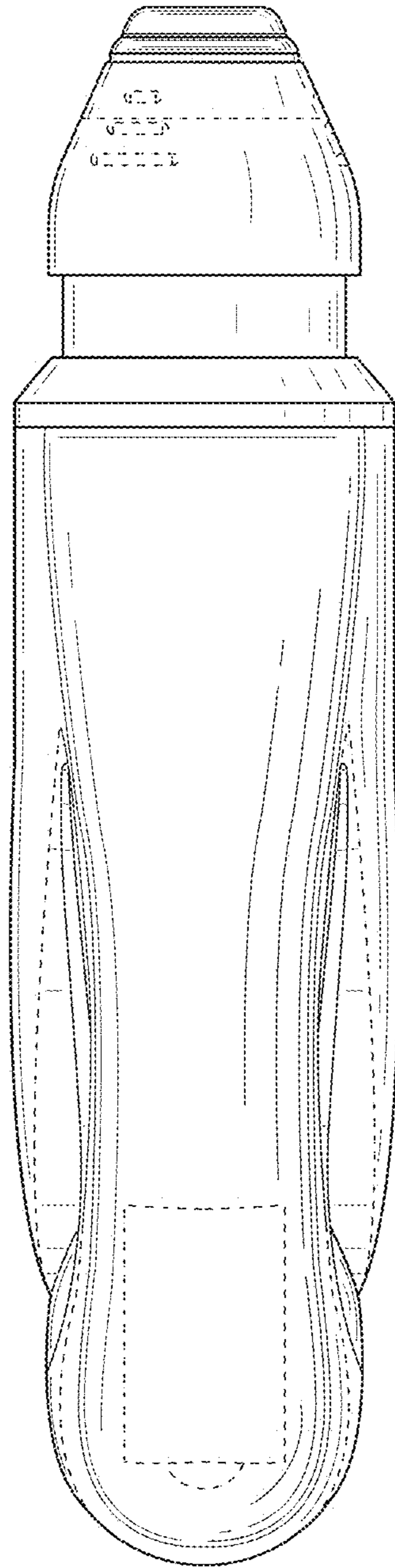

FIG. 7