



US00D894641S

(12) **United States Design Patent** (10) **Patent No.:** **US D894,641 S**  
**Davis et al.** (45) **Date of Patent:** **\*\* Sep. 1, 2020**

(54) **STAND**  
(71) Applicant: **WALKER EDISON FURNITURE COMPANY LLC**, Salt Lake City, UT (US)

D68,659 S 11/1925 Smith  
D78,127 S 3/1929 Schleicher  
D103,250 S 2/1937 Parrish  
2,207,307 A 7/1940 Teller  
(Continued)

(72) Inventors: **Matthew Davis**, Murray, UT (US);  
**Brad Bonham**, Draper, UT (US);  
**Richard A. Packer**, Kaysville, UT (US)

**FOREIGN PATENT DOCUMENTS**

CN 304163895 9/2017  
CN 305138614 5/2019  
(Continued)

(73) Assignee: **Walker Edison Furniture Company LLC**, Salt Lake City, UT (US)

**OTHER PUBLICATIONS**

“Walker Edison—W58BMHPAS Assembly Instructions.” Found online Jun. 19, 2020 at [www.walker-edison.com](http://www.walker-edison.com). Page dated Apr. 23, 2018. Retrieved from URL: [https://www.walker-edison.com/uploads/5/8/2/2/58227457/ai-w58bmhpas-%C2%AE\\_version\\_042318-e.pdf](https://www.walker-edison.com/uploads/5/8/2/2/58227457/ai-w58bmhpas-%C2%AE_version_042318-e.pdf) (Year: 2018).\*

(Continued)

(\*\*) Term: **15 Years**

*Primary Examiner* — Michael C Stout  
*Assistant Examiner* — Katelin G Kloberg  
(74) *Attorney, Agent, or Firm* — Workman Nydegger

(21) Appl. No.: **29/677,722**

(22) Filed: **Jan. 23, 2019**

(51) **LOC (12) Cl.** ..... **06-04**

(52) **U.S. Cl.**  
USPC ..... **D6/657**

(58) **Field of Classification Search**  
USPC ..... D6/657, 660, 661, 662.1, 669, 671, D6/671.1, 675  
CPC A47B 1/06; A47B 96/02; A47B 63/00; A47F 5/00

(57) **CLAIM**

The ornamental design for a stand, as shown and described.

**DESCRIPTION**

FIG. 1 is a front perspective view of a stand showing the new design;  
FIG. 2 is a front elevation view thereof;  
FIG. 3 is a back elevation view thereof;  
FIG. 4 is a top plan view thereof;  
FIG. 5 is a bottom plan view thereof;  
FIG. 6 is a right elevation view thereof; and,  
FIG. 7 is a left elevation view thereof.  
The broken lines in the drawings are for the purpose of illustrating portions of the article that form no part of the claimed design.

(56) **References Cited**

**U.S. PATENT DOCUMENTS**

245,925 A 8/1881 Kinsley  
309,799 A 12/1884 Poulson  
D47,600 S 7/1915 Koch  
D61,344 S 8/1922 Mayer  
1,475,088 A 11/1923 Specht et al.  
D64,390 S 4/1924 Arons  
D64,922 S 6/1924 Naill  
D66,028 S 11/1924 Lyons et al.  
D66,889 S 3/1925 Schleicher  
D68,065 S 8/1925 Schleicher

**1 Claim, 4 Drawing Sheets**

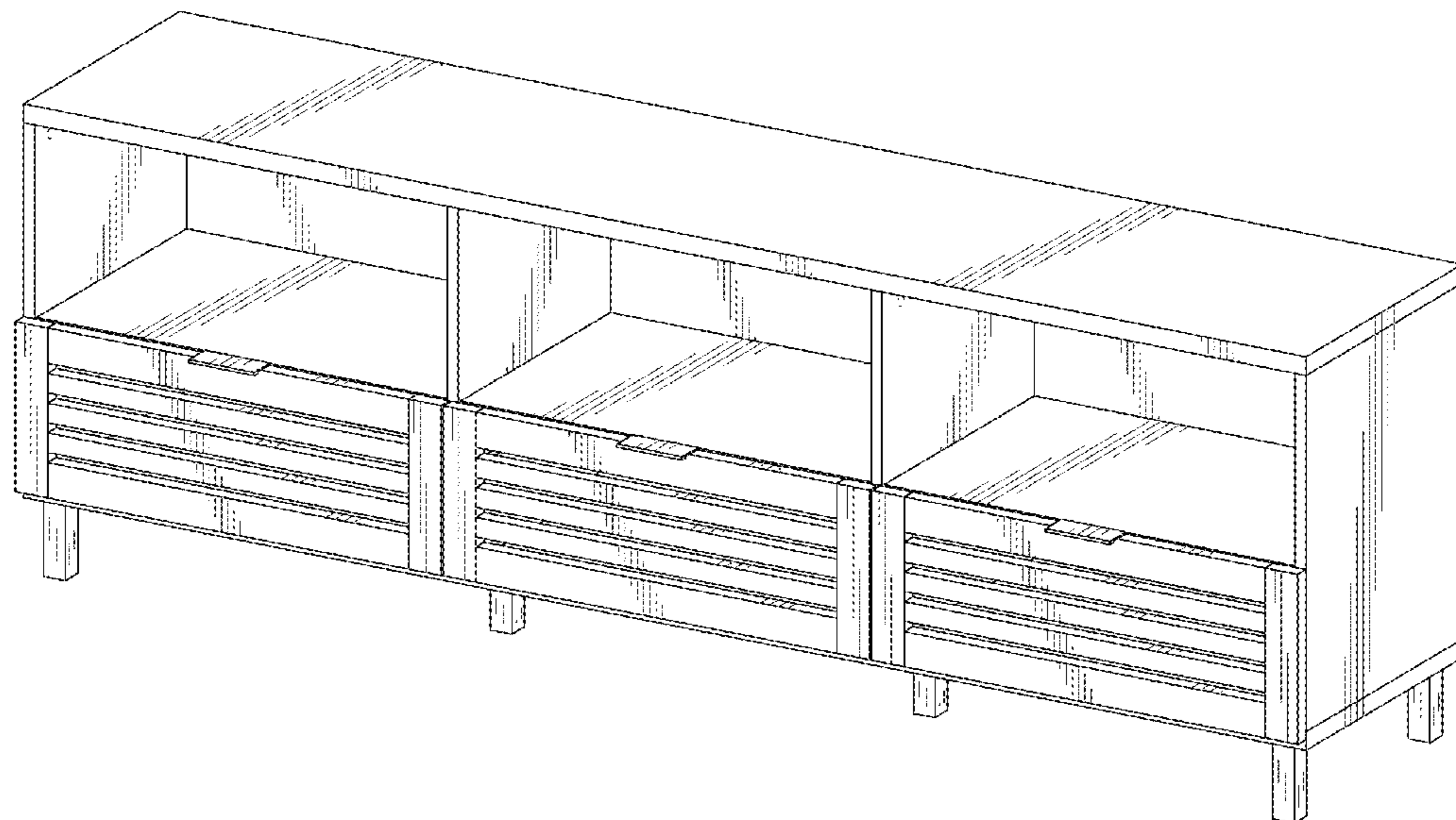

(56)

References Cited

U.S. PATENT DOCUMENTS

D166,077 S	3/1952	Haas	D423,813 S	5/2000	Paus
2,696,419 A	12/1954	Wallance	D425,330 S	5/2000	O'Hare
D175,869 S	10/1955	Trout	6,074,029 A	6/2000	Snoke
2,743,720 A	5/1956	Dollinger	D428,609 S	7/2000	Williams
D182,836 S	5/1958	Lubberts	D430,431 S	9/2000	Walter
2,850,346 A	9/1958	Holderle	D448,203 S	9/2001	Jeup
D186,115 S	9/1959	Church	D452,624 S	1/2002	de Blois
2,918,176 A	12/1959	Bell	D454,264 S	3/2002	Patik
D188,196 S	6/1960	Lubberts	D455,916 S	4/2002	Fluhrer
D188,197 S	6/1960	Swarts	6,393,207 B1	5/2002	Martin
3,039,621 A	6/1962	Pilcher	D466,333 S	12/2002	Hwang
D193,516 S	9/1962	Deaton	6,515,262 B1	2/2003	Li
D196,451 S	10/1963	McMullen	D477,160 S	7/2003	Grosfillex
3,217,671 A	11/1965	Walsh	D478,432 S	8/2003	Juneau
3,272,582 A	9/1966	Mack	D479,925 S	9/2003	Hsieh
3,354,878 A	11/1967	Balls	D485,709 S	1/2004	de Blois
3,589,746 A	6/1971	Inglis	D492,989 S	7/2004	Beck
RE27,186 E	10/1971	Ferdinand	D495,898 S	9/2004	Walker
RE27,200 E	10/1971	Ferdinand et al.	6,789,859 B1	9/2004	Ho
3,762,789 A	10/1973	Robertson	D497,741 S	11/2004	Sexton
3,766,863 A	10/1973	Swick	D499,274 S	12/2004	Juneau
D233,294 S	10/1974	Goulder	D499,281 S	12/2004	Yamaguchi
D236,676 S	9/1975	Urti	D499,583 S	12/2004	Anderson
D238,277 S	12/1975	Parker	D503,570 S	4/2005	Anderson
D239,352 S	3/1976	Petrick	D507,428 S	7/2005	Weatherly
D244,112 S	4/1977	Friedman	D510,211 S	10/2005	Welborn, Jr.
D248,429 S	9/1978	Robinson	D519,203 S	4/2006	Haas
D249,429 S	9/1978	Robinson	D519,299 S *	4/2006	Boudreau ..... D6/657
D249,860 S	10/1978	Ungaro	D522,771 S	6/2006	Berry
4,182,244 A	1/1980	Hutchins	D522,773 S *	6/2006	Becker ..... D6/661
D262,847 S	2/1982	Keller	D528,327 S	9/2006	O'Reilly
D269,754 S	7/1983	Kates	D534,379 S	1/2007	Juneau
D270,858 S	10/1983	McInnes	D534,998 S	1/2007	Charnick
D281,901 S	12/1985	Demrick	D536,770 S	2/2007	Mayer
D283,343 S	4/1986	Haythornthwaite	D538,406 S	3/2007	Mayer
D303,596 S	9/1989	Goetz	D539,057 S	3/2007	Senda
D304,982 S	12/1989	Bush	D542,059 S *	5/2007	Moyle ..... D6/678.1
D305,930 S	2/1990	MacAleese	D543,057 S	5/2007	Grady
D306,106 S	2/1990	Bush	D543,728 S	6/2007	Becker
D319,230 S	8/1991	Sugiyama	D548,488 S	8/2007	Weatherly
5,036,778 A	8/1991	Briosi	D548,490 S	8/2007	Becker
D319,743 S	9/1991	Grey	D549,991 S	9/2007	Stravitz
D327,735 S	7/1992	Smith	D554,393 S	11/2007	Yalif
D328,341 S	7/1992	Chiu	D555,397 S	11/2007	Yalif
D329,693 S	9/1992	Mills	D559,583 S	1/2008	Zambelli
D336,184 S	6/1993	Borgen	D559,584 S	1/2008	Zambelli
D347,754 S	6/1994	Mehlin	D559,585 S	1/2008	Lara
D348,576 S	7/1994	Narramore	D560,077 S	1/2008	Zambelli
D348,726 S	7/1994	Wilson	D560,396 S	1/2008	Weatherly
D353,960 S	1/1995	Barfield	D560,930 S	2/2008	Woodward
5,409,122 A	4/1995	Lazarus	D561,317 S	2/2008	Ou
5,452,812 A	9/1995	Niequist	D562,597 S	2/2008	Weatherly
D363,176 S	10/1995	Berry	D564,789 S	3/2008	deCarolis
D363,841 S	11/1995	Nourse	D567,346 S	4/2008	Lin
D364,055 S	11/1995	Pakla	D587,483 S	3/2009	Zambelli
D364,064 S	11/1995	Lorenz	D587,484 S	3/2009	Domack
5,463,966 A	11/1995	Nilsson	D587,497 S	3/2009	Zambelli
D365,472 S	12/1995	Rehnberg	D588,831 S	3/2009	Mohundro
D366,110 S	1/1996	Darr	D589,280 S	3/2009	Zambelli
D367,383 S	2/1996	Hatrack-Smith	D591,533 S	5/2009	Karsson
D373,693 S	9/1996	Elhage	D592,432 S	5/2009	Sexton
5,628,256 A	5/1997	Lazarus	7,530,538 B2	5/2009	Whalen
D385,431 S	10/1997	Lee	D593,776 S	6/2009	Sexton
5,695,081 A	12/1997	Alkalay	D594,248 S	6/2009	Zambelli
D389,343 S	1/1998	Van Der Merwe	D604,546 S	11/2009	Alman
D390,936 S	2/1998	French	D605,874 S	12/2009	Zambelli
5,752,500 A	5/1998	Jamieson	D606,331 S *	12/2009	Wicha ..... D6/657
5,782,231 A	7/1998	Wade	D611,727 S	3/2010	Vail
5,833,084 A	11/1998	Chang	D614,888 S	5/2010	Sexton
D403,529 S	1/1999	De Blaay	D618,015 S	6/2010	Sexton
D404,937 S	2/1999	Tarlow	D618,016 S	6/2010	Metcalf
D407,577 S	4/1999	Dorst	D620,278 S *	7/2010	Zambelli ..... D6/661
D408,174 S	4/1999	Aspenwall	D620,283 S	7/2010	Calco
D420,114 S	2/2000	Johnson	D622,834 S	8/2010	Jiang
D423,810 S	5/2000	Dorst	D623,442 S	9/2010	Zambelli
			D623,876 S	9/2010	Zambelli
			D623,877 S	9/2010	Zambelli
			D625,123 S	9/2010	Zambelli
			D630,453 S	1/2011	Rafieha

(56)

References Cited

U.S. PATENT DOCUMENTS

D632,902 S 2/2011 Rafieha  
 D638,922 S 5/2011 Zhou  
 7,934,494 B1 5/2011 Schneider  
 D640,072 S 6/2011 Sexton  
 D641,861 S 7/2011 Okamoto  
 D644,853 S 9/2011 Becker  
 D653,051 S 1/2012 Lin  
 D653,739 S 2/2012 Gibbs  
 D654,289 S 2/2012 Zambelli  
 D654,995 S 2/2012 Asofsky  
 D654,996 S 2/2012 Asofsky  
 D655,946 S 3/2012 Sexton  
 D658,750 S 5/2012 Nemes  
 D663,137 S 7/2012 Andersen  
 D663,138 S 7/2012 Andersen  
 D665,897 S 8/2012 Martin  
 D666,281 S 8/2012 Nemes  
 D667,654 S 9/2012 Lenney  
 D668,475 S 10/2012 Zambelli  
 D669,704 S 10/2012 Zambelli  
 D669,706 S 10/2012 Zambelli  
 D669,707 S 10/2012 Zambelli  
 D670,105 S 11/2012 Jespersen  
 D674,891 S 1/2013 Huang  
 D675,716 S 2/2013 Schwartz  
 D687,250 S 8/2013 Weatherly  
 D694,873 S 12/2013 Nemes  
 D696,758 S 12/2013 Ernst  
 8,607,776 B2 12/2013 Jansson  
 8,813,656 B1 8/2014 Hazzard  
 D716,288 S 10/2014 O'Heron  
 D717,081 S 11/2014 Dworman  
 D717,569 S 11/2014 Davis  
 D718,956 S 12/2014 Helser  
 D718,957 S 12/2014 Heiser  
 D719,384 S 12/2014 Sowers  
 D720,563 S 1/2015 Burden  
 D723,148 S 2/2015 Lawrence  
 D723,843 S 3/2015 Lai  
 9,004,060 B2 4/2015 Benedetti  
 D731,823 S 6/2015 Kelinske  
 D736,012 S 8/2015 Davis  
 D737,418 S 8/2015 Hrydovyy  
 D738,477 S 9/2015 Nemes  
 D738,647 S 9/2015 Muller  
 D741,630 S 10/2015 Meissner  
 D742,142 S 11/2015 Everson  
 D742,662 S 11/2015 Muller  
 D743,192 S 11/2015 Davis  
 D746,614 S 1/2016 Sheppard  
 D747,123 S 1/2016 Zambelli  
 D747,788 S 1/2016 Baker  
 D747,900 S 1/2016 Sheppard  
 9,228,742 B2 1/2016 Akiyama  
 D748,768 S 2/2016 Stanton  
 D752,905 S 4/2016 Healy  
 D753,930 S 4/2016 Vengadakrishnan  
 D757,350 S 5/2016 Levy  
 D758,766 S 6/2016 Kirar  
 D759,997 S 6/2016 Ruiz  
 D767,752 S 6/2016 Davis  
 D767,753 S 9/2016 Edmund  
 D768,413 S 10/2016 Huang  
 D773,862 S 12/2016 Davis  
 D775,866 S 1/2017 Ben Avi  
 D777,479 S 1/2017 Anderson  
 D778,641 S 2/2017 Anderson  
 D778,646 S 2/2017 Davis  
 D783,324 S 4/2017 Akana  
 D791,302 S 7/2017 Davis  
 D791,522 S 7/2017 Rodd  
 D792,132 S 7/2017 Peota  
 D793,776 S 8/2017 Davis  
 D798,640 S 10/2017 Anderson  
 D804,861 S 12/2017 Failing

D807,671 S 1/2018 Caillouet  
 D808,203 S 1/2018 Davis  
 D808,688 S 1/2018 Everson  
 D808,690 S 1/2018 Hsu  
 D812,938 S 3/2018 Moore  
 D814,410 S 4/2018 Emslie  
 D817,037 S 5/2018 Davis  
 D817,038 S 5/2018 Davis  
 D817,040 S 5/2018 Davis  
 D817,666 S 5/2018 Davis  
 D817,667 S 5/2018 Davis  
 D818,750 S 5/2018 Hannoosh  
 D821,038 S 6/2018 Rathman  
 D824,703 S 8/2018 Yamamoto  
 D825,233 S 8/2018 Yamamoto  
 D825,959 S 8/2018 Rockwell  
 D833,782 S 11/2018 Amacher  
 D834,354 S 11/2018 Davis  
 D834,355 S 11/2018 Davis  
 D835,437 S 12/2018 Stukenberg  
 D835,925 S 12/2018 Denby  
 D838,523 S 1/2019 Yamamoto  
 D843,756 S 3/2019 Johnson  
 D845,041 S 4/2019 Davis  
 D845,679 S 4/2019 Li  
 D845,683 S 4/2019 Pedersen  
 D848,766 S 5/2019 Chen  
 D848,768 S 5/2019 Johnson  
 D848,770 S 5/2019 Davis  
 D849,457 S 5/2019 Kundig  
 D850,815 S 6/2019 Nicoll  
 D858,148 S 9/2019 Crutcher  
 D860,687 S 9/2019 Parikh  
 D869,202 S 12/2019 Davis  
 D878,816 S 3/2020 Davis  
 2004/0074858 A1 4/2004 Thuma  
 2004/0079714 A1 4/2004 Andrew  
 2004/0222721 A1 11/2004 Kelley  
 2004/0237853 A1 12/2004 Sholz  
 2005/0000241 A1 1/2005 Kucera  
 2005/0103734 A1 5/2005 Saltzberg  
 2007/0062983 A1 3/2007 Barnett  
 2007/0138119 A1 6/2007 Schwerdlin  
 2007/0236111 A1 10/2007 Gray  
 2008/0116771 A1 5/2008 Green  
 2008/0181587 A1 7/2008 Patil  
 2008/0203042 A1 8/2008 Felsenthal  
 2008/0216817 A1 9/2008 Yungbluth  
 2009/0025414 A1 1/2009 Koga  
 2009/0151375 A1 6/2009 Tarr  
 2009/0170421 A1 7/2009 Adrian  
 2009/0220221 A1 9/2009 Zhou  
 2010/0307179 A1 12/2010 Fava  
 2011/0000477 A1 1/2011 Kwon  
 2011/0017691 A1 1/2011 Wu  
 2011/0079688 A1 4/2011 Grove  
 2011/0080261 A1 4/2011 Asofsky  
 2011/0120166 A1 5/2011 Nadel  
 2011/0220090 A1 9/2011 Atemboski  
 2014/0116418 A1 5/2014 Thomas  
 2014/0252939 A1 9/2014 Tunzi  
 2014/0265754 A1 9/2014 Patterson  
 2014/0265807 A1 9/2014 Kendall  
 2014/0318529 A1 10/2014 Nielsen  
 2015/0182021 A1 7/2015 Chang  
 2015/0323190 A1 11/2015 Stein  
 2016/0018112 A1 1/2016 Phillips  
 2016/0100698 A1 4/2016 Clark  
 2016/0209102 A1 7/2016 Vulava  
 2016/0223213 A1 8/2016 Grohova  
 2016/0256032 A1 9/2016 Bhajak  
 2017/0089587 A1 3/2017 Nemes  
 2017/0211814 A1 7/2017 Bourne  
 2018/0064246 A1 3/2018 Kassanoff

FOREIGN PATENT DOCUMENTS

GB 1162368 8/1969  
 GB 4001474 5/2007

(56)

## References Cited

## FOREIGN PATENT DOCUMENTS

GB	4032905	11/2013
GB	4034171	7/2014
WO	WOD076242-061	5/2011

## OTHER PUBLICATIONS

“Mid Century Modern TV Stand.” Found online Jun. 20, 2020 at [www.amazon.com](http://www.amazon.com). Product first available Jun. 16, 2020. Retrieved from URL: <https://tinyurl.com/y7qolcv7> (Year: 2020).\*

“Pemberly Row Modern Mid Century Entertainment TV Stand.” Found online Jun. 20, 2020 at [www.amazon.com](http://www.amazon.com). Product first available May 25, 2018. Retrieved from URL: <https://tinyurl.com/y9affau7> (Year: 2018).\*

Pinterest; Cabinet Furniture; wood veneer sideboard with doors—Edge Collection by Miniforms; <https://www.pinterest.com/pin/312366924137895643/>; Retrieved on Aug. 9, 2018.

Edge Buffet and Cabinet; Miniforms.com; [https://www.miniforms.com/en/products/4\\_buffet-and-cabinet/105\\_edge/#f](https://www.miniforms.com/en/products/4_buffet-and-cabinet/105_edge/#f); Retrieved on Aug. 9, 2018.

Pinterest; Media Furniture Search; <https://www.pinterest.com/pin/33636328451628908/>; Retrieved on Apr. 16, 2018.

Pinterest; Furniture Search; <https://www.pinterest.com/pin/33636328453466237/>; Retrieved on Apr. 11, 2018.

U.S. Appl. No. 29/714,849, dated Apr. 6, 2020, Notice of Allowance.

U.S. Appl. No. 29/634,946, dated Apr. 8, 2020, Notice of Allowance.

U.S. Appl. No. 29/654,952, dated Apr. 21, 2020, Notice of Allowance.

U.S. Appl. No. 29/720,093, filed Jan. 9, 2020, Davis.

U.S. Appl. No. 29/714,849, filed Nov. 26, 2019, Davis.

U.S. Appl. No. 29/720,729, filed Jan. 15, 2020, Davis.

U.S. Appl. No. 29/720,732, filed Jan. 15, 2020, Davis.

U.S. Appl. No. 29/721,435, filed Jan. 21, 2020, Davis.

U.S. Appl. No. 29/720,734, filed Jan. 15, 2020, Davis.

U.S. Appl. No. 29/720,923, filed Jan. 16, 2020, Davis.

U.S. Appl. No. 29/720,927, filed Jan. 16, 2020, Davis.

U.S. Appl. No. 29/720,942, filed Jan. 16, 2020, Davis.

U.S. Appl. No. 29/720,948, filed Jan. 16, 2020, Davis.

U.S. Appl. No. 29/721,166, filed Jan. 17, 2020, Davis.

60" Tiered Top Console; <https://www.wayfair.com/furniture/pdp/real-flame-calie-tv-stand-for-tvs-up-to-48-inches-with-electric-fireplace-included-jfp1647.html>; Retrieved on Dec. 12, 2019.

58" Lincoln Console; <https://www.pinterest.com/pin/312366924137895643/>; Retrieved on Aug. 9, 2018.

58" Lincoln Console; [https://www.miniforms.com/en/products/4\\_buffet-and-cabinet/105\\_edge/#f](https://www.miniforms.com/en/products/4_buffet-and-cabinet/105_edge/#f); Retrieved on Aug. 9, 2018.

60" Jacklyn TV Console; <https://www.pinterest.com/pin/33636328451628908/>; Retrieved on Apr. 16, 2018.

60" Victor TV Console; <https://www.pinterest.com/pin/33636328453466237/>; Retrieved on Apr. 11, 2018.

70" Tiered Top Open Shelf Fireplace; <https://www.wayfair.com/furniture/pdp/real-flame-calie-tv-stand-for-tvs-up-to-48-inches-with-electric-fireplace-included-jfp1647.html>; Retrieved on Jan. 10, 2018.

48" Radcliff Buffet; <https://www.walker-edison.com/buffet-52-console-table.html>; Retrieved on Jul. 19, 2018.

U.S. Appl. No. 29/654,952, dated Feb. 12, 2020, Notice of Allowance.

U.S. Appl. No. 29/698,919, dated Jul. 22, 2019, Davis.

U.S. Appl. No. 29/698,928, dated Jul. 22, 2019, Davis.

U.S. Appl. No. 29/698,940, dated Jul. 22, 2019, Davis.

U.S. Appl. No. 29/699,063, dated Jul. 23, 2019, Davis.

U.S. Appl. No. 29/699,066, dated Jul. 23, 2019, Davis.

U.S. Appl. No. 29/699,071, dated Jul. 23, 2019, Davis.

U.S. Appl. No. 29/699,073, dated Jul. 23, 2019, Davis.

U.S. Appl. No. 29/699,078, dated Jul. 23, 2019, Davis.

U.S. Appl. No. 29/698,942, dated Jul. 22, 2019, Davis.

U.S. Appl. No. 29/698,947, dated Jul. 22, 2019, Davis.

42 in. Metal and Wood Desk with Glass and Shelf Grey Wash by Walker Edison Furniture Company—Home Depot <https://www.homedepot.com/p/com/p/Walker-Edison-Furniture-Company-42-in-Metal-and-Wood-Desk-with-Glass-and-Shelf-Grey-Wash-HDM42JERGW/305309102> retrieved from the internet on Sep. 9, 2019.

Dark Walnut Wood and Glass Coffee Table by Walker Edison Furniture Company—Home Depot <https://www.homedepot.com/Walker-Edison-Furniture-Company-Dark-Walnut-Wood-and-Glass-Coffee-Table-HDF42JMGLDW/305308482> retrieved from the internet on Nov. 6, 2019.

“Baum TV Stand for TVs up to 58 inches” Wayfair. (Accessed Nov. 14, 2019).

“Dark Walnut 70" TV Stand” Pierl. (Accessed Nov. 14, 2019).

“Seren TV Stand for TVs up to 50 inches” Wayfair. (Accessed Nov. 14, 2019).

“Shreffler TV Stand for TVs up to 78 inches” Wayfair. (Accessed Nov. 14, 2019).

Electric Fireplaces Direct.com. <https://www.electricfireplacesdirect.com/products-accessories/tv-media-consoles/shelby-electric-fireplace-media-console-in-white-c3p18c9-2030w.html>. “Shelby Electric Fireplace Media Console in White”. Date unknown: Viewed Dec. 2019 (Year: 2019).

Pikove. <https://pikove.com/media/509962357792326443>. “Home Decor”. Feb. 2017 (Year: 2017).

Luno. <https://iamluno.com/product/kc27-record-console-new/>. “KC27 HIFI Record Console”. Date unknown: Viewed Dec. 2019 (Year: 2019).

U.S. Appl. No. 29/654,952, dated Nov. 15, 2019, Office Action.

U.S. Appl. No. 29/656,492, dated Nov. 18, 2019, Notice of Allowance.

U.S. Appl. No. 29/634,946, dated Dec. 12, 2019, Office Action.

U.S. Appl. No. 29/656,485, dated Dec. 18, 2019, Notice of Allowance.

U.S. Appl. No. 29/654,950, dated Dec. 27, 2019, Notice of Allowance.

U.S. Appl. No. 29/656,499, dated Jan. 23, 2020, Notice of Allowance.

U.S. Appl. No. 29/656,497, dated Jan. 23, 2020, Notice of Allowance.

U.S. Appl. No. 29/656,489, dated Jan. 24, 2020, Notice of Allowance.

U.S. Appl. No. 29/714,849, dated Feb. 25, 2020, Restriction Requirement.

U.S. Appl. No. 29/611,962, dated Jul. 27, 2017, Davis.

U.S. Appl. No. 29/611,963, dated Jul. 27, 2017, Davis.

U.S. Appl. No. 29/634,946, dated Jan. 25, 2018, Davis.

U.S. Appl. No. 29/634,903, dated Jan. 25, 2018, Davis.

U.S. Appl. No. 29/654,941, dated Jun. 28, 2018, Davis.

U.S. Appl. No. 29/654,935, dated Jun. 28, 2018, Davis.

U.S. Appl. No. 29/654,950, dated Jun. 28, 2018, Davis.

U.S. Appl. No. 29/656,499, dated Jul. 12, 2018, Davis.

U.S. Appl. No. 29/656,479, dated Jul. 12, 2018, Davis.

U.S. Appl. No. 29/656,485, dated Jul. 12, 2018, Davis.

U.S. Appl. No. 29/656,486, dated Jul. 12, 2018, Davis.

U.S. Appl. No. 29/656,497, dated Jul. 12, 2018, Davis.

U.S. Appl. No. 29/654,930, dated Jun. 28, 2018, Davis.

U.S. Appl. No. 29/654,936, dated Jun. 28, 2018, Davis.

U.S. Appl. No. 29/654,952, dated Jun. 28, 2018, Davis.

U.S. Appl. No. 29/656,492, dated Jul. 12, 2018, Davis.

U.S. Appl. No. 29/656,489, dated Jul. 12, 2018, Davis.

U.S. Appl. No. 29/634,889, dated Jan. 25, 2018, Davis.

U.S. Appl. No. 29/677,723, dated Jan. 23, 2019, Davis.

U.S. Appl. No. 29/677,724, dated Jan. 23, 2019, Davis.

U.S. Appl. No. 29/677,738, dated Jan. 23, 2019, Davis.

U.S. Appl. No. 29/677,755, dated Jan. 23, 2019, Davis.

U.S. Appl. No. 29/677,761, dated Jan. 23, 2019, Davis.

Electric fireplace, image post date May 26, 2014, site visited Aug. 8, 2016, (online), <<https://www.tineye.com/search/3c3d0cbfb7030b3079ebefa0774a5b4e94120332/?pluginver>

Media Console with Electric Fireplace, image post date Dec 6, 2015, site visited Aug. 8, 2016, (online), <<http://www.overstock.com/Home-Garden/Media-Console-with-Electric-Fireplace-in->

(56)

## References Cited

## OTHER PUBLICATIONS

Barnwood/10309735/product.html?reset=05953330-aaa1-4640-a796-f225c2f8176d&refccid=MRISGBB2MZGZXYKK4EFV125H6Q&recalg=809,828,512&recidx=1#reviews.

TV Stand With Fireplace, image post date Sep. 12, 2015, site visited Aug. 8, 2016, (online), <<https://www.tineye.com/search/77be8934bf07249cbb245c8ea0f719199437b185/>>.

Walker Edison TV Stand with Fireplace Insert, image post date Jul. 31, 2015, site visited Aug. 8, 2016, (online), <<https://www.amazon.com/Walker-Edison-Fireplace-Insert-Espresso/dp/BOOPNONTAK>>.

Manchester Fireplace TV Console, image post date Dec. 17, 2015, site visited Aug. 8, 2016, (online), <<http://www.walmart.com/ip/Manchester-Media-Fireplace-Stand-for-TVs-up-to-70/46360223>>.

Monet Fireplace; Canadian Tire Company website: <http://www.canadiantire.ca/en/pdp/monet-fireplace-0643572p.html>; retrieved on Dec. 21, 2016.

TV and Media Consoles, image post date Sep. 21, 2013, site visited Oct. 26, 2016, (online), <<http://web.archive.org/web/20130921074219/http://www.electrificreplacesdirect.com/Gallery/tv-and-media-consoles.html>>.\*

“Kendall Electric Media Fireplace—Espresso” Dec. 24, 2012, amazon.com, site visited Mar. 6, 2018 <[https://www.amazon.com/Kendall-Electric-Media-Fireplace-Espresso/dp/B009LIT6XQ/ref=cm\\_cr\\_ar\\_p\\_d\\_product\\_top?ie=UTF8](https://www.amazon.com/Kendall-Electric-Media-Fireplace-Espresso/dp/B009LIT6XQ/ref=cm_cr_ar_p_d_product_top?ie=UTF8)> (Year: 2012).\*

“Whalen Media Fireplace Console for TVs up to 70" Gray” Nov. 24, 2015, walmart.com, site visited Mar. 6, 2018 <<https://www.walmart.com/ip/Whalen-Media-Fireplace-Console-for-TVs-up-to-70-Gray/54189794>> (Year: 2015).\*

“Boston Loft Furnishings. . . ” Nov. 7, 2016, themine.com, site visited Mar. 2, 2018 <[http://www.themine.com/tv-stands/boston-loft-furnishings-reamrock-infrared-electric-fireplace-media-stand-with-convertible-corner\\_g2733659.html](http://www.themine.com/tv-stands/boston-loft-furnishings-reamrock-infrared-electric-fireplace-media-stand-with-convertible-corner_g2733659.html)>(Year: 2016).

“Ameriwood Home Everett 70-inch . . . ” Dec. 6, 2016, overstock.com, site visited Mar. 2, 2018 <<https://www.overstock.com/Home-Garden/Ameriwood-Home-Everett-70-inch-Sonoma-Oak-TV-Stand-with-Glass-Doors/12710691/product.html>>(Year: 2016).\*

Metal Coffee Table; <https://www.overstock.com/Home-Garden/42-Metal-Coffee-Table-42-x-24-x-18h/15951452/product.html> Retrieved on Nov. 13, 2018.

Modern Two-Tone Writing Desk; <https://www.overstock.com/Home-Garden/44-Modern-Two-Tone-Writing-Desk/19684325/product.html> Retrieved on Nov. 13, 2018.

Czapla TV Stand for TVs up to 65"; <https://www.allmodern.com/furniture/pdp/mercury-row-czapla-tv-stand-for-tvs-up-to-65-a000303456.html> ; Retrieved on May 7, 2019.

Nelson Media Cabinet; <https://www.franceandson.com/collections/storage-shelving-media-cabinets/products/nelson-media-cabinet36051> ; Retrieved on May 7, 2019.

Hal TV Stand for TVs up to 60"; <https://www.allmodern.com/furniture/pdp/hal-tv-stand-for-tvs-up-to-60-a000176456.html> ; Retrieved on May 7, 2019.

Wigington TV Stand for TVs up to 60"; <https://www.allmodern.com/furniture/pdp/wigington-tv-stand-for-tvs-up-to-60-golv3670.html?piid> ; Retrieved on May 7, 2019.

Audrey Woven Media Console 65"; <https://www.zinhome.com/audrey-woven-media-console-65/> ; Retrieved on May 14, 2019.

Cliffmay Slat Media Stand Light Oak Brown—Project 62; [https://www.target.com/p/cliffmay-slat-media-stand-light-oak-brown-project-62-153/-/A-53517373?ref=tgt\\_adv\\_XS000000&AFID=google\\_pla\\_df&fndsrc=tgtao&CPNG=PLA\\_Furniture%2BShopping\\_Priority%2BBrands&adgroup=SC\\_Project+62&LID=700000001170770pgs&network=g&device=c&location=9029756&gclid=aw.ds&ds\\_rl=1246978&ds\\_rl=1246978&ds\\_rl=1246978&ref=tgt\\_adv\\_XS000000&AFID=google\\_pla\\_df&CPNG=PLA\\_Furniture+Shopping\\_Priority+Brands&adgroup=SC\\_Project%2062&LID=700000001170770pgs&network=g&device=c&location=9029756&gclid=EAlalQobChMI7Nb9wo-H3wIVBylpCh1fSg4IEAQYBSABEGK\\_yPD\\_BwE&gclid=aw.ds](https://www.target.com/p/cliffmay-slat-media-stand-light-oak-brown-project-62-153/-/A-53517373?ref=tgt_adv_XS000000&AFID=google_pla_df&fndsrc=tgtao&CPNG=PLA_Furniture%2BShopping_Priority%2BBrands&adgroup=SC_Project+62&LID=700000001170770pgs&network=g&device=c&location=9029756&gclid=aw.ds&ds_rl=1246978&ds_rl=1246978&ds_rl=1246978&ref=tgt_adv_XS000000&AFID=google_pla_df&CPNG=PLA_Furniture+Shopping_Priority+Brands&adgroup=SC_Project%2062&LID=700000001170770pgs&network=g&device=c&location=9029756&gclid=EAlalQobChMI7Nb9wo-H3wIVBylpCh1fSg4IEAQYBSABEGK_yPD_BwE&gclid=aw.ds) ; Retrieved on May 7, 2019.

Demilune Mesh Door Industrial Sideboard; [https://belleescape.com/demilune-mesh-wire-door-industrial-chic-sideboard.html?\\_\\_SID=U](https://belleescape.com/demilune-mesh-wire-door-industrial-chic-sideboard.html?__SID=U) ; Retrieved on May 7, 2019.

Tuk Cabinet; <https://blackroosterdecor.com/collections/storage/products/tuk-cabinet> ; Retrieved on May 14, 2019.

Rustic Style 31 Inches Metal TV Stand With Wire Mesh Doors Cabinet, Black; <https://casagear.com/products/rustic-style-31-indies-metal-tv-stand-with-wire-mesh-doors-cabinet-black>; May 14, 2019.

Geo-Marquetry Buffet; [https://www.anthropologie.com/shop/geo-marquetry-buffet?adpos=1o27&adtype=pla&cm\\_mmc=Google-US%20Shopping%20-%20Furniture-Organizing%20and%20Storage-42699934&color=&countryCode=US&creative=191389729567&device=c&gclid=EAlalQobChMlvuTGgYOH3wIVEdNkCh3t8wRPEAkYGyABEGJG\\_PD\\_BwE&inventoryCountry=US&matchtype=&mrkgadid=3202938336&mrkgclid=694&network=g&product\\_id=42699934&quantity=1&size=ALL&type=STANDARD&utm\\_campaign=US%20-%20Shopping%20-%20Furniture&utm\\_content=42699934&utm\\_medium=paid\\_search&utm\\_source=Google&utm\\_term=Organizing%20and%20Storage](https://www.anthropologie.com/shop/geo-marquetry-buffet?adpos=1o27&adtype=pla&cm_mmc=Google-US%20Shopping%20-%20Furniture-Organizing%20and%20Storage-42699934&color=&countryCode=US&creative=191389729567&device=c&gclid=EAlalQobChMlvuTGgYOH3wIVEdNkCh3t8wRPEAkYGyABEGJG_PD_BwE&inventoryCountry=US&matchtype=&mrkgadid=3202938336&mrkgclid=694&network=g&product_id=42699934&quantity=1&size=ALL&type=STANDARD&utm_campaign=US%20-%20Shopping%20-%20Furniture&utm_content=42699934&utm_medium=paid_search&utm_source=Google&utm_term=Organizing%20and%20Storage); Retrieved on May 14, 2019.

Suspend II Media Console; <https://www.cb2.com/suspend-ii-media-console/s523915>; Retrieved on May 14, 2019.

Hooker Furniture Melange Mirrored Angle Console; [https://www.furniturecrate.com/hooker-melange-mirrored-angle-console.html?gdftrk=gdfV21650\\_a\\_7c92\\_a\\_7c8357\\_a\\_7c654170&gclid=CjwKEAiA05unBRCymrGilanF9SwSjACqDFRm1WwgePUSp65sXRCI4RkJfScYn-yCjNuB-GTt3W-FxoCQL7w\\_wcB](https://www.furniturecrate.com/hooker-melange-mirrored-angle-console.html?gdftrk=gdfV21650_a_7c92_a_7c8357_a_7c654170&gclid=CjwKEAiA05unBRCymrGilanF9SwSjACqDFRm1WwgePUSp65sXRCI4RkJfScYn-yCjNuB-GTt3W-FxoCQL7w_wcB); Retrieved on May 14, 2019.

FurnitureMaxx Besteen Contemporary Wood Dark Gray Dining Room Server; [https://www.amazon.com/dp/B07GVS1VK2/ref=cm\\_sw\\_r\\_pi\\_dp\\_U\\_x\\_evuOBbFM3298G](https://www.amazon.com/dp/B07GVS1VK2/ref=cm_sw_r_pi_dp_U_x_evuOBbFM3298G); Retrieved on May 14, 2019.

Jaydyn Media TV Stand/Credenza; [https://www.macys.com/shop/product/jaydyn-media-tv-stand-credenza?ID=2883210&CategoryID=35319#fn=FURNITURE\\_CATEGORY=Buffet%20&mp;20Sideboards&SIZE=&sp=3&spc=131&ruleId=129%7CBOOST%20ATTRIBUTE%7CBOOST%20SAVED%20SET&searchPass=matchNone&slotId=2](https://www.macys.com/shop/product/jaydyn-media-tv-stand-credenza?ID=2883210&CategoryID=35319#fn=FURNITURE_CATEGORY=Buffet%20&mp;20Sideboards&SIZE=&sp=3&spc=131&ruleId=129%7CBOOST%20ATTRIBUTE%7CBOOST%20SAVED%20SET&searchPass=matchNone&slotId=2); Retrieved on May 14, 2019.

Sideboard; <https://www.allmodern.com/furniture/pdp/sideboard-sct11710.html>; Retrieved on May 14, 2019.

Belham Living Trenton Industrial End Table; [https://www.hayneedle.com/product/belham-living-trenton-industrial-end-table-new.cfm?source=pla&kwid=OccasionalTables%20iprefer&tid=REDU113-1&adtype=pla&kw=&gclid=EAlalQobChMlvOu-6vel3wIVB8ZkCh0ZdAf-EAkYAyABEGLyMfD\\_BwE](https://www.hayneedle.com/product/belham-living-trenton-industrial-end-table-new.cfm?source=pla&kwid=OccasionalTables%20iprefer&tid=REDU113-1&adtype=pla&kw=&gclid=EAlalQobChMlvOu-6vel3wIVB8ZkCh0ZdAf-EAkYAyABEGLyMfD_BwE); Retrieved on May 15, 2019.

Belham Living Hampton Chair Side Table—Black; <https://www.hayneedle.com/product/belham-living-hampton-chair-side-table-black.cfm>; Retrieved on May 15, 2019.

International Concepts Hampton End Table; [https://www.hayneedle.com/product/internationalconceptshamptonendtable.cfm?source=pla&kwid=OccasionalTables%20level05&tid=WWI545-1&adtype=pla&kw=&gclid=EAlalQobChMIpsnoq\\_ml3wIVGNVCh348gtdEAKYliABEGLP7fD\\_BwE](https://www.hayneedle.com/product/internationalconceptshamptonendtable.cfm?source=pla&kwid=OccasionalTables%20level05&tid=WWI545-1&adtype=pla&kw=&gclid=EAlalQobChMIpsnoq_ml3wIVGNVCh348gtdEAKYliABEGLP7fD_BwE); Retrieved on May 15, 2019.

Hampton Weathered Taupe Gray Coffee Table; [https://www.homedepot.com/p/International-Concepts-Hampton-Weathered-Taupe-Gray-Coffee-Table-OT09-70C/302946359?MERCH=REC-PIPHorizontal2\\_rr\\_-204737265\\_-302946359\\_-N](https://www.homedepot.com/p/International-Concepts-Hampton-Weathered-Taupe-Gray-Coffee-Table-OT09-70C/302946359?MERCH=REC-PIPHorizontal2_rr_-204737265_-302946359_-N); Retrieved on May 15, 2019.

Convenience Concepts Oxford Rectangle Coffee Table; [https://www.hayneedle.com/product/convenience-concepts-oxford-rectangle-coffee-table.cfm?source=pla&kwid=OccasionalTables%20newskus&tid=CONV338-5&adtype=pla&kw=&gclid=EAlalQobChMIhuzv9\\_ml3wIVVWx-tBh1rUA1tEAKYHyABEGJ2hPD\\_BwE](https://www.hayneedle.com/product/convenience-concepts-oxford-rectangle-coffee-table.cfm?source=pla&kwid=OccasionalTables%20newskus&tid=CONV338-5&adtype=pla&kw=&gclid=EAlalQobChMIhuzv9_ml3wIVVWx-tBh1rUA1tEAKYHyABEGJ2hPD_BwE); Retrieved on May 15, 2019.

Belham Living Jamestown Rustic Coffee Table with Unique Driftwood Finish; <https://www.hayneedle.com/product/jamestown-rustic-coffee-table.cfm>; Retrieved on May 15, 2019.

U.S. Appl. No. 29/654,936, dated Jun. 19, 2019, Notice of Allowance.

U.S. Appl. No. 29/564,479, dated Jun. 27, 2019, Notice of Allowance.

(56)

**References Cited**

OTHER PUBLICATIONS

Pinterest; [www.pinterest.com/pin/336328451393621/](http://www.pinterest.com/pin/336328451393621/); Retrieved on Jun. 12, 2019.

Target Winham TV Stand—Threshold; [www.target.com/p/windham-tv-stand-threshold-153/-/A-54301349](http://www.target.com/p/windham-tv-stand-threshold-153/-/A-54301349); Retrieved on Jun. 12, 2019.

Pinterest DIY Farmhouse Coffee Table Cabinet; [www.pinterest.com/pin/33636328450994833/](http://www.pinterest.com/pin/33636328450994833/); Retrieved on Jun. 12, 2019.

Image seen on Pinterest DIY Project; Pinterest.com; Seen approximately Aug. 1, 2017.

World Market—Metal Bexley Bar; [www.worldmarket.com/product/metal+bexley+bar.do?pp=1](http://www.worldmarket.com/product/metal+bexley+bar.do?pp=1); Retrieved on Sep. 25, 2019.

Overstock—Nova Domus Soria Modern Walnut TV Stand; [https://www.overstock.com/Home-Garden/Nova-Domus-Soria-Modern-Walnut-TV-Stand/10359356/product.html?utm\\_campaign=pin\\_button&utm\\_medium=Social&utm\\_source=Pinterest](https://www.overstock.com/Home-Garden/Nova-Domus-Soria-Modern-Walnut-TV-Stand/10359356/product.html?utm_campaign=pin_button&utm_medium=Social&utm_source=Pinterest); Retrieved on Jun. 12, 2019.

Restriction Requirement for U.S. Appl. No. 29/654,950 dated Sep. 25, 2019.

Office Action for U.S. Appl. No. 29/656,489 dated Sep. 25, 2019.

Office Action for U.S. Appl. No. 29/656,497 dated Sep. 25, 2019.

Office Action for U.S. Appl. No. 29/656,499 dated Sep. 26, 2019.

Notice of Allowance for U.S. Appl. No. 29/656,486 dated Sep. 27, 2019.

Notice of Allowance for U.S. Appl. No. 29/656,485 dated Oct. 2, 2019.

Notice of Allowance for U.S. Appl. No. 29/656,479 dated Oct. 21, 2019.

\* cited by examiner

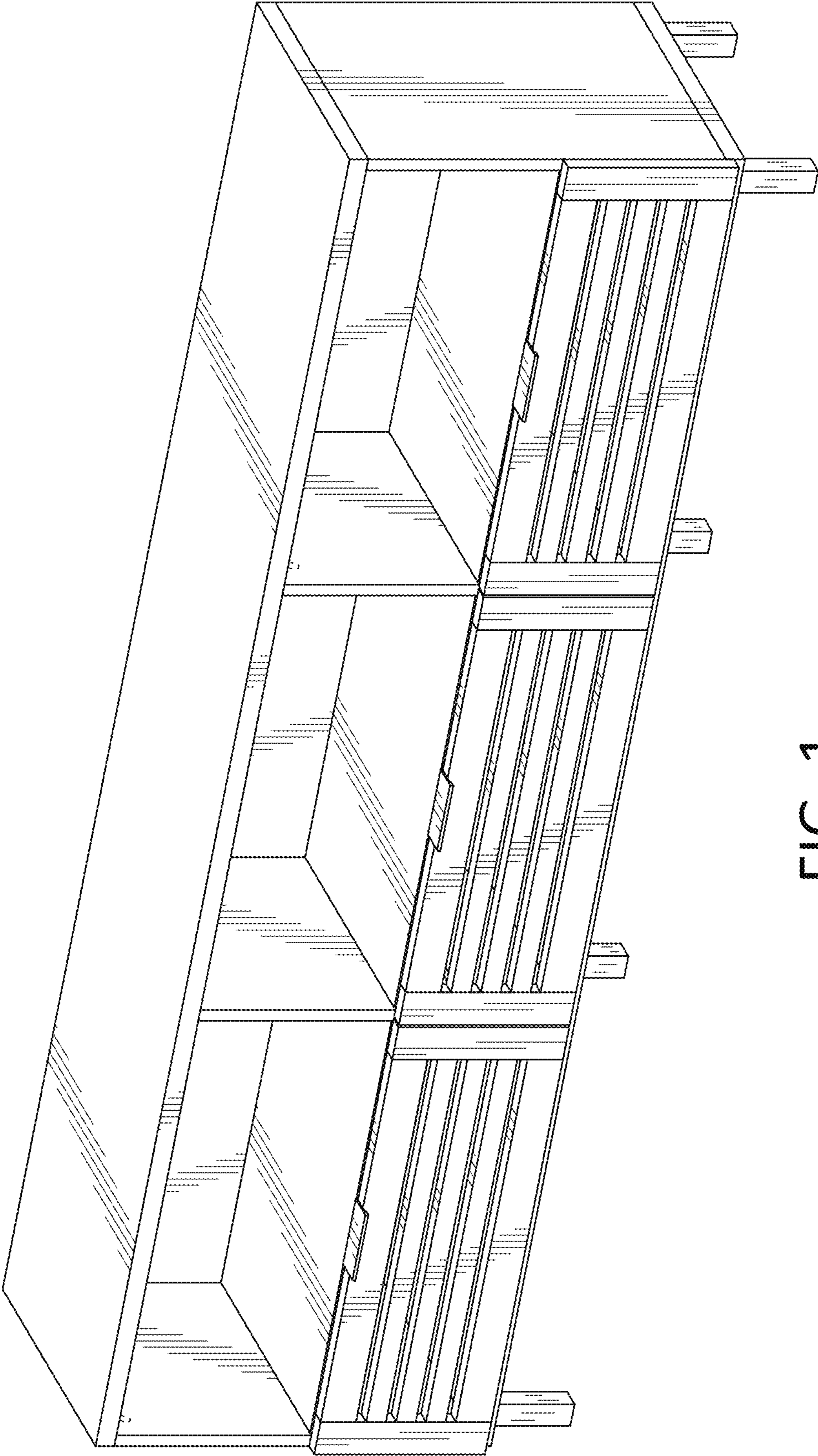

FIG. 1

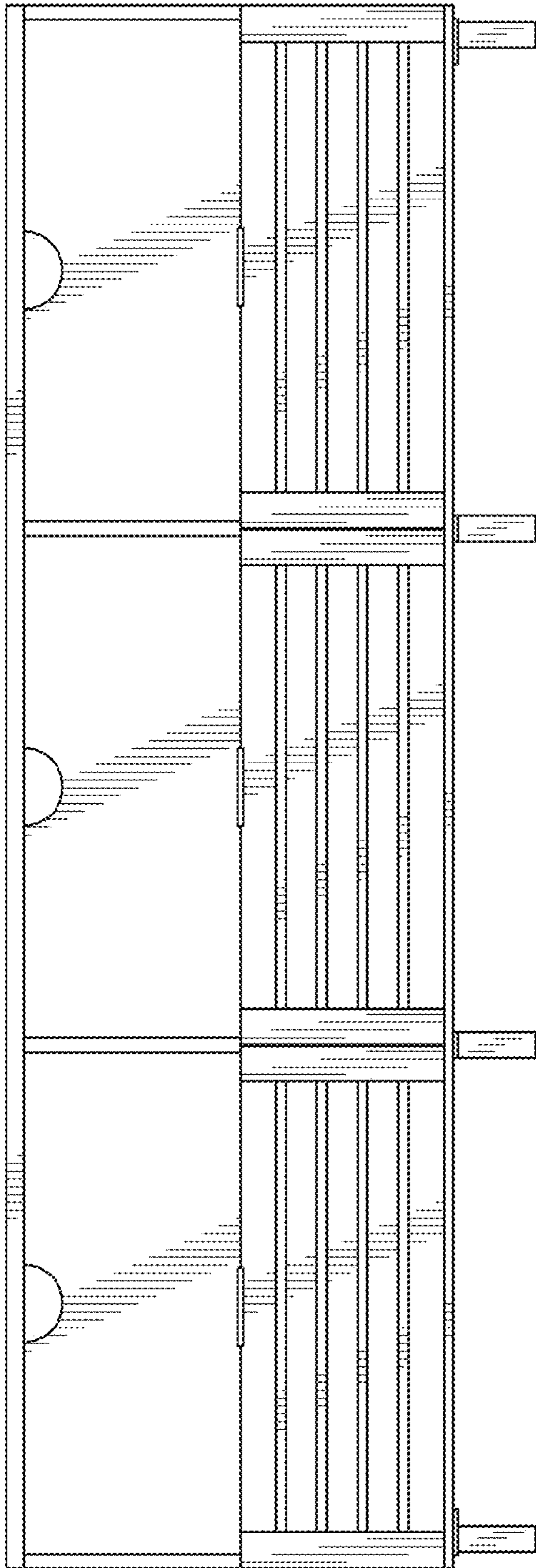

FIG. 2

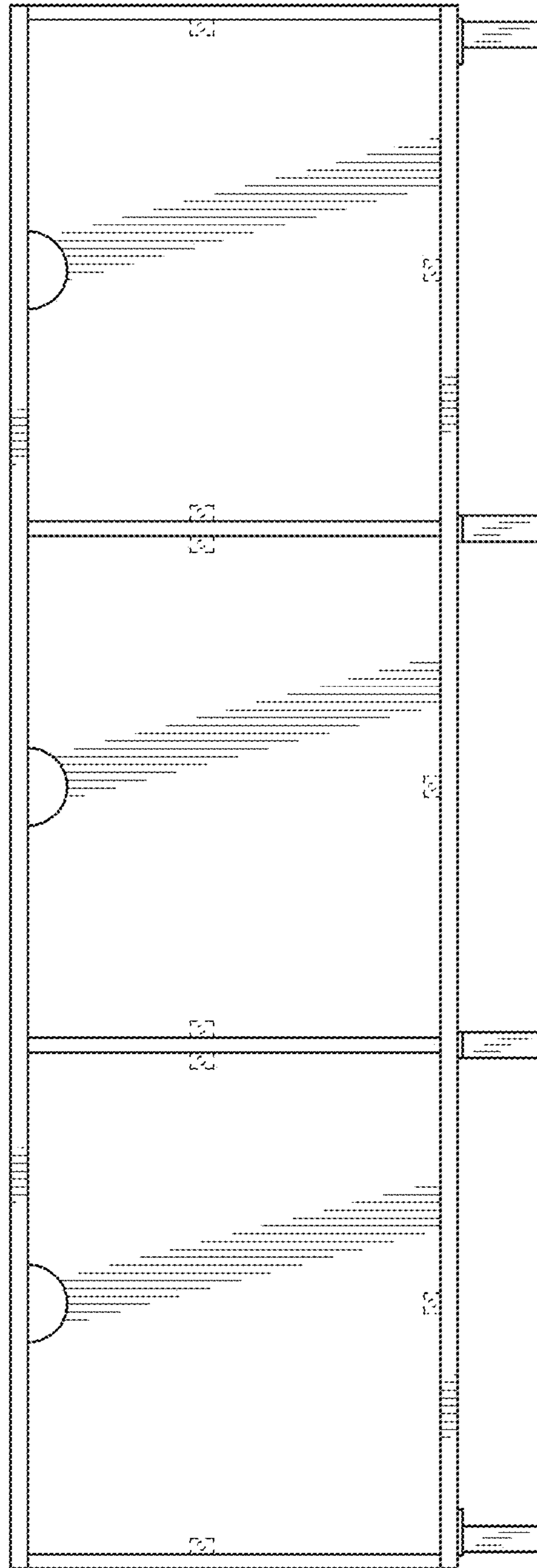

FIG. 3



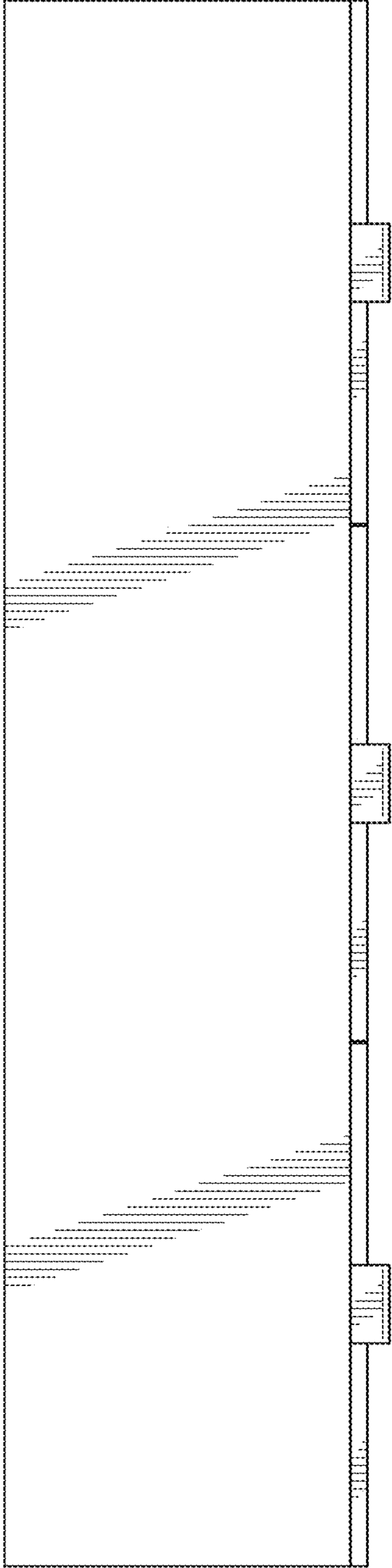

FIG. 4

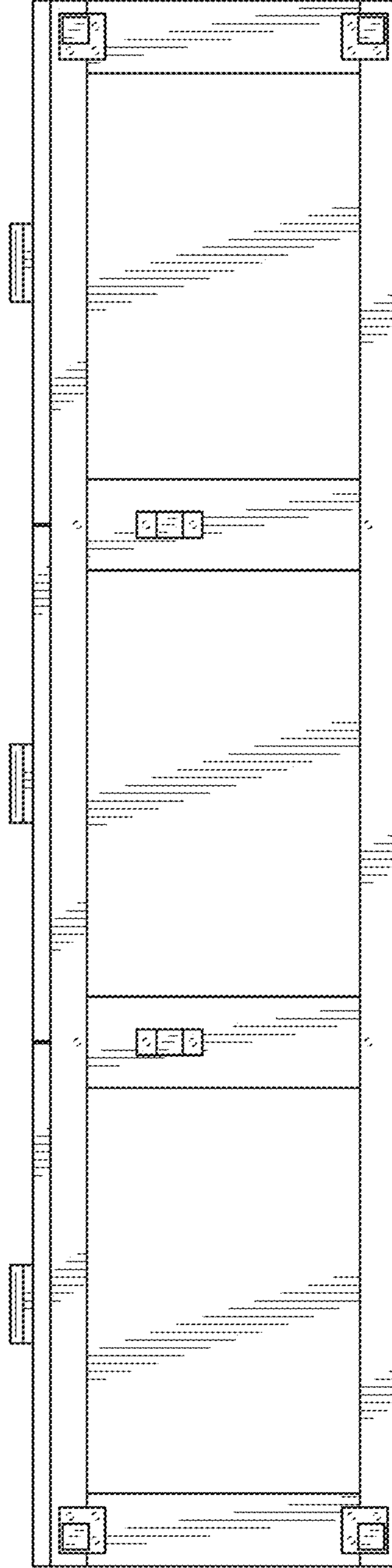

FIG. 5

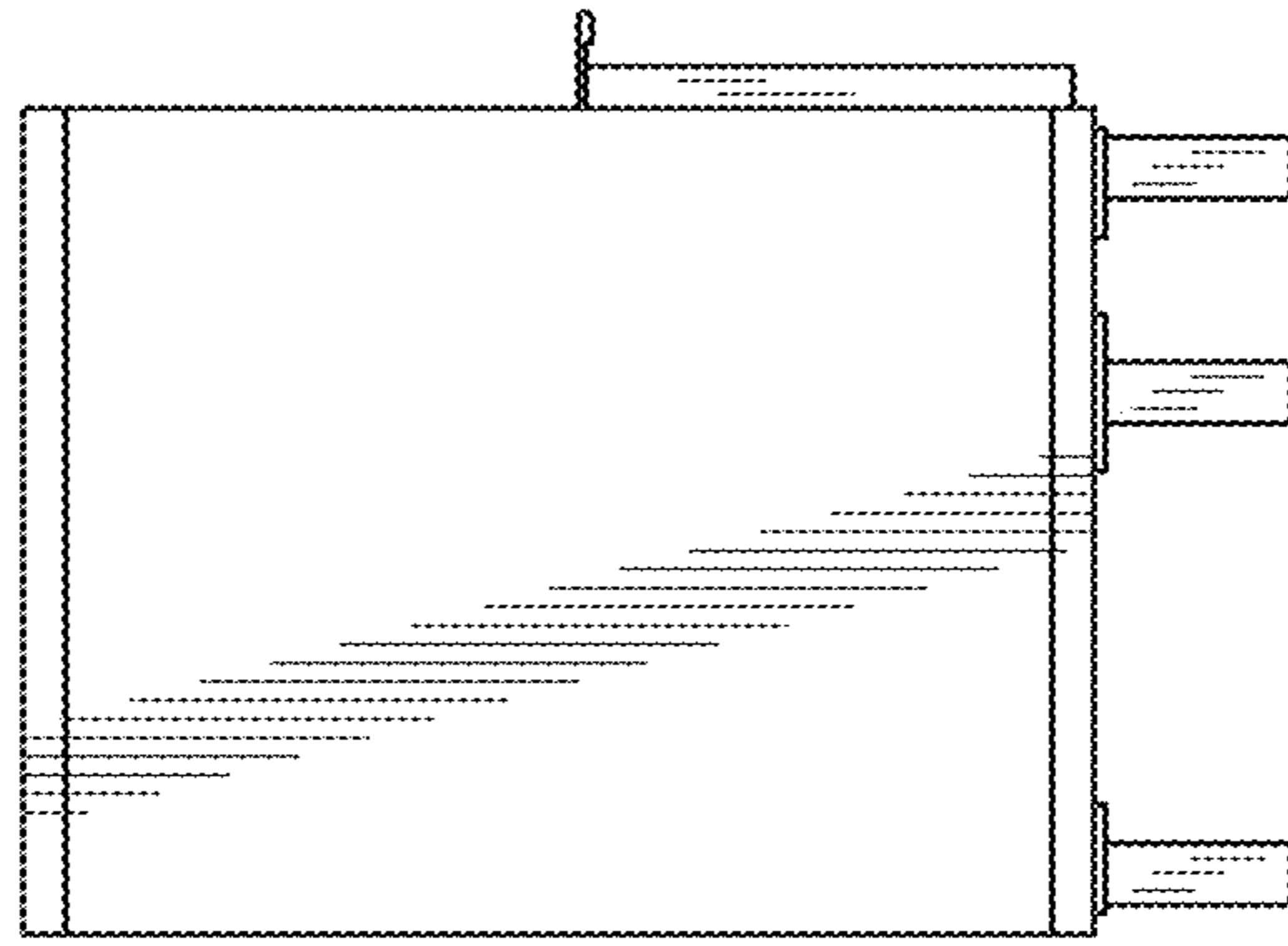

FIG. 6

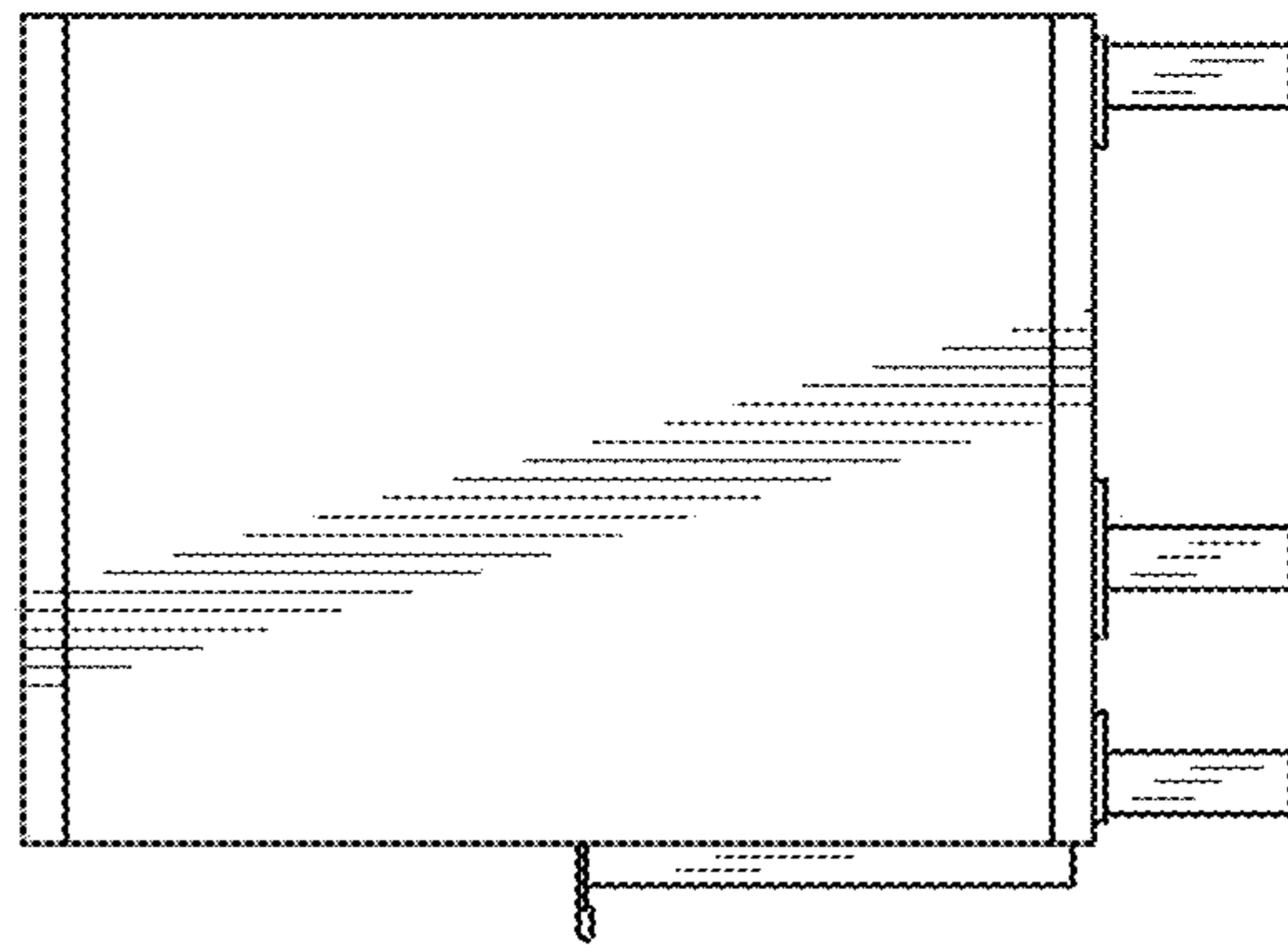

FIG. 7